

### General Description

- Trench Power AlphaMOS (αMOS LV) technology
- Low  $R_{SS(ON)}$
- With ESD protection to improve battery performance and safety
- Common drain configuration for design simplicity
- RoHS and Halogen-Free Compliant

### Applications

- Battery protection switch
- Mobile device battery charging and discharging

### Product Summary

$V_{SS}$	20V
$I_S$ (at $V_{GS}=4.5V$ )	4.5A
$R_{SS(ON)}$ (at $V_{GS}=4.5V$ )	< 18mΩ
$R_{SS(ON)}$ (at $V_{GS}=4.0V$ )	< 20mΩ
$R_{SS(ON)}$ (at $V_{GS}=3.7V$ )	< 21mΩ
$R_{SS(ON)}$ (at $V_{GS}=3.1V$ )	< 23mΩ
$R_{SS(ON)}$ (at $V_{GS}=2.5V$ )	< 29mΩ

### Typical ESD protection

**HBM Class 3A**

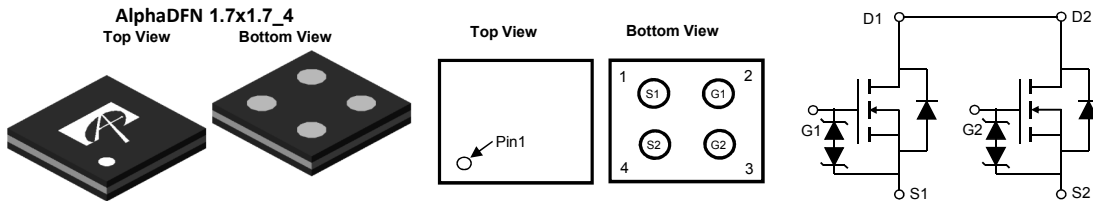

Orderable Part Number	Package Type	Form	Minimum Order Quantity
AOC2806	AlphaDFN 1.7x1.7_4	Tape & Reel	3000

### Absolute Maximum Ratings $T_A=25^\circ C$ unless otherwise noted

Parameter	Symbol	Maximum	Units
Source-Source Voltage	$V_{SS}$	20	V
Gate-Source Voltage	$V_{GS}$	$\pm 12$	V
Source Current(DC) <sup>Note1</sup>	$I_S$	4.5	A
Source Current(Pulse) <sup>Note2</sup>	$I_{SM}$	18	
Power Dissipation <sup>Note1</sup>	$P_D$	0.7	W
Junction and Storage Temperature Range	$T_J, T_{STG}$	-55 to 150	$^\circ C$

### Thermal Characteristics

Parameter	Symbol	Typ	Max	Units
Maximum Junction-to-Ambient $t \leq 10s$	$R_{\theta JA}$	115	140	$^\circ C/W$
Maximum Junction-to-Ambient Steady-State		140	180	$^\circ C/W$

**Note 1.** Mounted on 1in2 FR-4 board with 2oz. Copper.

**Note 2.** PW <300  $\mu s$  pulses, duty cycle 0.5% max

**Electrical Characteristics (T<sub>J</sub>=25°C unless otherwise noted)**

Symbol	Parameter	Conditions	Min	Typ	Max	Units
<b>STATIC PARAMETERS</b>						
BV <sub>SSS</sub>	Source-Source Breakdown Voltage	I <sub>S</sub> =250μA, V <sub>GS</sub> =0V Test Circuit 6	20			V
I <sub>SSS</sub>	Zero Gate Voltage Source Current	V <sub>SS</sub> =20V, V <sub>GS</sub> =0V Test Circuit 1 T <sub>J</sub> =55°C			1 5	μA
I <sub>GSS</sub>	Gate leakage current	V <sub>SS</sub> =0V, V <sub>GS</sub> =±10V Test Circuit 2			±10	μA
V <sub>GS(th)</sub>	Gate Threshold Voltage	V <sub>SS</sub> =V <sub>GS</sub> , I <sub>S</sub> =250μA Test Circuit 3	0.5	0.85	1.3	V
R <sub>SS(ON)</sub>	Static Source to Source On-Resistance	V <sub>GS</sub> =4.5V, I <sub>S</sub> =3A Test Circuit 4 T <sub>J</sub> =125°C	10	15	18	mΩ
			14	20.5	25	
		V <sub>GS</sub> =4.0V, I <sub>S</sub> =3A Test Circuit 4	11	15.8	20	mΩ
		V <sub>GS</sub> =3.7V, I <sub>S</sub> =3A Test Circuit 4	11.5	16.3	21	mΩ
		V <sub>GS</sub> =3.1V, I <sub>S</sub> =3A Test Circuit 4	12.5	17.6	23	mΩ
	V <sub>GS</sub> =2.5V, I <sub>S</sub> =3A Test Circuit 4	14.5	21	29	mΩ	
g <sub>FS</sub>	Forward Transconductance	V <sub>SS</sub> =5V, I <sub>S</sub> =3A Test Circuit 3		16		S
V <sub>FSS</sub>	Forward Source to Source Voltage	I <sub>S</sub> =1A, V <sub>GS</sub> =0V Test Circuit 5		0.68	1	V
<b>DYNAMIC PARAMETERS</b>						
R <sub>g</sub>	Gate resistance	f=1MHz		2		KΩ
<b>SWITCHING PARAMETERS</b>						
Q <sub>g</sub>	Total Gate Charge	V <sub>G1S1</sub> =4.5V, V <sub>SS</sub> =10V, I <sub>S</sub> =3A		12.5		nC
t <sub>D(on)</sub>	Turn-On DelayTime	V <sub>G1S1</sub> =4.5V, V <sub>SS</sub> =10V, R <sub>L</sub> =3.3Ω, R <sub>GEN</sub> =3Ω Test Circuit8		1.0		μs
t <sub>r</sub>	Turn-On Rise Time			3.0		μs
t <sub>D(off)</sub>	Turn-Off DelayTime			2.1		μs
t <sub>f</sub>	Turn-Off Fall Time			8.8		μs

THIS PRODUCT HAS BEEN DESIGNED AND QUALIFIED FOR THE CONSUMER MARKET. APPLICATIONS OR USES AS CRITICAL COMPONENTS IN LIFE SUPPORT DEVICES OR SYSTEMS ARE NOT AUTHORIZED. AOS DOES NOT ASSUME ANY LIABILITY ARISING OUT OF SUCH APPLICATIONS OR USES OF ITS PRODUCTS. AOS RESERVES THE RIGHT TO IMPROVE PRODUCT DESIGN, FUNCTIONS AND RELIABILITY WITHOUT NOTICE.

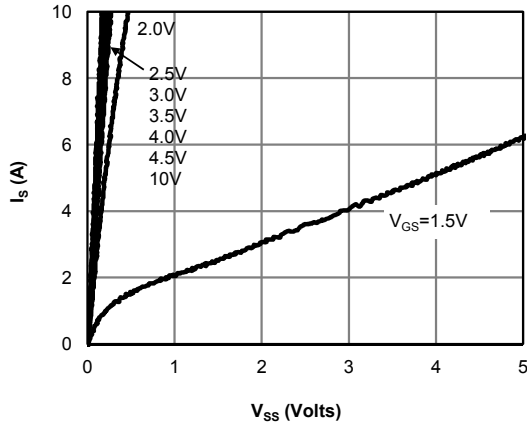
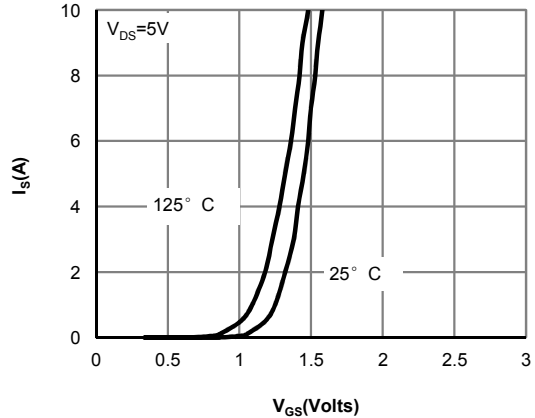
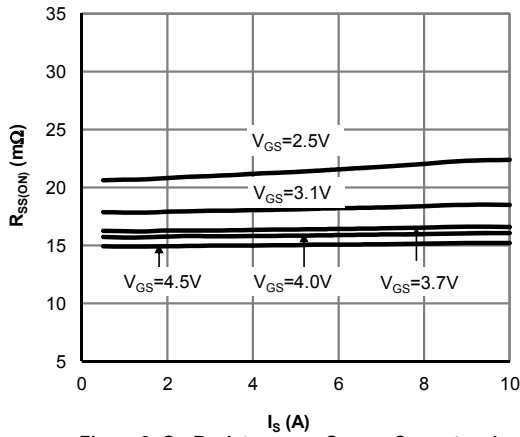
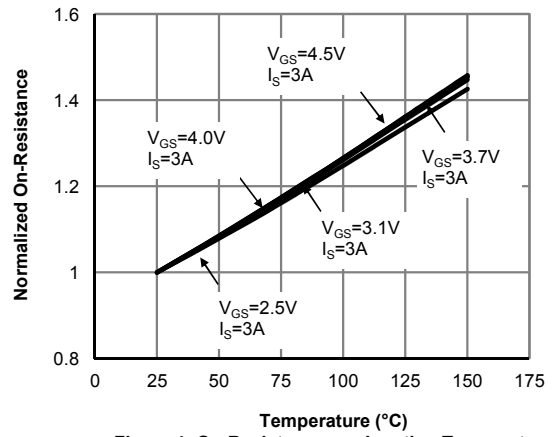
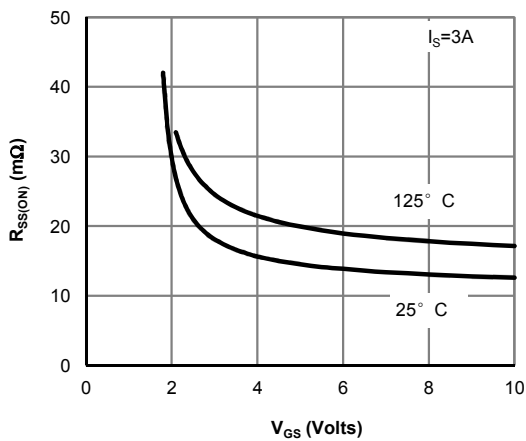
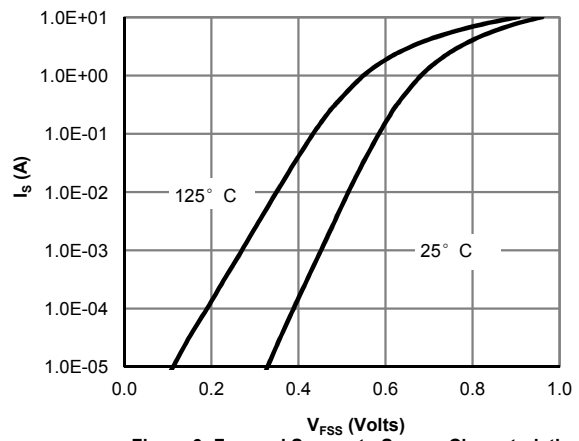
**TYPICAL ELECTRICAL AND THERMAL CHARACTERISTICS**

**Figure 1: On-Region Characteristics**

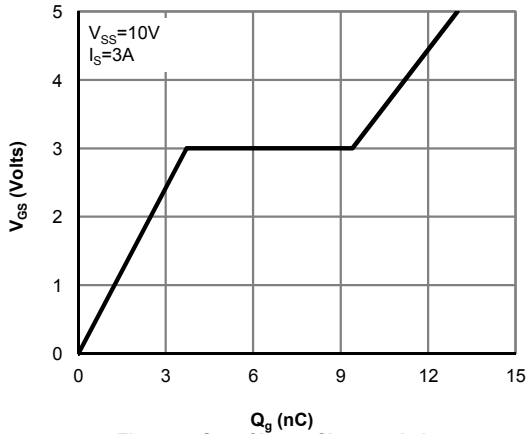
**Figure 2: Transfer Characteristics**

**Figure 3: On-Resistance vs. Source Current and Gate Voltage**

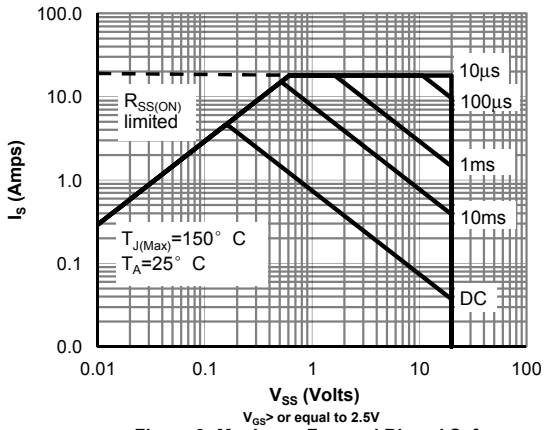
**Figure 4: On-Resistance vs. Junction Temperature**

**Figure 5: On-Resistance vs. Gate-Source Voltage**

**Figure 6: Forward Source to Source Characteristics**

**TYPICAL ELECTRICAL AND THERMAL CHARACTERISTICS**



**Figure 7: Gate-Charge Characteristics**



**Figure 9: Maximum Forward Biased Safe Operating Area (Note1)**

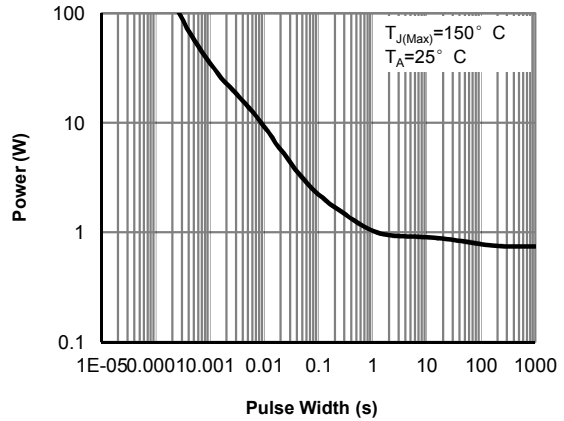

**Figure 10: Single Pulse Power Rating Junction-to-Ambient (Note1)**

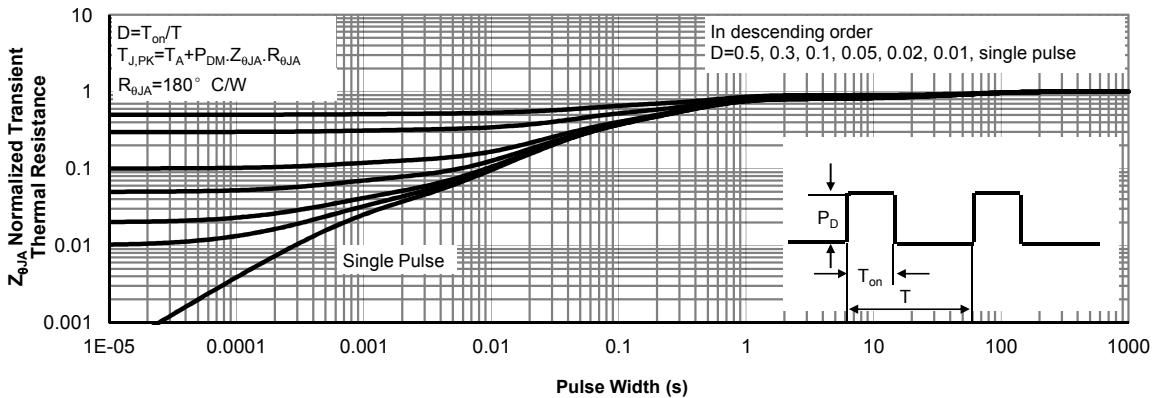

**Figure 11: Normalized Maximum Transient Thermal Impedance (Note1)**

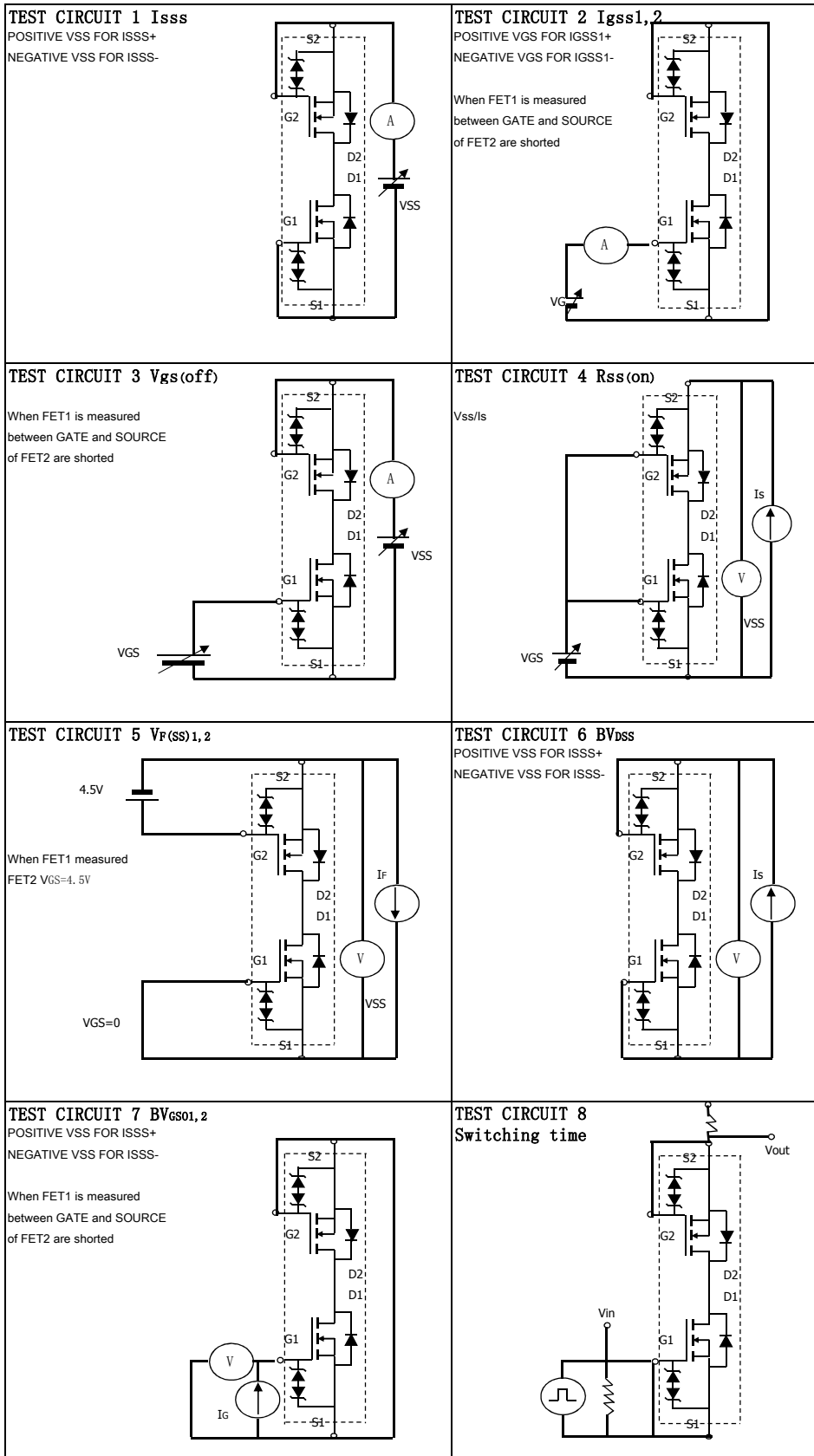

## X-ON Electronics

Largest Supplier of Electrical and Electronic Components

*Click to view similar products for [MOSFET](#) category:*

*Click to view products by [Alpha & Omega](#) manufacturer:*

Other Similar products are found below :

[614233C](#) [648584F](#) [IRFD120](#) [JANTX2N5237](#) [2N7000](#) [FCA20N60\\_F109](#) [FDZ595PZ](#) [2SK2545\(Q,T\)](#) [405094E](#) [423220D](#)  
[TPCC8103,L1Q\(CM](#) [MIC4420CM-TR](#) [VN1206L](#) [614234A](#) [715780A](#) [NTNS3166NZT5G](#) [SSM6J414TU,LF\(T](#) [751625C](#) [IPP110N20N3GXX](#)  
[IPS70R2K0CEAKMA1](#) [DMN3404LQ-7](#) [NTE6400](#) [2SK2614\(TE16L1,Q\)](#) [DMN1017UCP3-7](#) [EFC2J004NUZTDG](#) [ECH8691-TL-W](#)  
[FCAB21350L1](#) [P85W28HP2F-7071](#) [DMN1053UCP4-7](#) [NTE221](#) [NTE2384](#) [NTE2903](#) [NTE2941](#) [NTE2945](#) [NTE2946](#) [NTE2960](#) [NTE2969](#)  
[NTE2976](#) [NTE455](#) [NTE6400A](#) [NTE2910](#) [NTE2916](#) [NTE2956](#) [NTE2911](#) [TK10A80W,S4X\(S](#) [SSM6P69NU,LF](#) [DMP22D4UFO-7B](#)  
[DMN1006UCA6-7](#) [DMN16M9UCA6-7](#) [STF5N65M6](#)