



### General Description

- Latest Alpha IGBT ( $\alpha$ IGBT) technology
- Best in Class  $V_{CE(sat)}$  enables high efficiencies
- Low turn-off switching loss due to fast turn-off time
- Very smooth turn-off current waveforms reduce EMI
- Better thermal management
- High surge current capability
- Minimal gate spike due to high input capacitance

### Applications

- Induction Cooking
- Rice Cookers
- Microwave Ovens
- Other soft switching applications

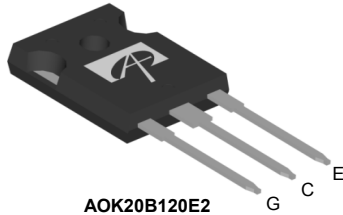
### Product Summary

$V_{CE}$	1200V
$I_C$ ( $T_C=100^\circ\text{C}$ )	20A
$V_{CE(sat)}$ ( $T_C=25^\circ\text{C}$ )	1.75V

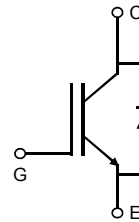


Top View

TO-247



AOK20B120E2



Orderable Part Number	Package Type	Form	Minimum Order Quantity
AOK20B120E2	TO247	Tube	240
<b>Absolute Maximum Ratings <math>T_A=25^\circ\text{C}</math> unless otherwise noted</b>			
Parameter	Symbol	AOK20B120E2	Units
Collector-Emitter Voltage	$V_{CE}$	1200	V
Gate-Emitter Voltage	$V_{GE}$	$\pm 30$	V
Continuous Collector Current	$I_C$	$T_C=25^\circ\text{C}$	40
		$T_C=100^\circ\text{C}$	20
Pulsed Collector Current, Limited by $T_{Jmax}$	$I_{Cpulse}$	80	A
Non repetitive peak collector current <sup>A</sup>	$I_{CSM}$	200	A
Turn off SOA, $V_{CE} \leq 600\text{V}$ , Limited by $T_{Jmax}$	$I_{LM}$	80	A
Continuous Diode Forward Current	$I_F$	$T_C=25^\circ\text{C}$	40
		$T_C=100^\circ\text{C}$	20
Diode Pulsed Current, Limited by $T_{Jmax}$	$I_{Fpulse}$	80	A
Power Dissipation	$P_D$	$T_C=25^\circ\text{C}$	250
		$T_C=100^\circ\text{C}$	125
Junction and Storage Temperature Range	$T_J, T_{STG}$	-55 to 175	$^\circ\text{C}$
Maximum lead temperature for soldering purpose, 1/8" from case for 5 seconds	$T_L$	300	$^\circ\text{C}$
<b>Thermal Characteristics</b>			
Parameter	Symbol	AOK20B120E2	Units
Maximum Junction-to-Ambient	$R_{\theta JA}$	40	$^\circ\text{C/W}$
Maximum IGBT Junction-to-Case	$R_{\theta JC}$	0.6	$^\circ\text{C/W}$
Maximum Diode Junction-to-Case	$R_{\theta JC}$	1.6	$^\circ\text{C/W}$

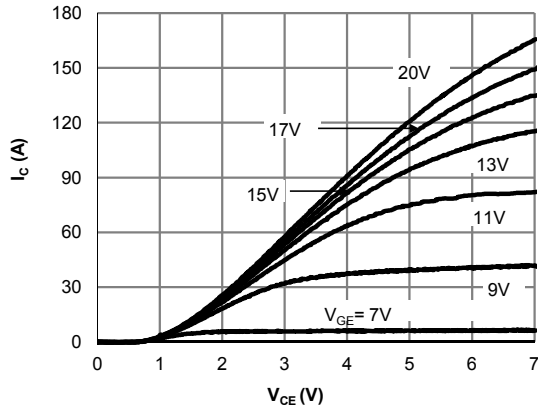
Note A: Capacitor charging saturation current limited by  $T_{Jmax} < 175^\circ\text{C}$  and  $t_p < 3\mu\text{s}$

**Electrical Characteristics (T<sub>J</sub>=25°C unless otherwise noted)**

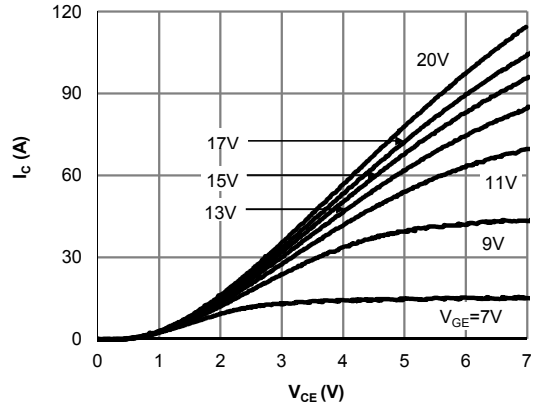
Symbol	Parameter	Conditions	Min	Typ	Max	Units	
<b>STATIC PARAMETERS</b>							
$V_{CES}$	Collector-Emitter Breakdown Voltage	$I_C=1mA, V_{GE}=0V, T_J=25^\circ C$	1200	-	-	V	
$V_{CE(sat)}$	Collector-Emitter Saturation Voltage	$V_{GE}=15V, I_C=20A$	$T_J=25^\circ C$	-	1.75	2.2	V
			$T_J=125^\circ C$	-	2.2	-	
			$T_J=175^\circ C$	-	2.3	-	
$V_F$	Diode Forward Voltage	$V_{GE}=0V, I_C=20A$	$T_J=25^\circ C$	-	1.6	2	V
			$T_J=125^\circ C$	-	2.3	-	
			$T_J=175^\circ C$	-	2.4	-	
$V_{GE(th)}$	Gate-Emitter Threshold Voltage	$V_{CE}=5V, I_C=1mA$	4.4	5.05	5.7	V	
$I_{CES}$	Zero Gate Voltage Collector Current	$V_{CE}=1200V, V_{GE}=0V$	$T_J=25^\circ C$	-	-	10	$\mu A$
			$T_J=125^\circ C$	-	-	500	
			$T_J=175^\circ C$	-	-	5000	
$I_{GES}$	Gate-Emitter leakage current	$V_{CE}=0V, V_{GE}=\pm 30V$	-	-	$\pm 100$	nA	
$g_{FS}$	Forward Transconductance	$V_{CE}=20V, I_C=20A$	-	22.5	-	S	
<b>DYNAMIC PARAMETERS</b>							
$C_{ies}$	Input Capacitance	$V_{GE}=0V, V_{CE}=25V, f=1MHz$	-	1445	-	pF	
$C_{oes}$	Output Capacitance		-	85	-	pF	
$C_{res}$	Reverse Transfer Capacitance		-	25	-	pF	
$Q_g$	Total Gate Charge	$V_{GE}=15V, V_{CE}=960V, I_C=20A$	-	53.5	-	nC	
$Q_{ge}$	Gate to Emitter Charge		-	12	-	nC	
$Q_{gc}$	Gate to Collector Charge		-	24.5	-	nC	
$R_g$	Gate resistance	$V_{GE}=0V, V_{CE}=0V, f=1MHz$	-	2.2	-	$\Omega$	
<b>SWITCHING PARAMETERS, (Load Inductive, T<sub>J</sub>=25°C)</b>							
$t_{D(off)}$	Turn-Off Delay Time	$T_J=25^\circ C$	-	123	-	ns	
$t_f$	Turn-Off Fall Time	$V_{GE}=15V, V_{CE}=600V, I_C=20A,$ $R_G=15\Omega,$	-	120	-	ns	
$E_{off}$	Turn-Off Energy	Parasitic Inductance=150nH	-	0.82	-	mJ	
<b>SWITCHING PARAMETERS, (Load Inductive, T<sub>J</sub>=175°C)</b>							
$t_{D(off)}$	Turn-Off Delay Time	$T_J=175^\circ C$	-	144	-	ns	
$t_f$	Turn-Off Fall Time	$V_{GE}=15V, V_{CE}=600V, I_C=20A,$ $R_G=15\Omega,$	-	170	-	ns	
$E_{off}$	Turn-Off Energy	Parasitic Inductance=150nH	-	1.32	-	mJ	

THIS PRODUCT HAS BEEN DESIGNED AND QUALIFIED FOR THE CONSUMER MARKET. APPLICATIONS OR USES AS CRITICAL COMPONENTS IN LIFE SUPPORT DEVICES OR SYSTEMS ARE NOT AUTHORIZED. AOS DOES NOT ASSUME ANY LIABILITY ARISING OUT OF SUCH APPLICATIONS OR USES OF ITS PRODUCTS. AOS RESERVES THE RIGHT TO IMPROVE PRODUCT DESIGN, FUNCTIONS AND RELIABILITY WITHOUT NOTICE.

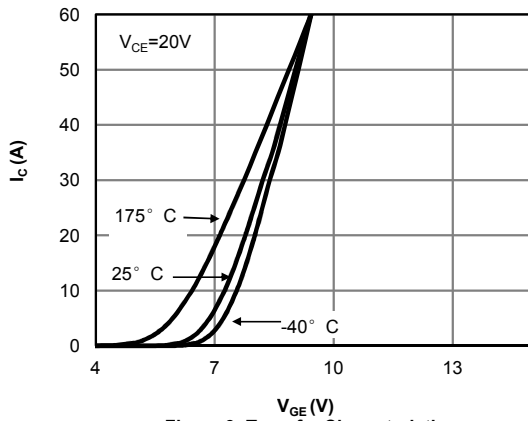
**TYPICAL ELECTRICAL AND THERMAL CHARACTERISTICS**



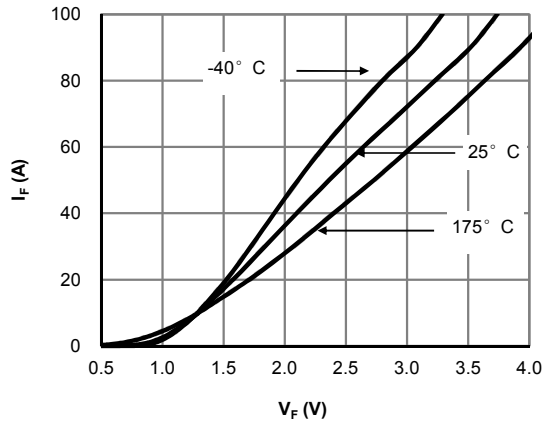
**Figure 1: Output Characteristic**  
( $T_j=25^\circ\text{C}$ )



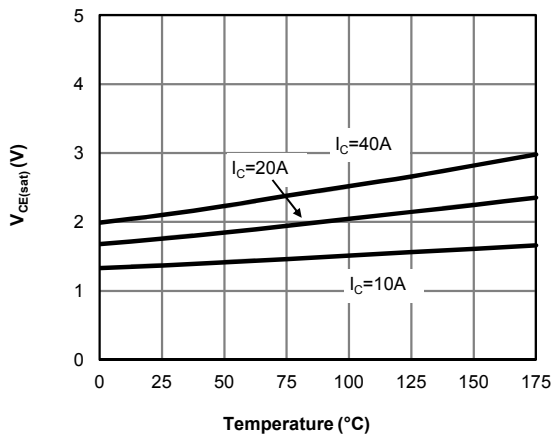
**Figure 2: Output Characteristic**  
( $T_j=175^\circ\text{C}$ )



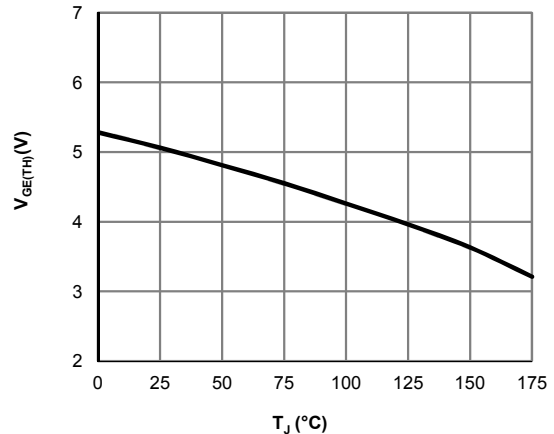
**Figure 3: Transfer Characteristic**



**Figure 4: Diode Characteristic**



**Figure 5: Collector-Emitter Saturation Voltage vs. Junction Temperature**



**Figure 6:  $V_{GE(TH)}$  vs.  $T_j$**

**TYPICAL ELECTRICAL AND THERMAL CHARACTERISTICS**

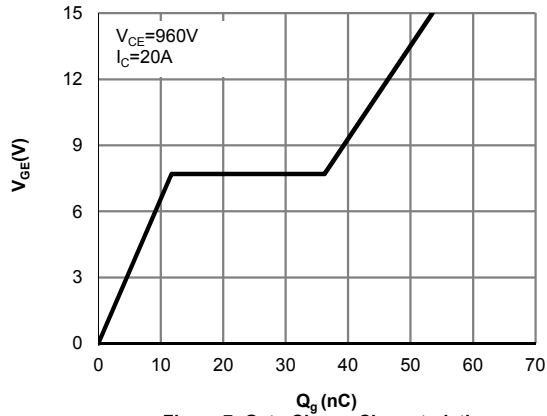


Figure 7: Gate-Charge Characteristics

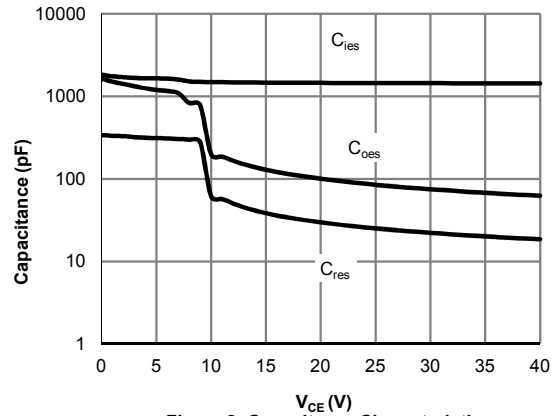


Figure 8: Capacitance Characteristic

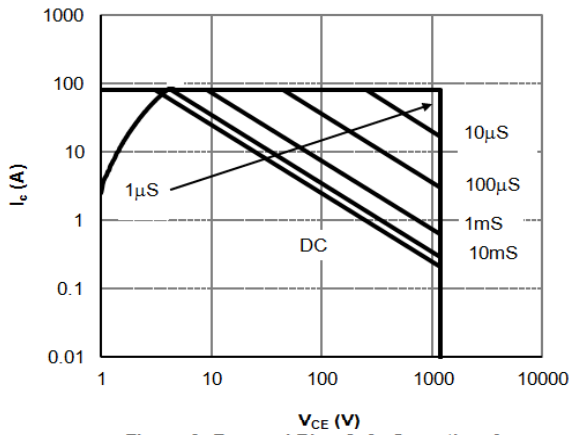


Figure 9: Forward Bias Safe Operating Area  
( $T_c=25^\circ\text{C}$ ,  $V_{GE}=15\text{V}$ )

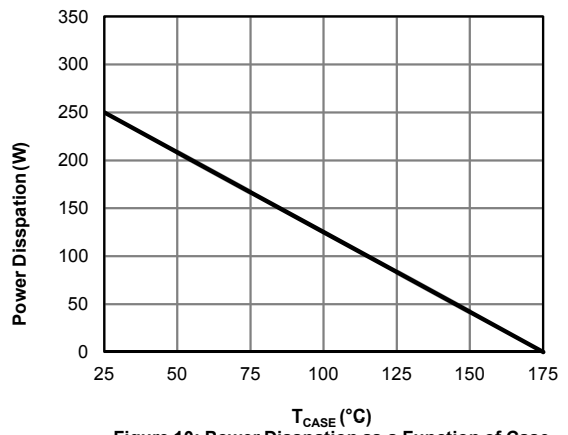


Figure 10: Power Dissipation as a Function of Case

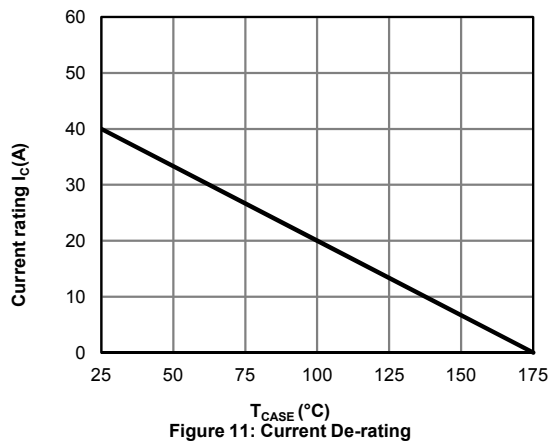
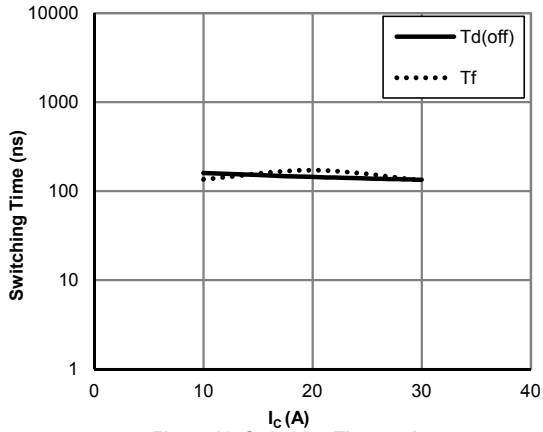
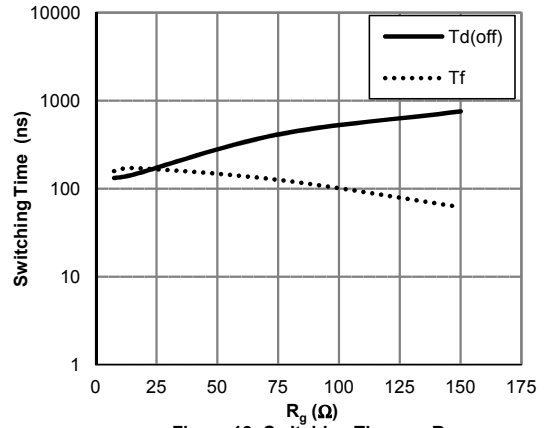


Figure 11: Current De-rating

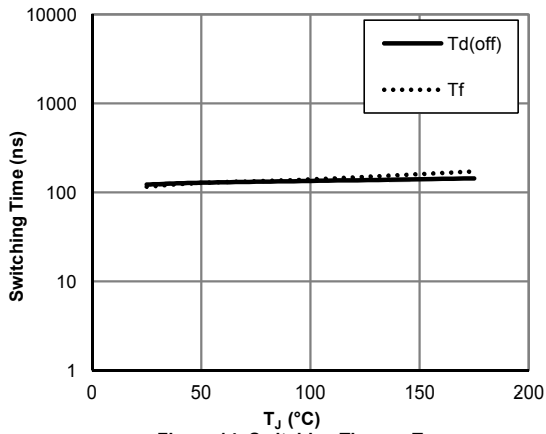
**TYPICAL ELECTRICAL AND THERMAL CHARACTERISTICS**



**Figure 12: Switching Time vs.  $I_c$**   
( $T_j=175^\circ\text{C}$ ,  $V_{GE}=15\text{V}$ ,  $V_{CE}=600\text{V}$ ,  $R_g=15\Omega$ )

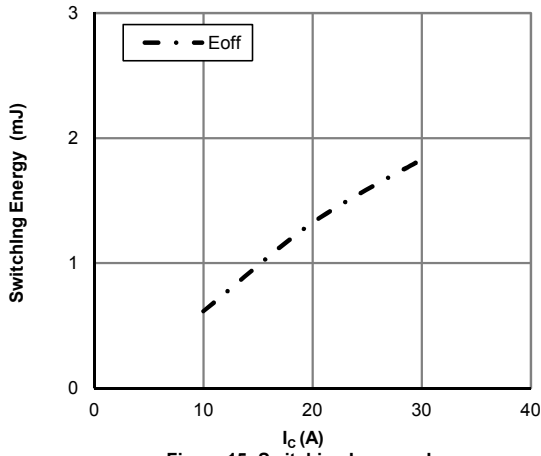


**Figure 13: Switching Time vs.  $R_g$**   
( $T_j=175^\circ\text{C}$ ,  $V_{GE}=15\text{V}$ ,  $V_{CE}=600\text{V}$ ,  $I_c=20\text{A}$ )

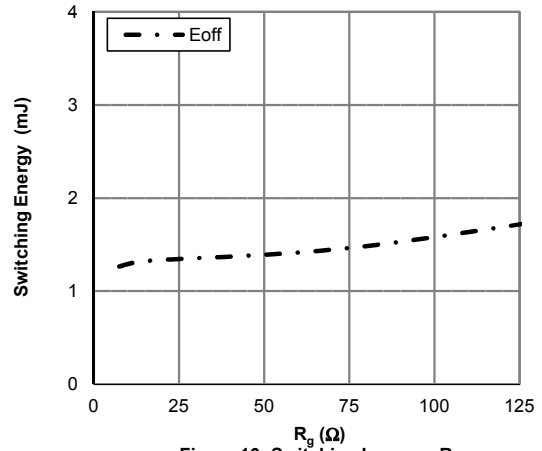


**Figure 14: Switching Time vs.  $T_j$**   
( $V_{GE}=15\text{V}$ ,  $V_{CE}=600\text{V}$ ,  $I_c=20\text{A}$ ,  $R_g=15\Omega$ )

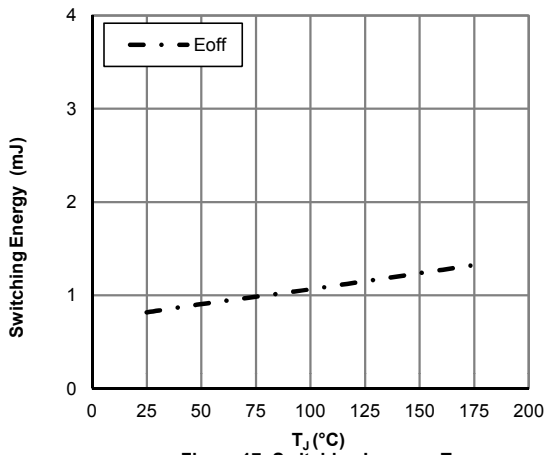
**TYPICAL ELECTRICAL AND THERMAL CHARACTERISTICS**



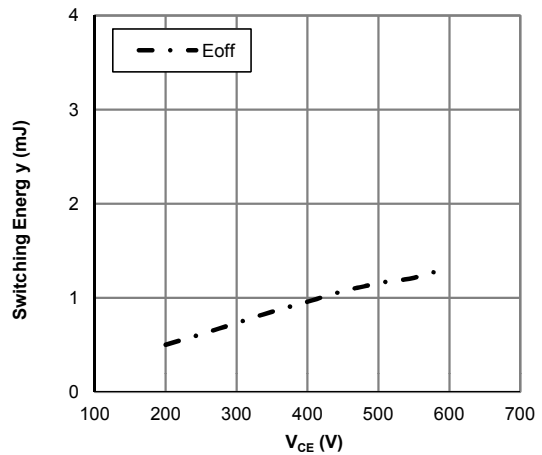
**Figure 15: Switching Loss vs.  $I_C$**   
( $T_J=175^\circ\text{C}$ ,  $V_{GE}=15\text{V}$ ,  $V_{CE}=600\text{V}$ ,  $R_g=15\Omega$ )



**Figure 16: Switching Loss vs.  $R_g$**   
( $T_J=175^\circ\text{C}$ ,  $V_{GE}=15\text{V}$ ,  $V_{CE}=600\text{V}$ ,  $I_C=20\text{A}$ )

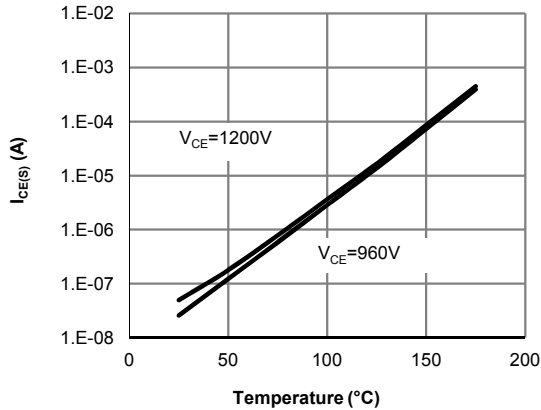


**Figure 17: Switching Loss vs.  $T_J$**   
( $V_{GE}=15\text{V}$ ,  $V_{CE}=600\text{V}$ ,  $I_C=20\text{A}$ ,  $R_g=15\Omega$ )

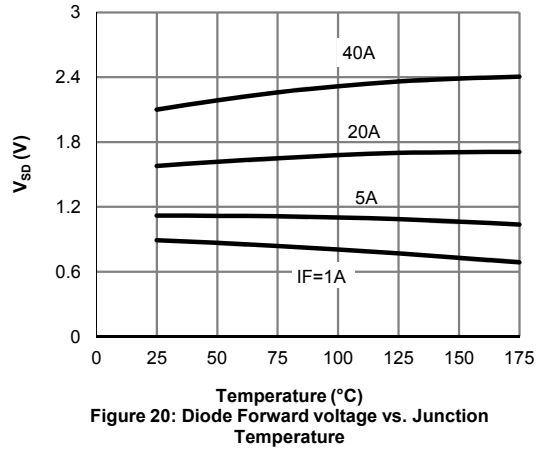


**Figure 18: Switching Loss vs.  $V_{CE}$**   
( $T_J=175^\circ\text{C}$ ,  $V_{GE}=15\text{V}$ ,  $I_C=20\text{A}$ ,  $R_g=15\Omega$ )

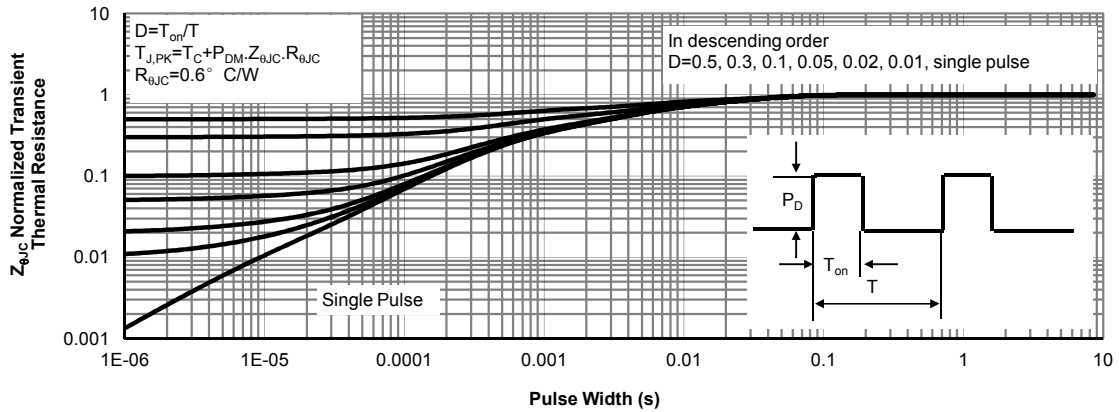
**TYPICAL ELECTRICAL AND THERMAL CHARACTERISTICS**



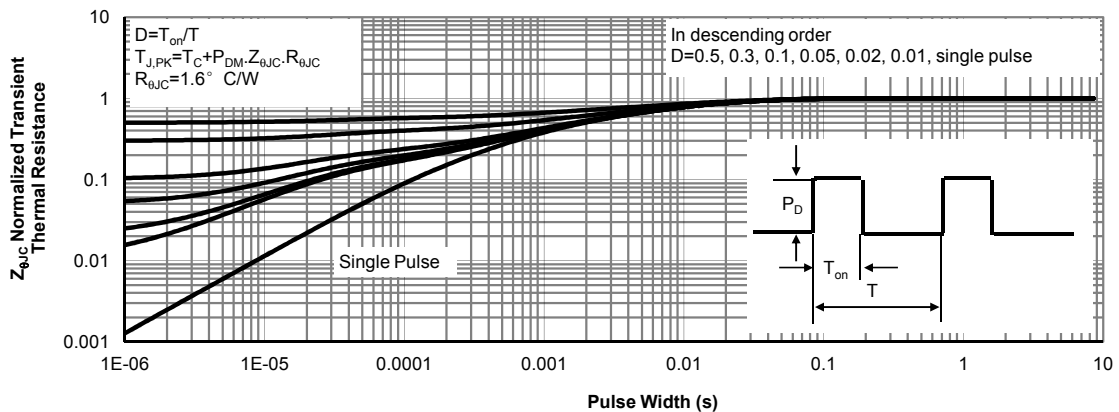
**Figure 19: Diode Reverse Leakage Current vs. Junction Temperature**



**Figure 20: Diode Forward voltage vs. Junction Temperature**



**Figure 21: Normalized Maximum Transient Thermal Impedance for IGBT**



**Figure 22: Normalized Maximum Transient Thermal Impedance for Diode**

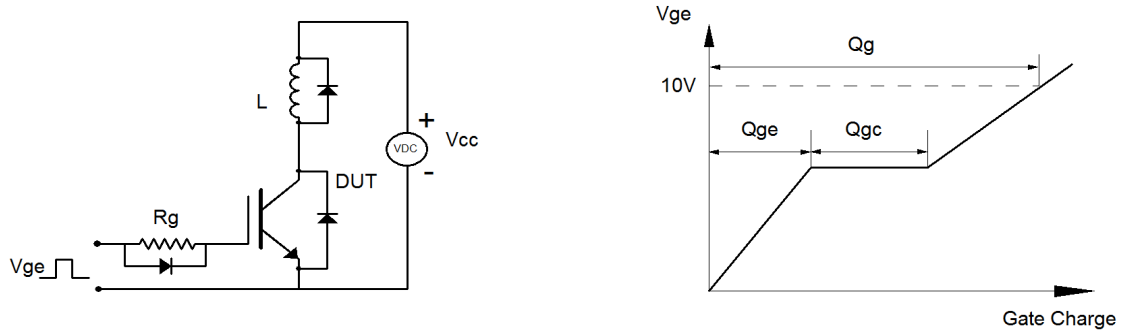


Figure A: Gate Charge Test Circuit & Waveforms

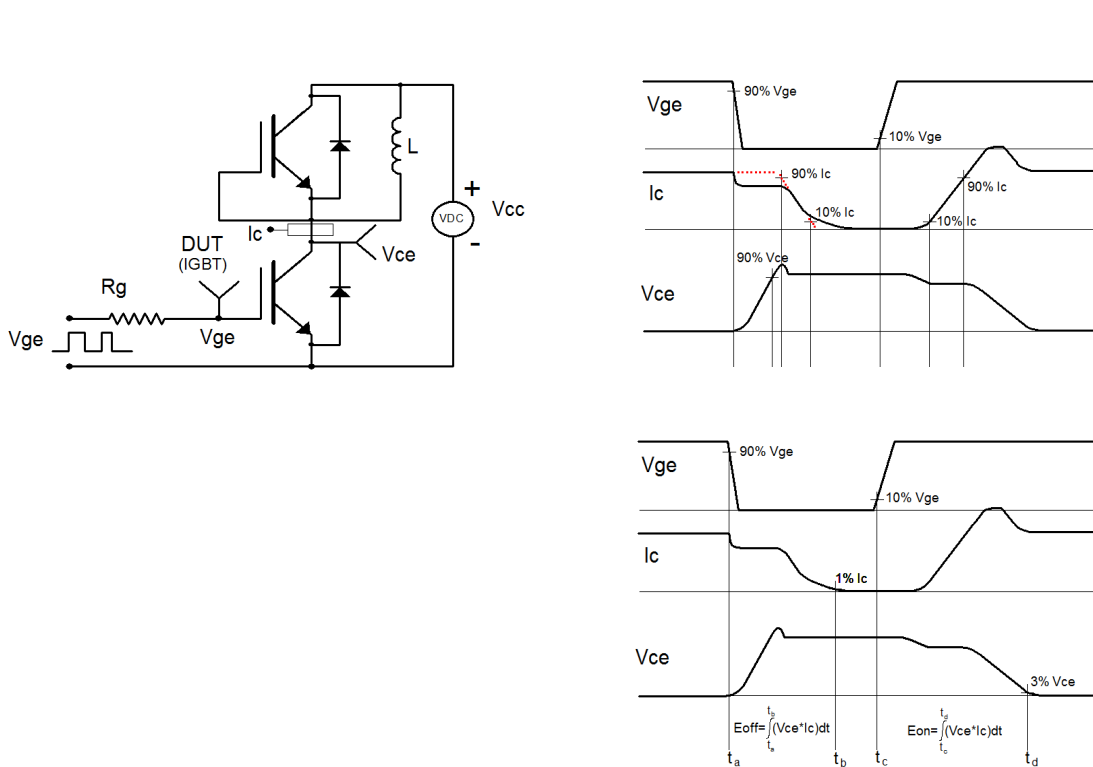


Figure B: Inductive Switching Test Circuit & Waveforms

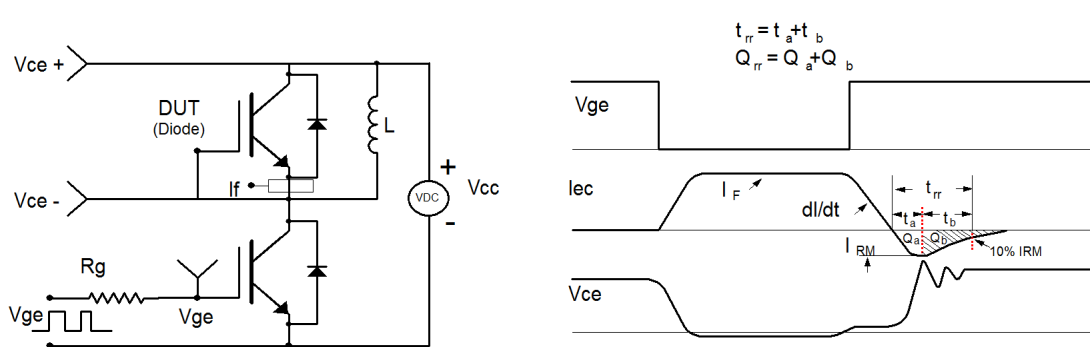


Figure C: Diode Recovery Test Circuit & Waveforms



## X-ON Electronics

Largest Supplier of Electrical and Electronic Components

*Click to view similar products for [IGBT Transistors category](#):*

*Click to view products by [Alpha & Omega manufacturer](#):*

Other Similar products are found below :

[748152A](#) [APT20GT60BRDQ1G](#) [NGTB10N60FG](#) [IGP30N60H3XKSA1](#) [STGFW20V60DF](#) [APT30GP60BG](#) [APT45GR65B2DU30](#)  
[GT50JR22\(STA1ES\)](#) [TIG058E8-TL-H](#) [VS-CPV364M4KPB](#) [NGTB25N120FL2WAG](#) [NGTG40N120FL2WG](#) [RJH60F3DPQ-A0#T0](#)  
[APT40GR120B2SCD10](#) [APT15GT120BRG](#) [APT20GT60BRG](#) [NGTB75N65FL2WAG](#) [NGTG15N120FL2WG](#) [APT70GR65B2DU40](#)  
[NTE3320](#) [FGD3440G2-F085](#) [APT70GR120J](#) [APT35GP120JDQ2](#) [IKFW40N65ES5XKSA1](#) [IMBG120R220M1HXTMA1](#)  
[IGW30N60H3FKSA1](#) [STGWA8M120DF3](#) [IGB30N60H3ATMA1](#) [IGW100N60H3FKSA1](#) [IGW75N60H3FKSA1](#) [HGTG40N60B3](#)  
[IRGS4715DPBF](#) [FGH60N60SMD\\_F085](#) [FGH75T65UPD](#) [STGWA15H120F2](#) [IKA10N60TXKSA1](#) [IHW20N120R5XKSA1](#)  
[IKW25N120T2FKSA1](#) [IHW20N65R5XKSA1](#) [IDW40E65D2FKSA1](#) [STGWT60H65FB](#) [STGWT60H65DFB](#) [STGWT40V60DF](#)  
[STGWT20V60DF](#) [STGB10NB37LZT4](#) [FGH40T70SHD-F155](#) [FGD3245G2\\_F085](#) [NGTB40N65IHL2WG](#) [HGTG30N60C3D](#)  
[HGTG30N60A4D](#)