

General Description

- Trench Power AlphaSGT™ technology
- Low $R_{DS(ON)}$
- Low Gate Charge
- Optimized for fast-switching applications

Applications

- Synchronous Rectification in DC/DC and AC/DC Converters
- Industrial and Motor Drive applications

Product Summary

V_{DS}	45V
I_D (at $V_{GS}=10V$)	100A
$R_{DS(ON)}$ (at $V_{GS}=10V$)	< 1.15m Ω
$R_{DS(ON)}$ (at $V_{GS}=4.5V$)	< 1.85m Ω

100% UIS Tested
 100% Rg Tested

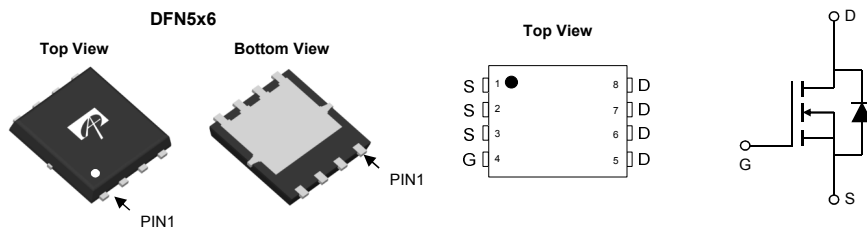

Orderable Part Number	Package Type	Form	Minimum Order Quantity
AON6152	DFN 5x6	Tape & Reel	3000

Absolute Maximum Ratings $T_A=25^\circ\text{C}$ unless otherwise noted

Parameter	Symbol	Maximum	Units
Drain-Source Voltage	V_{DS}	45	V
Gate-Source Voltage	V_{GS}	± 20	V
Continuous Drain Current ^G	I_D	$T_C=25^\circ\text{C}$	100
		$T_C=100^\circ\text{C}$	100
Pulsed Drain Current ^C	I_{DM}	400	A
Continuous Drain Current	I_{DSM}	$T_A=25^\circ\text{C}$	58
		$T_A=70^\circ\text{C}$	47
Avalanche Current ^C	I_{AS}	60	A
Avalanche energy $L=0.3\text{mH}$ ^C	E_{AS}	540	mJ
V_{DS} Spike ^I	V_{SPIKE}	54	V
Power Dissipation ^B	P_D	$T_C=25^\circ\text{C}$	208
		$T_C=100^\circ\text{C}$	83
Power Dissipation ^A	P_{DSM}	$T_A=25^\circ\text{C}$	7.3
		$T_A=70^\circ\text{C}$	4.7
Junction and Storage Temperature Range	T_J, T_{STG}	-55 to 150	$^\circ\text{C}$

Thermal Characteristics

Parameter	Symbol	Typ	Max	Units
Maximum Junction-to-Ambient ^A	$R_{\theta JA}$	14	17	$^\circ\text{C/W}$
Maximum Junction-to-Ambient ^{A,D}		Steady-State	40	50
Maximum Junction-to-Case	$R_{\theta JC}$	0.45	0.6	$^\circ\text{C/W}$

Electrical Characteristics ($T_J=25^\circ\text{C}$ unless otherwise noted)

Symbol	Parameter	Conditions	Min	Typ	Max	Units
STATIC PARAMETERS						
BV_{DSS}	Drain-Source Breakdown Voltage	$I_D=250\mu\text{A}$, $V_{GS}=0\text{V}$	45			V
I_{DSS}	Zero Gate Voltage Drain Current	$V_{DS}=45\text{V}$, $V_{GS}=0\text{V}$ $T_J=55^\circ\text{C}$			1 5	μA
I_{GSS}	Gate-Body leakage current	$V_{DS}=0\text{V}$, $V_{GS}=\pm 20\text{V}$			± 100	nA
$V_{GS(th)}$	Gate Threshold Voltage	$V_{DS}=V_{GS}$, $I_D=250\mu\text{A}$	1.3	1.8	2.3	V
$R_{DS(on)}$	Static Drain-Source On-Resistance	$V_{GS}=10\text{V}$, $I_D=20\text{A}$ $T_J=125^\circ\text{C}$		0.9	1.15	m Ω
		$V_{GS}=4.5\text{V}$, $I_D=20\text{A}$		1.5	1.9	
g_{FS}	Forward Transconductance	$V_{DS}=5\text{V}$, $I_D=20\text{A}$		100		S
V_{SD}	Diode Forward Voltage	$I_S=1\text{A}$, $V_{GS}=0\text{V}$		0.66	1	V
I_S	Maximum Body-Diode Continuous Current ^G				100	A
DYNAMIC PARAMETERS						
C_{iss}	Input Capacitance	$V_{GS}=0\text{V}$, $V_{DS}=22.5\text{V}$, $f=1\text{MHz}$	6800	8500	10200	pF
C_{oss}	Output Capacitance		780	1120	1460	pF
C_{riss}	Reverse Transfer Capacitance		25	90	155	pF
R_g	Gate resistance	$f=1\text{MHz}$	0.6	1.2	1.8	Ω
SWITCHING PARAMETERS						
$Q_g(10\text{V})$	Total Gate Charge	$V_{GS}=10\text{V}$, $V_{DS}=22.5\text{V}$, $I_D=20\text{A}$		110	155	nC
$Q_g(4.5\text{V})$	Total Gate Charge			48	70	nC
Q_{gs}	Gate Source Charge			24		nC
Q_{gd}	Gate Drain Charge			7.5		nC
$t_{D(on)}$	Turn-On Delay Time	$V_{GS}=10\text{V}$, $V_{DS}=22.5\text{V}$, $R_L=1.125\Omega$, $R_{GEN}=3\Omega$		16		ns
t_r	Turn-On Rise Time			6		ns
$t_{D(off)}$	Turn-Off Delay Time			75		ns
t_f	Turn-Off Fall Time			6.5		ns
t_{rr}	Body Diode Reverse Recovery Time	$I_F=20\text{A}$, $dI/dt=400\text{A}/\mu\text{s}$		25		ns
Q_{rr}	Body Diode Reverse Recovery Charge	$I_F=20\text{A}$, $dI/dt=400\text{A}/\mu\text{s}$		74		nC

A. The value of $R_{\theta JA}$ is measured with the device mounted on 1in² FR-4 board with 2oz. Copper, in a still air environment with $T_A=25^\circ\text{C}$. The Power dissipation P_{DSM} is based on $R_{\theta JA} \leq 10\text{s}$ and the maximum allowed junction temperature of 150°C . The value in any given application depends on the user's specific board design.

B. The power dissipation P_D is based on $T_{J(MAX)}=150^\circ\text{C}$, using junction-to-case thermal resistance, and is more useful in setting the upper dissipation limit for cases where additional heatsinking is used.

C. Single pulse width limited by junction temperature $T_{J(MAX)}=150^\circ\text{C}$.

D. The $R_{\theta JA}$ is the sum of the thermal impedance from junction to case $R_{\theta JC}$ and case to ambient.

E. The static characteristics in Figures 1 to 6 are obtained using $<300\mu\text{s}$ pulses, duty cycle 0.5% max.

F. These curves are based on the junction-to-case thermal impedance which is measured with the device mounted to a large heatsink, assuming a maximum junction temperature of $T_{J(MAX)}=150^\circ\text{C}$. The SOA curve provides a single pulse rating.

G. The maximum current rating is package limited.

H. These tests are performed with the device mounted on 1 in² FR-4 board with 2oz. Copper, in a still air environment with $T_A=25^\circ\text{C}$.

I. The spike duty cycle 5% max in every frequency period, limited by junction temperature $T_{J(MAX)}=125^\circ\text{C}$.

THIS PRODUCT HAS BEEN DESIGNED AND QUALIFIED FOR THE CONSUMER MARKET. APPLICATIONS OR USES AS CRITICAL COMPONENTS IN LIFE SUPPORT DEVICES OR SYSTEMS ARE NOT AUTHORIZED. AOS DOES NOT ASSUME ANY LIABILITY ARISING OUT OF SUCH APPLICATIONS OR USES OF ITS PRODUCTS. AOS RESERVES THE RIGHT TO IMPROVE PRODUCT DESIGN, FUNCTIONS AND RELIABILITY WITHOUT NOTICE.

TYPICAL ELECTRICAL AND THERMAL CHARACTERISTICS

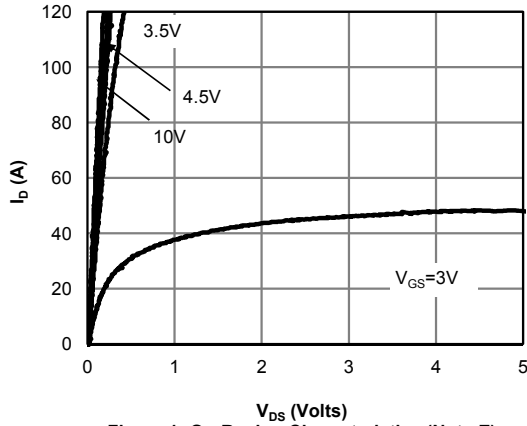

Figure 1: On-Region Characteristics (Note E)

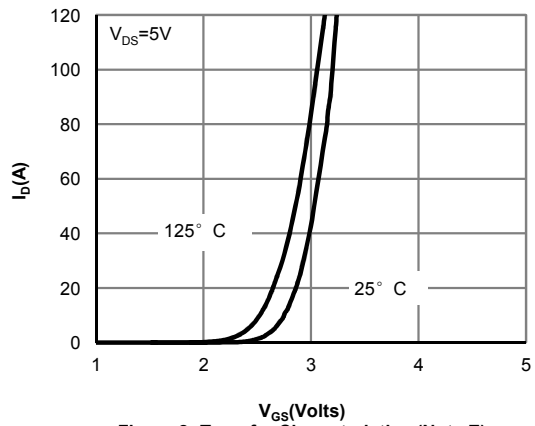

Figure 2: Transfer Characteristics (Note E)

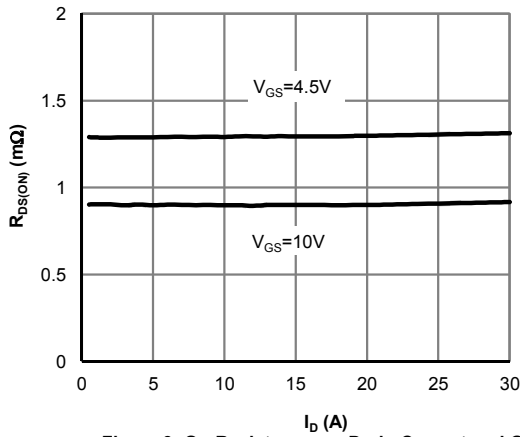

Figure 3: On-Resistance vs. Drain Current and Gate Voltage (Note E)

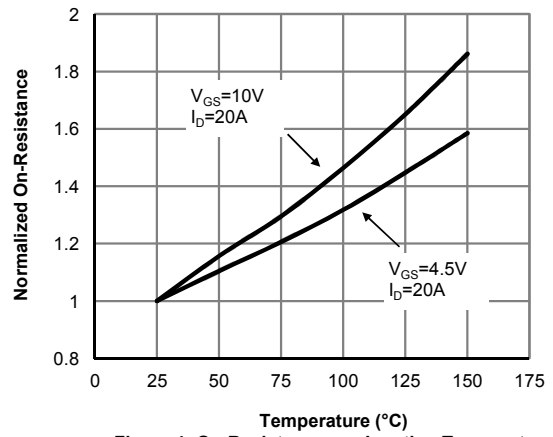

Figure 4: On-Resistance vs. Junction Temperature (Note E)

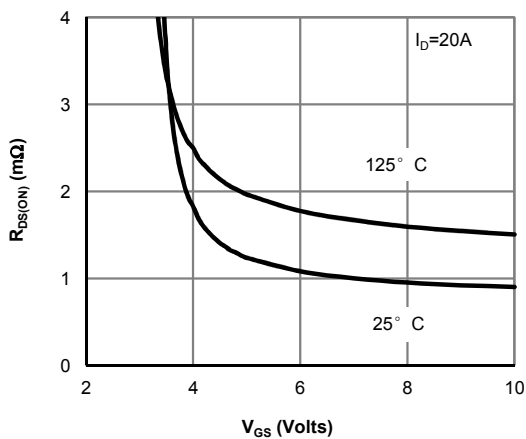

Figure 5: On-Resistance vs. Gate-Source Voltage (Note E)

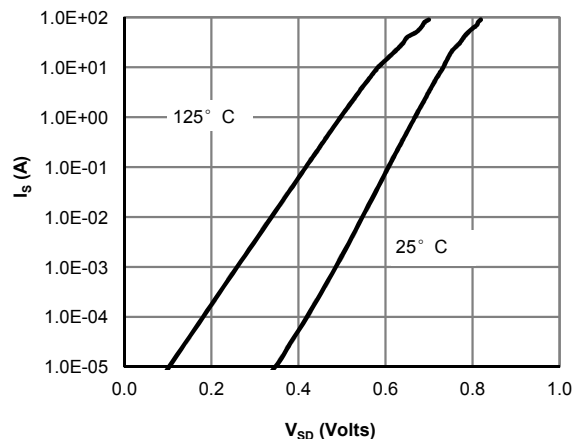

Figure 6: Body-Diode Characteristics (Note E)

TYPICAL ELECTRICAL AND THERMAL CHARACTERISTICS

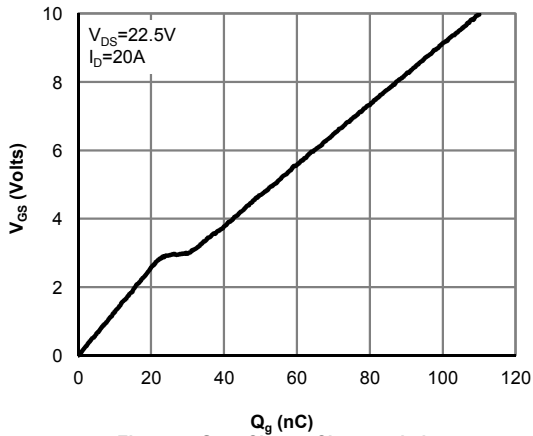

Figure 7: Gate-Charge Characteristics

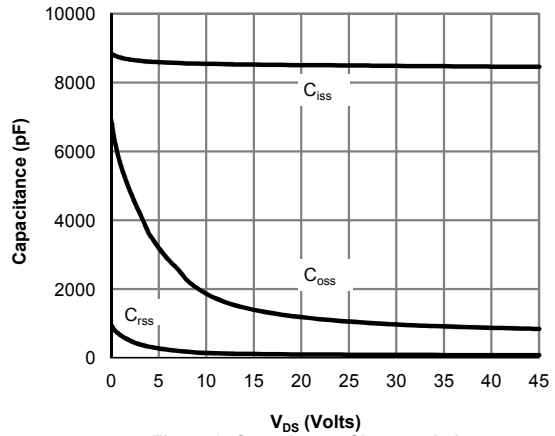

Figure 8: Capacitance Characteristics

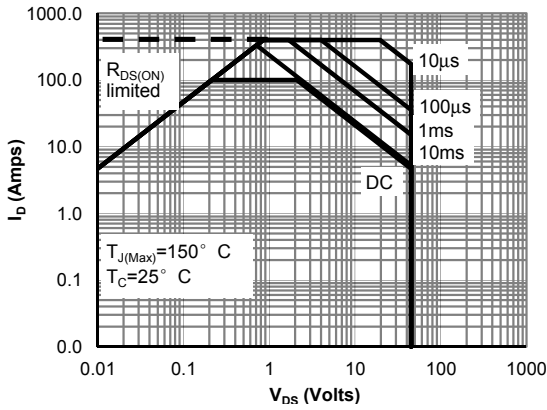

Figure 9: Maximum Forward Biased Safe Operating Area (Note F)

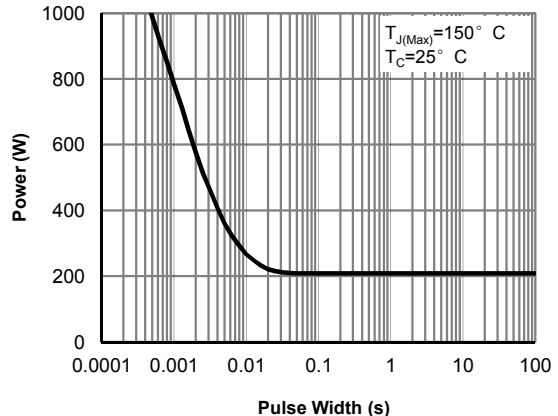

Figure 10: Single Pulse Power Rating Junction-to-Case (Note F)

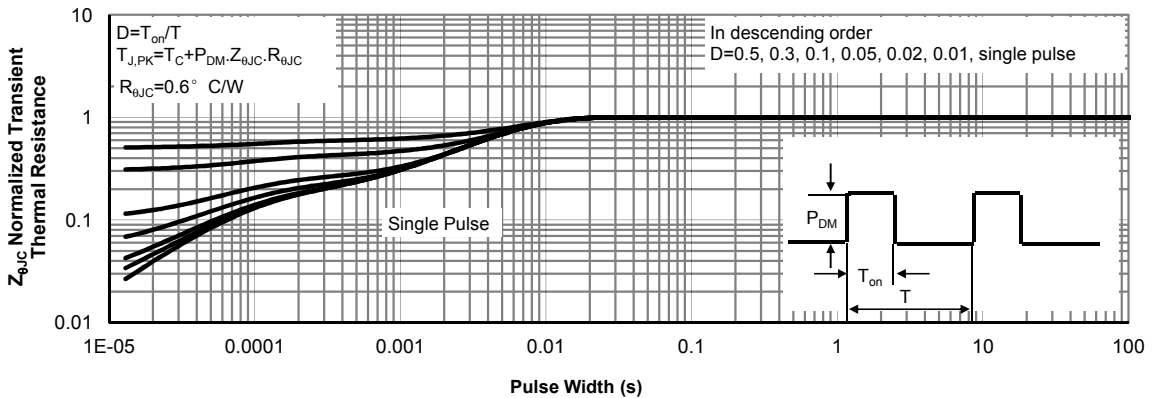

Figure 11: Normalized Maximum Transient Thermal Impedance (Note F)

TYPICAL ELECTRICAL AND THERMAL CHARACTERISTICS

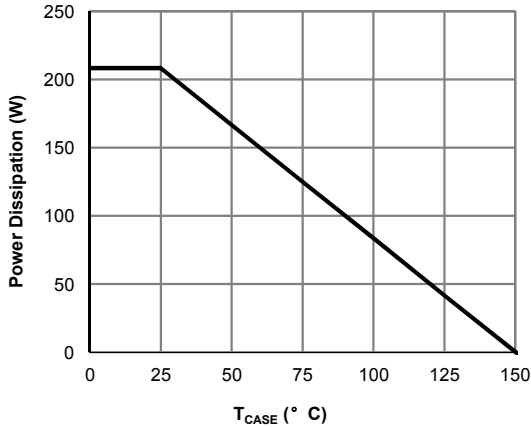

Figure 12: Power De-rating (Note F)

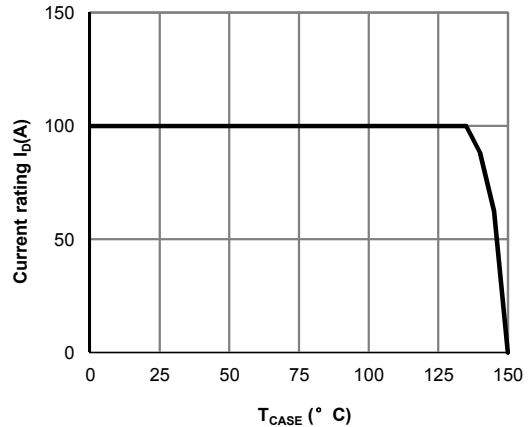

Figure 13: Current De-rating (Note F)

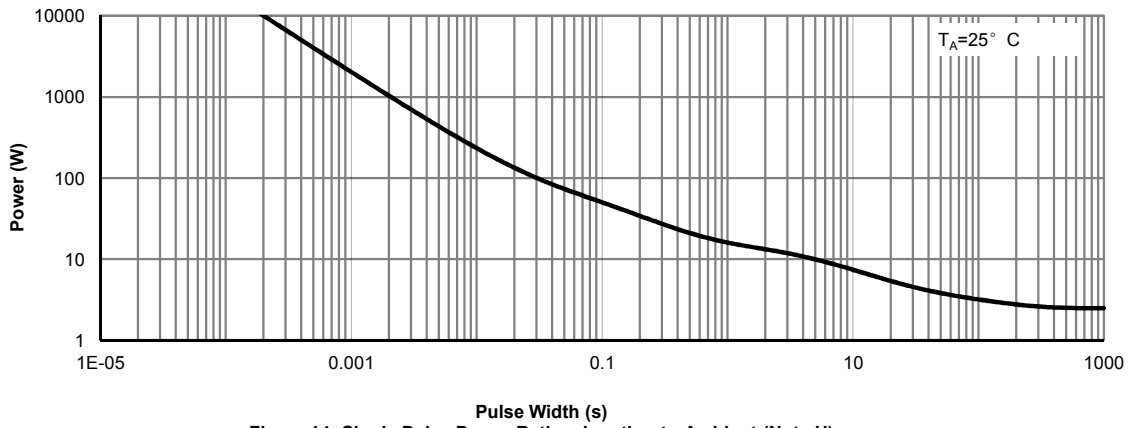

Figure 14: Single Pulse Power Rating Junction-to-Ambient (Note H)

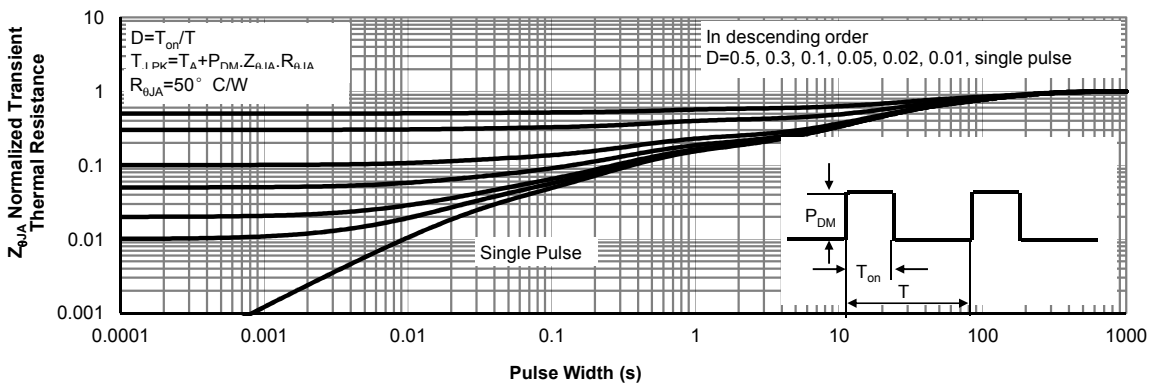
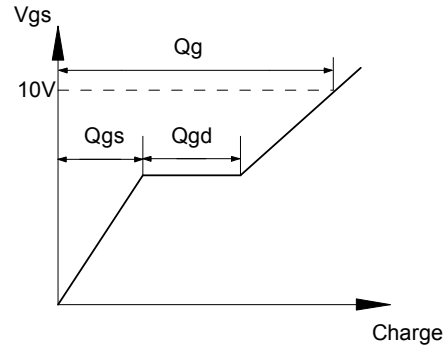
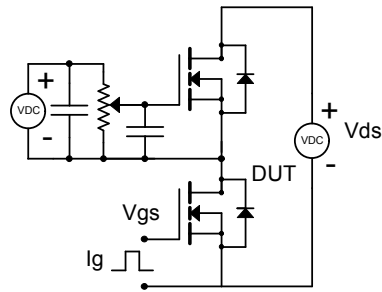
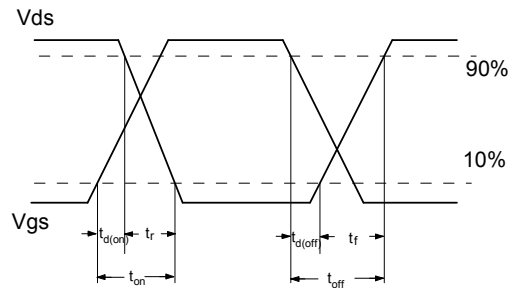
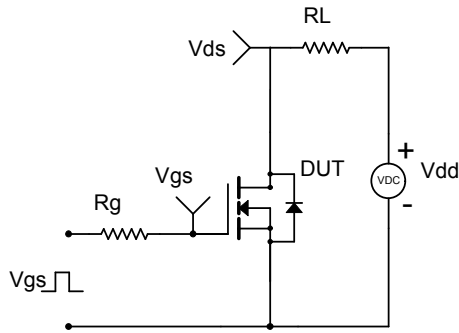

Figure 15: Normalized Maximum Transient Thermal Impedance (Note H)

Gate Charge Test Circuit & Waveform



Resistive Switching Test Circuit & Waveforms



Unclamped Inductive Switching (UIS) Test Circuit & Waveforms

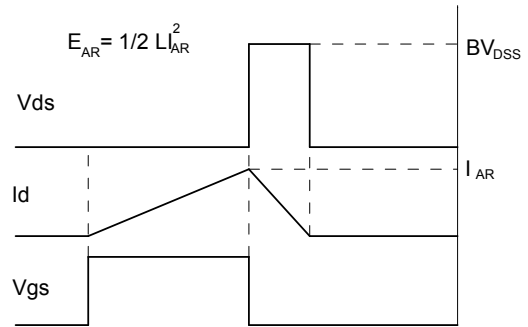
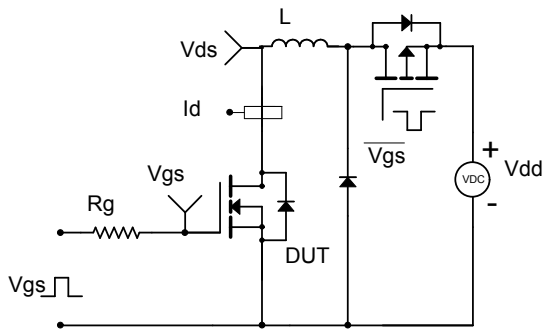

Diode Recovery Test Circuit & Waveforms

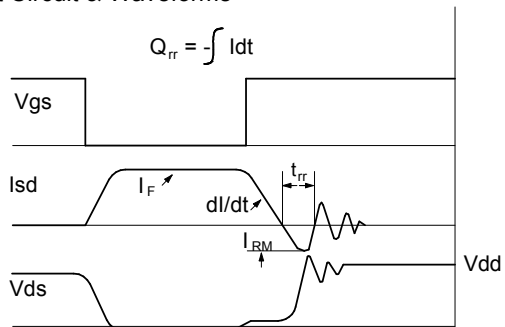
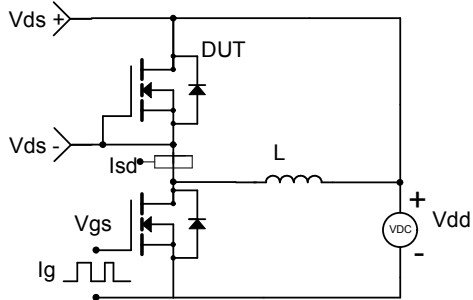

X-ON Electronics

Largest Supplier of Electrical and Electronic Components

Click to view similar products for [MOSFET](#) category:

Click to view products by [Alpha & Omega](#) manufacturer:

Other Similar products are found below :

[614233C](#) [648584F](#) [IRFD120](#) [JANTX2N5237](#) [2N7000](#) [FCA20N60_F109](#) [FDZ595PZ](#) [2SK2545\(Q,T\)](#) [405094E](#) [423220D](#)
[TPCC8103,L1Q\(CM](#) [MIC4420CM-TR](#) [VN1206L](#) [614234A](#) [715780A](#) [NTNS3166NZT5G](#) [SSM6J414TU,LF\(T](#) [751625C](#) [IPP110N20N3GXX](#)
[IPS70R2K0CEAKMA1](#) [DMN3404LQ-7](#) [NTE6400](#) [2SK2614\(TE16L1,Q\)](#) [DMN1017UCP3-7](#) [EFC2J004NUZTDG](#) [ECH8691-TL-W](#)
[FCAB21350L1](#) [P85W28HP2F-7071](#) [DMN1053UCP4-7](#) [NTE221](#) [NTE2384](#) [NTE2903](#) [NTE2941](#) [NTE2945](#) [NTE2946](#) [NTE2960](#) [NTE2969](#)
[NTE2976](#) [NTE455](#) [NTE6400A](#) [NTE2910](#) [NTE2916](#) [NTE2956](#) [NTE2911](#) [TK10A80W,S4X\(S](#) [SSM6P69NU,LF](#) [DMP22D4UFO-7B](#)
[DMN1006UCA6-7](#) [DMN16M9UCA6-7](#) [STF5N65M6](#)