

General Description

- Trench Power AlphaSGT™ technology
- Low $R_{DS(ON)}$
- Logic Driven
- RoHS and Halogen-Free Compliant

Applications

- Synchronous Rectification for Quick Charger 3.0
- Synchronous Rectification for AC/DC adapter and DC/DC brick power

Product Summary

V_{DS}	80V
I_D (at $V_{GS}=10V$)	48A
$R_{DS(ON)}$ (at $V_{GS}=10V$)	< 6.5m Ω
$R_{DS(ON)}$ (at $V_{GS}=4.5V$)	< 8.5m Ω

100% UIS Tested
 100% Rg Tested

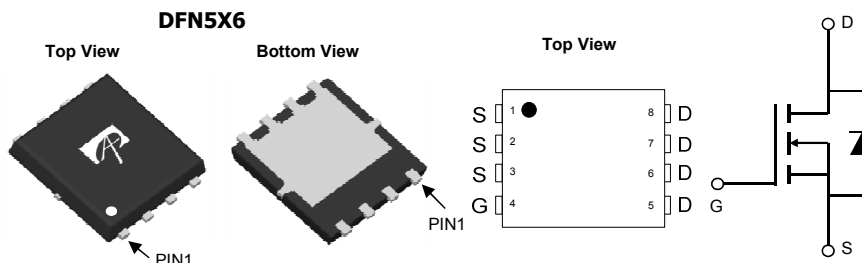

Orderable Part Number	Package Type	Form	Minimum Order Quantity
AON6284A	DFN 5x6	Tape & Reel	3000

Absolute Maximum Ratings $T_A=25^\circ C$ unless otherwise noted

Parameter	Symbol	Maximum	Units
Drain-Source Voltage	V_{DS}	80	V
Gate-Source Voltage	V_{GS}	± 20	V
Continuous Drain Current ^G	$T_C=25^\circ C$	48	A
	$T_C=100^\circ C$	42.5	
Pulsed Drain Current ^C	I_{DM}	170	
Continuous Drain Current	$T_A=25^\circ C$	20	A
	$T_A=70^\circ C$	16	
Avalanche Current ^C	I_{AS}	40	A
Avalanche energy $L=0.1mH$ ^C	E_{AS}	80	mJ
V_{DS} Spike	V_{SPIKE}	96	V
Power Dissipation ^B	$T_C=25^\circ C$	56	W
	$T_C=100^\circ C$	22	
Power Dissipation ^A	$T_A=25^\circ C$	5.0	W
	$T_A=70^\circ C$	3.2	
Junction and Storage Temperature Range	T_J, T_{STG}	-55 to 150	$^\circ C$

Thermal Characteristics

Parameter	Symbol	Typ	Max	Units
Maximum Junction-to-Ambient ^A $t \leq 10s$	$R_{\theta JA}$	20	25	$^\circ C/W$
Maximum Junction-to-Ambient ^{A,D} Steady-State		45	55	$^\circ C/W$
Maximum Junction-to-Case Steady-State	$R_{\theta JC}$	1.8	2.2	$^\circ C/W$

Electrical Characteristics (T_J=25°C unless otherwise noted)

Symbol	Parameter	Conditions	Min	Typ	Max	Units
STATIC PARAMETERS						
BV _{DSS}	Drain-Source Breakdown Voltage	I _D =250μA, V _{GS} =0V	80			V
I _{DSS}	Zero Gate Voltage Drain Current	V _{DS} =80V, V _{GS} =0V T _J =55°C			1 5	μA
I _{GSS}	Gate-Body leakage current	V _{DS} =0V, V _{GS} =±20V			±100	nA
V _{GS(th)}	Gate Threshold Voltage	V _{DS} =V _{GS} , I _D =250μA	1.3	1.7	2.3	V
R _{DS(on)}	Static Drain-Source On-Resistance	V _{GS} =10V, I _D =20A T _J =125°C		5.2	6.5	mΩ
		V _{GS} =4.5V, I _D =20A		8.8	11	
g _{FS}	Forward Transconductance	V _{DS} =5V, I _D =20A		77		S
V _{SD}	Diode Forward Voltage	I _S =1A, V _{GS} =0V		0.68	1	V
I _S	Maximum Body-Diode Continuous Current ^G				48	A
DYNAMIC PARAMETERS						
C _{iss}	Input Capacitance	V _{GS} =0V, V _{DS} =40V, f=1MHz		2540		pF
C _{oss}	Output Capacitance			310		pF
C _{rss}	Reverse Transfer Capacitance			18.5		pF
R _g	Gate resistance	f=1MHz	0.7	1.45	2.2	Ω
SWITCHING PARAMETERS						
Q _{g(10V)}	Total Gate Charge	V _{GS} =10V, V _{DS} =40V, I _D =20A		36	52	nC
Q _{g(4.5V)}	Total Gate Charge			16.5	25	nC
Q _{gs}	Gate Source Charge			6.5		nC
Q _{gd}	Gate Drain Charge			6		nC
t _{D(on)}	Turn-On DelayTime	V _{GS} =10V, V _{DS} =40V, R _L =2Ω, R _{GEN} =3Ω		7.5		ns
t _r	Turn-On Rise Time			4		ns
t _{D(off)}	Turn-Off DelayTime			32		ns
t _f	Turn-Off Fall Time			6		ns
t _{rr}	Body Diode Reverse Recovery Time	I _F =20A, di/dt=500A/μs		23		ns
Q _{rr}	Body Diode Reverse Recovery Charge	I _F =20A, di/dt=500A/μs		91		nC

A. The value of R_{θJA} is measured with the device mounted on 1in² FR-4 board with 2oz. Copper, in a still air environment with T_A=25° C. The Power dissipation P_{DSM} is based on R_{θJA} ≤ 10s and the maximum allowed junction temperature of 150° C. The value in any given application depends on the user's specific board design.

B. The power dissipation P_D is based on T_{J(MAX)}=150° C, using junction-to-case thermal resistance, and is more useful in setting the upper dissipation limit for cases where additional heatsinking is used.

C. Single pulse width limited by junction temperature T_{J(MAX)}=150° C.

D. The R_{θJA} is the sum of the thermal impedance from junction to case R_{θJC} and case to ambient.

E. The static characteristics in Figures 1 to 6 are obtained using <300μs pulses, duty cycle 0.5% max.

F. These curves are based on the junction-to-case thermal impedance which is measured with the device mounted to a large heatsink, assuming a maximum junction temperature of T_{J(MAX)}=150° C. The SOA curve provides a single pulse rating.

G. The maximum current rating is package limited.

H. These tests are performed with the device mounted on 1 in² FR-4 board with 2oz. Copper, in a still air environment with T_A=25° C.

APPLICATIONS OR USE AS CRITICAL COMPONENTS IN LIFE SUPPORT DEVICES OR SYSTEMS ARE NOT AUTHORIZED. AOS DOES NOT ASSUME ANY LIABILITY ARISING OUT OF SUCH APPLICATIONS OR USES OF ITS PRODUCTS. AOS RESERVES THE RIGHT TO IMPROVE PRODUCT DESIGN,FUNCTIONS AND RELIABILITY WITHOUT NOTICE.

TYPICAL ELECTRICAL AND THERMAL CHARACTERISTICS

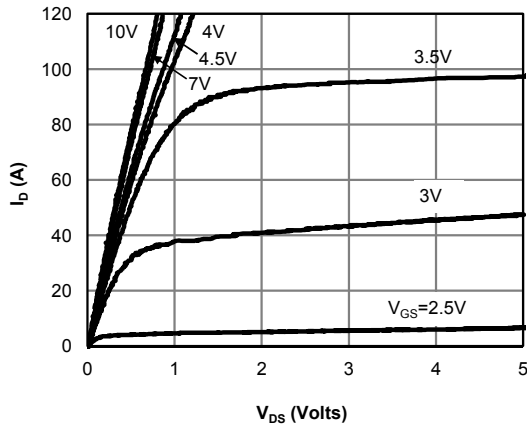

Figure 1: On-Region Characteristics (Note E)

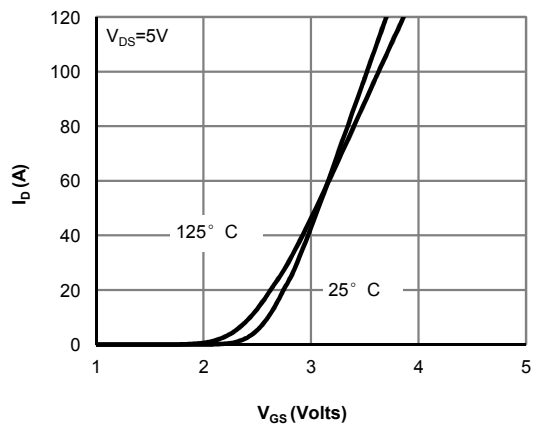

Figure 2: Transfer Characteristics (Note E)

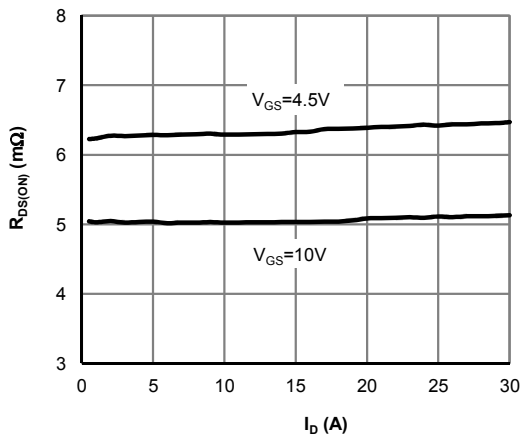

Figure 3: On-Resistance vs. Drain Current and Gate Voltage (Note E)

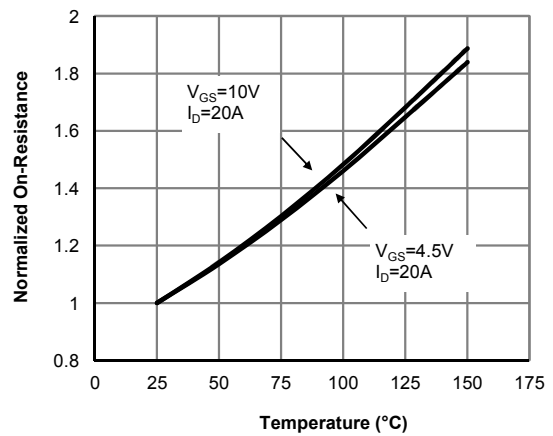

Figure 4: On-Resistance vs. Junction Temperature (Note E)

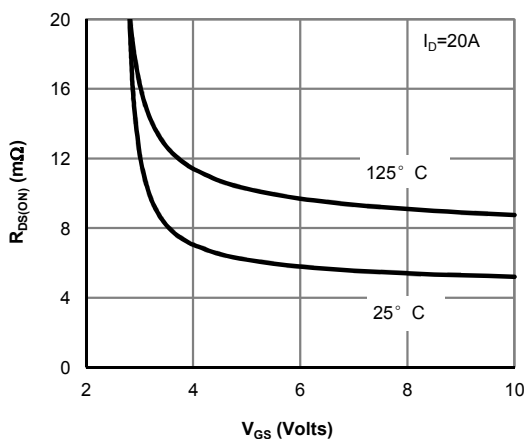

Figure 5: On-Resistance vs. Gate-Source Voltage (Note E)

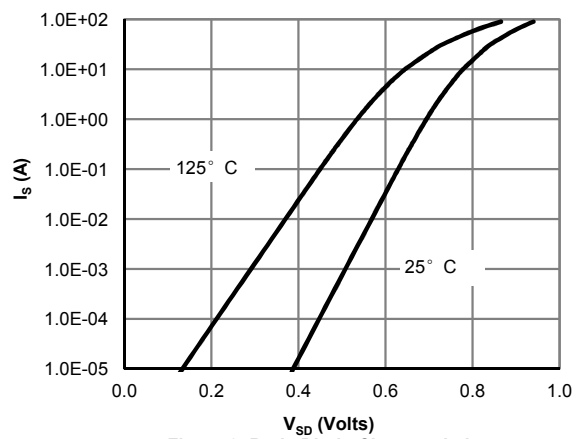

Figure 6: Body-Diode Characteristics (Note E)

TYPICAL ELECTRICAL AND THERMAL CHARACTERISTICS

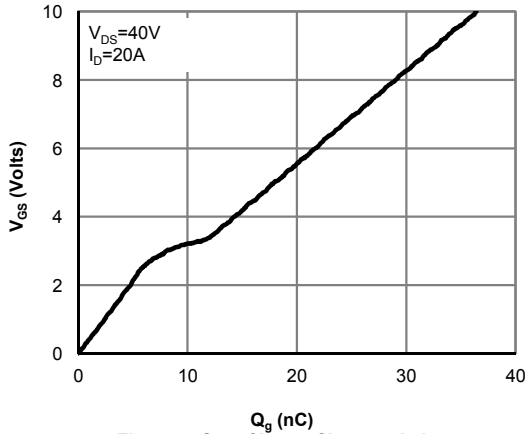

Figure 7: Gate-Charge Characteristics

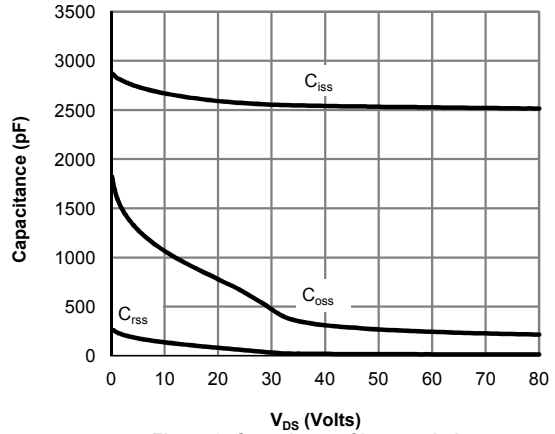

Figure 8: Capacitance Characteristics

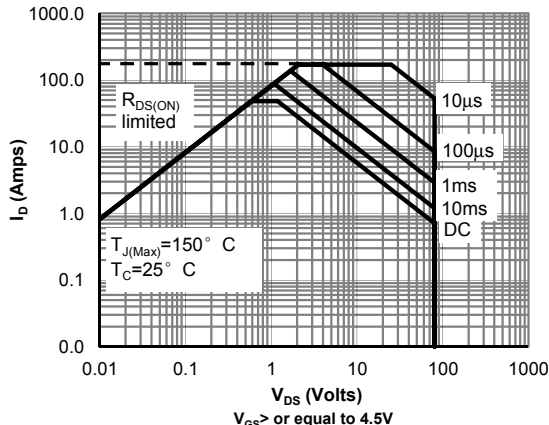

Figure 9: Maximum Forward Biased Safe Operating Area (Note F)

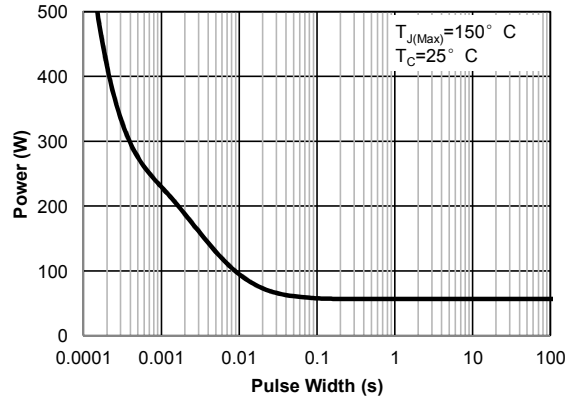

Figure 10: Single Pulse Power Rating Junction-to-Case (Note F)

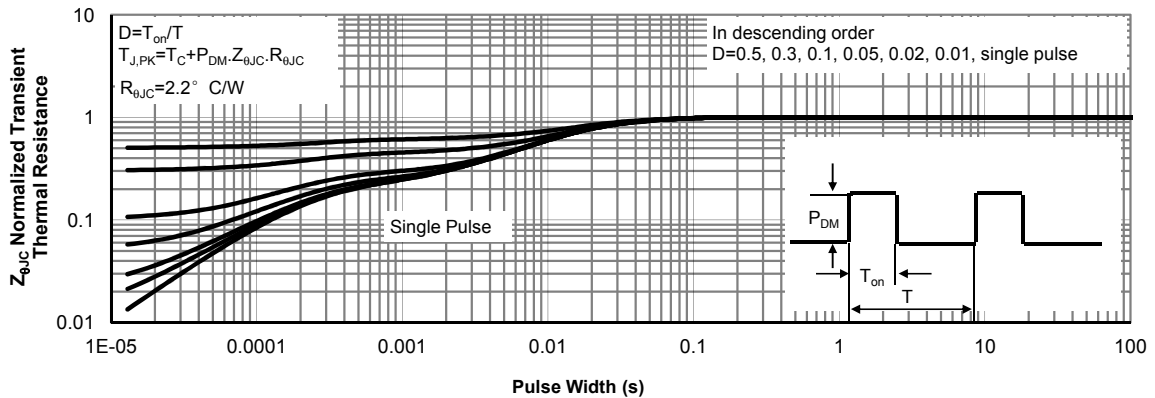

Figure 11: Normalized Maximum Transient Thermal Impedance (Note F)

TYPICAL ELECTRICAL AND THERMAL CHARACTERISTICS

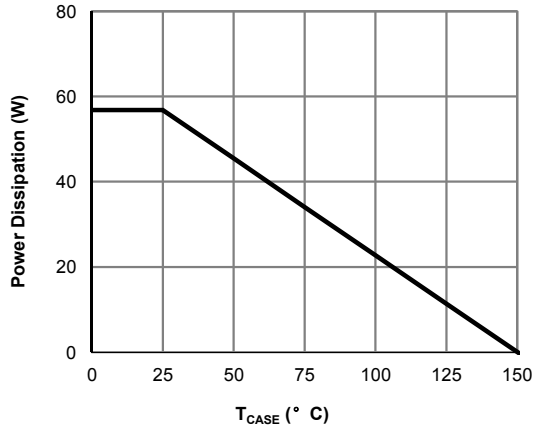

Figure 12: Power De-rating (Note F)

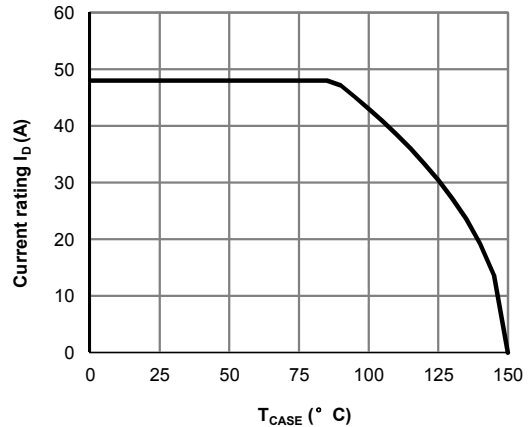

Figure 13: Current De-rating (Note F)

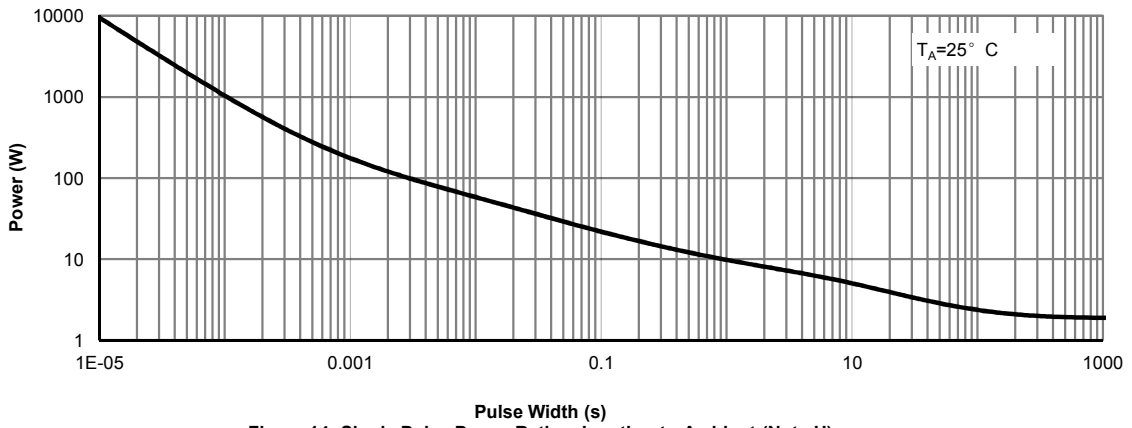

Figure 14: Single Pulse Power Rating Junction-to-Ambient (Note H)

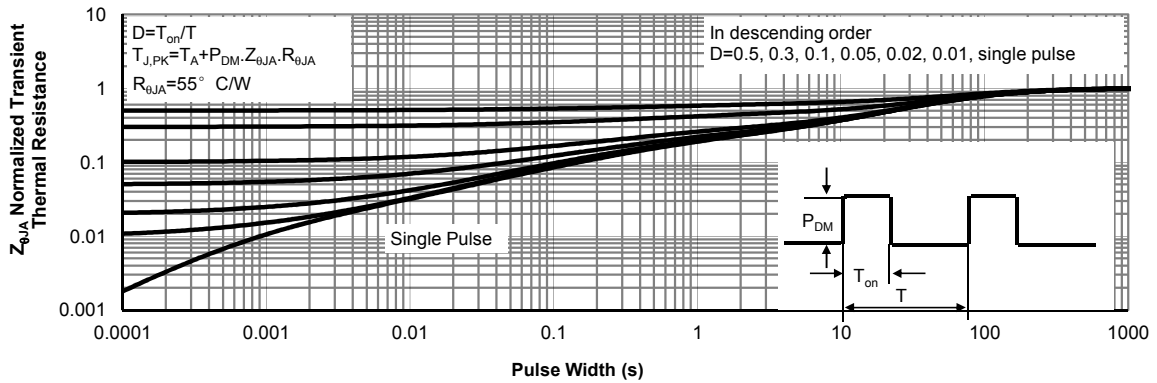

Figure 15: Normalized Maximum Transient Thermal Impedance (Note H)

Figure A: Gate Charge Test Circuit & Waveforms



Figure B: Resistive Switching Test Circuit & Waveforms



Figure C: Unclamped Inductive Switching (UIS) Test Circuit & Waveforms



Figure D: Diode Recovery Test Circuit & Waveforms

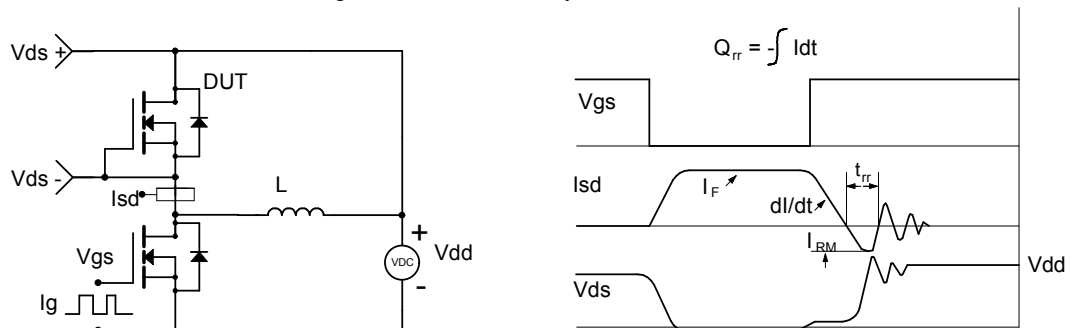

X-ON Electronics

Largest Supplier of Electrical and Electronic Components

Click to view similar products for [MOSFET](#) category:

Click to view products by [Alpha & Omega](#) manufacturer:

Other Similar products are found below :

[614233C](#) [648584F](#) [FDPF9N50NZ](#) [IRFD120](#) [JANTX2N5237](#) [2N7000](#) [FCA20N60_F109](#) [FDZ595PZ](#) [2SK2545\(Q,T\)](#) [405094E](#) [423220D](#)
[TPCC8103,L1Q\(CM](#) [MIC4420CM-TR](#) [VN1206L](#) [614234A](#) [715780A](#) [NTNS3166NZT5G](#) [SSM6J414TU,LF\(T](#) [751625C](#) [IPP110N20N3GXX](#)
[IPS70R2K0CEAKMA1](#) [DMN3404LQ-7](#) [NTE6400](#) [2SK2614\(TE16L1,Q\)](#) [DMN1017UCP3-7](#) [EFC2J004NUZTDG](#) [ECH8691-TL-W](#)
[FCAB21350L1](#) [P85W28HP2F-7071](#) [DMN1053UCP4-7](#) [NTE221](#) [NTE2384](#) [NTE2903](#) [NTE2941](#) [NTE2945](#) [NTE2946](#) [NTE2960](#) [NTE2969](#)
[NTE2976](#) [NTE455](#) [NTE6400A](#) [NTE2910](#) [NTE2916](#) [NTE2956](#) [NTE2911](#) [TK10A80W,S4X\(S](#) [SSM6P69NU,LF](#) [DMP22D4UFO-7B](#)
[DMN1006UCA6-7](#) [DMN16M9UCA6-7](#)