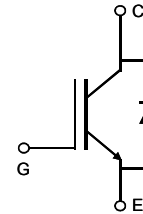
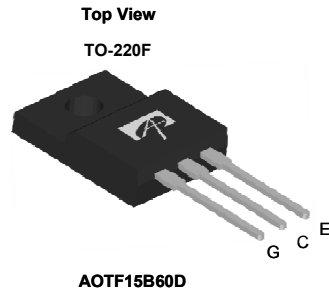


### General Description

The Alpha IGBT™ line of products offers best-in-class performance in conduction and switching losses, with robust short circuit capability. They are designed for ease of paralleling, minimal gate spike under high dV/dt conditions and resistance to oscillations. The soft co-package diode is targeted for minimal losses in motor control applications.

### Product Summary

$V_{CE}$	600V
$I_C$ ( $T_C=100^\circ\text{C}$ )	15A
$V_{CE(sat)}$ ( $T_C=25^\circ\text{C}$ )	1.6V



### Absolute Maximum Ratings $T_A=25^\circ\text{C}$ unless otherwise noted

Parameter	Symbol	AOTF15B60D	Units
Collector-Emitter Voltage	$V_{CE}$	600	V
Gate-Emitter Voltage	$V_{GE}$	$\pm 20$	V
Continuous Collector Current	$I_C$	$T_C=25^\circ\text{C}$	$30^S$
		$T_C=100^\circ\text{C}$	$15^S$
Pulsed Collector Current, Limited by $T_{Jmax}$	$I_{CM}$	60	A
Turn off SOA, $V_{CE} \leq 600\text{V}$ , Limited by $T_{Jmax}$	$I_{LM}$	60	A
Continuous Diode Forward Current	$I_F$	$T_C=25^\circ\text{C}$	30
		$T_C=100^\circ\text{C}$	15
Diode Pulsed Current, Limited by $T_{Jmax}$	$I_{FM}$	60	A
Short circuit withstanding time $V_{GE} = 15\text{V}$ , $V_{CE} \leq 400\text{V}$ , Delay between short circuits $\geq 1.0\text{s}$ , $T_C=25^\circ\text{C}$	$t_{SC}$	10	$\mu\text{s}$
Power Dissipation	$P_D$	$T_C=25^\circ\text{C}$	50
		$T_C=100^\circ\text{C}$	25
Junction and Storage Temperature Range	$T_J, T_{STG}$	-55 to 150	$^\circ\text{C}$
Maximum lead temperature for soldering purpose, 1/8" from case for 5 seconds	$T_L$	300	$^\circ\text{C}$

### Thermal Characteristics

Parameter	Symbol	AOTF15B60D	Units
Maximum Junction-to-Ambient	$R_{\theta JA}$	65	$^\circ\text{C}/\text{W}$
Maximum IGBT Junction-to-Case	$R_{\theta JC}$	3	$^\circ\text{C}/\text{W}$
Maximum Diode Junction-to-Case	$R_{\theta JC}$	4	$^\circ\text{C}/\text{W}$

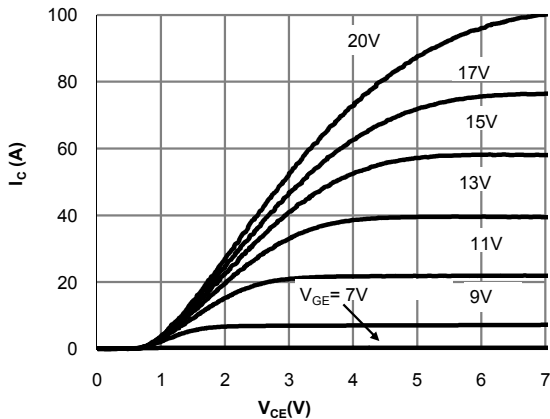
‡:TO220F  $I_C$  Follow TO220

**Electrical Characteristics (T<sub>J</sub>=25°C unless otherwise noted)**

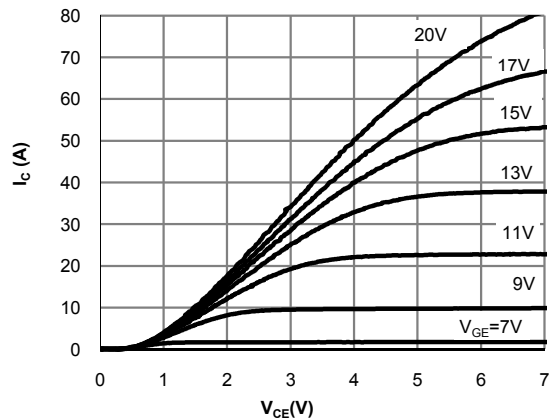
Symbol	Parameter	Conditions	Min	Typ	Max	Units	
<b>STATIC PARAMETERS</b>							
$BV_{CES}$	Collector-Emitter Breakdown Voltage	$I_C=250\mu A, V_{GE}=0V, T_J=25^\circ C$	600	-	-	V	
$V_{CE(sat)}$	Collector-Emitter Saturation Voltage	$V_{GE}=15V, I_C=15A$	$T_J=25^\circ C$	-	1.6	1.8	V
			$T_J=125^\circ C$	-	1.85	-	
			$T_J=150^\circ C$	-	1.92	-	
$V_F$	Diode Forward Voltage	$V_{GE}=0V, I_C=15A$	$T_J=25^\circ C$	-	1.43	1.72	V
			$T_J=125^\circ C$	-	1.39	-	
			$T_J=150^\circ C$	-	1.36	-	
$V_{GE(th)}$	Gate-Emitter Threshold Voltage	$V_{CE}=V_{GE}, I_C=250\mu A$	-	5.6	-	V	
$I_{CES}$	Zero Gate Voltage Collector Current	$V_{CE}=600V, V_{GE}=0V$	$T_J=25^\circ C$	-	-	10	$\mu A$
			$T_J=125^\circ C$	-	-	300	
			$T_J=150^\circ C$	-	-	1500	
$I_{GES}$	Gate-Emitter leakage current	$V_{CE}=0V, V_{GE}=\pm 20V$	-	-	$\pm 100$	nA	
$g_{FS}$	Forward Transconductance	$V_{CE}=20V, I_C=15A$	-	7.7	-	S	
<b>DYNAMIC PARAMETERS</b>							
$C_{ies}$	Input Capacitance	$V_{GE}=0V, V_{CE}=25V, f=1MHz$	-	1290	-	pF	
$C_{oes}$	Output Capacitance		-	97	-	pF	
$C_{res}$	Reverse Transfer Capacitance		-	3.1	-	pF	
$Q_g$	Total Gate Charge	$V_{GE}=15V, V_{CE}=480V, I_C=15A$	-	25.4	-	nC	
$Q_{ge}$	Gate to Emitter Charge		-	9.5	-	nC	
$Q_{gc}$	Gate to Collector Charge		-	8.3	-	nC	
$I_{C(SC)}$	Short circuit collector current, Max. 1000 short circuits, Delay between short circuits $\geq 1.0s$	$V_{GE}=15V, V_{CE}=400V, R_G=20\Omega$	-	74	-	A	
$R_g$	Gate resistance	$V_{GE}=0V, V_{CE}=0V, f=1MHz$	-	2.4	-	$\Omega$	
<b>SWITCHING PARAMETERS, (Load Inductive, T<sub>J</sub>=25°C)</b>							
$t_{D(on)}$	Turn-On DelayTime	$T_J=25^\circ C$ $V_{GE}=15V, V_{CE}=400V, I_C=15A,$ $R_G=20\Omega,$ Parasitic Inductance=100nH	-	21	-	ns	
$t_r$	Turn-On Rise Time		-	19	-	ns	
$t_{D(off)}$	Turn-Off Delay Time		-	73	-	ns	
$t_f$	Turn-Off Fall Time		-	10	-	ns	
$E_{on}$	Turn-On Energy		-	0.42	-	mJ	
$E_{off}$	Turn-Off Energy		-	0.11	-	mJ	
$E_{total}$	Total Switching Energy		-	0.53	-	mJ	
$t_{rr}$	Diode Reverse Recovery Time		$T_J=25^\circ C$	-	196	-	ns
$Q_{rr}$	Diode Reverse Recovery Charge		$I_F=15A, dl/dt=200A/\mu s, V_{CE}=400V$	-	0.48	-	$\mu C$
$I_{rm}$	Diode Peak Reverse Recovery Current			-	5.8	-	A
<b>SWITCHING PARAMETERS, (Load Inductive, T<sub>J</sub>=150°C)</b>							
$t_{D(on)}$	Turn-On DelayTime	$T_J=150^\circ C$ $V_{GE}=15V, V_{CE}=400V, I_C=15A,$ $R_G=20\Omega,$ Parasitic Inductance=100nH	-	21	-	ns	
$t_r$	Turn-On Rise Time		-	19	-	ns	
$t_{D(off)}$	Turn-Off Delay Time		-	91	-	ns	
$t_f$	Turn-Off Fall Time		-	8	-	ns	
$E_{on}$	Turn-On Energy		-	0.54	-	mJ	
$E_{off}$	Turn-Off Energy		-	0.19	-	mJ	
$E_{total}$	Total Switching Energy		-	0.73	-	mJ	
$t_{rr}$	Diode Reverse Recovery Time		$T_J=150^\circ C$	-	235	-	ns
$Q_{rr}$	Diode Reverse Recovery Charge		$I_F=15A, dl/dt=200A/\mu s, V_{CE}=400V$	-	1.1	-	$\mu C$
$I_{rm}$	Diode Peak Reverse Recovery Current			-	8.5	-	A

THIS PRODUCT HAS BEEN DESIGNED AND QUALIFIED FOR THE CONSUMER MARKET. APPLICATIONS OR USES AS CRITICAL COMPONENTS IN LIFE SUPPORT DEVICES OR SYSTEMS ARE NOT AUTHORIZED. AOS DOES NOT ASSUME ANY LIABILITY ARISING OUT OF SUCH APPLICATIONS OR USES OF ITS PRODUCTS. AOS RESERVES THE RIGHT TO IMPROVE PRODUCT DESIGN, FUNCTIONS AND RELIABILITY WITHOUT NOTICE.

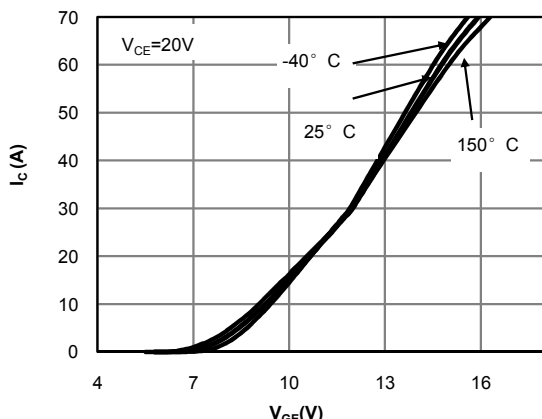
**TYPICAL ELECTRICAL AND THERMAL CHARACTERISTICS**



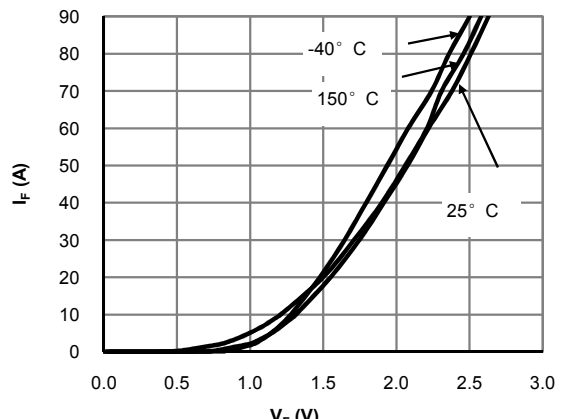
**Fig 1: Output Characteristic**  
( $T_j=25^\circ\text{C}$ )



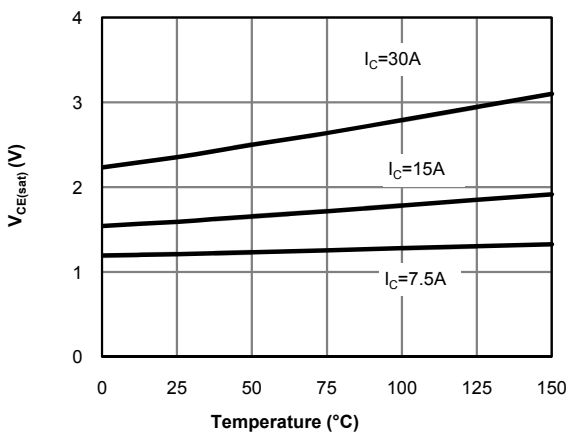
**Fig 2: Output Characteristic**  
( $T_j=150^\circ\text{C}$ )



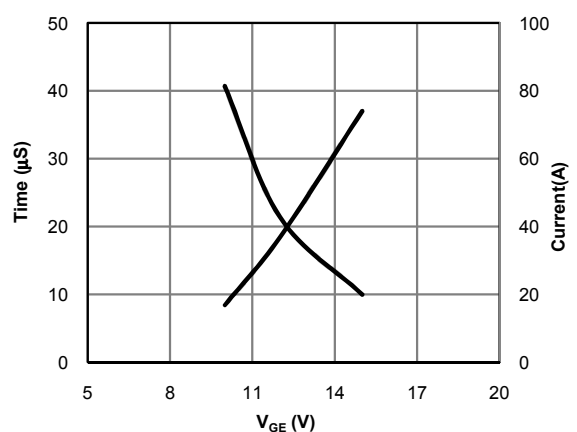
**Fig 3: Transfer Characteristic**



**Fig 4: Diode Characteristic**

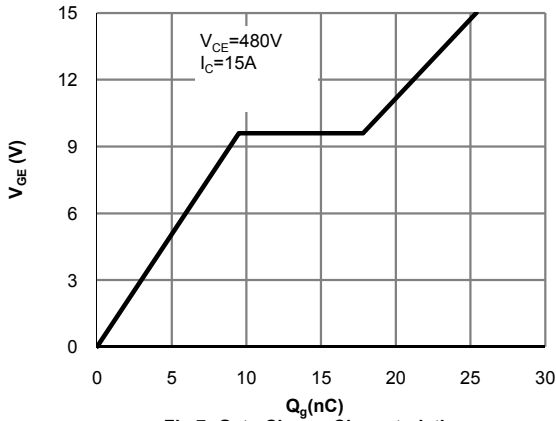


**Fig 5: Collector-Emitter Saturation Voltage vs. Junction Temperature**

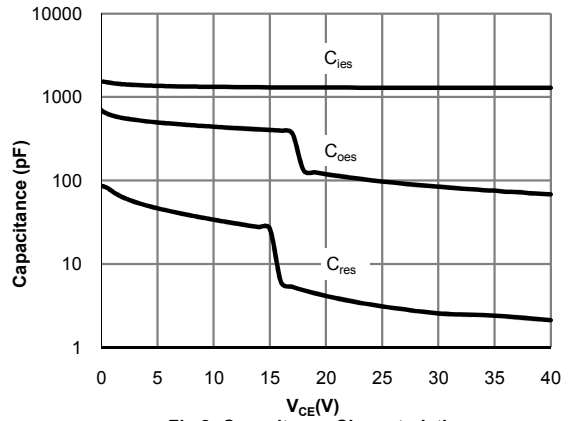


**Fig 6:  $V_{GE}$  vs. Short Circuit Time**  
( $V_{CE}=400V, T_C=25^\circ\text{C}$ )

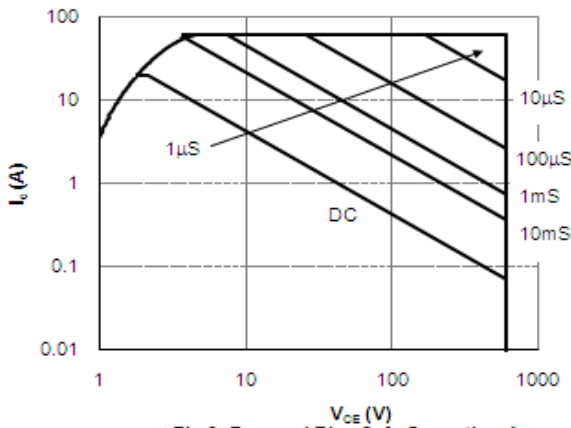
**TYPICAL ELECTRICAL AND THERMAL CHARACTERISTICS**



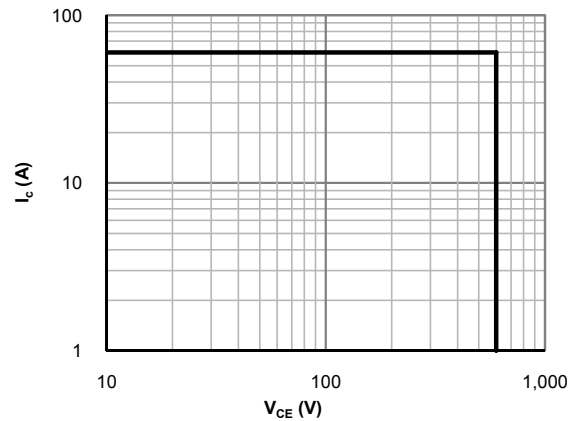
**Fig 7: Gate-Charge Characteristics**



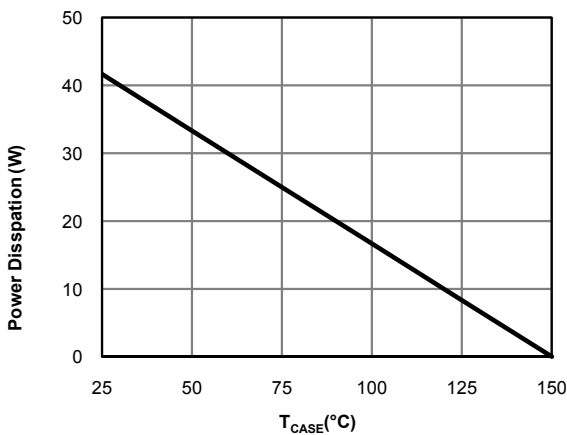
**Fig 8: Capacitance Characteristic**



**Fig 9: Forward Bias Safe Operating Area**  
( $T_c=25^{\circ}\text{C}, V_{GE}=15\text{V}$ )

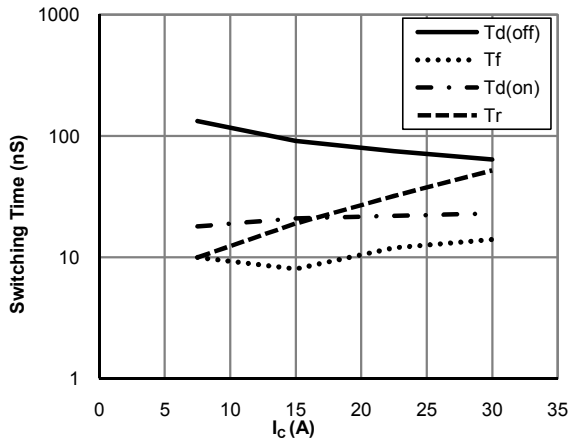


**Fig 10: Reverse Bias SOA**  
( $T_J=150^{\circ}\text{C}, V_{GE}=15\text{V}$ )

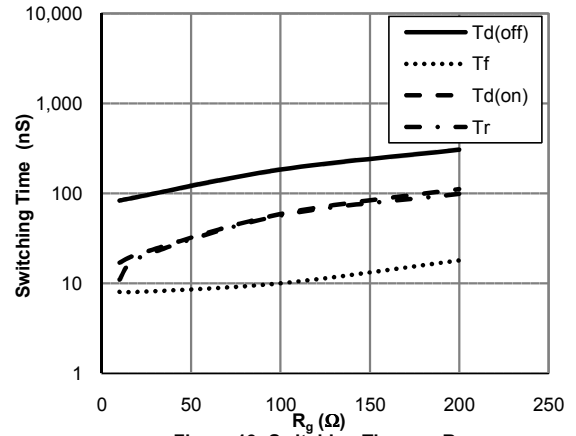


**Fig 11: Power Dissipation as a Function of Case**

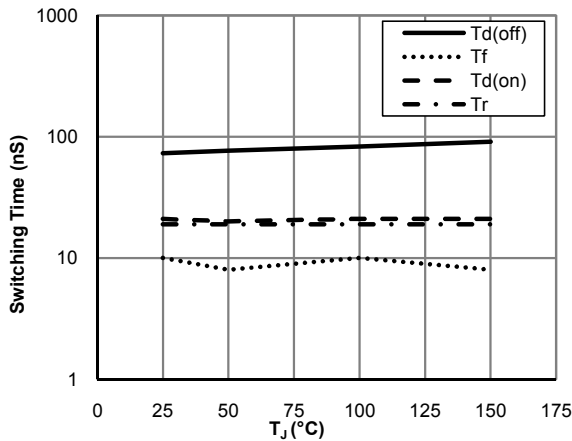
**TYPICAL ELECTRICAL AND THERMAL CHARACTERISTICS**



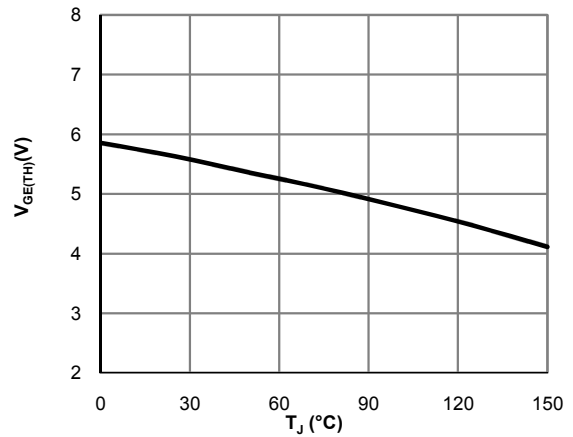
**Figure 12: Switching Time vs.  $I_c$**   
( $T_j=150^\circ\text{C}, V_{GE}=15\text{V}, V_{CE}=400\text{V}, R_g=20\Omega$ )



**Figure 13: Switching Time vs.  $R_g$**   
( $T_j=150^\circ\text{C}, V_{GE}=15\text{V}, V_{CE}=400\text{V}, I_c=15\text{A}$ )

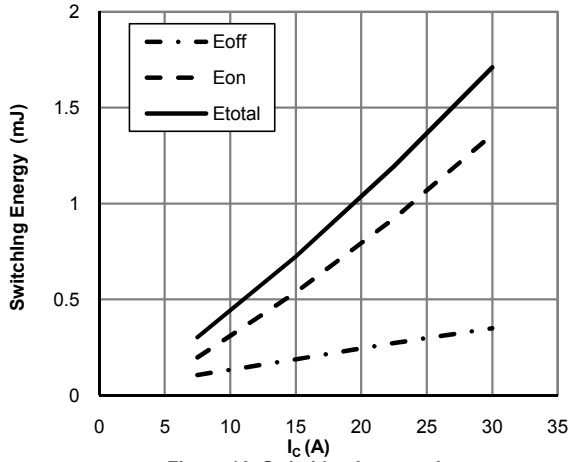


**Figure 14: Switching Time vs.  $T_j$**   
( $V_{GE}=15\text{V}, V_{CE}=400\text{V}, I_c=15\text{A}, R_g=20\Omega$ )

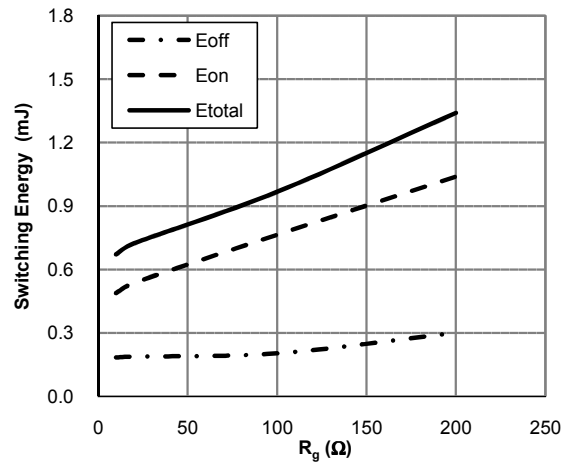


**Figure 15:  $V_{GE(TH)}$  vs.  $T_j$**

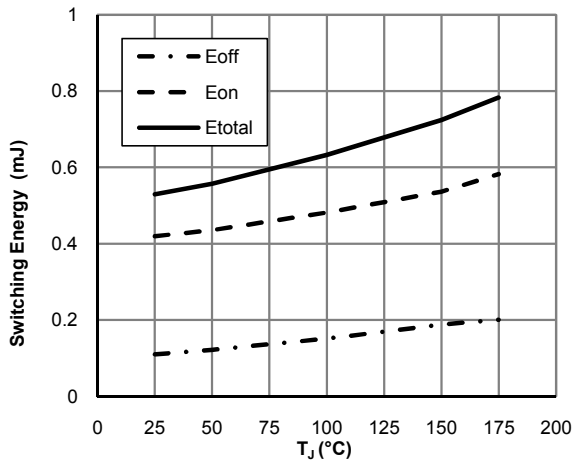
**TYPICAL ELECTRICAL AND THERMAL CHARACTERISTICS**



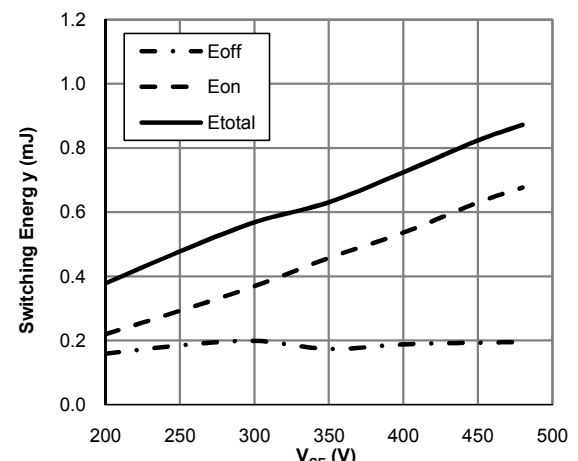
**Figure 16: Switching Loss vs.  $I_c$**   
( $T_j=150^\circ\text{C}, V_{GE}=15\text{V}, V_{CE}=400\text{V}, R_g=20\Omega$ )



**Figure 17: Switching Loss vs.  $R_g$**   
( $T_j=150^\circ\text{C}, V_{GE}=15\text{V}, V_{CE}=400\text{V}, I_c=15\text{A}$ )

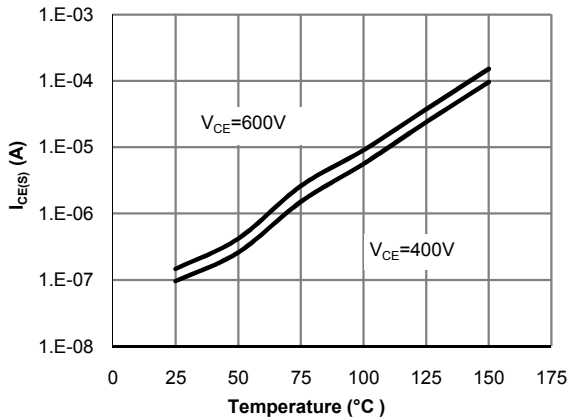


**Figure 18: Switching Loss vs.  $T_j$**   
( $V_{GE}=15\text{V}, V_{CE}=400\text{V}, I_c=15\text{A}, R_g=20\Omega$ )

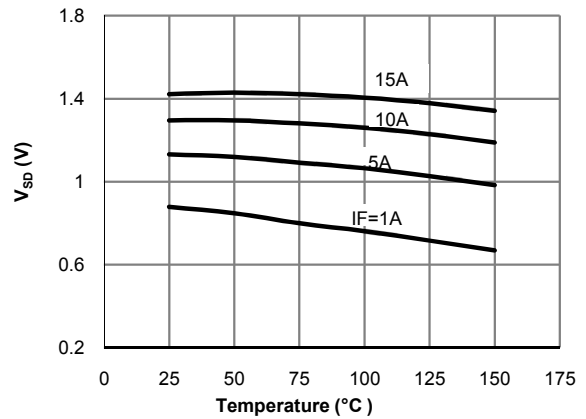


**Figure 19: Switching Loss vs.  $V_{CE}$**   
( $T_j=150^\circ\text{C}, V_{GE}=15\text{V}, I_c=15\text{A}, R_g=20\Omega$ )

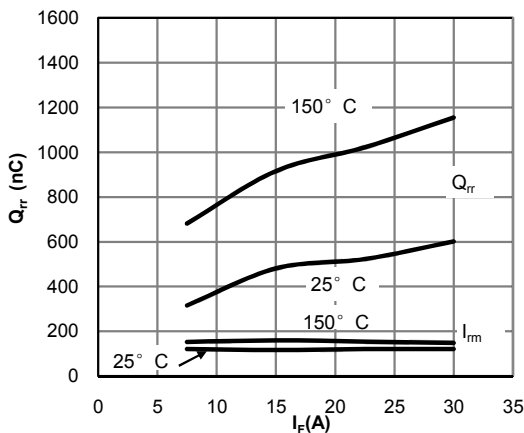
**TYPICAL ELECTRICAL AND THERMAL CHARACTERISTICS**



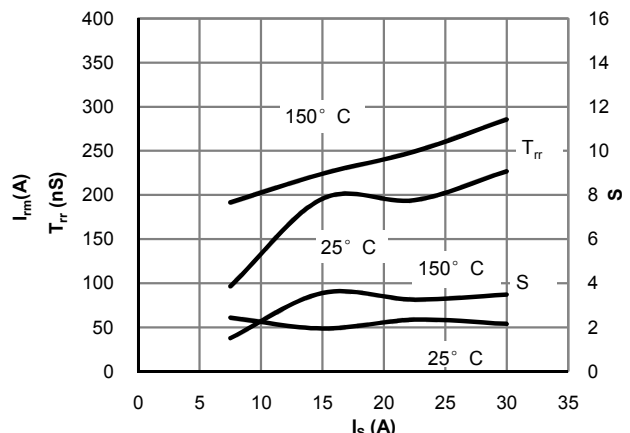
**Fig 20: Diode Reverse Leakage Current vs. Junction Temperature**



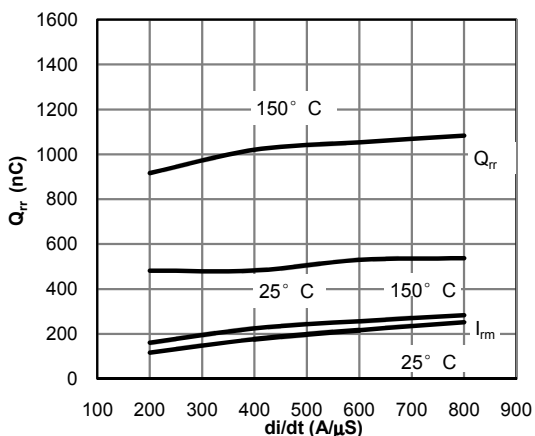
**Fig 21: Diode Forward Voltage vs. Junction Temperature**



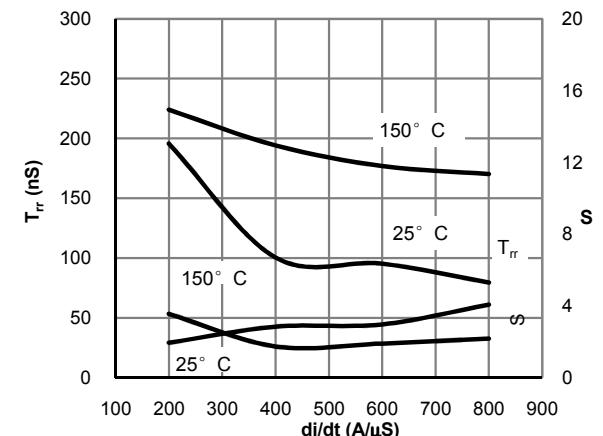
**Fig 22: Diode Reverse Recovery Charge and Peak Current vs. Conduction Current**  
( $V_{GE}=15V, V_{CE}=400V, di/dt=200A/\mu s$ )



**Fig 23: Diode Reverse Recovery Time and Softness Factor vs. Conduction Current**  
( $V_{GE}=15V, V_{CE}=400V, di/dt=200A/\mu s$ )

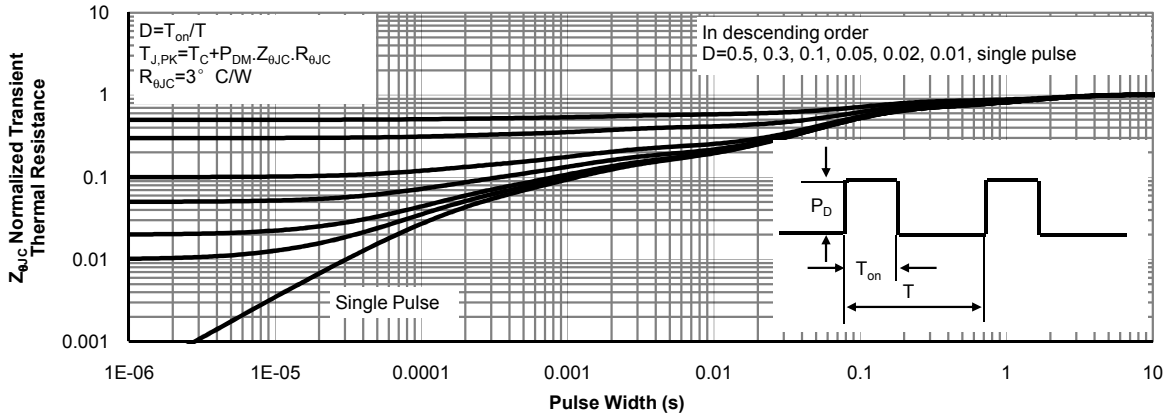


**Fig 24: Diode Reverse Recovery Charge and Peak Current vs. di/dt**  
( $V_{GE}=15V, V_{CE}=400V, I_F=15A$ )

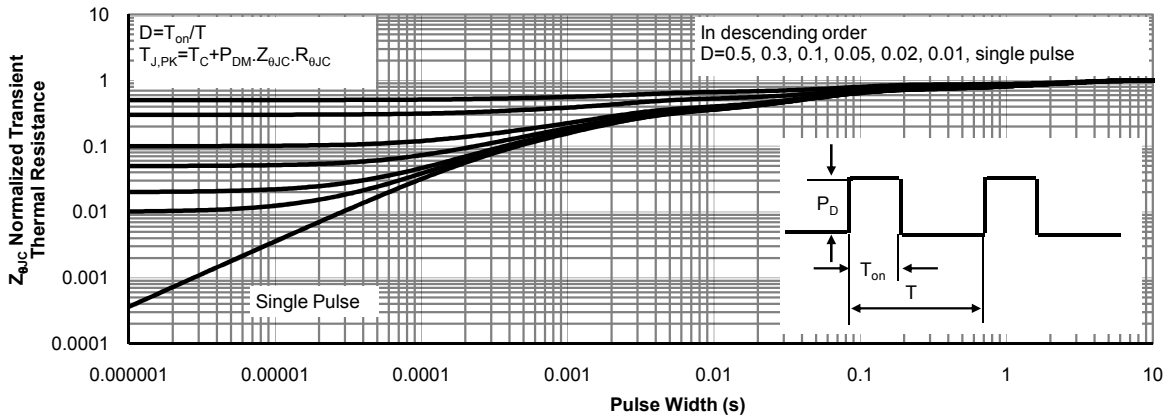


**Fig 25: Diode Reverse Recovery Time and Softness Factor vs. di/dt**  
( $V_{GE}=15V, V_{CE}=400V, I_F=15A$ )

**TYPICAL ELECTRICAL AND THERMAL CHARACTERISTICS**



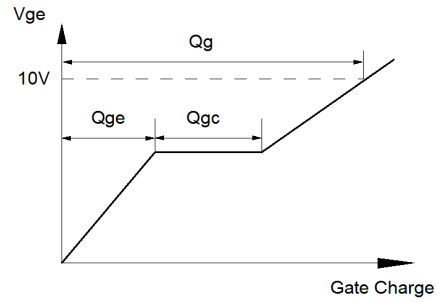
**Figure 26: Normalized Maximum Transient Thermal Impedance for IGBT**



**Figure 27: Normalized Maximum Transient Thermal Impedance for Diode**



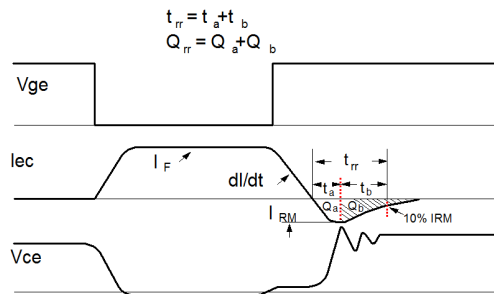
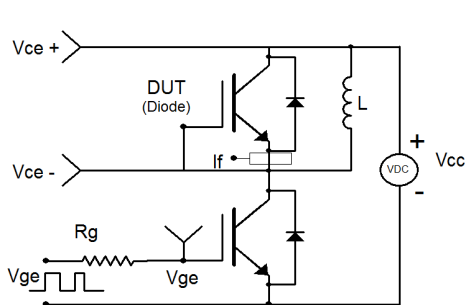
**Gate Charge Test Circuit & Waveform**



**Inductive Switching Test Circuit & Waveforms**



**Diode Recovery Test Circuit & Waveforms**



## X-ON Electronics

Largest Supplier of Electrical and Electronic Components

*Click to view similar products for [IGBT Transistors category](#):*

*Click to view products by [Alpha & Omega manufacturer](#):*

Other Similar products are found below :

[748152A](#) [APT20GT60BRDQ1G](#) [NGTB10N60FG](#) [IGP30N60H3XKSA1](#) [STGFW20V60DF](#) [APT30GP60BG](#) [APT45GR65B2DU30](#)  
[GT50JR22\(STA1ES\)](#) [TIG058E8-TL-H](#) [VS-CPV364M4KPBFB](#) [NGTB25N120FL2WAG](#) [NGTG40N120FL2WG](#) [RJH60F3DPQ-A0#T0](#)  
[APT40GR120B2SCD10](#) [APT15GT120BRG](#) [APT20GT60BRG](#) [NGTB75N65FL2WAG](#) [NGTG15N120FL2WG](#) [APT70GR65B2DU40](#)  
[NTE3320](#) [FGD3440G2-F085](#) [APT70GR120J](#) [APT35GP120JDQ2](#) [IKFW40N65ES5XKSA1](#) [IMBG120R220M1HXTMA1](#)  
[IGW30N60H3FKSA1](#) [STGWA8M120DF3](#) [IGB30N60H3ATMA1](#) [IGW100N60H3FKSA1](#) [IGW75N60H3FKSA1](#) [HGTG40N60B3](#)  
[IRGS4715DPBF](#) [FGH60N60SMD\\_F085](#) [FGH75T65UPD](#) [STGWA15H120F2](#) [IKA10N60TXKSA1](#) [IHW20N120R5XKSA1](#)  
[IKW25N120T2FKSA1](#) [IHW20N65R5XKSA1](#) [IDW40E65D2FKSA1](#) [STGWT60H65FB](#) [STGWT60H65DFB](#) [STGWT40V60DF](#)  
[STGWT20V60DF](#) [STGB10NB37LZT4](#) [FGH40T70SHD-F155](#) [FGD3245G2\\_F085](#) [NGTB40N65IHL2WG](#) [HGTG30N60C3D](#)  
[HGTG30N60A4D](#)