

9mm Rotary Type, Snap-In, Insulated Shaft

Application

- ✓ TV/Video, Audio, Home appliance, Industrial control

Feature

- ✓ Smooth rotation feeling



■Specification

| | |
|---------------------------------------|--|
| Total Rotational Angle | RV09A series: 280±5° , RV09B series: 300±5° |
| Maximum Operating Voltage | 50V AC |
| Insulation Resistance | 100MΩ at DC250V |
| Dielectric Strength | AC250V for 1 minute |
| Rotational Torque | 10-100 gf.cm |
| Click Torque | 20-120 gf.cm |
| Rotational Stop Strength of the Shaft | 3 kgs.cm min |
| Push/Pull Strength of the Shaft | 5kgs for 3 sec |
| Operating Temperature Range | -10 °C~70°C |
| Rotation Life | With click: 5,000 cycles, without click: 10,000 cycles |

■How to order

RV09AF-20 – 15F - B10K - 0C

[Model](#)

[Shaft Type](#)

Taper and Resistance Value

| Order Code | Taper | Resistance Value |
|------------|-----------|------------------|
| A100K | Log/A | 100KΩ |
| B1M | Linear/B | 1MΩ |
| C500K | Rev-log/C | 500KΩ |

Taper: A, B and C

Resistance Value: 1KΩ to 500KΩ and 1MΩ

*Contact us for other requirements.

Click

| Order Code | Description |
|------------|-------------------|
| Blank | No click |
| 0C | With center click |





9mm Rotary Type, Snap-In, Insulated Shaft

■ Model Description

| Model | Number of Unit | Terminal Type | With Sleeve or Bushing | Rotational Angle | Mounting Height |
|------------------------------|----------------|---------------|------------------------|------------------|-----------------|
| RV09ACF-20 | Single unit | Horizontal | Sleeve | 280°±5° | 10 mm |
| RV09BCF-20 | Single unit | Horizontal | Sleeve | 300°±5° | 10 mm |
| RV09ACF-40 | Single unit | Vertical | Sleeve | 280°±5° | 7.0 mm |
| RV09BCF-40 | Single unit | Vertical | Sleeve | 300°±5° | 7.0 mm |
| RV09AF-20 | Single unit | Horizontal | N/A | 280°±5° | 10 mm |
| RV09AF-21 | Single unit | Horizontal | N/A | 280°±5° | 6.5 mm |
| RV09BF-20 | Single unit | Horizontal | N/A | 300°±5° | 10 mm |
| RV09BF-21 | Single unit | Horizontal | N/A | 300°±5° | 6.5 mm |
| RV09AF-40 | Single unit | Vertical | N/A | 280°±5° | 7.0 mm |
| RV09BF-40 | Single unit | Vertical | N/A | 300°±5° | 7.0 mm |
| RV09AF-20E1N | Single unit | Horizontal | Plastic bushing | 280°±5° | 10 mm |
| RV09BF-20E1N | Single unit | Horizontal | Plastic bushing | 300°±5° | 10 mm |
| RV09AF-40E1N | Single unit | Vertical | Plastic bushing | 280°±5° | 7.0 mm |
| RV09BF-40E1N | Single unit | Vertical | Plastic bushing | 300°±5° | 7.0 mm |
| RV09AF-20E1 | Single unit | Horizontal | Metal bushing | 280°±5° | 10 mm |
| RV09BF-20E1 | Single unit | Horizontal | Metal bushing | 300°±5° | 10 mm |
| RV09AF-40E1 | Single unit | Vertical | Metal bushing | 280°±5° | 7.0 mm |
| RV09BF-40E1 | Single unit | Vertical | Metal bushing | 300°±5° | 7.0 mm |

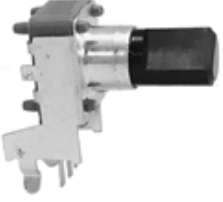
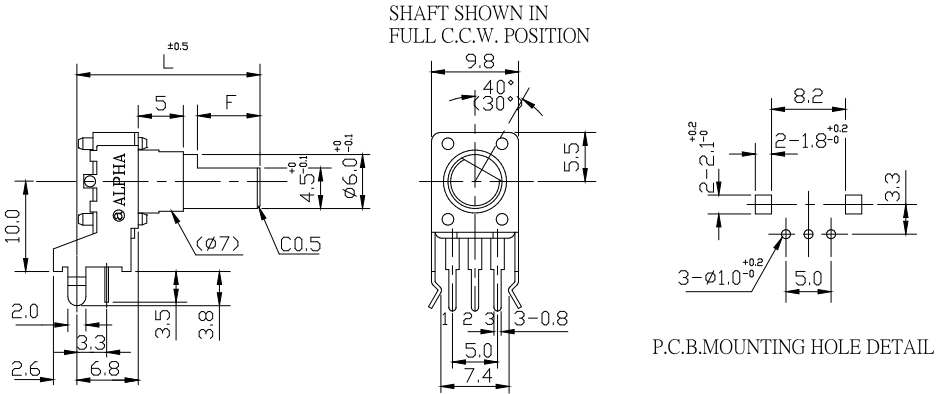

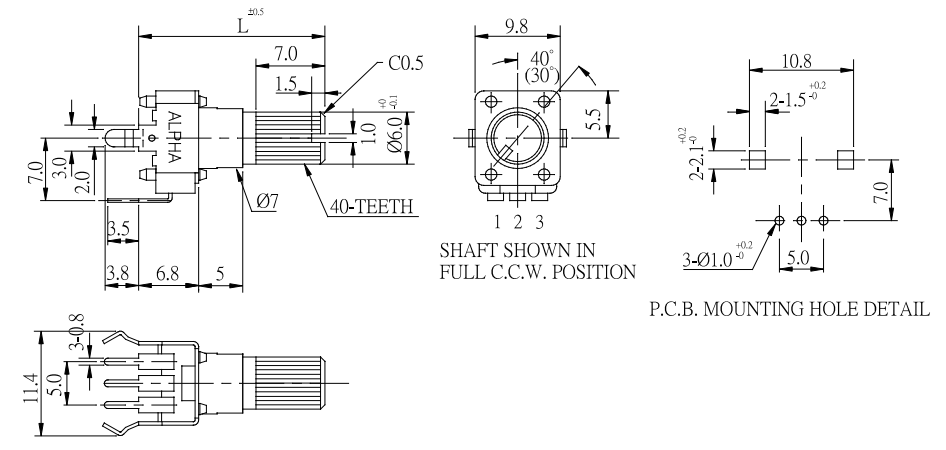
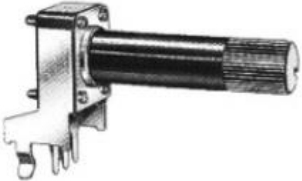
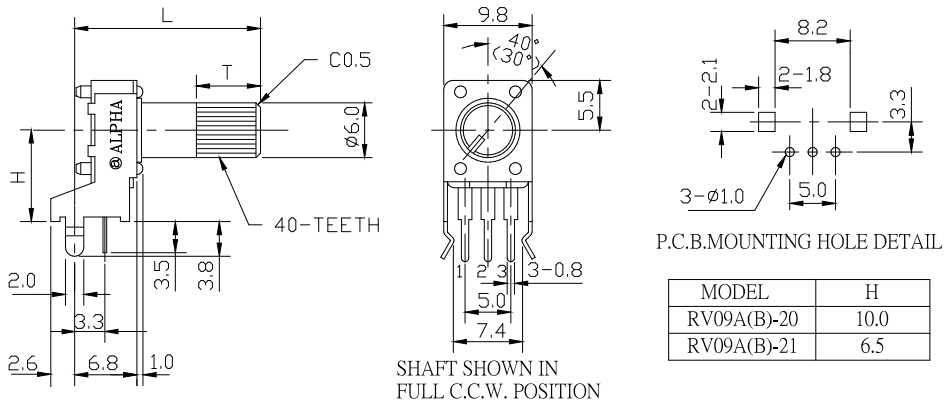

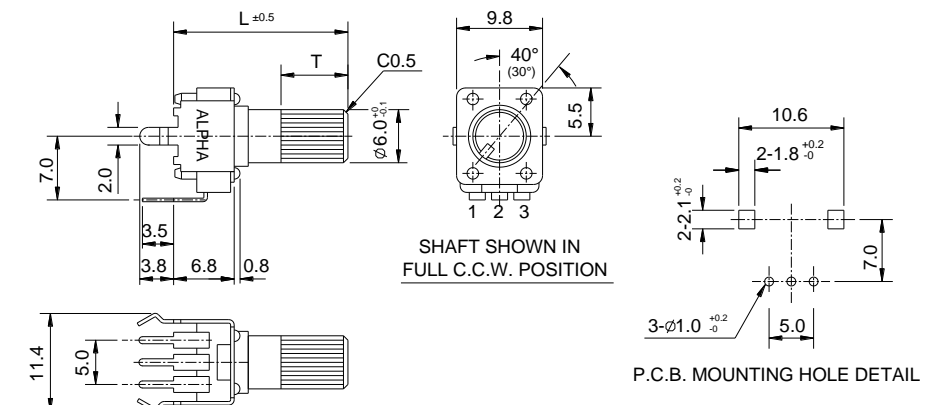

[Back to top](#)

9mm Rotary Type, Snap-In, Insulated Shaft

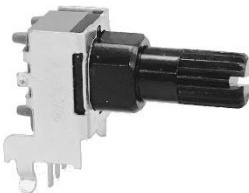
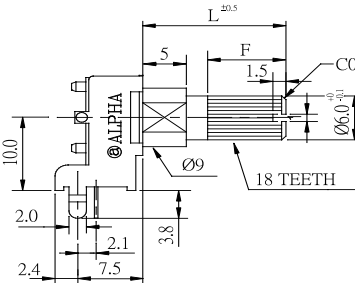
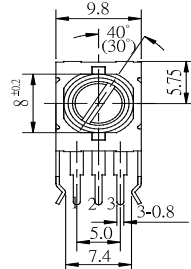
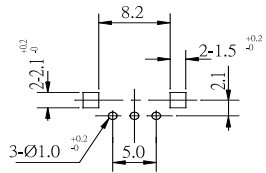
| Order Code | Outline Drawing | | | | | | |
|---|--|-------|---|-------------|------|-------------|-----|
| RV09ACF-20 RV09BCF-20  |  <p>SHAFT SHOWN IN FULL C.C.W. POSITION</p> <p>P.C.B. MOUNTING HOLE DETAIL</p> | | | | | | |
| RV09ACF-40 RV09BCF-40  |  <p>SHAFT SHOWN IN FULL C.C.W. POSITION</p> <p>P.C.B. MOUNTING HOLE DETAIL</p> | | | | | | |
| RV09AF-20, RV09BF-20 RV09AF-21, RV09BF-21  |  <p>SHAFT SHOWN IN FULL C.C.W. POSITION</p> <p>P.C.B. MOUNTING HOLE DETAIL</p> <table border="1" data-bbox="1228 1489 1492 1579"> <thead> <tr> <th>MODEL</th> <th>H</th> </tr> </thead> <tbody> <tr> <td>RV09A(B)-20</td> <td>10.0</td> </tr> <tr> <td>RV09A(B)-21</td> <td>6.5</td> </tr> </tbody> </table> | MODEL | H | RV09A(B)-20 | 10.0 | RV09A(B)-21 | 6.5 |
| MODEL | H | | | | | | |
| RV09A(B)-20 | 10.0 | | | | | | |
| RV09A(B)-21 | 6.5 | | | | | | |
| RV09AF-40 RV09BF-40  |  <p>SHAFT SHOWN IN FULL C.C.W. POSITION</p> <p>P.C.B. MOUNTING HOLE DETAIL</p> | | | | | | |

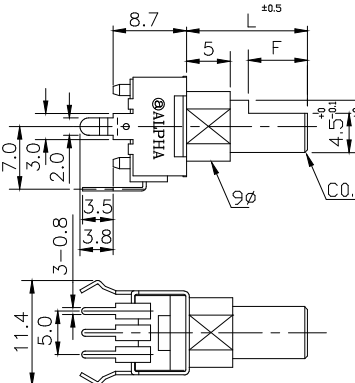
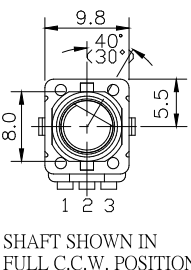
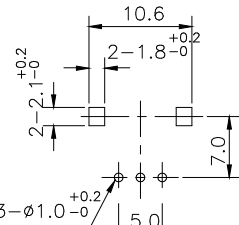
[Back to top](#)

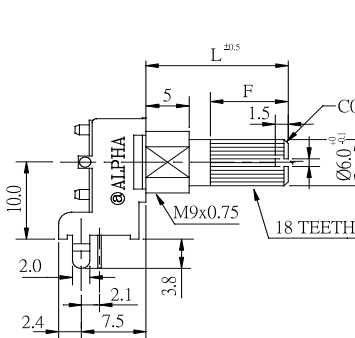
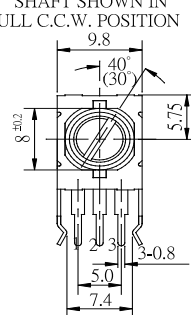
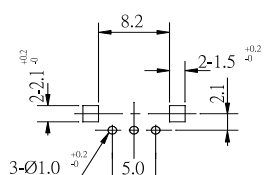
9mm Rotary Type, Snap-In, Insulated Shaft

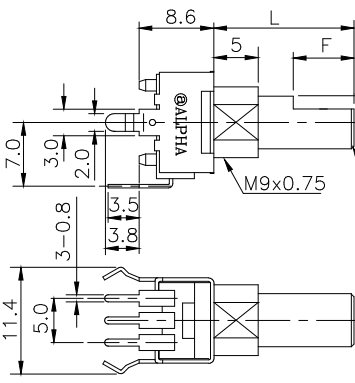
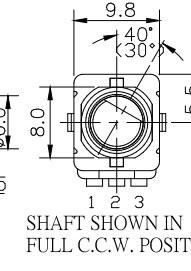
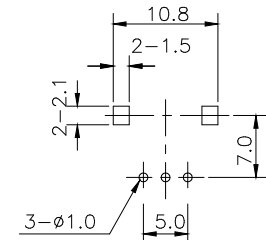
| Order code | Outline Drawing | | |
|--|---|---|--|
| RV09AF-20E1N RV09BF-20E1N  |  | SHAFT SHOWN IN FULL C.C.W. POSITION  |  <p>P.C.B. MOUNTING HOLE DETAIL</p> |
| RV09AF-40E1N RV09BF-40E1N  |  | SHAFT SHOWN IN FULL C.C.W. POSITION  |  <p>P.C.B. MOUNTING HOLE DETAIL</p> |
| RV09AF-20E1 RV09BF-20E1  |  | SHAFT SHOWN IN FULL C.C.W. POSITION  |  <p>P.C.B. MOUNTING HOLE DETAIL</p> |
| RV09AF-40E1 RV09BF-40E1  |  | SHAFT SHOWN IN FULL C.C.W. POSITION  |  <p>P.C.B. MOUNTING HOLE DETAIL</p> |

[Back to top](#)

9mm Rotary Type, Snap-In, Insulated Shaft

■ K TYPE

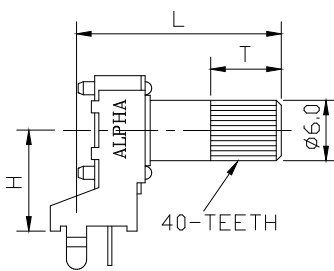
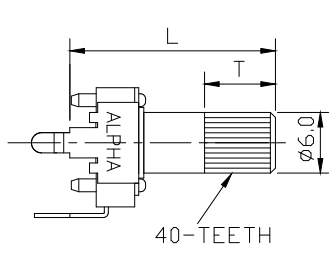
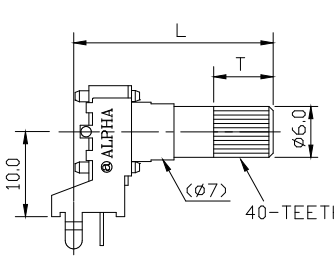
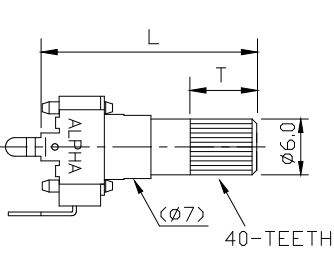
| | | | |
|--|---|--|---|
| RV09AF-20(21)-(L)K RV09BF-20(21)-(L)K | RV09AF-40-(L)K RV09BF-40-(L)K | RV09ACF-20-(L)K RV09BCF-20-(L)K | RV09ACF-40-(L)K RV09BCF-40-(L)K |
|  |  |  |  |

RV09AF, RV09ACF

| Order Code | 15K | 20K | 25K | 30K |
|------------|-----|-----|-----|-----|
| L | 15 | 20 | 25 | 30 |
| T | 7 | 7 | 7 | 7 |

RV09BF, RV09BCF

| Order Code | 20K | 25K | 30K |
|------------|-----|-----|-----|
| L | 20 | 25 | 30 |
| T | 7 | 7 | 7 |

**15 mm shaft is not available for RV09ACF/BCF models.

| | |
|--|--|
| RV09AF-20E1N-(L)K RV09BF-20E1N-(L)K RV09AF-20E1-(L)K RV09BF-20E1-(L)K | RV09AF-40E1N-(L)K RV09BF-40E1N-(L)K RV09AF-40E1-(L)K RV09BF-40E1-(L)K |
|--|--|

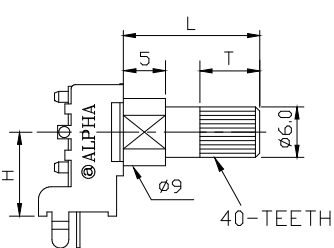
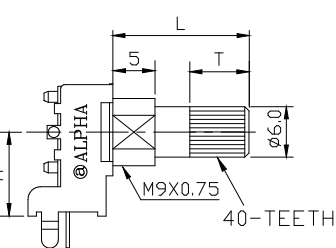
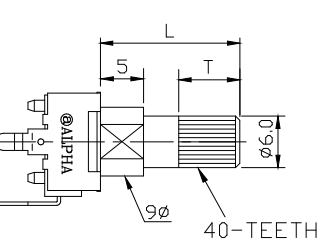
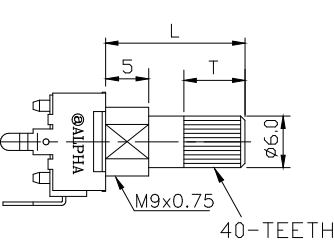
| | | | |
|--|---|--|---|
|  |  |  |  |
| H=10 | | | |

| Order Code | 165K | 25K |
|------------|------|------|
| L | 16.5 | 21.5 |
| T | 7 | 7 |

[Back to top](#)

9mm Rotary Type, Snap-In, Insulated Shaft

■ F TYPE

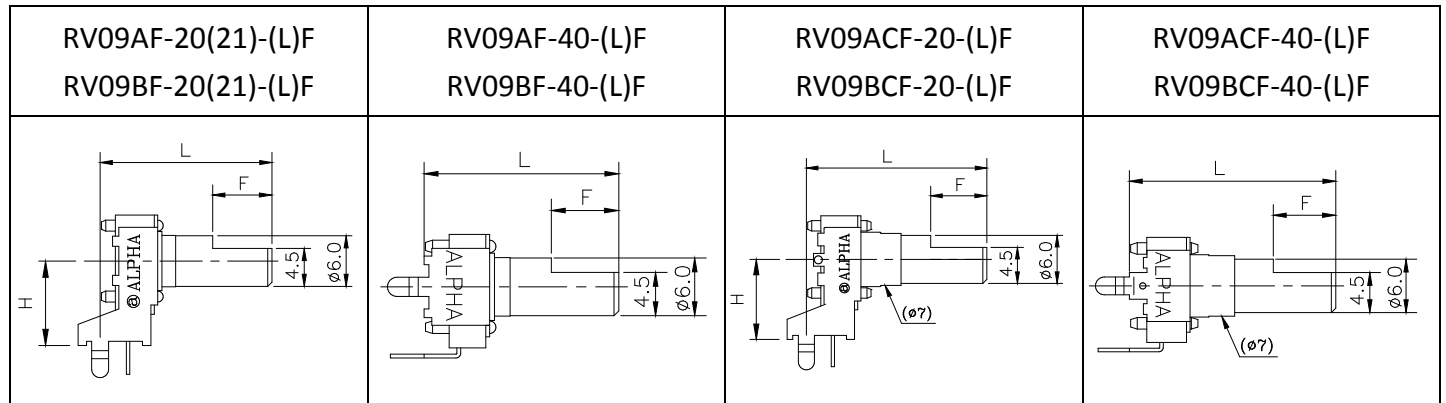

RV09AF, RV09ACF

| Order Code | *15F | 20F | 21F | 25F | 26F | 30F | 31F | 375F |
|------------|------|-----|-----|-----|-----|-----|-----|------|
| L | 15 | 20 | 21 | 25 | 26 | 30 | 31 | 37.5 |
| F | 6 | 7 | 7 | 7 | 12 | 12 | 12 | 12 |

RV09BF, RV09BCF

| Order Code | *15F | 20F | 21F | 235F | 25F | 26F | 30F | 31F | 335F | 35F | 375F |
|------------|------|-----|-----|------|-----|------|-----|-----|------|-----|------|
| L | 15 | 20 | 21 | 23.5 | 25 | 26 | 30 | 31 | 33.5 | 35 | 37.5 |
| F | 6 | 7 | 7 | 7 | 7 | 8.25 | 12 | 12 | 12 | 12 | 12 |

**15 mm shaft is not available for RV09ACF/BCF models.

RV09AF-20E1N-(L)F
RV09BF-20E1N-(L)F
RV09AF-20E1-(L)F
RV09BF-20E1-(L)F

RV09AF-40E1N-(L)F
RV09BF-40E1N-(L)F
RV09AF-40E1-(L)F
RV09BF-40E1-(L)F

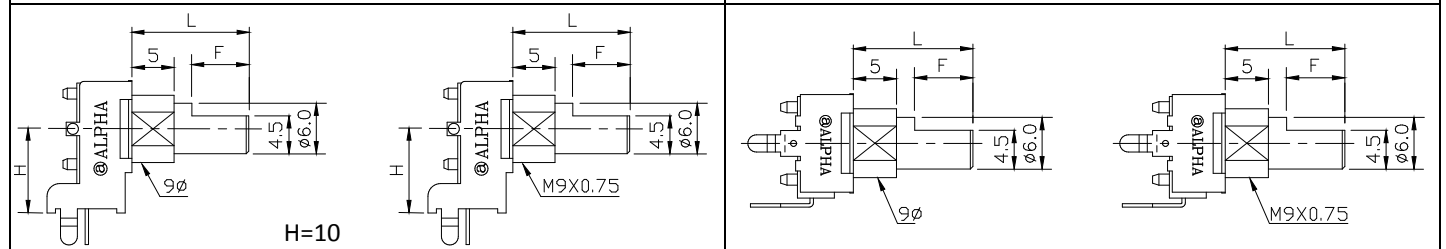

RV09AF

| Order Code | 115F | 125F | 165F | 175F | 215F | 225F | 29F |
|------------|------|------|------|------|------|------|-----|
| L | 11.5 | 12.5 | 16.5 | 17.5 | 21.5 | 22.5 | 29 |
| F | 6.5 | 7 | 7 | 12 | 12 | 12 | 12 |

RV09BF

| Order Code | 115F | 125F | 15F | 165F | 165F | 165F | 175F | 215F | 225F | 25F | 265F | 29F |
|------------|------|------|-----|------|------|------|------|------|------|-----|------|-----|
| L | 11.5 | 12.5 | 15 | 16.5 | 16.5 | 16.5 | 17.5 | 21.5 | 22.5 | 25 | 26.5 | 29 |
| F | 6.5 | 7 | 7 | 7 | 8.25 | 12 | 12 | 12 | 12 | 12 | 12 | 12 |

[Back to top](#)

9mm Rotary Type, Snap-In, Insulated Shaft

■ B TYPE

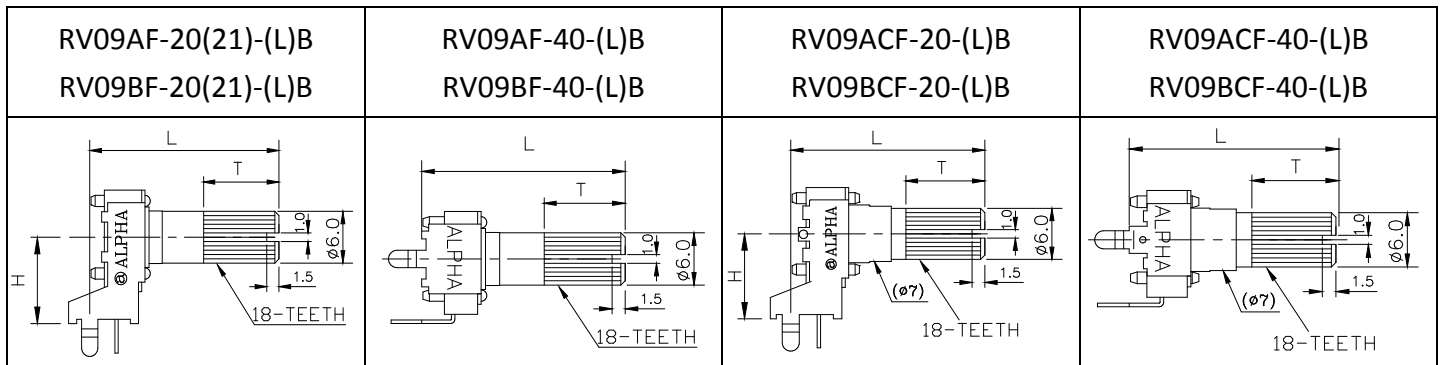

RV09AF, RV09ACF

| Order Code | 15B | 20B | 25B | 30B |
|------------|-----|-----|-----|-----|
| L | 15 | 20 | 25 | 30 |
| T | 7 | 7 | 7 | 7 |

RV09BF, RV09BCF

| Order Code | 20B | 25B | 30B | 33B |
|------------|-----|-----|-----|-----|
| L | 20 | 25 | 30 | 33 |
| T | 7 | 7 | 7 | 7 |

**15 mm shaft is not available for RV09ACF/BCF models.

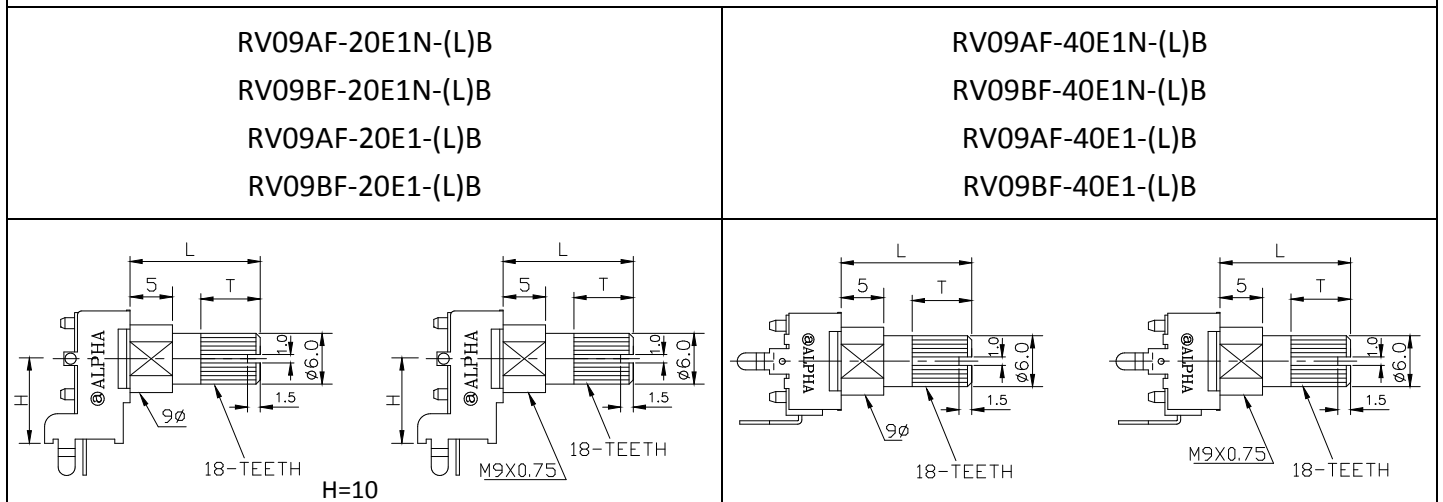

RV09AF

| Order Code | 115B | 165B | 215B |
|------------|------|------|------|
| L | 11.5 | 16.5 | 21.5 |
| T | 7 | 7 | 7 |

RV09BF

| Order Code | 115B | 165B | 215B | 25B |
|------------|------|------|------|-----|
| L | 11.5 | 16.5 | 21.5 | 25 |
| T | 7 | 7 | 7 | 7 |

Design and specifications presented here are for the standard parts only. Please kindly contact us for your special requests and ask for the current technical specifications before purchase and/or use.

[Back to top](#)

X-ON Electronics

Largest Supplier of Electrical and Electronic Components

Click to view similar products for [Potentiometers](#) category:

Click to view products by [Alpha Taiwan](#) manufacturer:

Other Similar products are found below :

[58C2-2](#) [590SX1N32F103SS](#) [591SXP56S252SC](#) [D31409](#) [70B1G048K502X-A](#) [70B1M032S502W](#) [70B1N056S202W](#) [70B8N056F502W](#)
[70J8N048S104U](#) [70L1N040P103W](#) [70L1N048P103X](#) [70L1N048S103W](#) [GA2L040S102UC](#) [GA2L040S103UC](#) [GS1G044P103UA](#)
[GS1N048P103UA](#) [GS1T032S103UA](#) [A43-1500](#) [A43-20K](#) [A47-200K](#) [A4720K](#) [132-2-0-202](#) [132-0-0-202](#) [RK14K1220-F25-C0-A103](#)
[RK14K1220F25C0C104](#) [RK14K1220-F25-C1-B103](#) [14910FAGJSX10102KA](#) [14910FBGLFY00103KA](#) [14910AABHSX10103KA](#)
[14910FAGJSX10104KA](#) [152-01031](#) [C0342008 5K](#) [J97589](#) [23M728](#) [248BBHS0XB25104MA](#) [248BBHS0XB25503MA](#)
[249FGJS0XB25503KA](#) [RV170F-10-15R1-B500K-0021](#) [917523A](#) [A43-40](#) [A43-750](#) [A43S-5](#) [A47-15K](#) [A47-1K](#) [A4750K](#) [SPPG048S103U](#)
[SPPG056P103U](#) [SWE-10](#) [GA2G040F103BA](#) [249FGJS0XB25102KA](#)