

CLASS No.	TITLE 回転形エンコーダ 規格書 ROTATIONAL ENCODER SPECIFICATION	(SW01)
-----------	---	--------

1. 一般事項 General

1-1 適用範囲 Scope

この仕様書は主として電子機器に用いる微小電流回路用9形薄形ロータリーエンコーダに適用する。  
This specification applies to 9mm size low-profile rotary encoder (incremental type) for microscopic current circuits, used in electronic equipment.

1-2 標準状態 Standard atmospheric conditions

測定は特に指定のない限り、次の状態で行なう。  
Unless otherwise specified, the standard range of atmospheric conditions for making measurements and tests is as follows:

温度 Ambient temperature : 15°C to 30°C  
 相対湿度 Relative humidity : 25% to 85%  
 気圧 Air pressure : 86kPa to 106kPa

但し、疑義を生じた場合は、次の基準状態で行なう。

If there is any doubt about the results, measurements shall be made within the following limits:

温度 Ambient temperature : 25 ± 1°C  
 相対湿度 Relative humidity : 63% to 67%  
 気圧 Air pressure : 86kPa to 106kPa

1-3 使用温度範囲

Operating temperature range : -40°C to +85°C

1-4 保存温度範囲

Storage temperature range : -40°C to +85°C

2. 構造 Construction

2-1 寸法 Dimensions

添付組立図による。  
Refer to attached drawing.

3. 定格 Rating

3-1 定格容量 Rating

: D.C. 5V 10mA 抵抗負荷 (最大定格) Resistive load (Maximum rating)  
 1mA 抵抗負荷 (最小定格) Resistive load (Minimum rating)

4. 電気的性能 Electrical characteristics

項目 Item	条件 Conditions	規格 Specifications
4-1 出力信号 Output signal format	(クリック付きの場合に適用) (Applied for with-detent type) 注意事項: ハルス出力は2クリックで1ハルス出力となっております。又、クリック位置にてA-C端子出力がON、又はOFFとなっております。B-C端子出力のクリック位置での規定はしてありません。 Note: Output signal is 1 pulse per 2 detents. And terminal A-C is pulse ON or OFF at detent position. No specified output of terminal B-C at detent position.  <Fig 1>	A, B信号の位相差出力とし、詳細は<fig. 1>の通りとする。 (破線はクリック付きの場合のクリックの位置を示す。) 2 Phase-different signals (Signal A, signal B) Details shown in <fig. 1>. (The broken line shows detent position of with-detent type.)
	軸回転方向 Shaft rotational direction	出力波形 Output
	時計方向 C. W.	A (A-C端子間) A(Terminal A-C)  B (B-C端子間) B(Terminal B-C)
	反時計方向 C. C. W.	A (A-C端子間) A(Terminal A-C)  B (B-C端子間) B(Terminal B-C)

**ALPS ALPS ELECTRIC CO., LTD.**

APPD.	CHKD.	DSGD.	TITLE
1-2G	1-2G	1-2G	9形回転形エンコーダ 9mm SIZE ROTATIONAL ENCODER
00/01/14	00/01/14	99/12/27	DOCUMENT NO.
K. ITO	H. SHIMOMURA	Y. KANZAKI	5LA209-1 (1/6)

SYMB	DATE	APPD	CHKD	DSGD
------	------	------	------	------

CLASS NO.	TITLE 回転形エンコーダ 規格書 ROTATIONAL ENCODER SPECIFICATION	(SW01)
-----------	---	--------

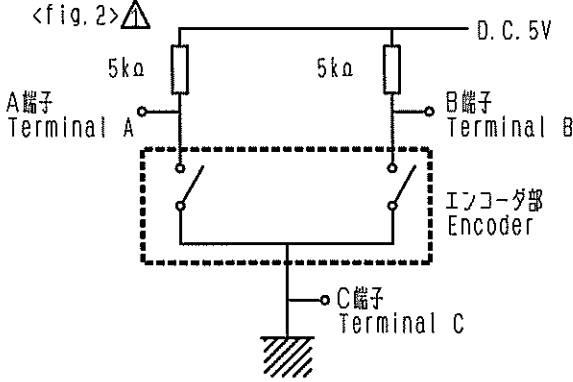
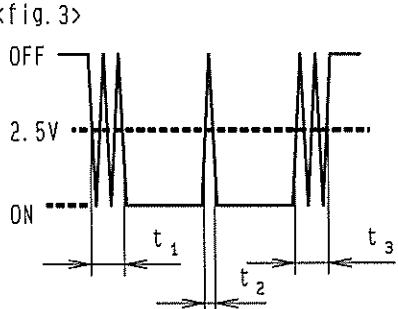
項目 Item	条件 Conditions	規格 Specifications	
4-2 分解能 Resolution	1回転にて出力されるパルス数 Number of pulses in 360° rotation.	各相15パルス/360° 15 pulses/360° for each phase  → (クリック付きの場合に適用) (Applied for with-detent type)  2クリック 1パルス 2click 1pulse	
4-3 スイッチング特性 Switching characteristics	下記測定回路<fig. 2>を用い、回転角を360°・s <sup>-1</sup> の速さで回転し測定する。 Measurement shall be made under the condition as follows. 1) Shaft rotational speed : 360°・s <sup>-1</sup> 2) Test circuit : <fig. 2>  <fig. 2>   <fig. 3> 		
1)	チャタリング Chattering	コードのOFF→ON及びON→OFFの際の、出力2.5Vの通過時間で規定する。 Specified by the signal's passage time from 2.5V or each switching position (code OFF→ON or ON→OFF).	t <sub>1</sub> , t <sub>3</sub> ≤ 5ms
2)	揺動ノイズ (バウンス) Sliding noise (Bounce)	コードONの部分の2.5V以上の電圧変動時間とし、チャタリングt <sub>1</sub> , t <sub>3</sub> 両者との間に5ms以上の2.5V以下のON部分を有するものとする。また、揺動ノイズ間2.5V以下の範囲が1msある場合は、別の揺動ノイズと判断する。 Specified as voltage change time exceeding 2.5V in code ON area. Noise, located between chatterings t <sub>1</sub> and t <sub>3</sub> , with ON time of 5ms or more apart from both to be regarded as a bounce, t <sub>2</sub> . When there is an ON time, below 2.5V, of 1ms or more in bounce t <sub>2</sub> area, the bounce to be regarded as individual ones.	t <sub>2</sub> ≤ 2ms
3)	揺動ノイズ Sliding noise	コードOFFの部分の電圧変動 The voltage change in code-OFF area.	2.5V以上 2.5V MIN

 <b>ALPS ELECTRIC CO., LTD.</b>				
APPD.	CHKD.	DSGD.	TITLE	
1-26	1-26	1-26	ROTATIONAL ENCODER 9形回転形エンコーダ	
00/01/14	00/01/14	Y. KANZAKI	DOCUMENT NO.	
△ <sub>1</sub>	2002-06-24	H. K	H. H	H. M
SYMB	DATE	APPD	CHKD	DSGD
		K. ITO	H. SHIMOMURA	'00/1/06
5LA209-1 (2/6)				

CLASS No.	TITLE 回転形エンコーダ 規格書 ROTATIONAL ENCODER SPECIFICATION	(SW01)
-----------	---	--------

項目 Item	条件 Conditions	規格 Specifications
4-4 位相差 Phase-difference	<p>360°・s<sup>-1</sup>の定速にて操作軸を回転する。 Measurement shall be made under the condition which the shaft is rotated in 360°・s<sup>-1</sup> (constant speed).</p> <p>&lt;fig. 4&gt;</p> <p>注意事項：摺動接点ですので手動操作時の出力波形はご使用されるツマミ径、軸の回転速度によって変化致します。回路設計時は実装にて確認願います。 Note: Above specification (4-4) is changeable. When operate by manual. Please check performance using actual circuit and knob.</p>	<fig. 4>において In<fig. 4> ΔT ≥ 5ms
4-5 絶縁抵抗 Insulation resistance	端子-軸受間にD. C. 250V印加する。 Measurement shall be made under the condition which a voltage of 250V D.C. is applied between individual terminals and bushing.	端子-軸受間にて100MΩ以上 Between individual terminals and bushing: 100MΩ MIN.
4-6 耐電圧 Dielectric strength	端子-軸受間にA. C. 300V1分間又は、A. C. 360V1秒間印加する。 (リーク電流1mA) A voltage of 300V A.C. shall be applied for 1min or a voltage of 360V A.C. shall be applied for 1s between individual terminals and bushing. (Leak current: 1mA)	損傷・アーク・絶縁破壊がないこと。 Without damage to parts, arcing or breakdown.

5. 機械的性能 Mechanical characteristics

項目 Item	条件 Conditions	規格 Specifications
5-1 全回転角度 Total rotational angle		360° (エンドレス) 360° (Endless)
5-2 クリックトルク Detent torque	(クリック付きのみ適用) (Applied for with-detent type)	8 ± 5mN・m
回転トルク Rotational torque	(クリックなしのみ適用) (Applied for without-detent type)	
5-3 クリック点数及び位置 Number and position of detents.	(クリック付きのみ適用) (Applied for with-detent type)	30点クリック 30 detents (ステップ角度 12° ± 3°) (Step angle: 12° ± 3°)
5-4 端子強度 Terminal strength	端子先端の任意の方向に5Nの力を1分間加える。 A static load of 5N be applied to the tip of terminals for 1min in any direction.	端子の破損、著しい力タがないこと。 但し、端子の曲がりは可とする。 Without damage or excessive looseness of terminals. Terminal bend is permitted.

<b>ALPS ALPS ELECTRIC CO., LTD.</b>				
APPD.	CHKD.	DSGD.	TITLE	
1-2G	1-2G	1-2G	9形回転形エンコーダ 9mm SIZE ROTATIONAL ENCODER	
00/01/14	00/01/14	Y. KANZAKI	DOCUMENT NO	
SYMB	DATE	APPD	CHKD	DSGD
△1	00/7/28	K. I	S. M Y. K	K. ITO
			5LA209-1 (3/6)	

CLASS No.	TITLE 回転形エンコーダ 規格書 ROTATIONAL ENCODER SPECIFICATION	(SW01)
-----------	---	--------

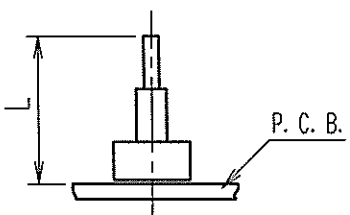
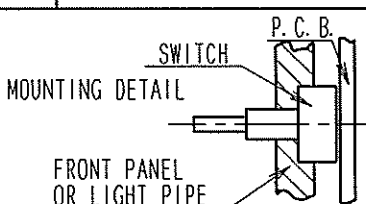
項目 Item	条件 Conditions	規格 Specifications
5-5 軸の押し引き強度 Push-pull strength of shaft	軸の押し及び引き方向に100Nの力を10秒間加える。 (セット実装状態) Push and pull static load of 100N shall be applied to the shaft in the axial direction for 10s. (After installing)	軸の破損、著しいガタのないこと。 感度に異常がないこと。 Without damage or excessive play in shaft. No excessive abnormality in rotational feeling.
5-6 △ 軸ガタ Shaft wobble	軸先端から5mmの位置に50mN・mの曲げモーメントを加える。 A momentary load of 50mN・m shall be applied at the point 5mm from the tip of the shaft in a direction perpendicular to the axis of shaft. 	軸受長 軸ガタ Bushing length Wobble length (mm) (mm-p less) 5 0.8xL/30 → 7 0.5xL/30 Lは取付長さで比例計算する。 L: Measurement point from mounting surface of bushing
5-7 軸のスラスト方向ガタ Shaft play in axial direction		0.4mm 以下 0.4mm MAX.
5-8 軸の回転方向ガタ Rotation play at the click position	→ (クリック付きのみ適用) (Applied for with-delent type) 角度板にて測定する。 Measure with jig for rotational angle.	4° 以内 4° MAX.
5-9 △ △ 軸の横押し強度 Shaft side pressure strength	取付面より30mmの位置に2N・mの曲げモーメントを10秒加える。 軸長が30mmに満たない場合は下記の式による。Lは取付面からの軸先端までの高さとする。 2N・m/L=軸に加える力。 Bending moment of 2N・m to be applied to the shaft for 10 seconds at 30mm from the mounting surface. If the shaft length is less than 30mm, the value shall be calculated as below formula. L: Measurement point from mounting surface. 2N・m/L=shaft applied force.	軸の破損、本体破損のないこと。 Without damage of shaft or product.
5-10 取付け上の注意 Notice for mounting	右図の様にスイッチ本体を抑えてご使用下さい。セット側でスイッチ本体の引き及び回転方向の「カイト」が無い場合は、はんだ付けだけの固定となり、はんだ付け信頼性及びスイッチ本体強度が不安定となる可能性があります。 Hold the bushing use front panel or light pipe. Because this switch not has thread. If don't hold the bushing, the switch maybe become intermittent rough mounting after soldering by knob stopper face.	

					<b>ALPS ALPS ELECTRIC CO., LTD.</b>			
△	1	00/10/3	K.	S. M. Y. K.	APPD.	CHKD.	DSGD.	TITLE
△	1	00/7/24	K.	S. M. Y. K.	1-2G	1-2G	1-2G	9形回転形エンコーダ
△	1	00/5/24	K.	S. M. Y. K.	00/01/14	00/01/14	99/12/27	9mmSIZE ROTATIONAL ENCODER
SYMB	DATE	APPD	CHKD	DSGD	K. ITO	H. SHIMOMURA	Y. KANZAKI	DOCUMENT NO.
								5LA209-1 (4/6)

CLASS No.	TITLE 回転形エンコーダ 規格書 ROTATIONAL ENCODER SPECIFICATION	(SW01)
-----------	---	--------

6. 耐久性能 Endurance characteristics.

項目 Item	条件 Conditions	規格 Specifications
6-1 寿命性能 Rotational life	無負荷で軸を毎時500サイクルの速さで、15,000サイクル連続動作を行う。 但し、試験途中5,000で中間測定を行う。(1サイクルは、360°1往復) The shaft of encoder shall be rotated to 15,000 cycles at a speed of 500cycles per hour without electrical load, after which measurements shall be made. However, an interim measurement shall be made immediately after 5,000 cycles. (1 cycle: rotate 360° CCW rotate 360° CW)	位相差 $t \geq 5mS$ Phase difference $t \geq 5mS$ バウンス $t \leq 5mS$ Bounce $t \leq 5mS$ クリック又は回転トルクは 初期規格値に対し $\pm 30\%$ 以内のこと Detent or Rotational torque:Relative to the previously specified value. $\pm 30\%$ MAX その他初期規格を満足すること。 4. 1~4. 3, 4. 5~4. 6, 5. 1, 5. 3 Specifications in clause 4. 1~4. 3, 4. 5~4. 6, 5. 1, 5. 3 shall be satisfied.
6-2 耐湿性 Damp heat	温度 $60 \pm 2^\circ C$ 、湿度90~95%の恒温湿槽中に $240 \pm 10$ 時間放置後、常温、常湿中に1.5時間放置する。 The encoder shall be stored at a temperature of $60 \pm 2^\circ C$ with relative humidity of 90% to 95% for for $240 \pm 10h$ in a thermostatic chamber. And then the encoder shall be subjected to standard atmospheric conditions for 1.5h, after which measurement shall be made.	
6-3 耐熱特性 Dry heat	温度 $85 \pm 3^\circ C$ の恒温槽中に $240 \pm 10$ 時間放置後、常温、常湿中に1.5時間放置する。 The encoder shall be stored at a temperature of $85 \pm 3^\circ C$ for $240 \pm 10h$ in a thermostatic chamber. And then the encoder shall be subjected to standard atmospheric conditions for 1.5h, after which measurements shall be made.	クリック又は回転トルク 初期規格値に対し $\pm 30\%$ 以内のこと Detent or Rotational torque:Relative to the previously specified value. $\pm 30\%$ MAX
6-4 低温特性 Cold	温度 $-40 \pm 3^\circ C$ の恒温槽中に $240 \pm 10$ 時間放置後、常温、常湿中に1.5時間放置する。 The encoder shall be stored at a temperature of $-40 \pm 3^\circ C$ for $240 \pm 10h$ in a thermostatic chamber. And then the encoder shall be subjected to standard atmospheric conditions for 1.5h, after which measurement shall be made.	その他初期規格を満足すること。 4. 1~4. 6, 5. 1, 5. 3 Specifications in clause 4. 1~4. 6, 5. 1, 5. 3 shall be satisfied.
6-5 耐振性 Vibration	10~55~10Hzと変化する振動(1周期1分/振幅1.5mm)をX, Y, Z, 各方向に2時間加える。 The following vibration shall be applied to the encoder, after which measurement shall be made: The entire frequency range, from 10Hz to 55Hz and return to 10Hz, shall be transversed in 1 min. Amplitude (total excursion): 1.5mm. This motion shall be applied for a period of 2h in each of 3 mutually perpendicular axes. (A total of 6h)	
6-6 耐落下性 Free falling	60cmの高さより製品の任意の方向からビニタイルを張ったコンクリートの床上に自由に落下させる。 The encoder shall be fallen freely at any posture from 60cm height to the concrete floor covered with vinyl-tile, after which measurement shall be made.	初期規格を満足すること。 4. 1~4. 6, 5. 1~5. 8 Specifications in clause 4. 1~4. 6, 5. 1~5. 8 shall be satisfied. (但し、端子部の変形は除く。) (Except the deformation of terminals)

					 <b>ALPS ELECTRIC CO., LTD.</b>		
APPD.	CHKD.	DSGD.	TITLE			9形回転形エンコーダ	
1-2G	1-2G	1-2G	9mmSIZE ROTATIONAL ENCODER			DOCUMENT NO.	
00/01/14	00/01/14	99/12/27	5LA209-1			(5/6)	
SYMB	DATE	APPD	CHKD	DSGD	K. ITO	H. SHIMOMURA	Y. KANZAKI

その他、取扱い上のご注意 PRECAUTIONS IN USE

- 1) 保管は高温、多湿の場所及び腐食性ガス中を避けて下さい。  
During operation, storage in high temperature and humidity, and in corrosive gas, should be avoided
- 2) エンコーダのハルスカウント処理の設計においては動作スピード、サンプリングタイム、マスキングタイム等に注意し、実装確認の上御使用願います。  
In case of pulse count process design, operational speed, sampling time, and masking time etc should be taken into the consideration.  
Please check above matter at first on your circuit for the secure reason.
- 3) エンコーダのハルスカウント処理の回路は下図のフィルターをいれることを推奨します。  
For your pulse count design, it should be considered to add C/R filter on your circuit shown as below.

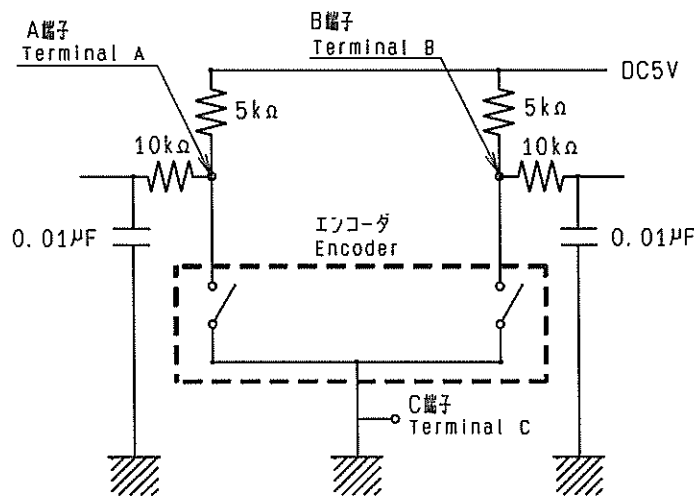

- 4) 本製品の本体に直接水分がかかると、ハルス波形に異常が発生する可能性がありますので、製品に直接水分がかからないよう配慮願います。  
Care must be taken not to expose this product to water or dew to prevent possible problem in pluse output wave form.
- ⚠ 5) 本製品はオーディオ機器、映像機器、家電機器、情報機器、通信機器などの一般電子機器用に設計、製造したものです。生命維持装置、宇宙航空機器、防災防犯機器などの高度な安全性や信頼性が求められる用途に使用される場合は、貴社にて適合性の確認を頂くか、当社へご確認ください。  
This product has been designed and manufactured for general electronic devices, such as audio devices, visual devices, home electronics, information devices and communication devices.  
In case this product is used for more sophisticated equipment requiring higher safety and reliability, such as life support system, space & aviation devices, disaster prevention & security system, please make verification of comformity or check on us for the details.

					<b>ALPS ALPS ELECTRIC CO., LTD.</b>			
					APPD.	CHKD.	DSGD.	TITLE
					1-DSG2	1-DSG2	1-DSG2	ROTATIONAL ENCODER
								回転形エンコーダ
					K. ITO	H. SHIMOMURA	Y. KANZAKI	DOCUMENT NO.
					'00/4/06	'00/4/06	'00/4/06	5LA209-1 (6/6)
SYMB	DATE	APPD	CHKD	DSGD				
1	00/5/24	K. I	S. M Y K					

CLASS No.	TITLE プッシュモーメンタリスイッチ規格書 PUSH MOMENTARY SWITCH SPECIFICATION	(SW02)
-----------	---	--------

1. 定格容量 (抵抗負荷)  
Switch rating (Resistor load) D. C. 5V 10mA 抵抗負荷 (最大定格) Resistive load (Maximum rating)  
1mA 抵抗負荷 (最小定格) Resistive load (Minimum rating)

2. 電気的性能 Electrical characteristics

項目 Item	条件 Conditions	規格 Specifications
2-1 接触抵抗 Contact resistance	D. C. 5V 1mA 電圧降下法にて測定する。 Measured by the 1mA 5V D. C. voltage drop method.	100mΩ MAX.
2-2 チャタリング Chattering	1サイクル (OFF-ON-OFF) 1秒で動作させる。 Switch is operated at the rate of 1 cycle 1s. The 1 cycle shall be OFF-ON-OFF.	10ms以下 Less than 10ms
2-3 絶縁抵抗 Insulation resistance	端子-軸受間にD. C. 250V印加する。 Measurement shall be made under the condition which a voltage of 250V D. C. is applied between individual terminals and bushing.	端子-軸受間にて100MΩ以上 Between individual terminals and bushing: 100MΩ MIN.
2-4 耐電圧 Dielectric strength	端子-軸受間にてA. C. 300V 1分間又は、A. C. 360V 1秒間印加する。 (リーク電流1mA) A voltage of 300V A. C. shall be applied for 1min or a voltage of 360V A. C. shall be applied for 1s between individual terminals and bushing. (Leak current: 1mA)	損傷・アーク・絶縁破壊がないこと。 Without damage to parts, arcing or breakdown.

注記: 軸・スイッチ端子間は絶縁されております。  
Note: Shaft is insulated from switch terminal.

3. 機械的性能 Mechanical characteristics

項目 Item	条件 Conditions	規格 Specifications
3-1 スイッチ回路・接点数 Contact arrangement		単極単投 (Push on) S. P. S. T. (Push on)
3-2 スイッチ移動量 Switching stroke		0.5 ± 0.3 mm
3-3 スイッチ作動力 Switch operation force		6 ± 2.5 N

4. 耐久性能 Endurance characteristics.

項目 Item	条件 Conditions	規格 Specifications
4-1 動作寿命特性 Operating life	無負荷にて軸を毎時500回の速で10,000回連続動作を行う。 但し、試験途中5,000で中間測定を行う。押し圧: 10N以下 The shaft of switch shall be 10,000 times at a speed of 500 times per hour without electrical load, after which measurements shall be made. However, an interim measurement shall be made immediately after 5,000 times. Push force: 10N MAX.	接触抵抗: 200mΩ以下 その他、初期規格を満足すること。 Switch contact resistance: 200mΩ MAX. Except above items, specifications in clause 2.2~4. and 3.1~3 shall be satisfied.

5. その他 Note

- 5-1 軸にツマミを取り付け、センターから10mmの位置で押し込んだ時に引っ掛かり感の無いこと。  
No sticky feel shall be observed when the knob on the shaft is pushed at 10mm off the center.

6. 注意事項 Note

- 6-1 プッシュスイッチ付きのエンコーダは、軸が押されたままの状態では梱包や保管をされず、スイッチ部に支障をきたす恐れがありますのでご注意ください。  
Encoder equipped with a push-on switches are packaged or stored with their shafts being pushed-in, the switch part may be out of order and pay attention when you package or store them.

					 <b>ALPS ELECTRIC CO., LTD.</b>	
		APPD.	CHKD.	DSGD.	TITLE プッシュモーメンタリスイッチ PUSH MOMENTARY SWITCH	
		1-2G	1-2G	1-2G	DOCUMENT NO.	
		2000/11/6	2000/11/6	2000/11/6	5LA2094-3 (1/1)	
SYMB	DATE	APPD	CHKD	DSGD	K. ITO	S. MIZBUCHI Y. KANZAKI

はんだ耐熱性 Soldering conditions

項目 Item	条件 Conditions	規格 Specifications
1 はんだ耐熱 Resistance to soldering heat	下記の“はんだ付け条件”による。 Specified by "Soldering conditions" shown as below.	はんだ付け後、電気的性能を満足すること。また、著しいガタ等機械的に異常のないこと。 Electrical characteristics shall No mechanical abnormality such as a excessive play.

はんだ付け条件 Soldering conditions

1) 手はんだの場合 Manual soldering

▲ 温度350°C以下、時間3秒以内

▲ Bit temperature of soldering iron : 350°C or less.

Application time of soldering iron : within 3s.

2) ティップはんだの場合 Dip soldering

使用基板 : t1. 6両面銅張積層板

Printed wiring board: Both-sided copper clad laminate board with thickness of 1.6mm.

フラックス : 比重0.82以上のフラックスを用い発泡式フラクサーにて発泡面高さは、基板板厚の半分を目安とし、かつ基板表面にフラックスの流入がないこと。

FLUX:

• Specific gravity: 0.82 or more.

• Flux shall be applied to the board using a bubble foaming type fluxer.

• The board shall be soaked in the flux bubble only to the middle of its thickness.

• Flux shall not come into contact with the component side surface.

プリヒート : 基板表面温度100°C以下、時間2分以内

Preheating: • Surface temperature of board: 100°C or less. • Preheating time: within 2 min.

はんだ : 温度260°C±5°C、時間5秒±1秒以内

Soldering: • Solder temperature: 260°C ±5°C. • Immersion time: Within 5±1s

以上の工程を1回または2回通過する。

Apply the above soldering process for 1 or 2 times.

はんだ付け時のご注意事項 Note for soldering method.

1) 下図のようにP. C. B. の上面にはんだ付けをする配線は、お避けください。  
Please avoid soldering on upper surface (the component side surface) of the PC board as shown below.

2) 本製品の下面にパターンを形成する場合はご注意ください。  
(取付板のカシメ部と基板面が極めて近いため)

《下図ハッチング部ハターンの引き出し注意範囲》挿入側からみた図

If there is electrical circuit pattern under this product, the pattern have to be properly protected with insulated material. Because the gap between PCB and bended portion of frame is very small. Viewed from mounting side

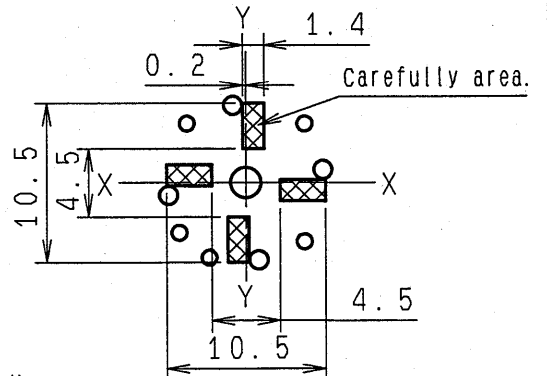
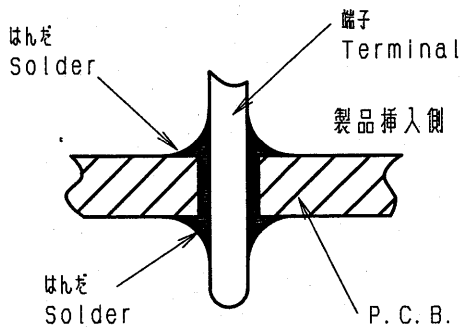

2) 半田ティップ後の洗浄についてはエンコータ一内にフラックスが流入する場合があります。挿入側より見た図  
接触不良の原因となりますのでご注意ください。

VIEWED FROM MOUNTING SIDE

Please avoid cleaning of PCB board because the flux used during the dip soldering process may enter the encoder and cause poor contact

**ALPS ALPS ELECTRIC CO., LTD.**

APPD.	CHKD.	DSGD.	TITLE
1-DSG2	1-DSG2	1-DSG2	ROTATIONAL ENCODER
'00/6/01	'00/6/01	'00/6/01	回転形エンコーダ
SYMB	DATE	APPD	DOCUMENT NO.
▲ 2	040220	S. M. H. H. Y. F.	L-E9 (1/1)
K. ITO	S. MI ZOBUCHI	Y. KANZAKI	

OR



注記 軸受材質：亜鉛タ\*イキャスト  
軸材質：アルミニウム

NOTES BUSHING MATERIAL: ZINC ALLOY DIE CASTING  
SHAFT MATERIAL: ALUMINUM

(SW01) ENCODER  
(SW02) PUSH ON SW

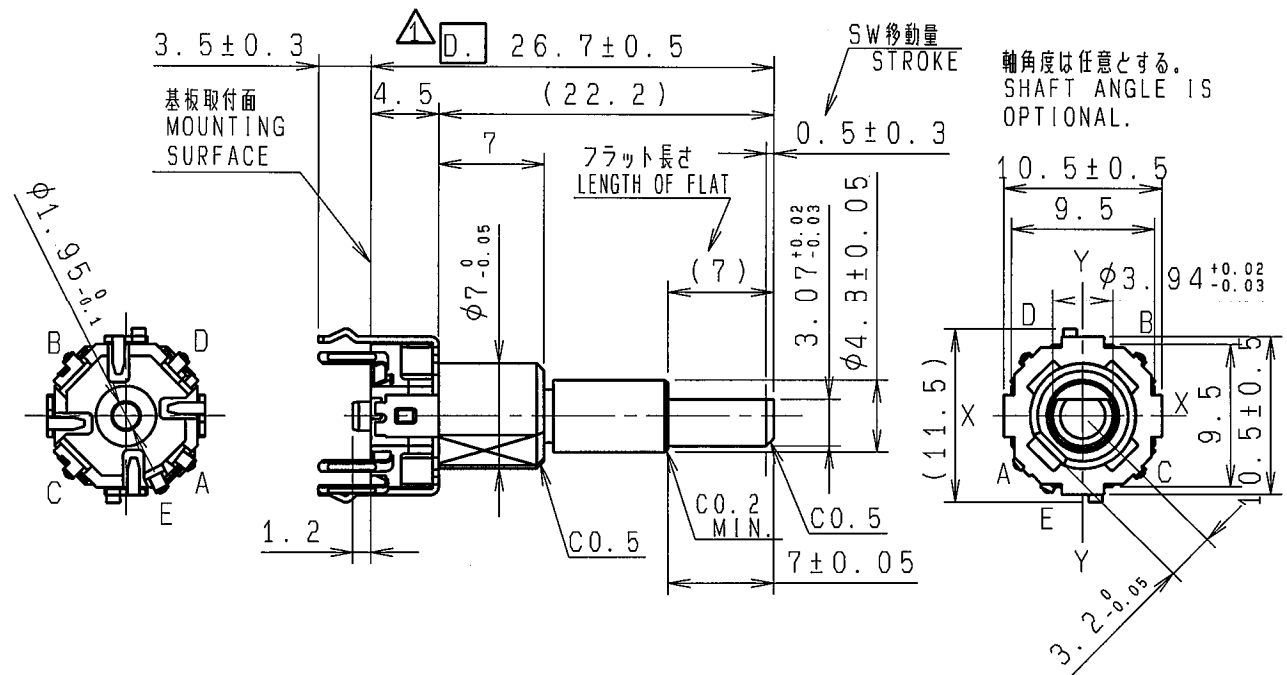

軸角度は任意とする。  
SHAFT ANGLE IS  
OPTIONAL.

取付穴寸法図(挿入側から見た図)許容差±0.1  
P.W.B. MOUNTING DETAIL  
(VIEWED FROM MOUNTING SIDE)  
TOLERANCE ±0.1

スナップ部詳細(3:1)  
RETENTION FEATURE DETAIL

基板挿入部端子形状詳細(3:1)  
TERMINAL DETAIL

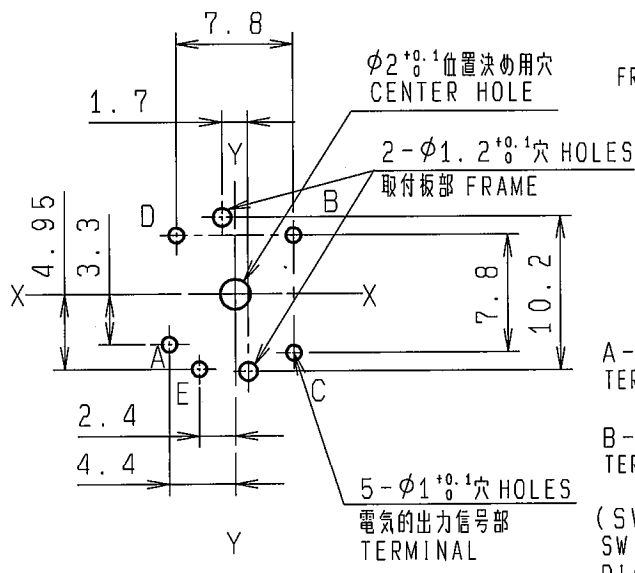
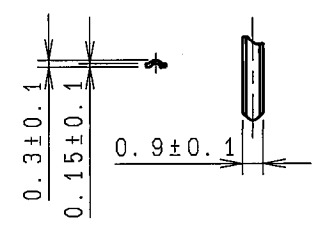
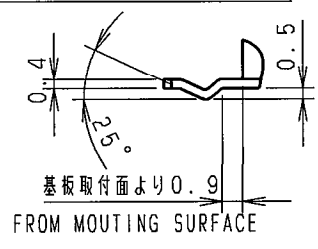

(SW01) 出力信号  
ENCODER OUTPUT SIGNAL

時計方向回転  
C.W. ROTATION

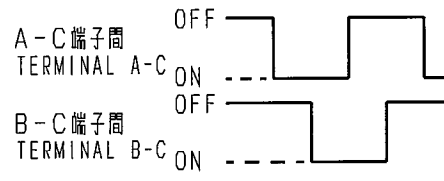

(SW02) 回路図  
SWITCH CIRCUIT  
DIAGRAM

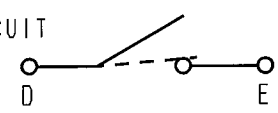

指定なき部分の許容差 TOLERANCES UNLESS OTHERWISE SPEC	
L ≤ 4	±0.2
4 < L ≤ 16	±0.3
16 < L ≤ 63	±0.4
63 < L ≤ 250	±0.5
250 < L	±0.7
角度 ANGULAR DIMENSION	±5°

基板板厚 t=1.6mm  
P.C.B. THICKNESS t=1.6mm

PART NO.	MATERIAL	SPEC/NAME	FINISH	30C/15P
----------	----------	-----------	--------	---------

					<b>ALPS ELECTRIC CO., LTD.</b>			
					H. KIMURA	2008-03-12	2:1	
					CHKD.			TITLE
					Kunji Sasaki	2008-03-12		9形1軸 PUSH ON SW付エンコータ*組立図
					APPD.		UNIT	DOCUMENT NO.
					Y. OHYA	2008-06-16	mm	LA209426
NO.	SYMB	DATE	APPD	CHKD	DSGD			

## X-ON Electronics

Largest Supplier of Electrical and Electronic Components

*Click to view similar products for [Coded Rotary Switches](#) category:*

*Click to view products by [ALPS](#) manufacturer:*

Other Similar products are found below :

[PT65503RT](#) [P60A703](#) [RTAP31S12WFLSP](#) [GSER-10](#) [GT-EVA01AA-L1](#) [EC11L1525G01](#) [EC111012000Y](#) [EC28B1550404](#) [EC11E0940501](#)  
[RT004D](#) [EC11E152T40B](#) [EC11J152540Z](#) [EC11E156040J](#) [EC11E156445M](#) [EC09E152440T](#) [EC11E09444A8](#) [EC11E152T408](#)  
[EC10E1220515](#) [EC12E24404A9](#) [EC11G1560418](#) [01-1104](#) [01-1123](#) [01-1234](#) [01-1424](#) [01-1433](#) [07-3153](#) [07-3154](#) [CRD10CM0SBR](#)  
[DRS4116](#) [RTE1600R44](#) [ERD110RSZ](#) [ERD116CSZ](#) [ERD116RFZ](#) [ERD116RSZ](#) [94HCB10T](#) [94HBB16WT](#) [94HBB16RAT](#) [94HBB10WT](#)  
[94HBB10RAT](#) [94HBB08RAT](#) [94HAC10T](#) [94HAB16WT](#) [94HAB16T](#) [94HAB10WT](#) [94HAB10RAT](#) [94HAB08WT](#) [94HAB08RAT](#)  
[ERD216RSZ](#) [P65SMT101](#) [P65SMT103](#)