

EC11

1.1 mm Size Metal Shaft Type

Compact and highly reliable type available in many varieties



Typical Specifications

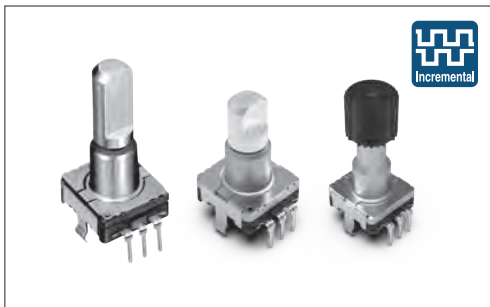

Items	Specifications
Output signal	Two phase of A, B Self-return switch (EC111)
Rating	10mA 5V DC
Operating life	15,000 cycles
Operating temperature range	-40°C to +85°C

Product Line

Structure	Shaft configuration	Length of the shaft (mm)	Torque (mN·m)	Number of detent	Number of pulse	Push-on switch	Travel of push-on switch (mm)	Minimum order unit (pcs.)		Product No.	Drawing No.
								Japan	Export		
Vertical	Flat	20	10±7	30	9	Without	—	1,200	2,400	EC11E09204A4	1
										EC11E15204A3	
										EC11E1820402	
										EC11E09244BS	
			10±7	36	18	With	0.5			EC11E15244G1	2
										EC11E18244AU	
										EC11E09244AQ	
										EC11E15244B2	
		15	10±7	30	15	Without	—	EC11N1520401	3		
								With	0.5	EC11N1524402	4
									1.5	EC11N1525404	4
								With	0.5	EC11N1524403	4
			1.5	EC11N1525405	4						
			Without	—	EC11N1520402	3					
				—	EC11N1524403	4					
			20	10±7	36	18	With	1.5	EC11M1565403	5	
EC11M1575403	6										
Less shaft wobble	Serrated	25	12±7	30	Without	1.5	1,000	2,000	EC1110120005	7	
			8.5±5	Without					EC111012010H		8
Self-return switch	Flat	15	3 to 30	Without	Self-return switch	Without	1,200	2,400	EC1110120201	8	
		20							With		0.5
									1.5		

Note

Other varieties are also available. Please inquire.

Packing Specifications







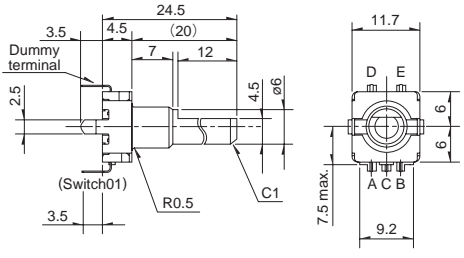
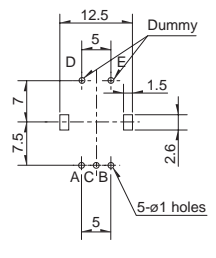

Tray

Product No.	Number of packages (pcs.)		Export package measurements (mm)
	1 case / Japan	1 case / export packing	
EC11E/EC11N	1,200	2,400	540×360×254
EC11M	1,000	2,000	
EC111	1,200	2,400	507×363×216

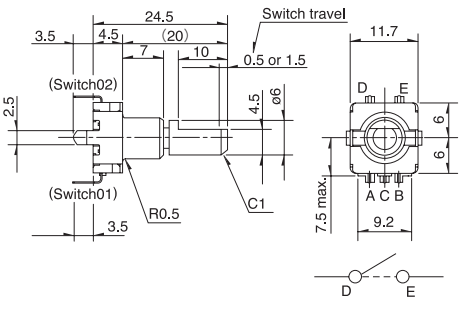
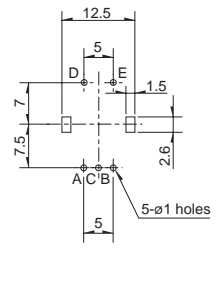
Refer to P.250 for product varieties.
Refer to P.251 for switch specifications.
Refer to P.275 for soldering conditions.

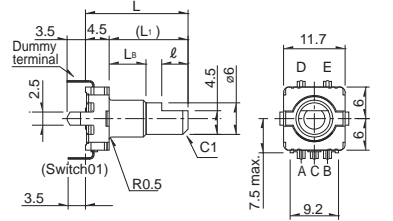
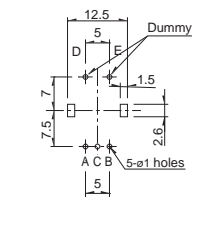
Dimensions

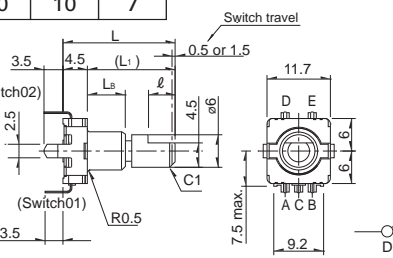
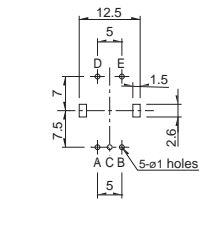
Unit:mm

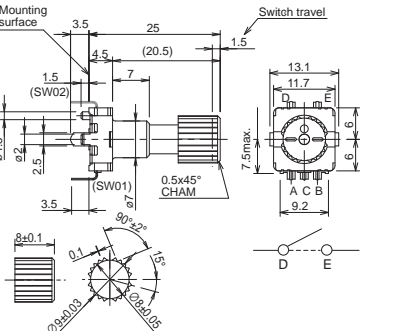
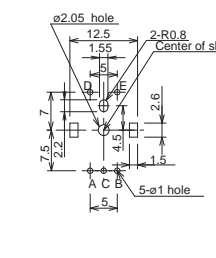



No.	Photo	Style	PC board mounting hole dimensions (Viewed from mounting side)												
1	<p>EC11E Vertical</p> 														
2	<p>EC11E Vertical with push-on switch (travel 0.5mm / 1.5mm)</p> 														
3	<p>EC11N Vertical</p> 	<table border="1" data-bbox="636 1144 904 1230"> <thead> <tr> <th>L</th> <th>L₁</th> <th>L_B</th> <th>ℓ</th> </tr> </thead> <tbody> <tr> <td>19.5</td> <td>15</td> <td>7</td> <td>5</td> </tr> <tr> <td>24.5</td> <td>20</td> <td>10</td> <td>7</td> </tr> </tbody> </table> 	L	L ₁	L _B	ℓ	19.5	15	7	5	24.5	20	10	7	
L	L ₁	L _B	ℓ												
19.5	15	7	5												
24.5	20	10	7												
4	<p>EC11N Vertical with push-on switch (travel 0.5mm / 1.5mm)</p> 	<table border="1" data-bbox="636 1498 904 1583"> <thead> <tr> <th>L</th> <th>L₁</th> <th>L_B</th> <th>ℓ</th> </tr> </thead> <tbody> <tr> <td>19.5</td> <td>15</td> <td>7</td> <td>5</td> </tr> <tr> <td>24.5</td> <td>20</td> <td>10</td> <td>7</td> </tr> </tbody> </table> 	L	L ₁	L _B	ℓ	19.5	15	7	5	24.5	20	10	7	
L	L ₁	L _B	ℓ												
19.5	15	7	5												
24.5	20	10	7												
5	<p>EC11M Vertical with push-on switch (travel 1.5mm)</p> 														

- Encoders
- Metal Shaft
- Insulated Shaft
- Through Shaft Type
- Ring Type

EC11 11mm Size Metal Shaft Type

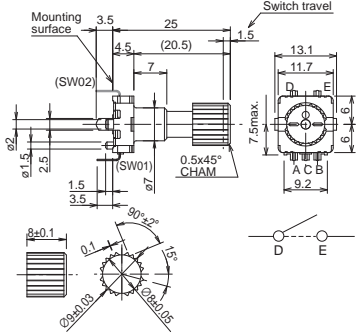
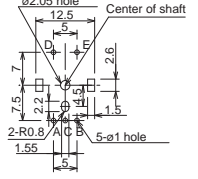
Dimensions

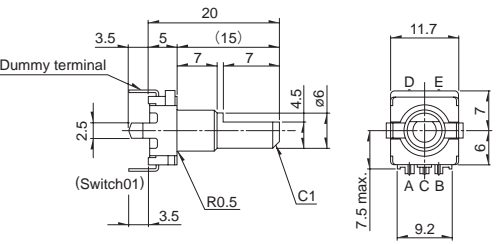
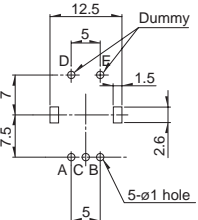
Unit:mm

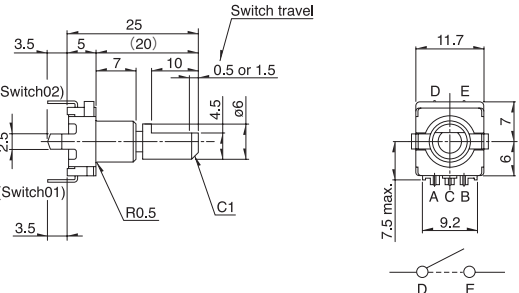
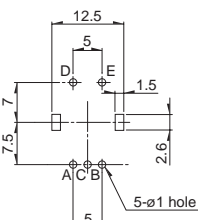
No.	Photo	Style	PC board mounting hole dimensions (Viewed from mounting side)
6	<p>EC11M Vertical with push-on switch (travel 1.5mm)</p> 		
7	<p>EC111 Self-return switch</p> 		
8	<p>EC111 Self-return switch with push-on switch (travel 0.5mm / 1.5mm)</p> 		

Encoders

Metal Shaft

Insulated Shaft

Through Shaft Type

Ring Type

Output Wave

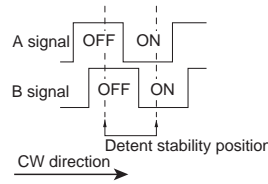
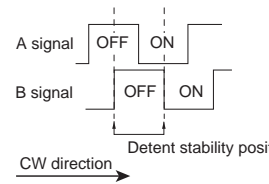
EC11E, EC11N, EC11M	EC11E
<p>EC11E 30 detents, 15 pulse EC11N, EC11M</p> 	<p>Detent stability position cannot be specified for B signal EC11E 18 detents 9 pulse EC11E 36 detents 18 pulse</p> 

Sliding Noise

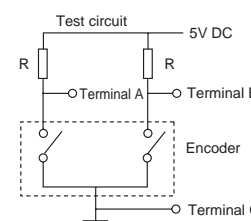

Test circuit

5V DC

R

Terminal A

Terminal B

Encoder

Terminal C

Measurement condition : Rotation speed 360°/s t : Masking time to avoid chattering

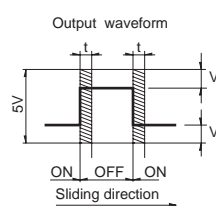

Output waveform

5V

t₁

t₂

V₁

V₂

ON OFF ON

Sliding direction

**EC11E/EC11N/
EC11M**

V₁=V₂=1.5V max.
At R = 5kΩ
Chattering : 3ms max.
Bounce : 2ms max.

Circuit Diagram

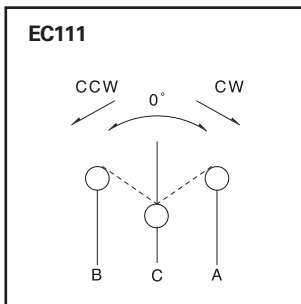

- Encoders
- Metal Shaft
- Insulated Shaft
- Through Shaft Type
- Ring Type

1 1 mm Size Metal Shaft Type / Product Varieties

In addition to the Product Line, we accommodate the following specifications. Combinations not included in the Product Line are treated as semi-standard products.

■ Shaft Dimensions

1. Single-shaft Type

1) Serrated Type

Unit:mm

EC11 (Except EC11M)
Style (Shaft diameter: $\phi 6$)

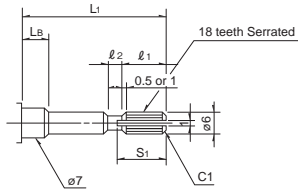

● Detailed dimensions

L_1	L_B	l_1	l_2	S_1
20	7	6	1	7
25	10	10	2	11

EC11M
Style (Shaft diameter: $\phi 9$)

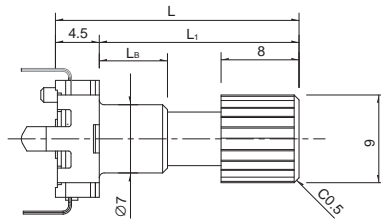

● Detailed dimensions

L	L_1	L_B
18	13.5	5
25	20.5	7
28	23.5	10

2) Flat Type

Unit:mm

EC11
Style (Shaft diameter: $\phi 6$)

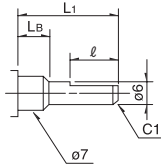

● Detailed dimensions

L_1	L_B	l
15	5	7
15	7	5 (6)
20	7	10 (12)
25	10	12

※1

※1 Does not comply with EC111

Values in parentheses apply to products without push-on switch.

3) Slotted Type

Unit:mm

EC11
Style (Shaft diameter: $\phi 6$)

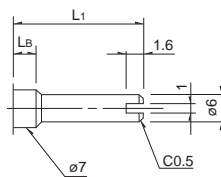

● Detailed dimensions

L_1	L_B
15	7
20	7
25	10

Notes

1. Shaded areas in shaft type details indicate specifications included in the product lineup on P.246
2. Other varieties are also available. Please inquire.

11 mm Size Metal Shaft Type / Switch Specifications

1. EC11E/EC11N/EC111 Series

Switch type		Momentary push switch	
Contact arrangement		Single pole and single throw (Push-on)	
Travel (mm)		0.5±0.3	1.5±0.5
Operating force		6 ^{+2.5} ₋₂ N	4±2N
Operating life		20,000 times	
Electrical performance	Rating	0.1A 5V DC (500μA 5V DC min. ratings)	
	Contact resistance	100mΩ max. for initial period, 200mΩ max. after operating life.	
	Insulation resistance	100MΩ min. 250V DC	
	Voltage proof	300V AC for 1 minute or 360V AC for 2 second	

2. EC11M Series

Switch type		Momentary push switch	
Contact arrangement		Single pole and single throw (Push-on)	
Travel (mm)		1.5±0.35	
Operating force		5±2N	
Operating life		20,000 times	
Electrical performance	Rating	0.15A 5V DC (500μA 5V DC min. ratings)	
	Contact resistance	100mΩ max. for initial period, 200mΩ max. after operating life.	
	Insulation resistance	100MΩ min. 250V DC	
	Voltage proof	300V AC for 1 minute or 360V AC for 2 second	

Encoders

Metal Shaft











Insulated Shaft

Through Shaft Type

Ring Type

Encoders

List of Varieties

Type		Metal shaft										
		9mm size			11mm size							
Series		EC09E		EC11E		EC11N		EC11M		EC111		
Photo												
Output		Incremental (Two phase A and B)								Self-return switch		
Shaft types		Single-shaft										
Control part orientation		Vertical										
Number of pulse / Number of detent		15/30		9/18 15/30 18/36		15/30		15/30 15/without		—		
Features		—		—		—		Less shaft wobble		—		
Dimensions (mm)		W		9.5		11.7						
		D		12						13		
		H		4.5						5		
Operating temperature range		-40°C to +85°C										
Operating life		15,000 cycles										
Automotive use		●		●		●		●		●		
Life cycle (availability)												
Electrical performance		Rating		10mA 5V DC								
		Max./min. operating current (Resistive load)		10mA /1mA								
		Insulation resistance		100MΩ min. 250V DC								
		Voltage proof		300V AC for 1 minute or 360V AC for 1s		300V AC for 1 minute or 360V AC for 2s						
Mechanical performance		Rotational torque (Without detent)		—		—		8.5±5mN·m		3 to 30mN·m		
		Detent torque		8±5mN·m		10±7mN·m				12±7mN·m		—
		Push-pull strength		100N								
Shaft configuration		Flat		Flat, Slotted, Serrated		Flat		Serrated		Flat, Slotted, Serrated		
Terminal type		Insertion										
Switch Specifications		Switch type		Push-on switch								
		Contact arrangement		Single pole and single throw (Push-on)								
		Travel (mm)		0.5±0.3	1.5±0.5	0.5±0.3	1.5±0.5	0.5±0.3	1.5±0.5	1.5±0.35	0.5±0.3	1.5±0.5
		Operating force (N)		6 \pm $\frac{2.5}{2}$	4±2	6 \pm $\frac{2.5}{2}$	4±2	6 \pm $\frac{2.5}{2}$	4±2	5±2	6 \pm $\frac{2.5}{2}$	4±2
		Rating		10mA 5V DC (1mA 5V DC min. ratings)		0.1A 5V DC (500μA 5V DC min. ratings)						
		Contact resistance		100mΩ max. for initial period; 200mΩ max. after operating life.								
		Operating life		10,000 times			20,000 times					
Page		244			246							

Encoders Soldering Conditions 275
 Encoders Cautions 276

Notes

- Indicates applicability to all products in the series.

Encoders / Soldering Conditions

Reference for Manual Soldering

Series	Tip temperature	Soldering time	No. of solders
EC05E, EC09E, EC10E, EC111, EC11E, EC11M, EC11N, EC12D, EC12E, EC18A, EC21A, EC28A, EC35A, EC35AH, EC40A, EC50A, EM11B, EC21C, EC28C, EC35CH	350°C max.	3s max.	1 time

Reference for Dip Soldering

Series	Preheating		Dip soldering		No. of solders
	Soldering surfacetemperature	Heating time	Soldering temperature	Soldering time	
EC09E, EC111, EC11E, EC11M, EC11N, EC18A, EC21A, EC28A, EC35A, EC35AH, EC50A	100°C max.	2 min. max.	260±5°C	5±1s	2 times max.
EM11B	100°C max.	1 min. max.	260°C max.	3s max.	2 times max.
EC10E, EC12D, EC12E	100°C max.	1 min. max.	260±5°C	3±1s	2 times max.
EC40A	110°C max.	1 min. max.	260°C max.	10s max.	1 time

Example of Reflow Soldering Condition

Temperature profile

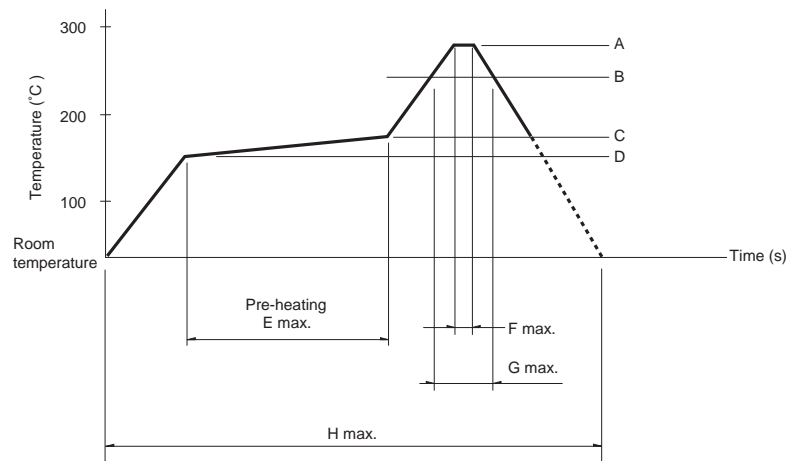

Series	A	B	C	D	E	F	G	H	No. of reflows
EC05E	250°C min.	230°C min.	180°C	150°C	60s to 120s	—	30s to 40s	—	2 times max.
EC21C	230°C to 245°C	220°C	200°C	150°C	60s to 120s	—	25s to 60s	300s max.	1 time max.
EC28C, EC35CH	260°C	230°C	180°C	150°C	2 min. min.	3s	40s	230s max.	1 time max.

Notes

1. When using an infrared reflow oven, solder may sometimes not be applied. Be sure to use a hot air reflow oven or a type that uses infrared rays in combination with hot air.
2. The temperatures given above are the maximum temperatures at the terminals of the encoder when employing a hot air reflow method. The temperature of the PC board and the surface temperature of the encoder may vary greatly depending on the PC board material, its size and thickness. Ensure that the surface temperature of the encoder does not rise to 250°C or greater.
3. Conditions vary to some extent depending on the type of reflow bath used. Be sure to give due consideration to this prior to use.

X-ON Electronics

Largest Supplier of Electrical and Electronic Components

Click to view similar products for [Encoders](#) category:

Click to view products by [ALPS](#) manufacturer:

Other Similar products are found below :

[6-1393048-0](#) [6-1393048-5](#) [62B22-LP-030C](#) [63K25](#) [63K32](#) [63KS100](#) [63KS64](#) [63R100](#) [63R50-020](#) [63RS256-060](#) [700-09-36](#) [RE12D300-201-1](#) [1393047-3](#) [T101-5C2-111-M1](#) [T101-5C3-111-M1](#) [T101-5C4-111-M1](#) [385001M0439](#) [385001M0216](#) [V23401T8002B802](#) [E69-1E69DF10](#) [E69-FCA](#) [62B11-LP-100S](#) [62N11-P](#) [62S22-H9-120S](#) [62S30-L0-200C](#) [62V15-02-080S](#) [63K64](#) [63KS100-040](#) [63R64-050](#) [63RS64700-16-16](#) [V23401D3002B301](#) [3-1393048-1](#) [63KS128](#) [1-1879391-5](#) [GH65C11-N-SO](#) [62S15-M0-P](#) [63R64](#) [1393047-1](#) [E69-FCA02](#) [E69-FCA04](#) [E69-DF20](#) [E69-DF2](#) [63R50](#) [62F01-02-060S](#) [63RS50](#) [62B22-SPP-040S](#) [62B22-SPP-P](#) [62C1122-01-P](#)