

CLASS No.	TITLE 回転形エンコーダ' 規格書 ROTATIONAL ENCODER SPECIFICATION	EC11E09244C3 (SW01)
-----------	--	------------------------

1. 一般事項 General

1-1 適用範囲 Scope

この仕様書は主として電子機器に用いる微小電流回路用11形薄形ロータリーエンコーダに適用する。
This specification applies to 11mm size low-profile rotary encoder (incremental type) for microscopic current circuits, used in electronic equipment.

1-2 標準状態 Standard atmospheric conditions

試験及び測定は特に指定のない限り、次の状態で行う。
Unless otherwise specified, the standard range of atmospheric conditions for making measurements and tests is as follows:

温度 Ambient temperature : 15°C to 35°C
 相対湿度 Relative humidity : 25% to 85%
 気圧 Air pressure : 86kPa to 106kPa

但し、疑義を生じた場合は、次の基準状態で行う。

If there is any doubt about the results, measurements shall be made within the following limits:

温度 Ambient temperature : 20 ± 1°C
 相対湿度 Relative humidity : 63% to 67%
 気圧 Air pressure : 86kPa to 106kPa

1-3 使用温度範囲

Operating temperature range : -40°C to +85°C

1-4 保存温度範囲

Storage temperature range : -40°C to +85°C

2. 構造 Construction

2-1 寸法 Dimensions

添付組立図による。
Refer to attached drawing.

3. 定格 Rating

3-1 定格容量 Rating : D.C. 5V 10mA (1mA MIN)

4. 電気的性能 Electrical characteristics

項目 Item	条件 Conditions	規格 Specifications													
4-1 出力信号 Output signal format	(クリック付きの場合に適用) (Applied for with-detent type) 注意事項: ハ' ルス出力は2クリックで1ハ' ルス出力となっております。又、クリック位置にてA-C端子出力がON、又はOFFとなっており、B-C端子出力のクリック位置での規定はしてありません。 Note: Output signal is 1 pulse per 2 detents. And terminal A-C is pulse ON or OFF at detent position. No specified output of terminal B-C at detent position. <Fig 1>	A, B 2信号の位相差出力とし、詳細は<fig. 1>の通りとする。 (破線はクリック付きの場合のクリックの位置を示す。) 2 Phase-different signals (Signal A, signal B) Details shown in <fig. 1>. (The broken line shows detent position of with-detent type.)													
	<table border="1"> <thead> <tr> <th>軸回転方向 Shaft rotational direction</th> <th>信号 Signal</th> <th>出力波形 Output</th> </tr> </thead> <tbody> <tr> <td rowspan="2">時計方向 C. W.</td> <td>A (A-C端子間) A (Terminal A-C)</td> <td></td> </tr> <tr> <td>B (B-C端子間) B (Terminal B-C)</td> <td></td> </tr> <tr> <td rowspan="2">反時計方向 C. C. W.</td> <td>A (A-C端子間) A (Terminal A-C)</td> <td></td> </tr> <tr> <td>B (B-C端子間) B (Terminal B-C)</td> <td></td> </tr> </tbody> </table>	軸回転方向 Shaft rotational direction	信号 Signal	出力波形 Output	時計方向 C. W.	A (A-C端子間) A (Terminal A-C)		B (B-C端子間) B (Terminal B-C)		反時計方向 C. C. W.	A (A-C端子間) A (Terminal A-C)		B (B-C端子間) B (Terminal B-C)		
軸回転方向 Shaft rotational direction	信号 Signal	出力波形 Output													
時計方向 C. W.	A (A-C端子間) A (Terminal A-C)														
	B (B-C端子間) B (Terminal B-C)														
反時計方向 C. C. W.	A (A-C端子間) A (Terminal A-C)														
	B (B-C端子間) B (Terminal B-C)														

ALPSALPINE CO., LTD.

APPD.	CHKD.	DSGD.	TITLE
C-ENG2	C-ENG2	C-ENG2	回転形エンコーダ ROTATIONAL ENCODER
S.URUSHIHARA	K. SAIJO	K. SATO	DOCUMENT NO.
2019-05-24	2019-05-24	2019-05-24	5LA211-E1 (1/4)
ORG	DATE	APPD	CHKD
1999-10-7	K, I	S, M	H, M
SYMB	DATE	APPD	CHKD

CLASS No.	TITLE 回転形エンコーダ 規格書 ROTATIONAL ENCODER SPECIFICATION	(SW01)
-----------	---	--------

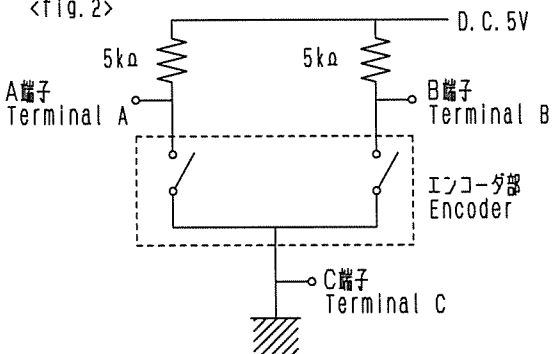
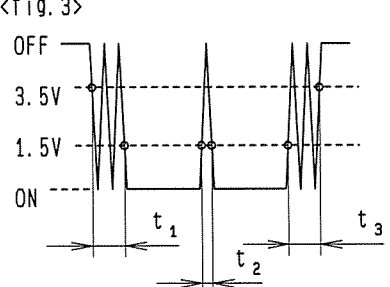
項目 Item	条件 Conditions	規格 Specifications
4-2 分解能 Resolution	1回転にて出力されるパルス数 Number of pulses in 360° rotation.	各相 9パルス/360° 9 pulses/360° for each phase → (クリック付きの場合に適用) (Applied for with-detent type) (2クリック 1パルス) (2click 1pulse)
4-3 スイッチング特性 Switching characteristics	下記測定回路<fig. 2>を用い、回転軸を $360^\circ \cdot s^{-1}$ の速さで回転し測定する。 Measurement shall be made under the condition as follows. 1) Shaft rotational speed : $360^\circ \cdot s^{-1}$ 2) Test circuit : <fig. 2> <fig. 2>  <fig. 3>  (注記) コードOFF状態 : 出力電圧が3.5V以上の状態を言う。 コードON状態 : 出力電圧が1.5V以下の状態を言う。 (note) Code-OFF area : The area which the voltage is 3.5V or more. code-ON area : The area which the voltage is 1.5V or less.	
1) チャタリング Chattering	コードのOFF→ON及びON→OFFの際の、出力1.5V~3.5Vの通過時間にて規定する Specified by the signal's passage time from 3.5V to 1.5V or from 1.5V to 3.5V of each switching position (code OFF→ON or ON→OFF).	$t_1, t_3 \leq 3ms$
2) 摺動ノイズ (バウンス) Sliding noise (Bounce)	コードONの部分の1.5V以上の電圧変動時間とし、チャタリング t_1, t_3 両者との間に1ms以上の1.5V以下のON部分を有するものとする。また、摺動ノイズ間に1.5V以下の範囲が1msある場合は、別の摺動ノイズと判断する。 Specified by the time of voltage change exceed 1.5V in code-ON area. When the bounce has code-ON time less than 1ms between chatterings (t_1 or t_3), the voltage change shall be regarded as a part of chattering. When the code-ON time between 2 bounces is less than 1ms, they are regarded as 1 linked bounce.	$t_2 \leq 2ms$
3) 摺動ノイズ Sliding noise	コードOFFの部分の電圧変動 The voltage change in code-OFF area.	3.5V以上 3.5V MIN

ALPSALPINE CO., LTD.

APPD.	CHKD.	DSGD.	TITLE
C-ENG2	C-ENG2	C-ENG2	回転形エンコーダ ROTATIONAL ENCODER
S. URUSHIHARA	K. SAIJO	K. SATO	DOCUMENT NO.
2019-05-24	2019-05-24	2019-05-24	5LA211-E1 (2/4)
ORG	DATE	APPD	CHKD
1999-10-7	K, I	S, M	H, M
SYMB	DATE	APPD	CHKD

CLASS No.	TITLE 回転形エンコーダ 規格書 ROTATIONAL ENCODER SPECIFICATION	(SW01)
-----------	---	--------

項目 Item	条件 Conditions	規格 Specifications
4-4 位相差 Phase-difference	<p>$360^\circ \cdot s^{-1}$の定速にて操作軸を回転する。 Measurement shall be made under the condition which the shaft is rotated in $360^\circ \cdot s^{-1}$ (constant speed).</p> <p><fig. 4></p> <p>注意事項：搭動接点ですのて手動操作時の出力波形はご使用されるツマミ径、軸の回転速度によって変化致します。回路設計時は実装にて確認願います。 Note: Above specification (4-4) is changeable. When operate by manual. Please check performance using actual circuit and knob.</p>	<p><fig. 4>において $\Delta T \geq 6ms$ In <fig. 4></p>
4-5 絶縁抵抗 Insulation resistance	<p>端子-軸受間にD. C. 250V印加する。 Measurement shall be made under the condition which a voltage of 250V D.C. is applied between individual terminals and bushing.</p>	<p>端子-軸受間にて100MΩ以上 Between individual terminals and bushing: 100MΩ MIN.</p>
4-6 耐電圧 Dielectric strength	<p>端子-軸受間にA. C. 300V1分間又は、A. C. 360V2秒間印加する。 (リーク電流1mA) A voltage of 300V A.C. shall be applied for 1min or a voltage of 360V A.C. shall be applied for 2s between individual terminals and bushing. (Leak current: 1mA)</p>	<p>損傷・アーク・絶縁破壊がないこと。 Without damage to parts, arcing or breakdown.</p>

5. 機械的性能 Mechanical characteristics

項目 Item	条件 Conditions	規格 Specifications
5-1 全回転角度 Total rotational angle		<p>360° (エンドレス) 360° (Endless)</p>
5-2 クリックトルク Detent torque	<p>(クリック付きのみ適用) (Applied for with-detent type)</p>	<p>10±7mN·m</p>
回転トルク Rotational torque	<p>(クリックなしのみ適用) (Applied for without-detent type)</p>	
5-3 クリック点数及び位置 Number and position of detents.	<p>(クリック付きのみ適用) (Applied for with-detent type)</p>	<p>18点クリック 18 detents (ステップ角度 20° ± 3°) (Step angle: 20° ± 3°)</p>
5-4 端子強度 Terminal strength	<p>端子先端の任意の方向に5Nの力を1分間加える。 A static load of 5N be applied to the tip of terminals for 1min in any direction.</p>	<p>端子の破損、著しいカクタがないこと。 但し、端子の曲がりは可とする。 Without damage or excessive looseness of terminals. Terminal bend is permitted.</p>

ALPSALPINE CO., LTD.

APPD. C-ENG2 S. URUSHIHARA 2019-05-24	CHKD. C-ENG2 K. SAIJO 2019-05-24	DSGD. C-ENG2 K. SATO 2019-05-24	TITLE 回転形エンコーダ ROTATIONAL ENCODER
ORG SYMB	DATE 1999-10-7	K, I S, M H, M	DOCUMENT NO. 5LA211-E1 (3/4)

Confidential

CLASS No.		TITLE 回転形エンコーダ 規格書 ROTATIONAL ENCODER SPECIFICATION		(SW01)								
項目 Item	条件 Conditions	規格 Specifications										
5-5 軸の押し引き強度 Push-pull strength of shaft	軸の押し及び引張り方向に100Nの力を10秒間加える。 (セット実装状態) Push and pull static load of 100N shall be applied to the shaft in the axial direction for 10s. (After installing)	軸の破損、著しいガタのないこと。 感触に異常がないこと。 Without damage or excessive play in shaft. No excessive abnormality in rotational feeling.										
5-6 軸ガタ Shaft wobble	取付面より30mmの位置に50mN・mの曲げモーメントを加える。 軸長が30mmに満たない場合は右の式による。Lは測定位置(取付面から5の位置)とする。 Bending moment of 50mN・m to be applied to the shaft at 30mm from the mounting surface. If the shaft length is less than 30mm, the value shall be calculated as right formula. L: Measurement point from mounting surface.	軸受長 Bushing length (mm)	軸力 ^タ Wobble 以下 (mmp-p less)	<table border="1"> <tr> <td>5</td> <td>0.8xL/30</td> </tr> <tr> <td>7</td> <td>0.5xL/30</td> </tr> <tr> <td>10</td> <td>0.4xL/30</td> </tr> <tr> <td>20</td> <td>0.25xL/30</td> </tr> </table>	5	0.8xL/30	7	0.5xL/30	10	0.4xL/30	20	0.25xL/30
5	0.8xL/30											
7	0.5xL/30											
10	0.4xL/30											
20	0.25xL/30											
5-7 軸のスラスト方向ガタ Shaft play in axial direction		0.4mm以下 0.4mm MAX.										
5-8 軸の回転方向力 ^タ Rotation play at the click position	(クリック付きのみ適用) (Applied for with-detent type) 角度板にて測定する。 Measure with jig for rotational angle.	4°以内 4° MAX.										
5-9 取付け上の注意 Notice for mounting	右図の様にスイッチ本体を挿えてご使用下さい。セット側でスイッチ本体の引き及び回転方向の力 ^{イト} が無い場合は、はんだ付けだけの固定となり、はんだ付け信頼性及びスイッチ本体強度が不安定となる可能性があります。 Hold the bushing use front panel or light pipe. Because this switch not has thread. If don't hold the bushing, the switch maybe become intermittent rough mounting after soldering by knob stopper face.											

6. 耐久性能 Endurance characteristics.

項目 Item	条件 Conditions	規格 Specifications
6-1 しゅう動寿命性能 Rotational life	無負荷で軸を毎時500サイクルの速さで、15,000サイクル断結動作を行う。 但し、試験途中5,000で中間測定を行う。(1サイクルは、360°1往復) The shaft of encoder shall be rotated to 15,000 cycles at a speed of 500cycles per hour without electrical load, after which measurements shall be made. However, an interim measurement shall be made immediately after 5,000 cycles. (1 cycle: rotate 360° CCW rotate 360° CW)	クリック又は回転トルク 初期規格値に対し ^{+10%} _{-30%} その他、初期規格を満足すること。 Detent or Rotational torque: Relative to the previously specified value. ^{+10%} _{-30%} Except above items, specifications in clause 4.1~6 and 5.1, 5.3 shall be satisfied.

ALPSALPINE CO., LTD.									
APPD.		CHKD.		DSGD.		TITLE			
C-ENG2		C-ENG2		C-ENG2		回転形エンコーダ ROTATIONAL ENCODER			
S.URUSHIHARA		K.SAIJO		K.SATO		DOCUMENT NO.			
2019-05-24		2019-05-24		2019-05-24		5LA211-E1 (4/4)			
ORG	1999-10-7	K	I	S	M	H	M		
SYMB	DATE	APPD	CHKD	DSGD					

CLASS No.	TITLE プッシュモーメンタリスイッチ規格書 PUSH MOMENTARY SWITCH SPECIFICATION	(SW02)
-----------	---	--------

1. 定格容量 (抵抗負荷)
Switch rating (Resistor load) D.C. 5V 0.1A (500μA MIN)

2. 電気的性能 Electrical characteristics

項目 Item	条件 Conditions	規格 Specifications
2-1 接触抵抗 Contact resistance	D.C. 5V1mA電圧降下法にて測定する。 Measured by the 1mA 5V D.C. voltage drop method.	100mΩ MAX.
2-2 チャタリング Chattering	1サイクル (OFF-ON-OFF) 1秒で動作させる。 Switch is operated at the rate of 1 cycle 1s. The 1 cycle shall be OFF-ON-OFF.	10ms以下 Less than 10ms
2-3 絶縁抵抗 Insulation resistance	端子-軸受間にD.C. 250V印加する。 Measurement shall be made under the condition which a voltage of 250VD.C. is applied between individual terminals and bushing.	端子-軸受間に100MΩ以上 Between individual terminals and bushing: 100MΩ MIN.
2-4 耐電圧 Dielectric strength	端子-軸受間にA.C. 300V1分間又は、A.C. 360V2秒間印加する。 (リーク電流1mA) A voltage of 300VA.C. shall be applied for 1min or a voltage of 360VA.C. shall be applied for 2s between individual terminals and bushing. (Leak current:1mA)	損傷・アーク・絶縁破壊がないこと。 Without damage to parts, arcing or breakdown.

注記:
Note: 軸・スイッチ端子間は絶縁されております。
Shaft is insulated from switch terminal.

3. 機械的性能 Mechanical characteristics

項目 Item	条件 Conditions	規格 Specifications
3-1 スイッチ回路・接点数 Contact arrangement		単極単投 (Push on) S.P.S.T. (Push on)
3-2 スイッチ移動量 Switching stroke		0.5±0.3mm
3-3 スイッチ作動力 Switch operation force		6 \pm $\frac{2}{2}$.5N

4. 耐久性能 Endurance characteristics.

項目 Item	条件 Conditions	規格 Specifications
4-1 動作寿命特性 Operating life	無負荷にて軸を毎時500回の速さで20,000回断続動作を行う。 但し、試験途中5,000で中間測定を行う。押し圧:10N以下 The shaft of switch shall be 20,000 times at a speed of 500times per hour without electrical load, after which measurements shall be made. However, an interim measurement shall be made immediately after 5,000 times. Push force:10N MAX.	接触抵抗:200mΩ以下 その他、初期規格を満足すること。 Switch contact resistance:200mΩMAX. Except above items, specifications in clause 2.2~4, and 3.1~3 shall be satisfied.

5. その他 Note

5-1 軸にツマミを取り付け、センターから10mmの位置で押しを時にひっかかり感が無いこと。
No sticky feel shall be observed when the knob on the shaft is pushed at 10mm off the center.

					ALPSALPINE CO., LTD.				
					APPD.	CHKD.	DSGD.	TITLE プッシュモーメンタリスイッチ PUSH MOMENTARY SWITCH	
					S. URUSHIHARA	K. SASAKI	H. MIURA	DOCUMENT NO.	
ORG	'08-2-7	S. I	K. S	H. K	2015-11-10	2015-11-10	2015-11-10	5LA2114-E61 (1/1)	
SYMB	DATE	APPD	CHKD	DSGD					

CLASS No.	TITLE
-----------	-------

1. はんだ耐熱 Resistance to soldering heat

下記の“はんだ付け条件”にて絶縁体の変形、破損のないこと、感触に異常のないこと。
 At the specified by the soldering conditions below.
 There shall be no deformation or cracks, in molded part.
 No excessive abnormality in rotational feeling.

はんだ付け条件 Soldering conditions

手はんだの場合 Manual soldering

⚠ 温度350°C以下、時間3秒以内 ⚠
 Bit temperature of soldering iron : 350°C or less.
 Application time of soldering iron : within 3s.

ディップはんだの場合 Dip soldering

使用基板 : t1.6両面銅張積層板
 Printed wiring board: Both-sided copper clad laminate board with thickness of 1.6mm.

フラックス : 比重0.82以上のフラックスを用い発泡式フラクサーにて発泡面高さは、基板板厚の3分の2。
 Flux:
 ・Specific gravity: 0.82 or more.
 ・Flux shall be applied to the board using a bubble foaming type fluxer.
 ・The board shall be soaked in the flux bubble only to the 2/3 of its thickness.

プリヒート : 基板表面温度100°C以下、時間2分以内
 Preheating:
 ・Surface temperature of board: 100°C or less.
 ・Preheating time: within 2 min.

はんだ : 温度260±5°C、時間5±1秒
 Soldering:
 ・Solder temperature: 260±5°C.
 ・Immersion time: Within 5±1s.

以上の工程を1回または2回通過する。
 Apply the above soldering process for 1 or 2 times.

					ALPSALPINE CO., LTD.					
					APPD.	CHKD.	DSGD.	TITLE		
					1-設2	1-設2	1-設2			
					K. KAWASAKI	S. MIZOBUCHI	H. MIURA	DOCUMENT NO.		
					1997/06/12	1997/06/12	1997/06/11	L-E1 (1/1)		
⚠ 2	2004-02-23	S. M	H. H	H. I						
SYMB	DATE	APPD	CHKD	DSGD						

注記 軸受材質：亜鉛タ^クイキャスト
 軸材質：アルミニウム
 NOTES BUSHING MATERIAL: ZINC ALLOY DIE CASTING
 SHAFT MATERIAL: ALUMINUM

(SW01) ENCODER
 (SW02) PUSH ON SW

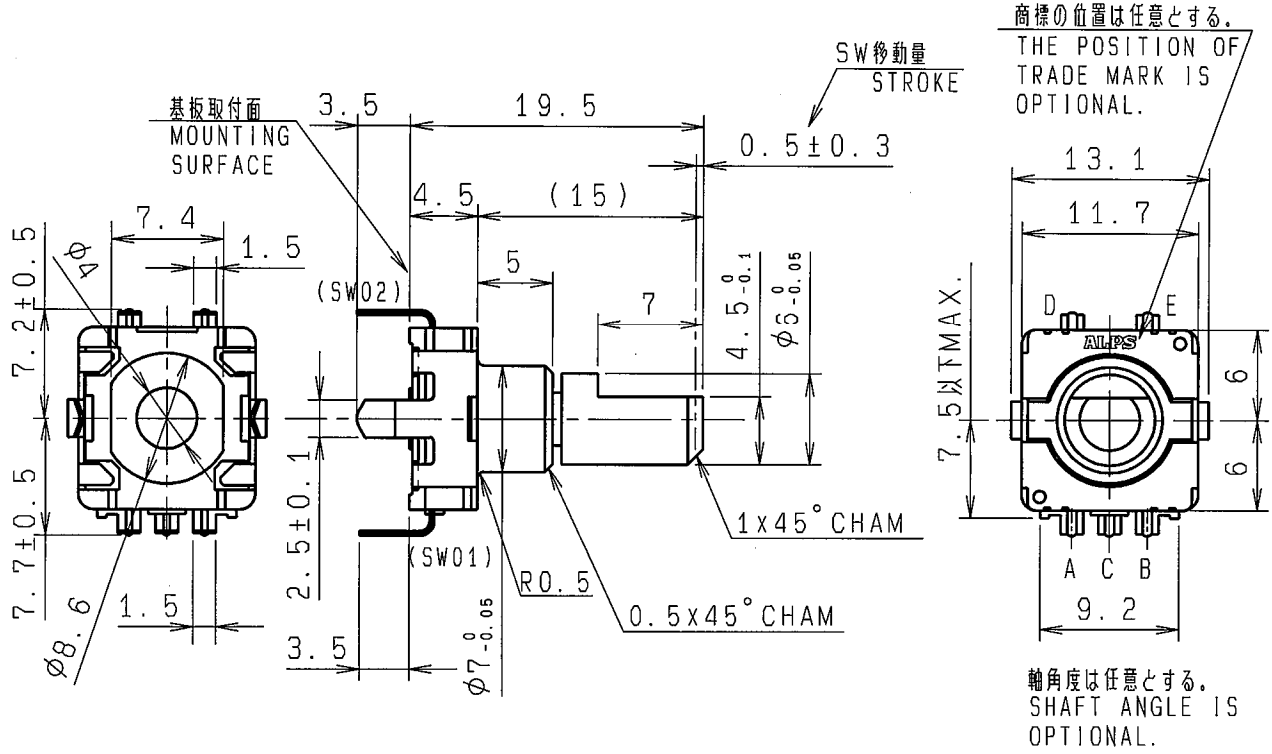

取付穴寸法図 許容差±0.1
 (部品挿入側)
 P.W.B. MOUNTING DETAIL
 TOLERANCE±0.1
 VIEWED FROM MOUNTING SIDE

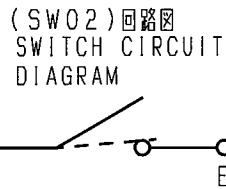
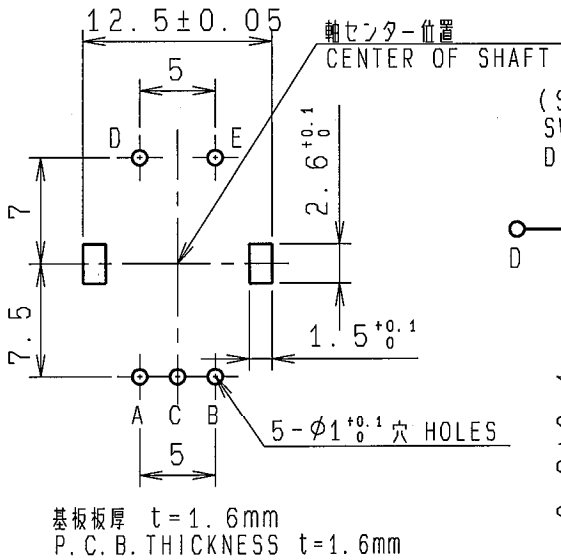

基板挿入部端子形状詳細(3:1)
 TERMINAL DETAIL

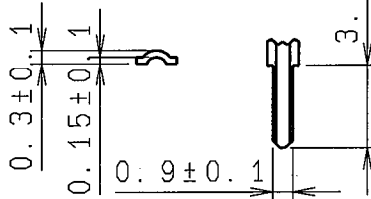

(SW01)出力信号
 ENCODER OUTPUT SIGNAL

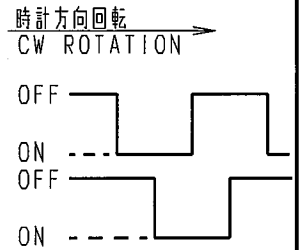

指定なき部分の許容差 TOLERANCES UNLESS OTHERWISE SPEC	
$L \leq 10$	±0.3
$10 < L < 100$	±0.5
$100 \leq L$	±0.8
角度 ANGULAR DIMENSION	±5°

				9P/18C	
PART NO.	NAME	MATERIAL NAME / CODE	FINISH		
ALPS ELECTRIC CO., LTD.					
DSGD.	Y. SHIMIZU	2009-01-06	SCALE	NO.	
CHKD.			2:1		
APPD.			TITLE	11形1軸 PUSH ON SW付エンコーダ ^ク 組立図	
SYMB	DATE	APPD	UNIT	DOCUMENT NO.	
			m m	LA2115E7H	
H. Miura 2009.1.6					

CLASS NO.	TITLE
-----------	-------

<はんだ付け時の注意事項>
Caution for soldering

図のようにP.W.B.の上にはんだ付けをする配線はお避け下さい。
Please avoid soldering on upper surface of P.W.B. as shown

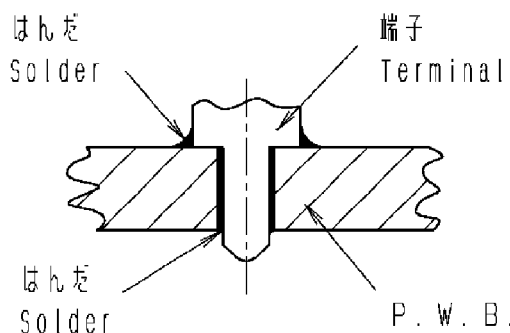

⚠ 基板に挿入される金属足ははんだ付けしてご使用願います。
Solder all metal inserted fixing including terminals & metal lugs into a substrate.

					ALPS ELECTRIC CO., LTD.					
					APPD. DSG1	CHKD. DSG1	DSGD. DSG1	TITLE		
					Y. YOSHIOKA	Y. SATO	Y. OYA	DOCUMENT NO.		
⚠ ₁	'09-01-27	Y, K	Y, K	H, M	1996/01/11	1996/01/11	1996/01/11	4K-1 (1/1)		
SYMB	DATE	APPD	CHKD	DSGD						

X-ON Electronics

Largest Supplier of Electrical and Electronic Components

Click to view similar products for [Coded Rotary Switches](#) category:

Click to view products by [ALPS](#) manufacturer:

Other Similar products are found below :

[PT65503RT](#) [Y36D02243FPLFT](#) [RTAP31S12WFLSP](#) [MADR-16H1](#) [GSER-10](#) [6KF001B-3S10R4-0](#) [EC11E153442W](#) [EC11E1534441](#) [SC-2110](#) [SD-2010TB](#) [MER-16H](#) [EDR-08](#) [USR-10](#) [FSR-08](#) [FSR-04S](#) [ESR-16](#) [HAMR-10S](#) [SDR-10H](#) [QSR-16H](#) [HAMR-16](#) [FDR-04S](#) [EDR-16S](#) [ESR-10S](#) [QDR-08H1](#) [EDR-08S](#) [ESR-16H](#) [QDR-10](#) [EDR-10S](#) [QSR-06S](#) [ESR-08S](#) [EC11E156040N](#) [EC11B15243DC](#) [EC35AH220501](#) [EC18AGB20406](#) [EC11E09244C3](#) [EC11G1534414](#) [EC11E156T402](#) [EC11E1564454](#) [EC11E15204B1](#) [EC11E1564439](#) [EC50A0920403](#) [ED103180-FE14.5S7.5-A16-1010](#) [ED08E42S-FE15C7.0-A16-1020](#) [ED08C030-FE18C9.0-A16-1002X](#) [ED08C210-FE18A6.0-A16-1002](#) [ED08C150-BM20S6.0-A16-1026](#) [ED103010-SP17S8.0-A16-1012](#) [ED113020-FB15S7.0-C12-0005](#) [ED121220-FB20B7.0-C24-0001-G219](#) [ED231010-FB35A10-A40-1001](#)