

CLASS No.	TITLE 回転形エンコーダ 規格書 ROTATIONAL ENCODER SPECIFICATION	EC11B152T408 (SW01)
-----------	---	------------------------

1. 一般事項 General

1-1 適用範囲 Scope

この仕様書は主として電子機器に用いる微小電流回路用11形薄形ロータリーエンコーダに適用する。
This specification applies to 11mm size low-profile rotary encoder (incremental type) for microscopic current circuits, used in electronic equipment.

1-2 標準状態 Standard atmospheric conditions

測定は特に指定のない限り、次の状態で行なう。

Unless otherwise specified, the standard range of atmospheric conditions for making measurements and tests is as follows:

- 温度 Ambient temperature : 15°C to 35°C
- 相対湿度 Relative humidity : 25% to 85%
- 気圧 Air pressure : 86kPa to 106kPa

但し、疑義を生じた場合は、次の標準状態で行なう。

If there is any doubt about the results, measurements shall be made within the following limits:

- 温度 Ambient temperature : 20 ± 1°C
- 相対湿度 Relative humidity : 63% to 67%
- 気圧 Air pressure : 86kPa to 106kPa

1-3 使用温度範囲

Operating temperature range : -40°C to +85°C

1-4 保存温度範囲

Storage temperature range : -40°C to +85°C

2. 構造 Construction

2-1 寸法 Dimensions

添付組立図による。
Refer to attached drawing.

3. 定格 Rating

3-1 定格容量 Rating : D.C. 5V 10mA (1mA MIN)

4. 電気的性能 Electrical characteristics

項目 Item	条件 Conditions	規格 Specifications	
4-1 出力信号 Output signal format	補足) クリック谷位置のA信号、B信号のエンコーダ出力は同電圧となる 設計基準となっております。 Note) The encoder output signal A and B are designed to be the same at the bottom of each detent.	A, B 2信号の位相差出力とし、詳細は<fig. 1>の通りとする。 (破線はクリックの位置を示す。) 2 Phase-different signals (Signal A, signal B) Details shown in <fig. 1>. (The broken line shows detent position.)	
	<Fig 1>		
	回転方向 Shaft rotational direction	信号 Signal	出力波形 OUTPUT
	時計方向 C.W.	A (A-C端子間) A(Terminal A-C)	OFF ON
		B (B-C端子間) B(Terminal B-C)	OFF ON
	反時計方向 C.C.W.	A (A-C端子間) A(Terminal A-C)	OFF ON
		B (B-C端子間) B(Terminal B-C)	OFF ON

P/L
15P/30C
10±7mNm



APPD 設 2 03.4.-2 海渡	CHKD. 設 2 03.4.-2 小原	DSGD. 設 2 03.4.-2 木村	TITLE 回転形エンコーダ ROTATIONAL ENCODER
SYMB	DATE	APPD	CHKD
			DSGD
DOCUMENT NO.			5LA211T-E16(1/5)

O R

CLASS No.	TITLE 回転形エンコーダ 規格書 ROTATIONAL ENCODER SPECIFICATION	(SW01)
-----------	---	--------

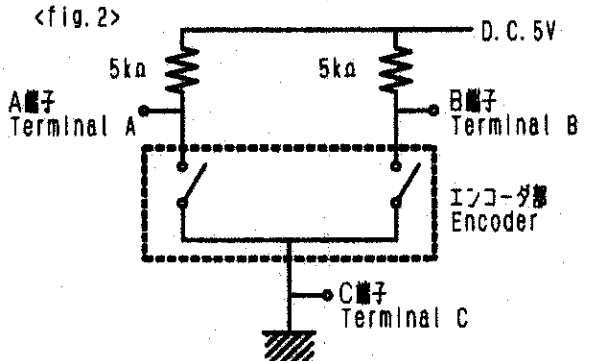
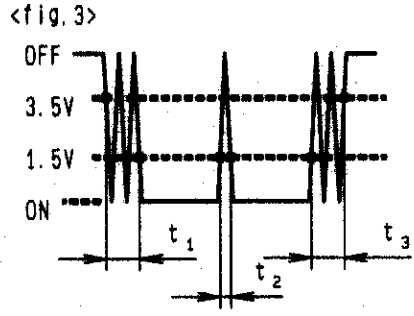
項目 Item	条件 Conditions	規格 Specifications
4-2 分解能 Resolution	1回転で出力されるパルス数 Number of pulses in 360° rotation.	各相15パルス/360° 15 pulses/360° for each phase (2クリック 1パルス) (2click 1pulse)
4-3 スイッチング特性 Switching characteristics	下記測定回路<fig. 2>を用い、回転速度を360°・s ⁻¹ の速さで回転し測定する。 Measurement shall be made under the condition as follows. 1) Shaft rotational speed : 360°・s ⁻¹ 2) Test circuit : <fig. 2>	
	<p><fig. 2></p>  <p>(注記) コードOFF状態 : 出力電圧が3.5V以上の状態を言う。 コードON状態 : 出力電圧が1.5V以下の状態を言う。 (note) Code-OFF area : The area which the voltage is 3.5V or more. code-ON area : The area which the voltage is 1.5V or less.</p>	<p><fig. 3></p> 
1) チャタリング Chattering	コードのOFF→ON及びON→OFFの際の、出力1.5V~3.5Vの通過時間にて規定する。 Specified by the signal's passage time from 3.5V to 1.5V or from 1.5V to 3.5V of each switching position (code OFF→ON or ON→OFF).	$t_1, t_3 \leq 3\text{ms}$
2) 振動ノイズ (バウンス) Sliding noise (Bounce)	コードONの部分の1.5V以上の電圧変動時間とし、チャタリング t_1, t_3 両者との間1ms以上の1.5V以下のON部分を有するものとする。また、振動ノイズ間1.5V以下の範囲が1msある場合は、別の振動ノイズと判断する。 Specified by the time of voltage change exceed 1.5V in code-ON area. When the bounce has code-ON time less than 1ms between chatterings (t_1 or t_3), the voltage change shall be regarded as a part of chattering. When the code-ON time between 2 bounces is less than 1ms, they are regarded as 1 linked bounce.	$t_2 \leq 2\text{ms}$
3) 振動ノイズ Sliding noise	コードOFFの部分の電圧変動 The voltage change in code-OFF area.	3.5V以上 3.5V MIN

ALPS ELECTRIC CO., LTD.

APPD. 03.4.-2 海淵	CHKD. 03.4.-2 小原	DSGD. 03.4.-2 本村	TITLE 回転形エンコーダ ROTATIONAL ENCODER
SYMB DATE APPD CHKD DSGD			DOCUMENT NO. 5LA211T-E16 (2/5)

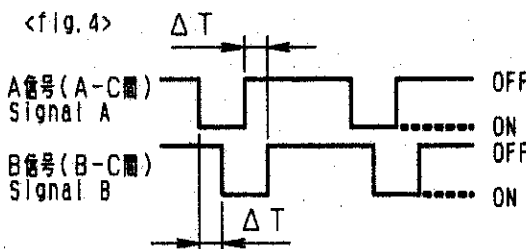
CLASS No.		TITLE	
		回転形エンコーダ 規格書 ROTATIONAL ENCODER SPECIFICATION	(SW01)
項目 Item	条件 Conditions	規格 Specifications	
4-4 位相差 Phase-difference	<p>360°・s⁻¹の定速にて操作軸を回転する。 Measurement shall be made under the condition which the shaft is rotated in 360°・s⁻¹ (constant speed).</p> <p><fig. 4></p>  <p> A信号(A-C間) Signal A OFF ON B信号(B-C間) Signal B OFF ON </p> <p>注意事項：搭輪接点ですので手動操作時の出力波形はご使用されるツマミ径、軸の回転速度によって変化致します。 回路設計時は実装にて確認願います。 Note: Above specification (4-4) is changeable. When operate by manual. Please check performance using actual circuit and knob.</p>	<p><fig. 4>において ΔT≥6ms In<fig. 4></p>	
4-5 絶縁抵抗 Insulation resistance	<p>端子-軸受間にD. C. 250V印加する。 Measurement shall be made under the condition which a voltage of 250V D.C. is applied between individual terminals and bushing.</p>	<p>端子-軸受間にて100MΩ以上 Between individual terminals and bushing: 100Ma MIN.</p>	
4-6 耐電圧 Dielectric strength	<p>端子-軸受間にA. C. 300V1分間又は、A. C. 360V2秒間印加する。 (リーク電流1mA) A voltage of 300VA.C. shall be applied for 1min or a voltage of 360VA.C. shall be applied for 2s between individual terminals and bushing. (Leak current:1mA)</p>	<p>接合・アーク・絶縁破壊がないこと。 Without damage to parts, arcing or breakdown.</p>	

5. 機械的性能 Mechanical characteristics

項目 Item	条件 Conditions	規格 Specifications
5-1 全回転角度 Total rotational angle		<p>360° (エンドレス) 360° (Endless)</p>
5-2 クリックトルク Detent torque	<p>ロック解除時のみ指定する。 Specified only for unlatched state.</p>	<p>10±7mN・m</p>
5-3 クリック点数及び位置 Number and position of detents.		<p>30点クリック 30 detents (ステップ角度 12°±3°) (Step angle:12°±3°)</p>
5-4 端子強度 Terminal strength	<p>端子先端の任意の方向に5Nの力を1分間加える。 A static load of 5N be applied to the tip of terminals for 1min in any direction.</p>	<p>端子の破損、著しいカクタがないこと。 但し、端子の曲がりは可とする。 Without damage or excessive looseness of terminals. Terminal bend is permitted.</p>
5-5 軸の押し引き強度 Push-pull strength of shaft	<p>軸の押し及び引き方向に100Nの力を10秒間加える。 (軸ロック時を除く) (セット実装状態) Push and pull static load of 100N shall be applied to the shaft in the axial direction for 10s. (Specified only for unlatched state.) (After installing)</p>	<p>軸の破損、著しいガタのないこと。 感触に異常がないこと。 Without damage or excessive play in shaft. No excessive abnormality in rotational feeling.</p>

ALPS ELECTRIC CO., LTD.

SYMB	DATE	APPD	CHKD	DSGD	<p>APPD. 03.4.-2 海淵</p> <p>CHKD. 段2 03.4.-2 小原</p> <p>DSGD. 段2 03.4.-2 木村</p>	<p>TITLE 回転形エンコーダ ROTATIONAL ENCODER</p> <p>DOCUMENT NO. 5LA211T-E16(3/5)</p>
------	------	------	------	------	---	---

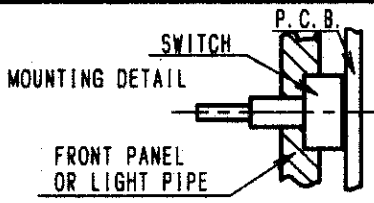
CLASS No.		TITLE 回転形エンコーダ 規格書 ROTATIONAL ENCODER SPECIFICATION		(SW01)
項目 Item	条件 Conditions	規格 Specifications		
5-6 軸の横押し強度 Shaft side strength	製品を固定し、軸に取付面と平行な方向から50.5N・mの力を10秒間加える。 Fix the main body and apply the moment of 0.5N・m to the shaft from the side direction in parallel to the mounting surface for 10 seconds.	軸の曲がりがないこと、 感触に異常がないこと、 Without bends in the shaft. No excessive abnormality in rotational feeling.		
	製品を固定し、軸に取付面と平行な方向から1N・mの力を加える。 Fix the main body and apply the moment of 1N・m to the shaft from the side direction in parallel to the mounting surface.	軸の破損がないこと、 Without any damages.		
5-7 軸ガタ Shaft wobble	取付面より30mmの位置に50mN・mの曲げモーメントを加える。 軸長が30mmに満たない場合は右の式による。Lは測定位置(取付面から50の位置)とする。 (軸ロック解除状態で) Bending moment of 50mN・m to be applied to the shaft at 30mm from the mounting surface. If the shaft length is less than 30mm, the value shall be calculated as right formula. L: Measurement point from mounting surface. (unlatched state)	2XL/30mmφ-D以下 less		
5-8 軸のスラスト方向ガタ Shaft play in axial direction		0.4mm以下 0.4mm MAX.		
5-9 軸の回転方向ガタ Rotation play at the click position	角度板にて測定する。 Measure with Jig for rotational angle.	4°以内 4° MAX.		
5-10 プッシュロック作動力 operation force	プッシュロック時 In push lock	0.5~8N		
	プッシュロック解除時 In push lock released	5±2N		
5-11 取付け上の注意 Notice for mounting	右図の補正スイッチ本体を揃えてご使用下さい。セット側でスイッチ本体の引き及び回転方向の「カイト」が無い場合は、はんだ付けだけの固定となり、はんだ付け信頼性及びスイッチ本体強度が不安定となる可能性があります。 Hold the bushing use front panel or light pipe. Because this switch not has thread. If don't hold the bushing, the switch maybe become intermittent rough mounting after soldering by knob stopper face.			

ALPS ELECTRIC CO., LTD.				
APPD. 03.4.-2 溝田	CHKD. 03.4.-2 小原	DSGD. 03.4.-2 木村	TITLE 回転形エンコーダ ROTATIONAL ENCODER	
DOCUMENT NO. 5LA211T-E16 (4/5)				
SYMB	DATE	APPD	CHKD	DSGD

CLASS NO.	TITLE 回転形エンコーダ 規格書 ROTATIONAL ENCODER SPECIFICATION	(SW01)
-----------	---	--------

6. 耐久性能 Endurance characteristics.

項目 Item	条件 Conditions	規格 Specifications
6-1 しゅう動寿命性能 Rotational life	無負荷で軸を毎時500サイクルの速さで、15,000サイクル断続動作を行う。 但し、試験途中5,000で中間測定を行う。(1サイクルは、360°1往復) The shaft of encoder shall be rotated to 15,000 cycles at a speed of 500cycles per hour without electrical load, after which measurements shall be made. However, an interim measurement shall be made immediately after 5,000 cycles. (1 cycle: rotate 360° CCW rotate 360° CW)	クリックトルクは 初期規格値に対し ^{+10%} _{-30%} その他、初期規格を満足すること。 Detent torque: Relative to the previously specified value. ^{+10%} _{-30%} Except above items, specifications in clause 4.1~6 and 5.1.5.3 shall be satisfied.
6-2 プッシュロック操作寿命 Push-lock operation life :	軸を毎時600回の速さで10,000回断続動作を行う。 The shaft of encoder shall be 10,000 times at a speed of 600 times per hour.	初期規格を満足すること。 Specifications in clause 4.5~6, and 5.4.5.7 shall be satisfied.

7. その他 Notes.

- 7-1 ロック状態で軸を強く引くと破損する場合がありますので軸を引かないよう配慮願います。
Please don't pull the shaft when it's locked because it shall be broken by pulling strongly.

					APPD. 03.4.-2	CHKD. 設2 03.4.-2 小原剛	DSGD. 設2 03.4.-2 木村	TITLE 回転形エンコーダ ROTATIONAL ENCODER
SYMB	DATE	APPD	CHKD	DSGD	DOCUMENT NO. 5LA211T-E16 (5/5)			

CLASS No.	TITLE 回転形エンコーダ 規格書 ROTATIONAL ENCODER SPECIFICATION
-----------	---

1. その他耐久性能 Endurance characteristics.

項目 Item	条件 Conditions	規 格 Specifications												
1-1 高温放置試験 High temperature shelf test	温度 $85\pm 3^{\circ}\text{C}$ の恒温槽中に $1,000\pm 10$ 時間放置後、常温、常湿中に 1.5 時間放置する。 The encoder shall be stored at a temperature of $85\pm 3^{\circ}\text{C}$ for $1,000\pm 10\text{h}$ in a thermostatic chamber. And then the encoder shall be subjected to standard atmospheric conditions for 1.5h , after which measurements shall be made.	クリックまたは回転トルクは初期規格値に対し $\pm 30\%$ 以内のこと Detent or rotational torque: Relative to the previously specified value. $\pm 30\%$ MAX その他初期規格を満足すること。 Shall be meet initial specifications.												
1-2 低温放置試験 Low temperature shelf test	温度 $-40\pm 3^{\circ}\text{C}$ の恒温槽中に $1,000\pm 10$ 時間放置後取り出し表面の水分をみき取り常湿常湿中に 1.5 時間放置する。 The encoder shall be stored at a temperature of $-40\pm 3^{\circ}\text{C}$ for $1,000\pm 10\text{h}$ in a thermostatic chamber. Then the encoder shall be taken out of chamber and its surface moisture shall be removed. And then the encoder shall be subjected to standard atmospheric conditions for 1.5h , after which measurement shall be made.													
1-3 熱衝撃試験 Heat shock test	下表に示した温度サイクルを連続 1000 回行う。表面の水分をみき取り常湿常湿中に 1.5 時間放置後測定する。 The encoder shall be subjected to 1000 successive change of temperature cycles, each as shown in table below. Then its surface moisture shall be removed. And then the encoder shall be subjected to standard atmospheric conditions for 1.5 hour, after which measurements shall be made. <table border="1" style="margin-left: auto; margin-right: auto;"> <thead> <tr> <th>段階</th> <th>温度</th> <th>時間</th> </tr> <tr> <th>Step</th> <th>Temperature</th> <th>Time</th> </tr> </thead> <tbody> <tr> <td>1</td> <td>$-40\pm 3^{\circ}\text{C}$</td> <td>30分</td> </tr> <tr> <td>2</td> <td>$85\pm 2^{\circ}\text{C}$</td> <td>30分</td> </tr> </tbody> </table>		段階	温度	時間	Step	Temperature	Time	1	$-40\pm 3^{\circ}\text{C}$	30分	2	$85\pm 2^{\circ}\text{C}$	30分
段階	温度		時間											
Step	Temperature		Time											
1	$-40\pm 3^{\circ}\text{C}$	30分												
2	$85\pm 2^{\circ}\text{C}$	30分												
1-4 高温高湿通電試験 High temperature and humidity energizing test	定格負荷を加え温度 $60\pm 2^{\circ}\text{C}$ 、湿度 $90\sim 95\%$ の恒温湿槽中に $1,000\pm 10$ 時間放置後、取り出し表面の水分をみき取り常湿常湿中に 1.5 時間放置後測定する。 The rated load shall be applied. The encoder shall be stored at a temperature of $60\pm 2^{\circ}\text{C}$ with relative humidity of 90% to 95% for $1,000\pm 10\text{h}$ in a thermostatic chamber. Then the encoder shall be taken out of the chamber and its surface moisture shall be removed. And then the encoder shall be subjected to standard atmospheric conditions for 1.5h , after which measurement shall be made.													
1-5 結露サイクル Dew condensation cycle	定格負荷を加え下表に示した温度サイクルを連続 1000 回行う。表面の水分をみき取り常湿常湿に 1.5 時間放置後測定する。 The rated load shall be applied. The encoder shall be subjected to 1000 successive change of temperature cycles, each as shown in table below. Then its surface moisture shall be removed. And then the encoder shall be subjected to standard atmospheric conditions for 1.5 hour, after which measurements shall be made. <table border="1" style="margin-left: auto; margin-right: auto;"> <thead> <tr> <th>段階</th> <th>温度</th> <th>時間</th> </tr> <tr> <th>Step</th> <th>Temperature</th> <th>Time</th> </tr> </thead> <tbody> <tr> <td>1</td> <td>$+5^{\circ}\text{C}\pm 3^{\circ}\text{C}$, $90\sim 95\%\text{RH}$</td> <td>20分</td> </tr> <tr> <td>2</td> <td>$+25^{\circ}\text{C}\pm 3^{\circ}\text{C}$, $90\sim 95\%\text{RH}$</td> <td>20分</td> </tr> </tbody> </table>	段階	温度	時間	Step	Temperature	Time	1	$+5^{\circ}\text{C}\pm 3^{\circ}\text{C}$, $90\sim 95\%\text{RH}$	20分	2	$+25^{\circ}\text{C}\pm 3^{\circ}\text{C}$, $90\sim 95\%\text{RH}$	20分	
段階	温度	時間												
Step	Temperature	Time												
1	$+5^{\circ}\text{C}\pm 3^{\circ}\text{C}$, $90\sim 95\%\text{RH}$	20分												
2	$+25^{\circ}\text{C}\pm 3^{\circ}\text{C}$, $90\sim 95\%\text{RH}$	20分												

ALPS ELECTRIC CO., LTD.					
APPD.	CHKD.	DSGD.	TITLE		
05.5.26		05.5.26			
清水		清水	DOCUMENT NO.		
05.5.26			S-E24 (1/1)		

注記 軸受材質:亜鉛ダイキャスト
軸材質:亜鉛ダイキャスト
NOTES BUSHING MATERIAL: ZINC ALLOY DIE CASTING
SHAFT MATERIAL: ZINC ALLOY DIE CASTING

(SW01) ENCODER

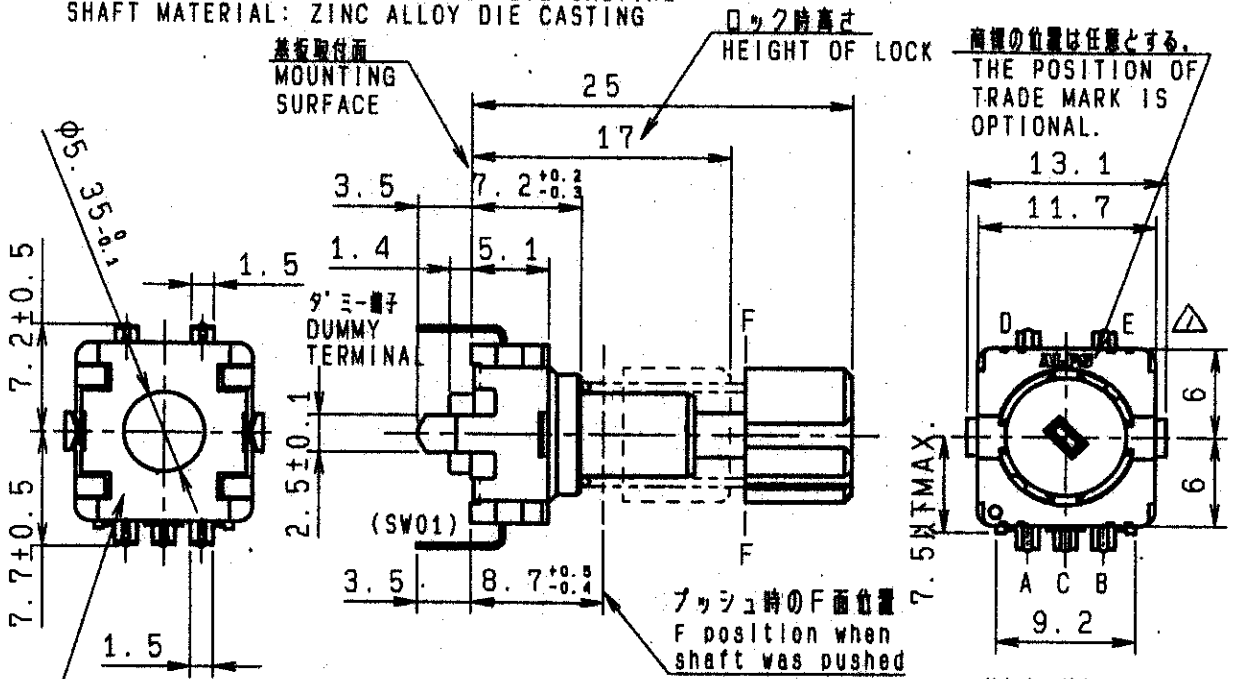

商標の位置は任意とする。
THE POSITION OF TRADE MARK IS OPTIONAL.

軸角度は任意とする。
SHAFT ANGLE IS OPTIONAL.

軸部詳細図
SHAFT DETAIL
6.94 ± 0.03

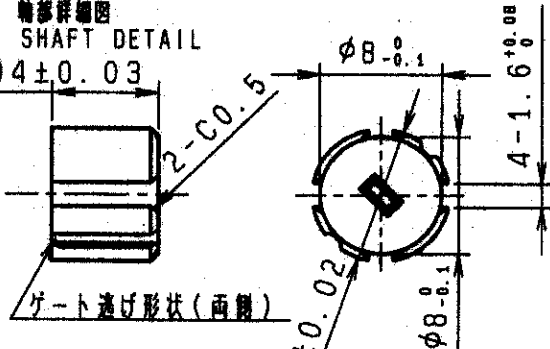

取付穴寸法図 許容差 ± 0.1
(部品挿入側)
P. W. B. MOUNTING DETAIL
TOLERANCE ± 0.1
VIEWED FROM MOUNTING SIDE

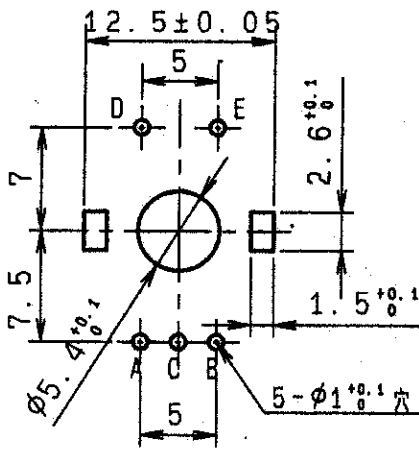

基板板厚 t = 1.6mm
P. C. B. THICKNESS t = 1.6mm

(SW01) 出力信号
ENCODER OUTPUT SIGNAL

時計方向回転
CW ROTATION

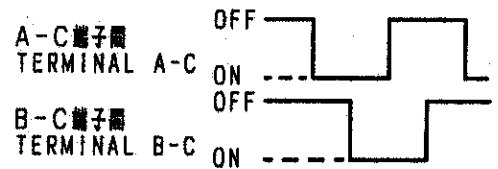

基板挿入部端子形状
TERMINAL DETAIL

指定なき部分の許容差 TOLERANCES UNLESS OTHERWISE SPEC	
L ≤ 10	± 0.3
10 < L < 100	± 0.5
100 ≤ L	± 0.8
角度 ANGULAR DIMENSION	± 5°

				15P/30C			
PART NO.		MATERIAL		SPEC/NAME		FINISH	

ALPS ELECTRIC CO., LTD.

DSGD.	2003-09-01	SCALE	NO.
H. KIMURA		2:1	
CHKD.	2003-09-01	TITLE	11形1軸 PUSH LOCK付エンコーダ組立図
H. Ohana		UNIT	DOCUMENT NO.
S. Mizobuchi 2003-02-01		mm	LA211TE0J

△	2004-03-16	相沢	一	木村	
ORG	2003-01-18	S. AH. KH. O			
NO.	SYMB	DATE	APPD	CHKD	DSGD

2004.3.17
2003.9.9

OR

X-ON Electronics

Largest Supplier of Electrical and Electronic Components

Click to view similar products for [Coded Rotary Switches](#) category:

Click to view products by [ALPS](#) manufacturer:

Other Similar products are found below :

[PT65503RT](#) [P60A703](#) [RTAP31S12WFLSP](#) [GSER-10](#) [GT-EVA01AA-L1](#) [EC11L1525G01](#) [EC111012000Y](#) [EC28B1550404](#) [EC11E0940501](#)
[RT004D](#) [EC11E152T40B](#) [EC11J152540Z](#) [EC11E156040J](#) [EC11E156445M](#) [EC09E152440T](#) [EC11E09444A8](#) [EC11E152T408](#)
[EC10E1220515](#) [EC12E24404A9](#) [EC11G1560418](#) [01-1104](#) [01-1123](#) [01-1234](#) [01-1424](#) [01-1433](#) [07-3153](#) [07-3154](#) [CRD10CM0SBR](#)
[DRS4116](#) [RTE1600R44](#) [ERD110RSZ](#) [ERD116CSZ](#) [ERD116RFZ](#) [ERD116RSZ](#) [94HCB10T](#) [94HBB16WT](#) [94HBB16RAT](#) [94HBB10WT](#)
[94HBB10RAT](#) [94HBB08RAT](#) [94HAC10T](#) [94HAB16WT](#) [94HAB16T](#) [94HAB10WT](#) [94HAB10RAT](#) [94HAB08WT](#) [94HAB08RAT](#)
[ERD216RSZ](#) [P65SMT101](#) [P65SMT103](#)