

CLASS No.	TITLE 回転形エンコーダ 規格書 ROTATIONAL ENCODER SPECIFICATION	EC11E153442W (SW01)
-----------	---	------------------------

1. 一般事項 General

1-1 適用範囲 Scope

この仕様書は主として電子機器に用いる微小電流回路用11形薄形ロータリーエンコーダに適用する。
This specification applies to 11mm size low-profile rotary encoder (incremental type) for microscopic current circuits, used in electronic equipment.

1-2 標準状態 Standard atmospheric conditions

測定は特に指定のない限り、次の状態で行なう。
Unless otherwise specified, the standard range of atmospheric conditions for making measurements and tests is as follows:

- 温度 Ambient temperature : 15°C to 35°C
- 相対湿度 Relative humidity : 25% to 85%
- 気圧 Air pressure : 86kPa to 106kPa

但し、疑義を生じむ場合は、次の基準状態で行なう。

If there is any doubt about the results, measurements shall be made within the following limits:

- 温度 Ambient temperature : 20 ± 1°C
- 相対湿度 Relative humidity : 63% to 67%
- 気圧 Air pressure : 86kPa to 106kPa

1-3 使用温度範囲

Operating temperature range : Δ -40°C to +85°C
: ~~-30°C to +70°C~~

1-4 保存温度範囲

Storage temperature range : -40°C to +85°C

2. 構造 Construction

2-1 寸法 Dimensions

添付組立図による。
Refer to attached drawing.

3. 定格 Rating

3-1 定格容量 Rating : D.C. 5V 10mA (1mA MIN)

4. 電気的性能 Electrical characteristics

項目 Item	条件 Conditions	規格 Specifications
4-1 出力信号 Output signal format		A, B2信号の位相差出力とし、詳細は<fig. 1>の通りとする。 2 Phase-different signals (SignalA, signalB) Details shown in <fig.1>.
<Fig 1>		
	回転方向 Shaft rotational direction	信号 Signal
	時計方向 C. W.	A(A-C端子間) A(Terminal A-C)
		B(B-C端子間) B(Terminal B-C)
	反時計方向 C. C. W.	A(A-C端子間) A(Terminal A-C)
		B(B-C端子間) B(Terminal B-C)

EC11E153
15P/C集
トルク
7mN・m
横押し

ALPS ALPS ELECTRIC CO., LTD.				
APPD	CHKD	DSGD	TITLE 回転形エンコーダ ROTATIONAL ENCODER	
設2 02.9.30 相沢	設2 02.9.27 林	設2 02.9.27 木村	DOCUMENT NO. 5LA211-E149 (1/4)	
△	2004.08.25	相沢	木村	清水
SYMB	DATE	APPD	CHKD	DSGD

CLASS No.	TITLE 回転形エンコーダ 規格書 ROTATIONAL ENCODER SPECIFICATION	(SW01)
-----------	---	--------

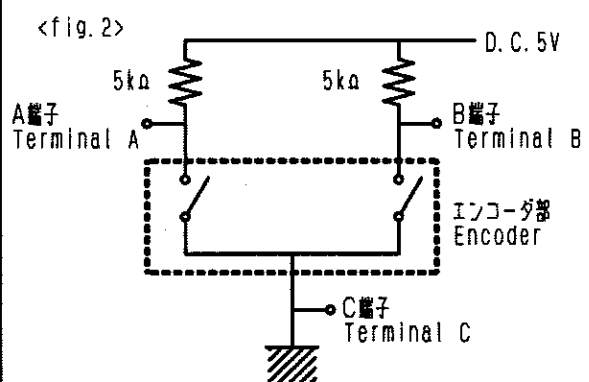
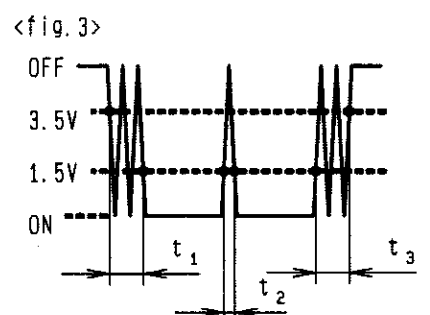
項目 Item	条件 Conditions	規格 Specifications
4-2 分解能 Resolution	1回転にて出力されるパルス数 Number of pulses in 360° rotation.	各相15パルス/360° 15 pulses/360° for each phase
4-3 スイッチング特性 Switching characteristics	<p>下記測定回路<fig. 2>を用い、回転軸を$360^\circ \cdot s^{-1}$の速さで回転し測定する。 Measurement shall be made under the condition as follows.</p> <p>1) Shaft rotational speed : $360^\circ \cdot s^{-1}$ 2) Test circuit : <fig. 2></p> <p><fig. 2></p>  <p><fig. 3></p>  <p>(注記) コードOFF状態 : 出力電圧が3.5V以上の状態を言う。 コードON状態 : 出力電圧が1.5V以下の状態を言う。 (note) Code-OFF area : The area which the voltage is 3.5V or more. code-ON area : The area which the voltage is 1.5V or less.</p>	
1) チャタリング Chattering	コードのOFF→ON及びON→OFFの際の、出力1.5V~3.5Vの通過時間にて規定する Specified by the signal's passage time from 3.5V to 1.5V or from 1.5V to 3.5V of each switching position (code OFF→ON or ON→OFF).	$t_1, t_3 \leq 3ms$
2) 揺動ノイズ (バウンス) Sliding noise (Bounce)	コードONの部分の1.5V以上の電圧変動時間とし、チャタリング t_1, t_3 両者との間に1ms以上の1.5V以下のON部分を有するものとする。また、揺動ノイズ間に1.5V以下の範囲が1msある場合は、別の揺動ノイズと判断する。 Specified by the time of voltage change exceed 1.5V in code-ON area. When the bounce has code-ON time less than 1ms between chatterings (t_1 or t_3), the voltage change shall be regarded as a part of chattering. When the code-ON time between 2 bounces is less than 1ms, they are regarded as 1 linked bounce.	$t_2 \leq 2ms$
3) 揺動ノイズ Sliding noise	コードOFFの部分の電圧変動 The voltage change in code-OFF area.	3.5V以上 3.5V MIN

ALPS ALPS ELECTRIC CO., LTD.				
SYMB	DATE	APPD	CHKD	DSGD
		設2 02.9.30 相沢	設2 02.9.27 林	設2 02.9.27 木村
TITLE 回転形エンコーダ ROTATIONAL ENCODER			DOCUMENT NO. 5LA211-E149 (2/4)	

CLASS No.	TITLE		
	回転形エンコーダ 規格書 ROTATIONAL ENCODER SPECIFICATION		(SW01)
項目 Item	条件 Conditions	規格 Specifications	
4-4 位相差 Phase-difference	<p>360°・s⁻¹の定速にて操作軸を回転する。 Measurement shall be made under the condition which the shaft is rotated in 360°・s⁻¹ (constant speed).</p> <p><fig.4></p> <p>注意事項：搭動接点ですので手動操作時の出力波形はご使用されるツマミ径、軸の回転速度によって変化致します。回路設計時は実装にて確認願います。 Note: Above specification (4-4) is changeable. When operate by manual. Please check performance using actual circuit and knob.</p>	<p><fig.4>において ΔT ≥ 6ms ln < fig.4 ></p>	
4-5 絶縁抵抗 Insulation resistance	<p>端子-軸受間D.C. 250V印加する。 Measurement shall be made under the condition which a voltage of 250V D.C. is applied between individual terminals and bushing.</p>	<p>端子-軸受間にて100MΩ以上 Between individual terminals and bushing: 100MΩ MIN.</p>	
4-6 耐電圧 Dielectric strength	<p>端子-軸受間A.C. 300V1分間又は、A.C. 360V2秒間印加する。 (リーク電流1mA) A voltage of 300V A.C. shall be applied for 1min or a voltage of 360V A.C. shall be applied for 2s between individual terminals and bushing. (Leak current: 1mA)</p>	<p>損傷・アーク・絶縁破壊がないこと。 Without damage to parts, arcing or breakdown.</p>	

5. 機械的性能 Mechanical characteristics

項目 Item	条件 Conditions	規格 Specifications	
5-1 全回転角度 Total rotational angle		360° (エンドレス) 360° (Endless)	
5-2 回転トルク Rotational torque		7 ⁺³ ₋₄ mN・m (始動トルクは除く) (Except starting torque.)	
5-3 端子強度 Terminal strength	<p>端子先端の任意の方向に5Nの力を1分間加える。 A static load of 5N be applied to the tip of terminals for 1min in any direction.</p>	<p>端子の破損、著しい力タがないこと。 但し、端子の曲がりは可とする。 Without damage or excessive looseness of terminals. Terminal bend is permitted.</p>	

ALPS ALPS ELECTRIC CO., LTD.						
SYMB	DATE	APPD	CHKD	DSGD	APPD 設2 02.9.30 相沢 CHKD 設2 02.9.27 林 DSGD 設2 02.9.27 木村	TITLE 回転形エンコーダ ROTATIONAL ENCODER DOCUMENT NO. 5LA211-E149 (3/4)

CLASS NO.	TITLE 回転形エンコーダ 規格書 ROTATIONAL ENCODER SPECIFICATION	(SW01)
-----------	---	--------

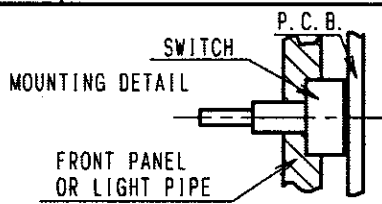
項目 Item	条件 Conditions	規格 Specifications						
5-4 軸の押し引き強度 Push-pull strength of shaft	軸の押し及び引き方向に100Nの力を10秒間加える。 (セット実装状態) Push and pull static load of 100N shall be applied to the shaft in the axial direction for 10s. (After installing)	軸の破損、著しいガタのないこと。 感度に異常がないこと。 Without damage or excessive play in shaft. No excessive abnormality in rotational feeling.						
5-5 軸の横押し強度 Side Push strength of shaft	製品を固定し、軸に取付面と平行な方向から以下の力を10秒間加える。 Fix the main body and apply the following bending moment to the shaft from the side direction in parallel to the mounting surface for 10 seconds. <table border="1" style="margin: 10px auto;"> <tr> <td>軸受長 Bushing length (mm)</td> <td>力(モーメント) Bending Moment (N·m)</td> </tr> <tr> <td>5</td> <td>1.5</td> </tr> <tr> <td>7以上 MIN.</td> <td>2.0</td> </tr> </table>	軸受長 Bushing length (mm)	力(モーメント) Bending Moment (N·m)	5	1.5	7以上 MIN.	2.0	軸の破損、曲がりがないこと。 感度に異常がないこと。 Without any damages and bends in the shaft. No excessive abnormality in rotational feeling.
軸受長 Bushing length (mm)	力(モーメント) Bending Moment (N·m)							
5	1.5							
7以上 MIN.	2.0							
5-6 軸ガタ Shaft wobble	取付面より30mmの位置に50mN·mの曲げモーメントを加える。 軸長が30mmに満たない場合は右の式による。Lは測定位置(取付面からの位置)とする。 Bending moment of 50mN·m to be applied to the shaft at 30mm from the mounting surface. If the shaft length is less than 30mm, the value shall be calculated as right formula. L: Measurement point from mounting surface.	軸受長 軸ガタ Bushing Wobble length 以下 (mm) (mmp-p less) 5 0.8xL/30 7 0.5xL/30 10 0.4xL/30						
5-7 軸のスラスト方向ガタ Shaft play in axial direction		0.15mm以下 0.15mm MAX.						
5-8 軸の回転方向ガタ Rotation play at the click position	角度板にて測定する。 Measure with jig for rotational angle.	4°以内 4° MAX.						
5-9 取付け上の注意 Notice for mounting	右図の様子スイッチ本体を挿えてご使用下さい。セット側でスイッチ本体の引き及び回転方向の「イト」が無い場合は、はんだ付けだけの固定となり、はんだ付け信頼性及びスイッチ本体強度が不安定となる可能性があります。 Hold the bushing use front panel or light pipe. Because this switch not has thread. If don't hold the bushing, the switch maybe become intermittent rough mounting after soldering by knob stopper face.							

6. 耐久性能 Endurance characteristics.

項目 Item	条件 Conditions	規格 Specifications
6-1 しゅう動寿命性能 Rotational life	無負荷で軸を毎時500サイクルの速さで、15,000サイクル連続動作を行う。 但し、試験途中5,000で中間測定を行う。(1サイクルは、360°1往復) The shaft of encoder shall be rotated to 15,000 cycles at a speed of 500cycles per hour without electrical load, after which measurements shall be made. However, an interim measurement shall be made immediately after 5,000 cycles. (1 cycle: rotate 360° CCW rotate 360° CW)	回転トルクは 初期規格値に対し ^{+10%} _{-30%} その他、初期規格を満足すること。 Rotational torque: Relative to the previously specified value. ^{+10%} _{-30%} Except above items, specifications in clause 4.1~6 and 5.1 shall be satisfied.

 ALPS ELECTRIC CO., LTD.				
APPD. 設 2 03.8.-8 溝 潤	CHKD. 設 2 03.8.-7 小原 潤	DSGD. 設 2 03.8.-7 木村	TITLE 回転形エンコーダ ROTATIONAL ENCODER	DOCUMENT NO. 5LA211-E149 (4/4)
初設 SYMB	2002-09-30 DATE	相沢 APPD	村 CHKD	木村 DSGD

CLASS NO.	TITLE プッシュモーメンタリスイッチ規格書 PUSH MOMENTARY SWITCH SPECIFICATION	(SW02)
-----------	---	--------

1. 定格容量 (抵抗負荷)
Switch rating (Resistor load) D. C. 16V0. 5A (1mA MIN)

2. 電気的性能 Electrical characteristics

項目 Item	条件 Conditions	規格 Specifications
2-1 接触抵抗 Contact resistance	D. C. 5V1mA電圧降下法にて測定する。 Measured by the 1mA 5V D. C. voltage drop method.	100mΩ MAX.
2-2 チャタリング Chattering	1サイクル (OFF-ON-OFF) 1秒で動作させる。 Switch is operated at the rate of 1 cycle 1s. The 1 cycle shall be OFF-ON-OFF.	10ms以下 Less than 10ms
2-3 絶縁抵抗 Insulation resistance	端子-軸受間D. C. 250V印加する。 Measurement shall be made under the condition which a voltage of 250V D. C. is applied between individual terminals and bushing.	端子-軸受間にて100MΩ以上 Between individual terminals and bushing: 100MΩ MIN.
2-4 耐電圧 Dielectric strength	端子-軸受間A. C. 300V1分間又は、A. C. 360V2秒間印加する。 (リーク電流1mA) A voltage of 300V A. C. shall be applied for 1min or a voltage of 360V A. C. shall be applied for 2s between individual terminals and bushing. (Leak current: 1mA)	損傷・アーク・絶縁破壊がないこと。 Without damage to parts. arcing or breakdown.

注記:
Note: 軸・スイッチ端子間は絶縁されております。
Shaft is insulated from switch terminal.

3. 機械的性能 Mechanical characteristics

項目 Item	条件 Conditions	規格 Specifications
3-1 スイッチ回路・接点数 Contact arrangement		単極単投 (Push on) S. P. S. T. (Push on)
3-2 スイッチ移動量 Switching stroke		0. 5±0. 3mm
3-3 スイッチ作動力 Switch operation force		6 ⁺² / ₋₂ N

4. 耐久性能 Endurance characteristics.

項目 Item	条件 Conditions	規格 Specifications
4-1 動作寿命特性 Operating life	無負荷にて軸を毎時500回の速さで20, 000回断続動作を行う。 但し、試験途中5, 000で中間測定を行う。押し圧: 10N以下 The shaft of switch shall be 20, 000 times at a speed of 500times per hour without electrical load. after which measurements shall be made. However, an interim measurement shall be made immediately after 5, 000 times. Push force: 10N MAX.	接触抵抗: 200mΩ以下 その他、初期規格を満足すること。 Switch contact resistance: 200mΩ MAX. Except above items. specifications in clause 2. 2~4. and 3. 1~3 shall be satisfied.

5. その他 Note

5-1 軸にツマミを取り付け、センターから10mmの位置で押しを時にひっかり感が無いこと。
No sticky feel shall be observed when the knob on the shaft is pushed at 10mm off the center.

6. 注意事項 Note

6-1 プッシュスイッチ付きのエンコーダは、軸が押されたままの状態では梱包や保管をされず、スイッチ部に支障をきたす恐れがありますのでご配慮下さい。
Encoder equipped with a push-on switches are packaged or stored with their shafts being pushed-in. the switch part may be out of order and pay attention when you package or store them.

					ALPS ELECTRIC CO., LTD.				
SYMB		DATE	APPD	CHKD	DSGD	APPD.	CHKD.	DSGD.	TITLE
						1-2G	1-2G	1-2G	プッシュモーメンタリスイッチ PUSH MOMENTARY SWITCH
						S. AIZAWA	S. MIZOBUCHI	H. MIURA	DOCUMENT NO.
						2000/12/11	2000/12/11	2000/12/07	5LA2114-E30 (1/1)

CLASS No.	TITLE 回転形エンコーダ' 規格書 ROTATIONAL ENCODER SPECIFICATION	
-----------	--	--

1. その他耐久性能 Endurance characteristics.

項目 Item	条件 Conditions	備 考 Specifications												
1-1 高温放置試験 High temperature shelf test	温度 $85\pm 3^{\circ}\text{C}$ の恒温槽中 $1,000\pm 10$ 時間放置後、常温、常温中 1.5 時間放置する。 The encoder shall be stored at a temperature of $85\pm 3^{\circ}\text{C}$ for $1,000\pm 10\text{h}$ in a thermostatic chamber. And then the encoder shall be subjected to standard atmospheric conditions for 1.5h . after which measurements shall be made.	クリックまたは回転トルクは 額定値の $\pm 30\%$ 以内のこと Detent or rotational torque: Relative to the previously specified value. $\pm 30\%$ MAX その他規定値を満足すること。 shall be meet initial specifications.												
1-2 低温放置試験 Low temperature shelf test	温度 $-40\pm 3^{\circ}\text{C}$ の恒温槽中 $1,000\pm 10$ 時間放置後取り出し表面の水分をふき取り 常温常湿中 1.5 時間放置する。 The encoder shall be stored at a temperature of $-40\pm 3^{\circ}\text{C}$ for $1,000\pm 10\text{h}$ in a thermostatic chamber. Then the encoder shall be taken out of chamber and its surface moisture shall be removed. And then the encoder shall be subjected to standard atmospheric conditions for 1.5h . after which measurement shall be made.													
1-3 熱衝撃試験 Heat shock test	下表に示した温度サイクルを連続1000回行う。表面の水分をふき取り常温常湿中 1.5 時間放置後測定する。 The encoder shall be subjected to 1000 successive change of temperature cycles, each as shown in table below. Then its surface moisture shall be removed. And then the encoder shall be subjected to standard atmospheric conditions for 1.5 hour. after which measurements shall be made. <table style="margin-left: auto; margin-right: auto;"> <tr> <td>段階</td> <td>温度</td> <td>時間</td> </tr> <tr> <td>Step</td> <td>Temperature</td> <td>Time</td> </tr> <tr> <td>1</td> <td>$-40\pm 3^{\circ}\text{C}$</td> <td>30 min.</td> </tr> <tr> <td>2</td> <td>$85\pm 2^{\circ}\text{C}$</td> <td>30 min.</td> </tr> </table>		段階	温度	時間	Step	Temperature	Time	1	$-40\pm 3^{\circ}\text{C}$	30 min.	2	$85\pm 2^{\circ}\text{C}$	30 min.
段階	温度		時間											
Step	Temperature		Time											
1	$-40\pm 3^{\circ}\text{C}$	30 min.												
2	$85\pm 2^{\circ}\text{C}$	30 min.												
1-4 高温高湿通電試験 High temperature and humidity energizing test	定格負荷を加え温度 $60\pm 2^{\circ}\text{C}$ 、湿度 $90\sim 95\%$ の恒温湿槽中 $1,000\pm 10$ 時間放置後、取り出し表面の水分をふき取り常温常湿中 1.5 時間放置後測定する。 The rated load shall be applied. The encoder shall be stored at a temperature of $60\pm 2^{\circ}\text{C}$ with relative humidity of 90% to 95% for $1,000\pm 10\text{h}$ in a thermostatic chamber. Then the encoder shall be taken out of the chamber and its surface moisture shall be removed. And then the encoder shall be subjected to standard atmospheric conditions for 1.5h . after which measurement shall be made.													
1-5 ガス腐食試験 Gaseous corrosion test	無負荷で、 H_2S 濃度 10ppm 、温度 $40\pm 2^{\circ}\text{C}$ 、湿度 80% RHの槽中 240 時間放置する。 The encoder shall be stored at a H_2S density of 10ppm . with temperature of $40\pm 2^{\circ}\text{C}$. relative humidity of 80% RH for 240 hours in a thermostatic chamber without load.													

ALPS ELECTRIC CO., LTD.				
			APPD. 池之上 06.6.29	CHKD.
			DSGP 清水 06.6.29	TITLE
				DOCUMENT NO.
SYMB	DATE	APPD	CHKD	DSGP

S-E26 (1/1)

CR

CLASS No.	TITLE
-----------	-------

1. はんだ耐熱 Resistance to soldering heat

下記の「はんだ付け条件」にて絶縁体の変形、破損のないこと、感熱に異常のないこと。
 At the specified by the soldering conditions below.
 There shall be no deformation or cracks, in molded part.
 No excessive abnormality in rotational feeling.

はんだ付け条件 Soldering conditions

手はんだの場合 Manual soldering

温度 350°C 以下、時間 3 秒以内
 Bit temperature of soldering iron : 350°C or less.
 Application time of soldering iron : within 3s.

ディップはんだの場合 Dip soldering

使用基板 : t1.6 両面銅張積層板
 Printed wiring board: Both-sided copper clad laminate board with thickness of 1.6mm.

フラックス : 比重 0.82 以上のフラックスを用い発泡式フラクサーにて発泡面高さは、基板厚の 3 分の 2。
 Flux:
 ・Specific gravity: 0.82 or more.
 ・Flux shall be applied to the board using a bubble foaming type fluxer.
 ・The board shall be soaked in the flux bubble only to the 2/3 of its thickness.

プリヒート : 基板表面温度 100~140°C、時間 40 秒以内
 Preheating:
 ・Surface temperature of board: 100 to 140°C.
 ・Preheating time: within 40 s.

はんだ : 温度 265°C 以下、時間 10 秒以内
 Soldering:
 ・Solder temperature: 265°C or less.
 ・Immersion time: within 10 s.

以上の工程を 1 回または 2 回通過する。
 Apply the above soldering process for 1 or 2 times.

					ALPS ELECTRIC CO., LTD.				
SYMB	DATE	APPD	CHKD	DSGD	APPD	CHKD	DSGD	TITLE	DOCUMENT NO.
									L-E28 (1/1)
					L-E28 (1/1)				

注記 軸受材質：亜鉛タ イキキャスト
 軸材質：アルミニウム
 NOTES BUSHING MATERIAL: ZINC ALLOY DIE CASTING
 SHAFT MATERIAL: ALUMINUM

(SW01) ENCODER
 (SW02) PUSH ON SW

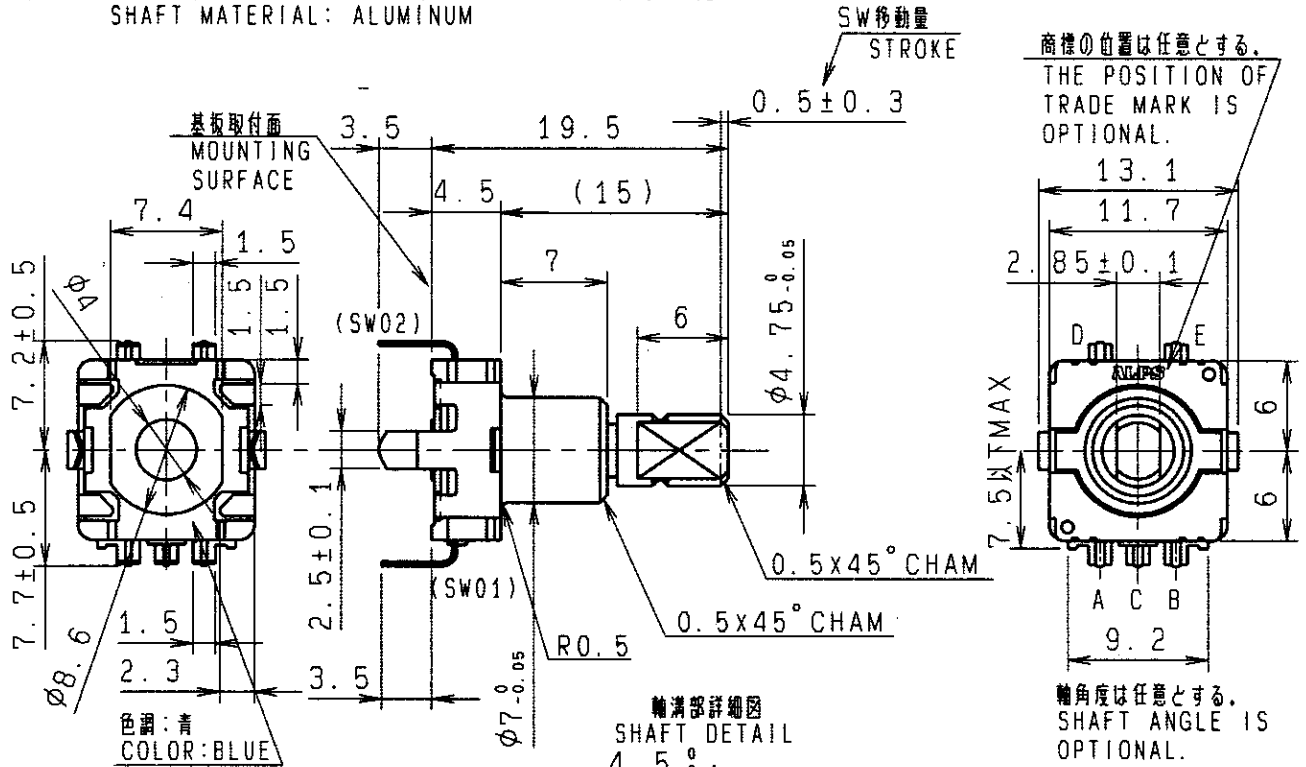

取付穴寸法図 許容差±0.1
 (部品挿入側)
 P. W. B. MOUNTING DETAIL
 TOLERANCE±0.1(REFERENCE)
 VIEWED FROM MOUNTING SIDE.

軸溝部詳細図
SHAFT DETAIL
4.5-0.1

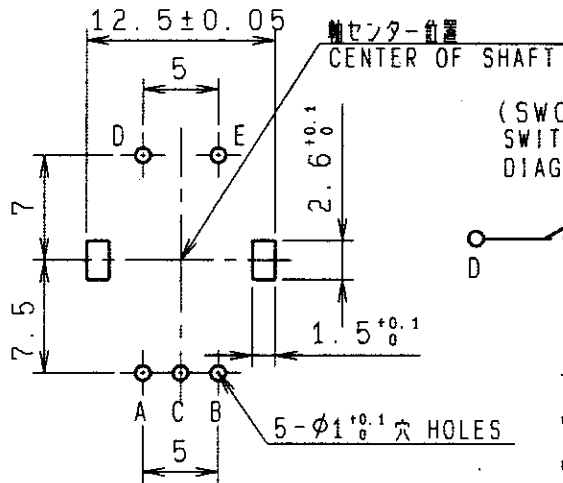
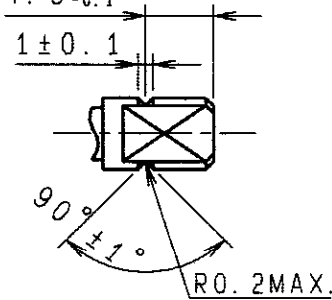

(SW02)回路図
SWITCH CIRCUIT
DIAGRAM

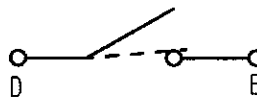

基板挿入部端子形状詳細(3:1)
TERMINAL DETAIL

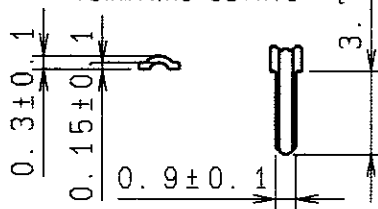

(SW01)出力信号
ENCODER OUTPUT SIGNAL

時計方向回転
CW ROTATION

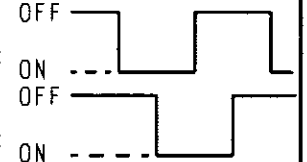

基板板厚 t=1.6mm
P.C.B. THICKNESS t=1.6mm

指定なき部分の許容差 TOLERANCES UNLESS OTHERWISE SPEC	
L ≤ 10	±0.3
10 < L < 100	±0.5
100 ≤ L	±0.8
角度 ANGULAR DIMENSION	±5°

			15P/クリック無		
PART NO.	NAME	MATERIAL NAME / CODE	FINISH		

ALPS ELECTRIC CO., LTD.

DSGD.	Y. SHIMIZU 2006-06-15	SCALE	2:1	NO.	
CHKD.	<i>Y. Shimizu</i> 2006-06-27	TITLE 11形1軸 PUSH ON SW付エンコーダ 組立図			
APPD.	<i>Y. Ohya</i> 2006-06-27	UNIT	mm	DOCUMENT NO.	LA2115E54
SYMB	DATE	APPD	CHKD	DSGD	

X-ON Electronics

Largest Supplier of Electrical and Electronic Components

Click to view similar products for [Coded Rotary Switches](#) category:

Click to view products by [ALPS](#) manufacturer:

Other Similar products are found below :

[PT65503RT](#) [Y36D02243FPLFT](#) [RTAP31S12WFLSP](#) [MADR-16H1](#) [GSER-10](#) [6KF001B-3S10R4-0](#) [EC11E153442W](#) [EC11E1534441](#) [SC-2110](#) [SD-2010TB](#) [MER-16H](#) [EDR-08](#) [USR-10](#) [FSR-08](#) [FSR-04S](#) [ESR-16](#) [HAMR-10S](#) [SDR-10H](#) [QSR-16H](#) [HAMR-16](#) [FDR-04S](#) [EDR-16S](#) [ESR-10S](#) [QDR-08H1](#) [EDR-08S](#) [ESR-16H](#) [QDR-10](#) [EDR-10S](#) [QSR-06S](#) [ESR-08S](#) [EC11E156040N](#) [EC11B15243DC](#) [EC35AH220501](#) [EC18AGB20406](#) [EC11E09244C3](#) [EC11G1534414](#) [EC11E156T402](#) [EC11E1564454](#) [EC11E15204B1](#) [EC11E1564439](#) [EC50A0920403](#) [ED103180-FE14.5S7.5-A16-1010](#) [ED08E42S-FE15C7.0-A16-1020](#) [ED08C030-FE18C9.0-A16-1002X](#) [ED08C210-FE18A6.0-A16-1002](#) [ED08C150-BM20S6.0-A16-1026](#) [ED103010-SP17S8.0-A16-1012](#) [ED113020-FB15S7.0-C12-0005](#) [ED121220-FB20B7.0-C24-0001-G219](#) [ED231010-FB35A10-A40-1001](#)