



21mm Size Ring Type EC21A/EC21C Series

Part number		EC21A1520401	
Actuator length		9mm	
Detent torque		16±7mN·m	
Number of detent		30	
Number of pulse		15	
Operating temperature range		-40°C to +85°C	
Electrical performance	Ratings	10mA 5V DC	
	Output signal	Two phase A and B	
	Max./min. operating current(Resistive load)	10mA/1mA	
	Insulation resistance	100MΩ min. 250V DC	
	Voltage proof	300V AC for 1 minute or 360V AC for 2s	
Mechanical performance	Actuator strength	Pushing direction	100N
		Pulling direction	100N
Durability	Operating life	50,000 cycles	

Minimum order unit (pcs.)

Japan

600

Export

1,200

Photo

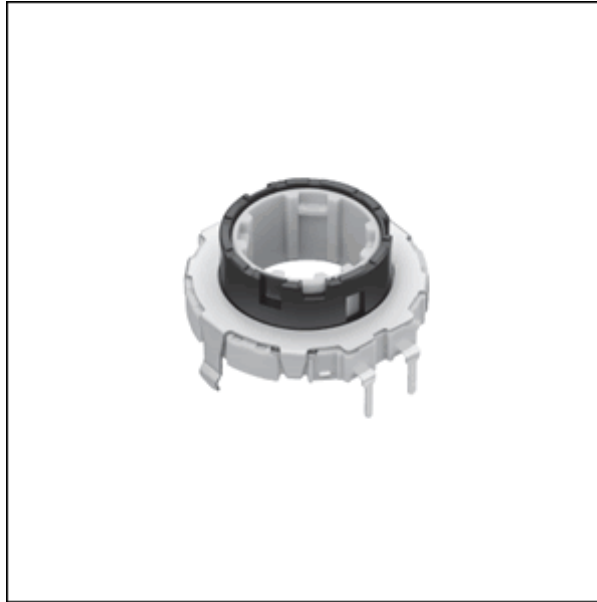

Dimensions

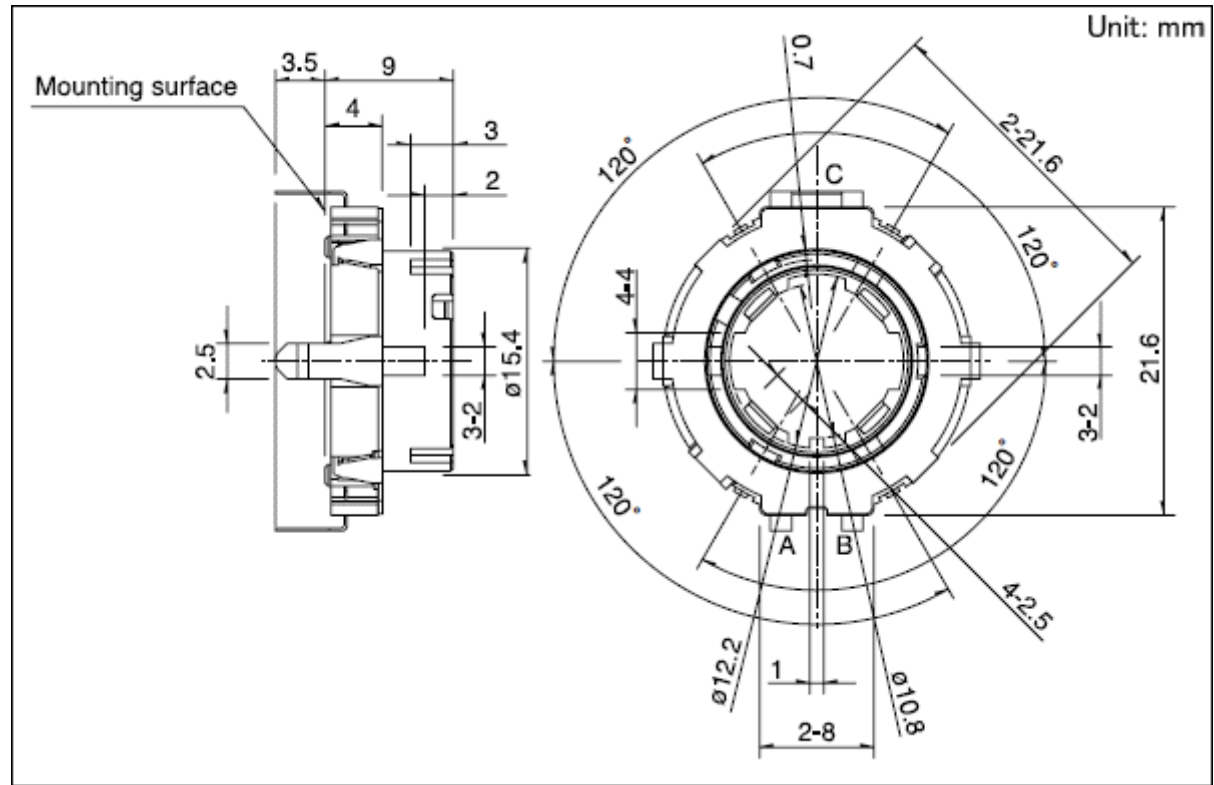

Mounting Hole Dimensions

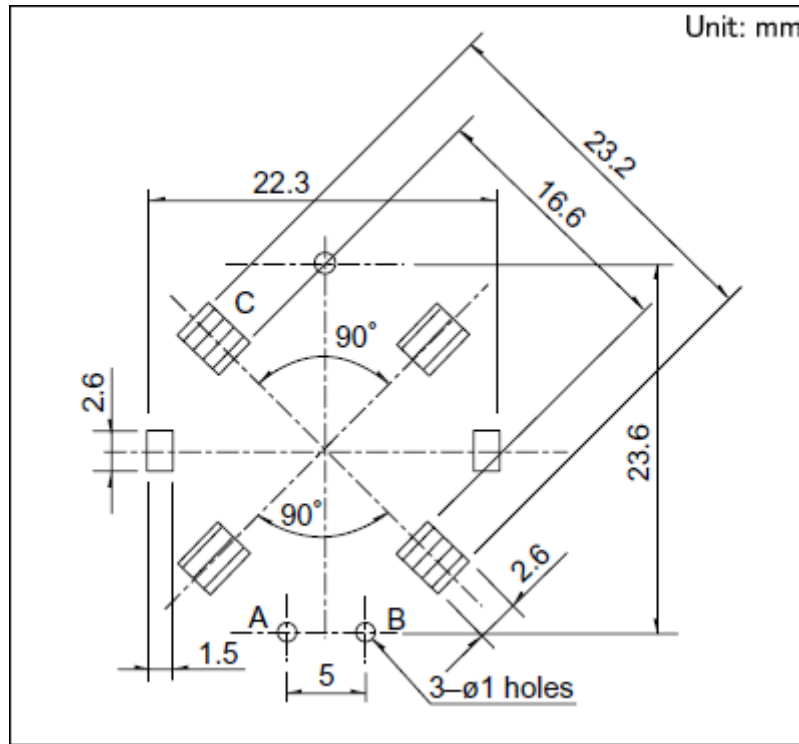

Do not wire the shaded area

Output Wave

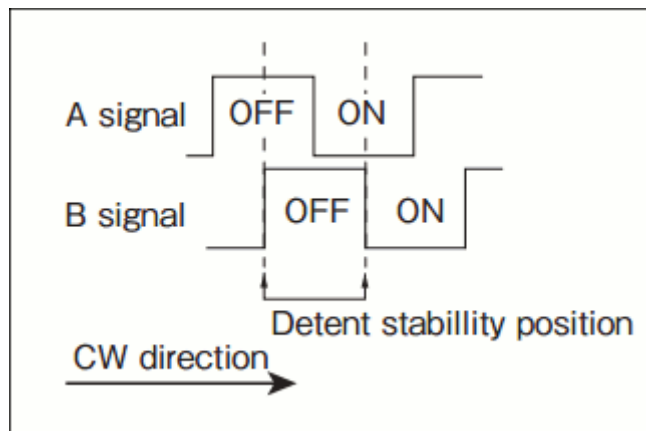

Sliding Noise

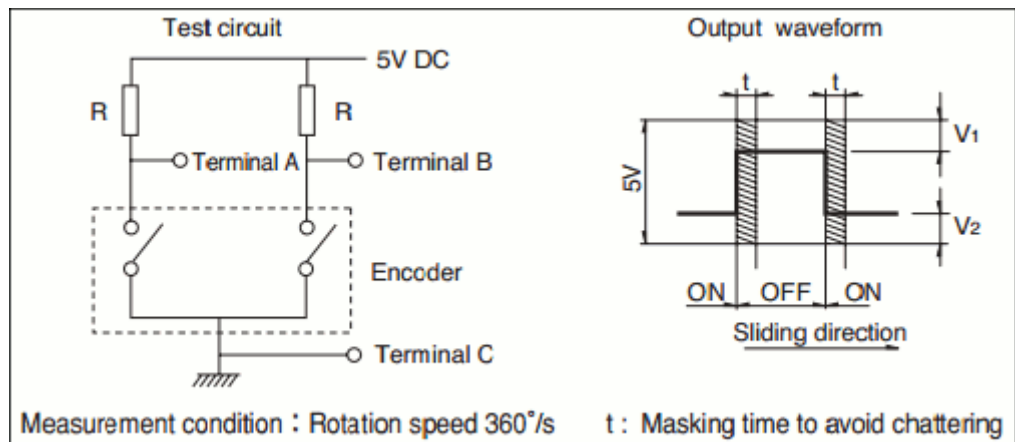

V1=V2=2.5V max.

At R = 5kΩ Chattering : 5ms max. Bounce : 5ms max.

Packing Specifications

Tray

Number of packages (pcs.)	1 case / Japan	600
	1 case / export packing	1,200
Export package measurements (mm)	364×508×192	

Soldering Conditions

Reference for Dip Soldering

Preheating	Soldering surfacetemperature	100°C max.
	Heating time	2 min. max.
Dip soldering	Soldering temperature	260±5°C
	Soldering time	5±1s

No. of solders	2 time max.
----------------	-------------

Reference for Hand Soldering

Tip temperature	350°C max.
-----------------	------------

Soldering time	3s max.
----------------	---------

No. of solders	1 time
----------------	--------

Notes are common to this series/models.

1. This site catalog shows only outline specifications. When using the products, please obtain formal specifications for supply.
2. Please place purchase orders per minimum order unit (integer).
3. This products can be used in vehicles.
Although these products are designed to perform over a wide operating temperature range, please ensure that you receive and read the formal delivery specifications before use.

X-ON Electronics

Largest Supplier of Electrical and Electronic Components

Click to view similar products for [Encoders](#) category:

Click to view products by [ALPS](#) manufacturer:

Other Similar products are found below :

[6-1393048-0](#) [6-1393048-5](#) [62B22-LP-030C](#) [63K25](#) [63K32](#) [63KS100](#) [63KS64](#) [63R100](#) [63R50-020](#) [63RS256-060](#) [700-09-36](#) [RE12D300-201-1](#) [1393047-3](#) [T101-5C2-111-M1](#) [T101-5C3-111-M1](#) [T101-5C4-111-M1](#) [385001M0439](#) [385001M0216](#) [V23401T8002B802](#) [E69-1E69DF10](#) [E69-FCA](#) [62B11-LP-100S](#) [62N11-P](#) [62S22-H9-120S](#) [62S30-L0-200C](#) [62V15-02-080S](#) [63K64](#) [63KS100-040](#) [63R64-050](#) [63RS64700-16-16](#) [V23401D3002B301](#) [3-1393048-1](#) [63KS128](#) [1-1879391-5](#) [GH65C11-N-SO](#) [62S15-M0-P](#) [63R64](#) [1393047-1](#) [E69-FCA02](#) [E69-FCA04](#) [E69-DF20](#) [E69-DF2](#) [63R50](#) [62F01-02-060S](#) [63RS50](#) [62B22-SPP-040S](#) [62B22-SPP-P](#) [62C1122-01-P](#)