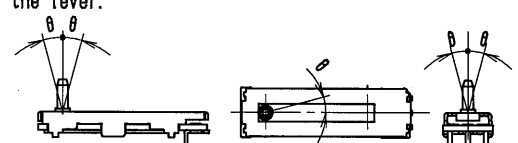
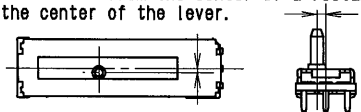
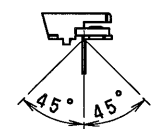

| CLASS No. | TITLE |
|--|---|
| | LINEAR POSITION SENSOR |
| 1. 一般事項 | General requirements |
| 1.1 使用温度範囲 | -30℃~+85℃ Operating temperature range |
| 1.2 保存温度範囲 | -40℃~+90℃ Storage temperature range |
| 1.3 試験条件 | Test conditions |
| <p>特に規定がない限り、試験及び測定は常温、常湿、常気圧の標準状態で行う。 (温度5~35℃、湿度 45~85%RH、気圧86~106kPa) 但し、判定に疑義を生じた場合は次の条件にて行うこと。 温度20±2℃、相対湿度60~70%RH、気圧86~106kPa Unless otherwise specified, a standard atmospheric conditions for measuring and testing shall be as follows.</p> <p>Ambient temperature : 5°C to 35°C Relative humidity : 45% to 85% Air pressure : 86kPa to 106kPa</p> <p>If there is any doubt about the results, measurements shall be made within the following limits.</p> <p>Ambient temperature : 20±2°C Relative humidity : 60% to 70% Air pressure : 86kPa to 106kPa</p> | |
| 1.4 その他 | 当仕様書内容に疑義が生じた場合は、両者協議の上規格を決定するものとする。 Others Customer and Supplier must work together to solve any problems that may be in the specifications. |
| 2. 外観・寸法 | Appearance・Dimensions |
| 2.1 外観 | 各部の仕上げは良好で機能上有害なサビ、キズ、フレ、メッキ不良及び剥離などがあるてはならない。 Appearance The appearance of the sensor shall be will done and not have any excessive rust, crack, poor plating and discolor in any parts. |
| 2.2 寸法 | 個別製品組立図による。 Dimensions This item shall be in accordance with the attached assembly drawing. |

| CLASS No. | TITLE |
|-------------|---|
| | LINEAR POSITION SENSOR |
| 3. 機械的性能 | Mechanical characteristics |
| 3.1 メカストローク | 個別製品組立図による。 Mechanical travel This item shall be in accordance with the attached assembly drawing. |
| 3.2 実使用 | 取付基準C点より1T側へ27.5mmの点をB点とする。 ストローク B点より3T側へ 30mmの点をA点とする。 B-A間を実使用ストロークとする。 Actual travel A REFERENCE POINT "C" is used for installing the sensor. The REFERENCE POINT "C" shall be a position in accordance with the attached assembly drawing. A POINT "B" shall be a position 27.5 mm from the REFERENCE POINT "C" toward term.1 side. A POINT "A" shall be a position 30 mm from the POINT "B" toward the term.3 side. The actual travel shall be the travel between the POINT "B" and the POINT "A" |
| 3.3 有効ストローク | B点より1T側へ0.5mmの点をB'点とする。 (リニアリティー A点より3T側へ0.5mmの点をA'点とする。 保証範囲) B'-A'間を有効ストロークとする。 Effective travel (Linearity specification applies to this travel) A POINT "B'" shall be a position of 0.5mm from the POINT "B" toward the term.1 side. A POINT "A'" shall be a position of 0.5mm from the POINT "A" toward the term.3 side. The effective travel shall be the travel between the POINT "B'" and the POINT "A'". |
| 3.4 作動力 | 0.25N以下(移動速度は5mm/秒とする。) Operating force 0.25N or less. Lever traveling speed : 5mm/s. |
| 3.5 レバーの | 揺動距離の両末端において枠上面より2mmの位置に、10Nの力を10秒間加え、 移動止強度 著しいガタ、及び接触不良を生じないこと。 Stopper strength After applying a static load of 10N to the lever at a point of 2mm from the frame-surface for 10 s. on condition that the lever position at both ends of the mechanical travel, the sensor shall not have intermittent contact or excessive mechanical damage. |
| 3.6 レバーの | レバーの押し方向および引張り方向に、10Nの力を10秒間加え 押し強度 レバーのガタ、及び破損等がなく、電氣的性能を満足すること。 Thrust and tensile lever After applying a thrust and a tensile static load of 10N to the lever from a parallel direction to the lever for 10 s., the sensor shall not have intermittent contact or excessive mechanical damages. |

ALPS ELECTRIC CO., LTD.

| | | | |
|----------|----------|----------|--------------------|
| APPD. | CHKD. | DSGD. | TITLE |
| M-2様(G) | M-2様 | M-2様 | 仕様書 SPECIFICATIONS |
| 11-07-28 | 11-07-28 | 11-07-28 | DOCUMENT NO. |
| 清 瀧 | 金谷(亨) | 清 水 | 5S321S0016 (1/6) |
| SYMB | DATE | APPD | CHKD |
| | | | DSGD |

| CLASS No. | TITLE |
|-----------|--|
| | LINEAR POSITION SENSOR |
| 3.7 | <p>レバーの横振れ 1.6mm P-P以下。 レバーに枠上面より2mmの位置に1Nの力を移動方向に対して直角に加えて測定する。</p> <p>Lever wobble 1.6mm p-p max. It shall be measured on condition that the lever is subjected to a static load of 1N at a point of 2mm from the frame-surface from a perpendicular direction to the lever.</p> |
| 3.8 | <p>レバーの傾き及びねじれ θは2度以下。 Lever Inclination and twist 2 degree max.</p>  |
| 3.9 | <p>レバーの片側0.5mm以下。 センターズレ 枠角穴中心に対するレバーセンターからのずれを片側ごと測定する。</p> <p>Lever deviation 0.5mm max. for each side. The deviation shall be measured from the center of a rectangular hole on the frame to the center of the lever.</p>  |
| 3.10 | <p>端子引張り強度 端子先端に10Nの力を30±1秒間、垂直に引っ張った後、端子の切れ又は緩みがなく、接触不良を生じないこと。</p> <p>Terminal tensile strength After applying a static load of 10N to the terminal for 30±1 s., the sensor shall not have intermittent contact or excessive mechanical damage such as loose or breakage.</p> |
| 3.11 | <p>端子曲げ強度 端子を指で45°曲げ元に戻す。これを1回とし左右1回行っ後、端子の切れ又は緩みがなく、接触不良を生じないこと。</p> <p>Terminal bending strength After bending the terminal 45° to right and left one time, the sensor shall not have intermittent contact or excessive mechanical damage such as loose or breakage.</p>  |

| CLASS No. | TITLE | | |
|--------------------------------|--|-----------|--------------------|
| | LINEAR POSITION SENSOR | | |
| 4. | <p>電気的性能 Electrical characteristics</p> <p>4.1 公称全抵抗値及び許容差 Nominal total resistance and tolerance 10kΩ±30% レバーを1T又は3Tの終端におき、抵抗器の端子1-3間の抵抗値を測定する。 It shall be measured between term.1 and term.3 on condition that the lever is pointed at either end of the term.1 or term.3.</p> <p>4.2 定格電力 0.05W 端子1と3の間に連続負荷することができる最大電力。 Rated power 0.05W This rated power shall be a maximum power, which the sensor is capable for being loaded continuously. The derating curve to the ambient temperature is shown as follows.</p> <p>4.3 定格電圧 D.C. 5V±0.25V (定格電圧を超える電圧での使用はお避けください) Rated voltage 5±0.25V D.C. No voltage exceeding the rated voltage to be applied.</p> <p>4.4 抵抗変化特性 B(電圧法にて測定) 但し B点にて 5±3% A点にて 95±3% A-B点間の出力差= 90±1% $\left(\frac{\text{A点出力電圧} - \text{B点出力電圧}}{\text{端子1-3間入力電圧}} \right) \times 100\%$ Resistance taper Linear "B" (SBSB5) Reference output voltage: 5±3% at the POINT "B" 95±3% at the POINT "A" POINT "A" - "B" : 90±1% $\left(\frac{\text{Output voltage at "A"} - \text{Output voltage at "B"}}{\text{Input voltage across Term.1-3}} \right) \times 100\%$</p> | | |
| ALPS ELECTRIC CO., LTD. | | | |
| APPD. | CHKD. | DSSD. | TITLE |
| M-2部(6) | M-2部 | M-2部 | 規格書 SPECIFICATIONS |
| '11-07-28 | '11-07-28 | '11-07-28 | DOCUMENT NO. |
| 清水 | 清水(宇) | 清水 | 5S321S0016 (2/6) |
| SYMB | DATE | APPD | CHKD |
| | | | |

| | |
|-----------|------------------------|
| CLASS No. | TITLE |
| | LINEAR POSITION SENSOR |

4.5 ヒステリシス ±0.4%
 当項目については、レバーと治具の取り付け状態、治具そのもののヒステリシスが問題となるため、疑義が生じた場合、アルプス製専用治具にて測定のこと。

Hysteresis
 ±0.4%
 The hysteresis shall be measured by using of the ALPS measuring equipments, because it is susceptible to measuring conditions.

4.6 リニアリティー 端子1-3間に定格電圧を加え、指定基準位置B、A点での実測出力値VB、VAを結んだ直線を理想直線とし、1-3端子間への印加電圧を100%としたときの理想直線に対する偏差を%で表す。
 測定は、B'→A'方向にレバーを移動して行うこと。

Linearity

The linearity shall be defined the percentage of variation of the output voltage to from the POINT "B" to the POINT "A" compared with the ideal straight line.
 The ideal straight line is drawn to connect output voltage points at the POINT "B" and the POINT "A" on each product.
 Measurement shall be made on lever movement from "B'" to "A'".

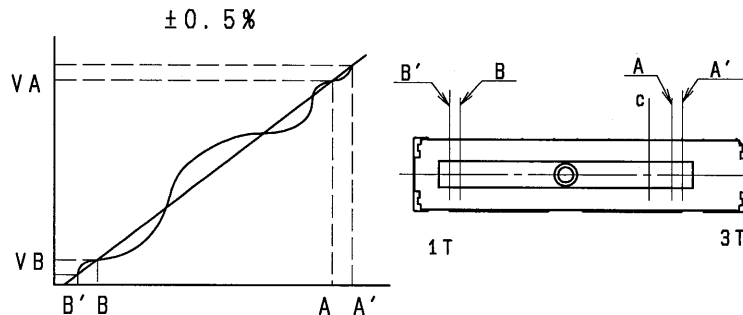

4.7 絶縁抵抗 端子-枠間 100MΩ以上
 D. C. 100Vの電圧を印加して測定。

Insulation resistance
 100M ohm minimum.
 (Between terminals and the frame)
 Measuring voltage: 100V D.C.

4.8 耐電圧 端子-枠間 A. C. 100V r. m. s. 1分間
 感度電流2mA (周波数 50/60Hz) 損傷、アークおよび、絶縁破壊を生じないこと。

Dielectric withstanding voltage
 100V A. C. 1 min.
 (Between terminals and the frame)
 Test voltage frequency: 50 or 60Hz. Detect current : 2mA.
 Without damage or arcing.

| | |
|-----------|------------------------|
| CLASS No. | TITLE |
| | LINEAR POSITION SENSOR |

5. 耐久性能 Endurance

5.1 無負荷稼働寿命 200,000サイクル以上
 全返抗値 : 初期値±15%
 リニアリティー: ±0.7%
 その他は、初期の機械的性能及び電気的性能を満足する事。
 無負荷にてレバーを64mm/秒の速さで1日5,000±200サイクルで稼働させる。

Endurance without load
 200,000 cycles
 specifications:
 Overall resistance: The Variation is ±15% against the Initial value.
 Linearity : ±0.7%
 Other items should be satisfied with Initial mechanical and electrical specification.

Test method:
 The lever shall be traveled from one end to the other end and returned to its original position extended over 90% or more of the actual travel without electrical load. And the moving contact shall be subjected 64mm/s. velocity for a total of 5000±200cycles for 24 hours.

5.2 はんだ耐熱 手はんだコテ先温度350℃以下、時間3秒以内にて、著しいガタ、接触不良を生じないこと。
 端子フランジ部にはんだが付かないよう注意願います。

Resistance to soldering heat
 After soldering, the sensor shall be no defect of electrical contact and no excessive mechanical damage.
 The soldering method shall be as follows:
 Bit temperature: 350°C max.
 Duration: 3 s.
 (The soldering shall be done by a soldering iron only and do not solder a flange part of the terminal.)

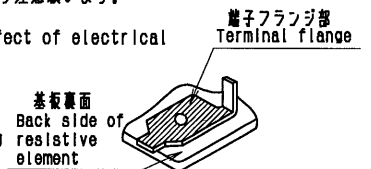

5.3 はんだぬれ性 端子先端から約2mmを250±5℃のはんだ槽に3秒間浸漬させる。はんだ浸漬面積の90%以上新しいはんだでぬれていること。をだし、破断面は除く。

Solderability
 About 2mm from the tip of terminal is soaked in the solder tank of 250±5°C for 3s.
 A new uniform coating of solder shall cover a minimum of 90% of the surface being immersed.
 Except for cut surface.

| | | | | | | | |
|-----------|------|----------|------|--------------------------------|--|--------------------|--|
| | | | | ALPS ELECTRIC CO., LTD. | | | |
| APPD. | | CHKD. | | DSBD. | | TITLE | |
| M-2 敏 (G) | | M-2 敏 | | M-2 敏 | | 規格書 SPECIFICATIONS | |
| 11-07-28 | | 11-07-28 | | 11-07-28 | | DOCUMENT NO. | |
| 清 湖 | | 松 本 (守) | | 清 水 | | 5S321S0016 (3/6) | |
| SYMB | DATE | APPD | CHKD | DSBD | | | |

| CLASS No. | TITLE |
|--------------------------|--|
| | LINEAR POSITION SENSOR |
| 5. 2 耐寒性 | -40±3℃にて240±8時間試験後、常温常湿中に1時間放置後測定する。 全抵抗値 : 初期値±20% その他は、初期の機械的性能及び電気的性能を満足する事。 |
| Low temperature storage. | Temperature : -40±3°C Storage time : 240±8 hours |
| Test condition: | Overall resistance: The Variation is ±20% against the Initial value. Other items should be satisfied with Initial mechanical and electrical specification. |
| Measuring condition: | After testing specimens in the specified temperature shall be stored in the standard atmospheric condition for one hour and measure these specimens after removing water from each specimen. |
| 5. 3 耐熱性 | 90±2℃にて240±8時間試験後、常温常湿中に1時間放置し測定する。 全抵抗値 : 初期値+5~-30% その他は、初期の機械的性能及び電気的性能を満足する事。 |
| High temperature storage | Temperature : +90±2°C Storage time : 240±8 hours |
| Test condition: | Overall resistance: The Variation is +5%/-30% against the Initial value. Other items should be satisfied with Initial mechanical and electrical specification. |
| Measuring condition: | After testing specimens in the specified temperature shall be stored in the standard atmospheric condition for one hour and measure these specimens. |
| 5. 4 耐湿性 | 60±2℃、相対湿度90~95%にて240時間放置後、常温常湿中に1時間放置後測定する。 全抵抗値 : 初期値+35~-5% その他は、初期の機械的性能及び電気的性能を満足する事。 但し、水滴は取り除き測定するものとする。 |
| Dump heat | Temperature : +60±2°C Relative humidity : 90 to 95% Storage time : 240 hours |
| Test condition: | Overall resistance: The Variation is +35%/-5% against the Initial value. Other items should be satisfied with Initial mechanical and electrical specification. |
| Measuring condition: | After testing specimens in the heat, they shall be stored in the standard atmospheric condition for one hour and measure these specimens after removing water from each specimen. |

| CLASS No. | TITLE | | | | | | | | | | | | | | | |
|--------------------------------------|---|-------------------------|--------------------|---------|---|--------|----------------|---|--|-------------------------|---|-------|----------------|---|--|-------------------------|
| | LINEAR POSITION SENSOR | | | | | | | | | | | | | | | |
| 5. 5 耐湿負荷 寿命特性 | 60±2℃、相対湿度90~95%にて定格電圧D. C. 5Vを1時間30分に加え30分切るサイクルを240±10時間繰り返し、常温常湿中に5時間放置後測定する。 全抵抗値 : 初期値±20% その他は、初期の機械的性能及び電気的性能を満足する事。 但し、水滴は取り除き測定するものとする。 | | | | | | | | | | | | | | | |
| Moisture resistance under load | Test method: Rated 5V D.C. shall be applied in a thermohydrostatic chamber of 60±2°C and 90 to 95%RH for 1 hour and 30 minutes and for 30 minutes without load. Repeat this cycle for 240±10 hours. Overall resistance: The Variation is ±20% against the Initial value. Other items should be satisfied with Initial mechanical and electrical specification. | | | | | | | | | | | | | | | |
| Measuring condition: | After testing specimens, they shall be stored in the standard atmospheric condition for more 5 hours and measure these specimens after removing water from each specimen. | | | | | | | | | | | | | | | |
| 5. 6 温度サイクル | 下記条件で5サイクル試験後、常温常湿中に1時間放置し、1時間以内に測定する。 全抵抗値 : 初期値±20% その他は、初期の機械的性能及び電気的性能を満足する事。 | | | | | | | | | | | | | | | |
| Change of temperature | Duration: 5 cycles | | | | | | | | | | | | | | | |
| Test method: | Subject specimens in the following conditions for 5 cycles. | | | | | | | | | | | | | | | |
| | <table border="1"> <thead> <tr> <th>段階 Step</th> <th>温度 Temperature</th> <th>時間 Time</th> </tr> </thead> <tbody> <tr> <td>1</td> <td>-40±3℃</td> <td>30分 30 min.</td> </tr> <tr> <td>2</td> <td>常温 The standard atmospheric condition</td> <td>10~15分 10 to 15 min.</td> </tr> <tr> <td>3</td> <td>85±2℃</td> <td>30分 30 min.</td> </tr> <tr> <td>4</td> <td>常温 The standard atmospheric condition</td> <td>10~15分 10 to 15 min.</td> </tr> </tbody> </table> | 段階 Step | 温度 Temperature | 時間 Time | 1 | -40±3℃ | 30分 30 min. | 2 | 常温 The standard atmospheric condition | 10~15分 10 to 15 min. | 3 | 85±2℃ | 30分 30 min. | 4 | 常温 The standard atmospheric condition | 10~15分 10 to 15 min. |
| 段階 Step | 温度 Temperature | 時間 Time | | | | | | | | | | | | | | |
| 1 | -40±3℃ | 30分 30 min. | | | | | | | | | | | | | | |
| 2 | 常温 The standard atmospheric condition | 10~15分 10 to 15 min. | | | | | | | | | | | | | | |
| 3 | 85±2℃ | 30分 30 min. | | | | | | | | | | | | | | |
| 4 | 常温 The standard atmospheric condition | 10~15分 10 to 15 min. | | | | | | | | | | | | | | |
| Overall resistance: | The Variation is ±20% against the Initial value. | | | | | | | | | | | | | | | |
| Other items should be satisfied with | Initial mechanical and electrical specification. | | | | | | | | | | | | | | | |
| Measuring condition: | After testing specimens, they shall be stored in the standard atmospheric condition for one hour, and they shall be measured within one hour later. | | | | | | | | | | | | | | | |
| ALPS ELECTRIC CO., LTD. | | | | | | | | | | | | | | | | |
| APPD. | CHKD. | DSGD. | TITLE | | | | | | | | | | | | | |
| M-2 渡 (G) 11-07-28 | M-2 渡 11-07-28 | M-2 渡 11-07-28 | 規格書 SPECIFICATIONS | | | | | | | | | | | | | |
| 渡 潤 | 渡 潤 | 渡 潤 | DOCUMENT NO. | | | | | | | | | | | | | |
| | | | 5S321S0016 (4/6) | | | | | | | | | | | | | |

| CLASS No. | TITLE |
|-----------|---|
| | LINEAR POSITION SENSOR |
| 5.7 耐振性 | <p>下記条件にて、初期の機械的性能及び電気的性能を満足する事。 振動条件：周波数 10~200Hz(掃引時間 20分) 加速度 43.1m/S² (最大振幅 10mm) 時間 X, Y, Z方向各2時間</p> <p>Vibration Vibration mode: 2 hours in each of 3 mutually perpendicular axes. (A total of 6 hours.) Vibration frequency: 10 to 200Hz(sweep:20minutes) Acceleration 43.1m/S² (maximum amplitude:10mm) After being subjected the above condition, sensor to meet items initial mechanical and electrical specification.</p> |
| 5.8 耐硫化性 | <p>40±2℃、相対湿度70~80%、硫化水素ガス濃度1±0.5ppm区で96時間放置後、常温常湿中24時間放置し測定する。 全抵抗値：初期値±20% その他は、初期の機械的性能及び電気的性能を満足する事。</p> <p>Resistance to sulfur Storage time: 96 hours Temperature: +40±2℃ Relative humidity: 70to80% Gas: hydrogen sulfide Density of the gas: 1±0.5ppm Test method: Overall resistance: The Variation is ±20% against the initial value. Other items should be satisfied with initial mechanical and electrical specification.</p> <p>Measuring condition: After testing specimens in the gas, they shall be stored in the standard atmospheric condition for 24 hours and measure these specimens.</p> |
| 5.9 低温動作 | <p>JIS C 5261 7.1項による。(試験温度:-40±3℃とする。) 全抵抗値：初期値±20% 作動力：0.25N以下</p> <p>Low temperature operation Temperature: -40±3℃ Storage time: 2 hours Overall resistance: The Variation is ±20% against the initial value. Operating force: 0.25N max.</p> |
| 5.10 耐衝撃性 | <p>下記条件にて、初期の機械的性能及び電気的性能を満足する事。 落下条件：衝撃加速度 980~1078m/s² 回数 6面、各10回 作用時間 6ms.</p> <p>Shock Peak acceleration: 980 to 1078m/S². Duration of pulse: 6 ms. Time: 10 shocks in each direction along three mutually perpendicular axis of the specimens.</p> <p>The rest of characteristics, item initial mechanical and electrical specification.</p> |

| CLASS No. | TITLE | | | | |
|---|--|------------------------------------|---|---------------------------------|---|
| | LINEAR POSITION SENSOR | | | | |
| 6. 注意事項 Note | <p>6.1 端子部のはんだ付けについて (但し、*1はリード端子品を除く) *1 端子部のはんだ付けは、片面のプリント配線基板やフレキシブル基板をご使用下さい。</p> <div style="text-align: center;"> </div> <p>・片面スルーホール基板の使用や、リード線を直接はんだ付けすることは避けてください。 ・図のようにP, W, Bの上面に はんだ付けをする配線は、お避け下さい。 Please avoid soldering on upper surface of P.W.B. as shown</p> <div style="text-align: center;"> </div> <p>*2フランジ部やハトメ穴部にはんだが流れ込むと、熱やはんだの応力により抵抗体と端子の接触部がゆるみ接触不安定になることがあります。</p> <p>Soldering terminals *1 Rigid or flexible single sided P.C.B. to be used for soldering terminals. Avoid using double sided through-hole P.C.B. or direct soldering to the terminals. (*1 Not applicable to lead terminal type.) *2 Use protection material to the flange so that solder does not penetrate to the flange portion. If flange portion or eyelet is subjected to solder, Intermittent contact may occur due to loose terminal caused by heat effect.</p> <div style="text-align: center;"> </div> <p>基板に挿入される金属足ははんだ付けしてご使用願います。 Solder all metal inserted fixing including terminals & metal lugs into a substrate.</p> | | | | |
| <p>ALPS ELECTRIC CO., LTD.</p> <table border="1"> <tr> <td>APPD. M-2部(6) 11-07-28 清水</td> <td>CHKD. M-2部 11-07-28 佐々木(幸)</td> <td>DSSD. M-2部 11-07-28 清水</td> <td>TITLE 規格書 SPECIFICATIONS DOCUMENT NO. 5S321S0016 (5/6)</td> </tr> </table> | | APPD. M-2部(6) 11-07-28 清水 | CHKD. M-2部 11-07-28 佐々木(幸) | DSSD. M-2部 11-07-28 清水 | TITLE 規格書 SPECIFICATIONS DOCUMENT NO. 5S321S0016 (5/6) |
| APPD. M-2部(6) 11-07-28 清水 | CHKD. M-2部 11-07-28 佐々木(幸) | DSSD. M-2部 11-07-28 清水 | TITLE 規格書 SPECIFICATIONS DOCUMENT NO. 5S321S0016 (5/6) | | |

| | | |
|-----------|-------|------------------------|
| CLASS No. | TITLE | LINEAR POSITION SENSOR |
|-----------|-------|------------------------|

6.2 接続インピーダンスについて

当センサは、図1のように、その出力端子をマイコンのA/Dポートに直接接続して使う事を前提に製作されています。つまり、接続インピーダンスの値はメガオームオーダーを前提とし、センサ内部の接触抵抗をかなり高めめに設定しています。よって、図2のような回路でご使用になる場合は、接続インピーダンスが1MΩ以下にならないように、ご配慮願います。

Load Impedance

Since this sensor is designed the output to be connected directly to the A/D port, the load impedance to be meg ohm level, so the contact resistance of the sensor is at rather high. Please refer to Fig-1. So when you use it in the circuit like Fig-2, please make sure that impedance should be over than 1M ohm.

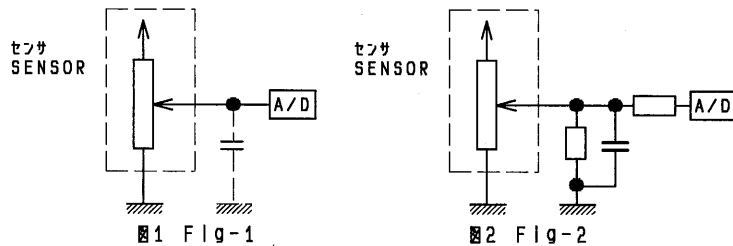

6.3 ノイズ対策について

センサからのデータ取り込みの際、まれに発生する取り込みミスや、外部ノイズの飛び込みと見られる、再現性の無いノイズの影響を最少限に抑えるため、ソフト上で以下のような配慮をお願いします。

- 例)データの取り込みは、必ず数回行い平均を取る。
- 取り込みミスと見られるデータは無効にするような判断をさせる。
- 疑義が発生した場合、再取り込みをする。
- 上記内容を組み合わせる、等。

Noise protection

We would like you to take the mentioned below into consideration in your software to minimize influence of non-reproducible noise and missing data from the sensor which might occur by any chance.

- ex) Getting data from the sensor should be conducted multi-times, then take an average.
- Suspected data must be checked if that they are invalid, then take data again if necessary.
- Combination of these actions, etc.

| | | |
|-----------|-------|------------------------|
| CLASS No. | TITLE | LINEAR POSITION SENSOR |
|-----------|-------|------------------------|

6.4 レバー駆動方法について

当センサのレバーは、しゅう動子(ブラシ)を保持するしゅう動子受けと一体になっており、異常な負荷が加わると性能に影響を及ぼします。レバー駆動時には、下図のように、ねじり方向や傾き方向に異常な負荷が加わらないよう、レバー長さの範囲内でストローク方向に駆動させてください。

Actuating lever

If an excessive impact or pressure is applied to the lever, electrical characteristics may be affected because the lever is a part of wiper holder. Twisting or Inclination of the lever to be avoided, move the lever within the specified travel in actuating the lever as shown in the figure below.

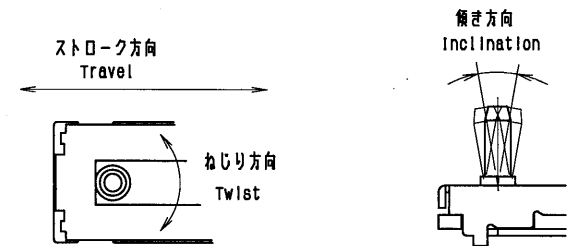

| | | | | | | | | |
|------|------|------|------|------|--------------------------------|----------|----------|--------------------|
| | | | | | ALPS ELECTRIC CO., LTD. | | | |
| | | | | | APPD. | CHKD. | DSGD. | TITLE |
| | | | | | M-2 渡 (G) | M-2 渡 | M-2 渡 | 規格書 SPECIFICATIONS |
| | | | | | 11-07-28 | 11-07-28 | 11-07-28 | DOCUMENT NO. |
| | | | | | 渡 野 | 渡 本(守) | 渡 水 | 5S321S0016 (6/6) |
| SYMB | DATE | APPD | CHKD | DSGD | | | | |

| | | | |
|--|-------------------|-------|------------------|
| USED ON | 32 mm TRAVEL TYPE | NAME | RESISTANCE TAPER |
| | | TITLE | SPECIFICATIONS |
| ALPS ELECTRIC CO., LTD. 1-7 YUKIGAYA OTSUKA-CHO OTA-KU TOKYO JAPAN | | ALPS | |

TAPERED CURVE: ALPS "B"

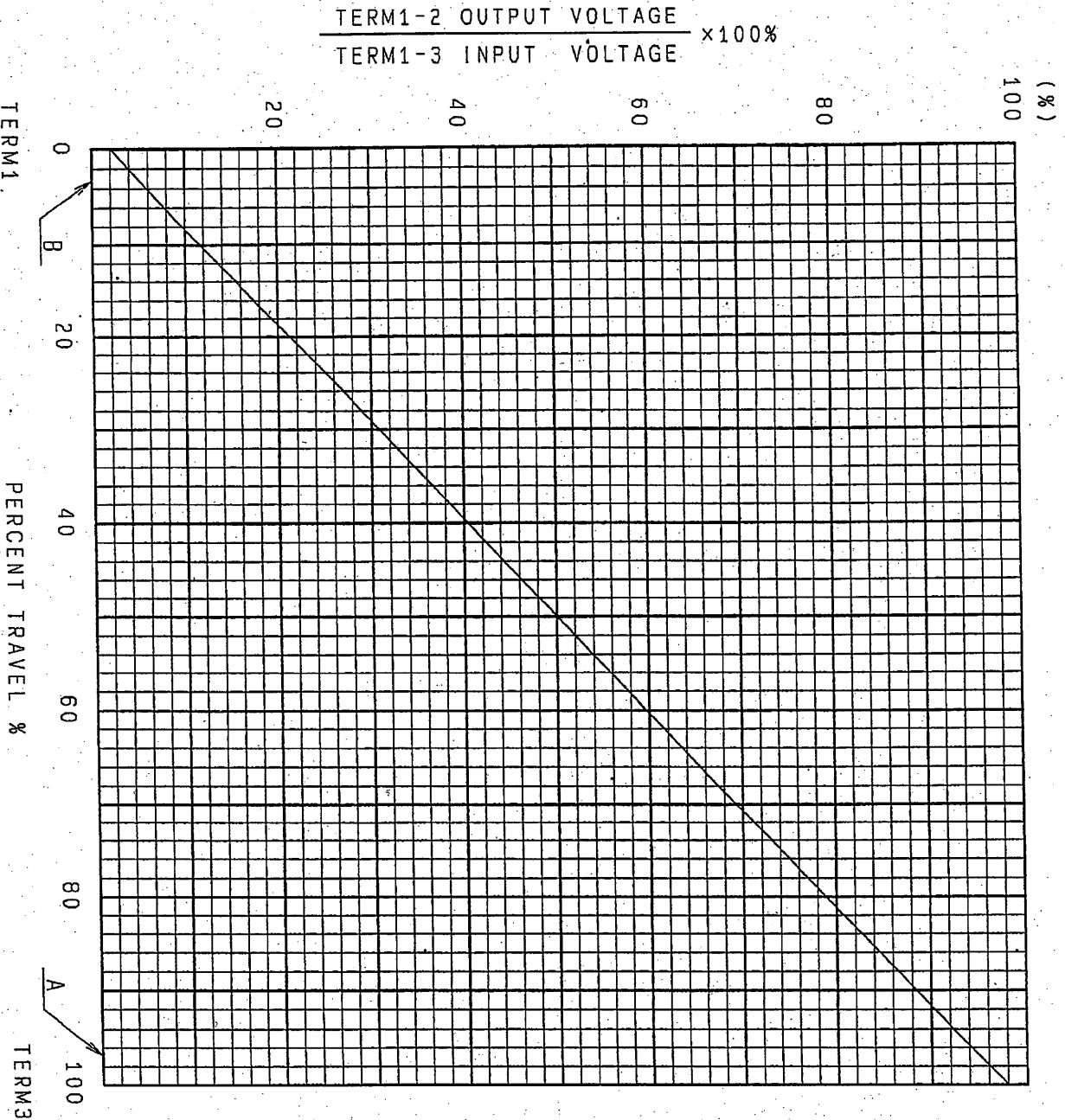

NOTES: PERCENT VOLTAGE
CHECK POINT

POINT 'B' 3.1% (1mm) TRAVEL FROM TERM. 1
POINT 'A' 96.9% (31mm) TRAVEL FROM TERM. 1

TOLERANCE

| | | | | | |
|-------|----------|-------|-------|-------|------------------|
| SYMB. | DATE. | APPD. | CHKD. | DSGD. | NAME |
| ORG | 95-02-07 | Y. O | K. M | R. O | RESISTANCE TAPER |
| | | | | | DOCUMENT NO. |
| | | | | | SBS85 |

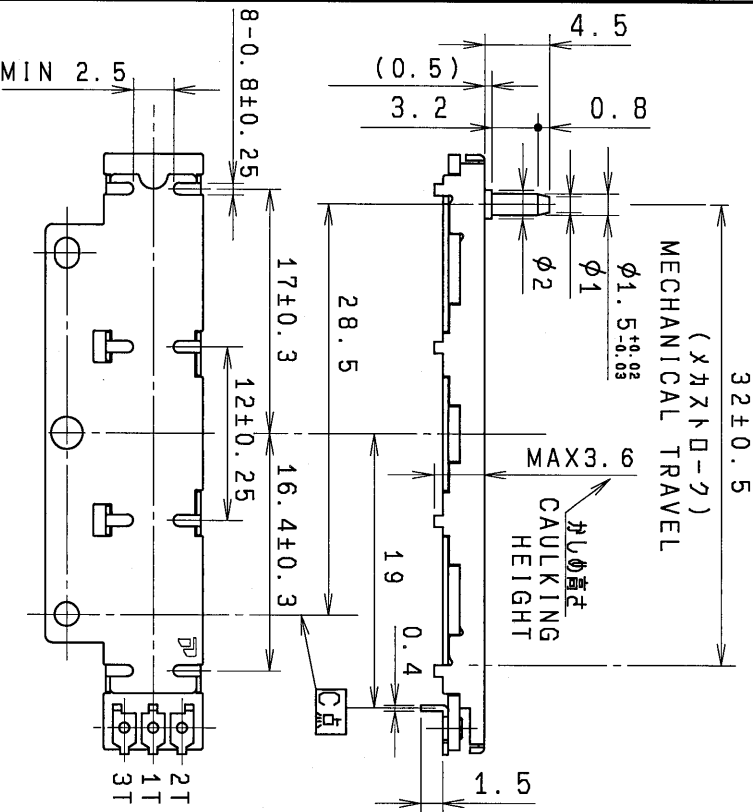
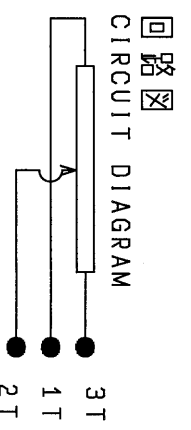
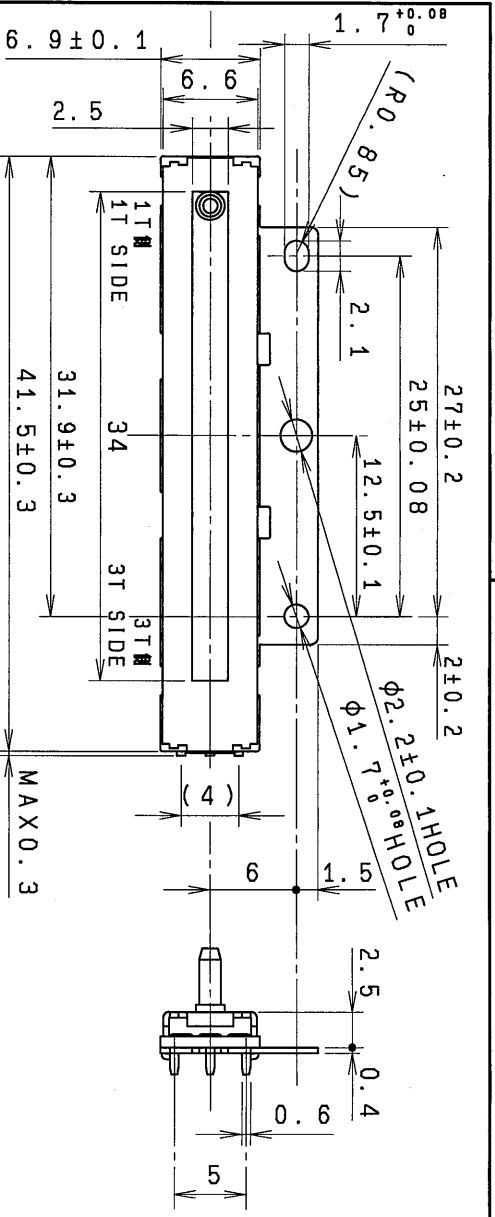

推奨取付寸法 挿入側より
MOUNTING HOLE DETAIL
(RECOMMENDATION)
VIEW FROM MOUNTING SIDE.
19±0.1

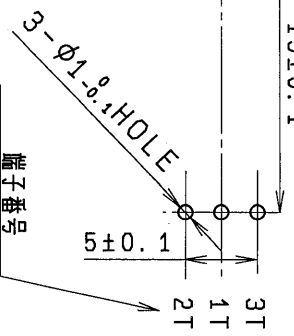

注記
1. C点は取付基準点である。
2. 推奨取付寸法は、取付基板設計用の参考寸法である。

NOTE
1. POINT 'C' IS A REFERENCE POINT FOR MOUNTING.
2. MOUNTING HOLE DATEIL SHOWS REFERENCE DIMENTION FOR P.C. BOARD DESIGNING.

TERMINAL NO.

| | |
|--|------|
| 指定なき部分の許容差 TOLERANCES UNLESS OTHERWISE SPEC | |
| $L \leq 10$ | ±0.3 |
| $10 < L \leq 100$ | ±0.5 |
| $100 < L$ | ±0.8 |
| 角度 | |
| ANGULAR DIMENSION | ±5° |

| | | | |
|--------------------------------|------------------------|----------------------|--------|
| PART NO. | NAME | MATERIAL NAME / CODE | FINISH |
| ALPS ELECTRIC CO., LTD. | | | |
| DSGD. | SCALE | NO. | |
| Y. SHIMIZU 2011-11-10 | 2 : 1 | | |
| CHKD. | TITLE | | |
| T. SASAKI 2011-11-10 | LINEAR POSITION SENSOR | | |
| APPD. | DOCUMENT NO. | | |
| S. MIZOBUCHI 2011-11-10 | 53215GJ25(0) | | |
| SYMB | DATE | APPD | CHKD |
| | | DSGD | DSGD |

X-ON Electronics

Largest Supplier of Electrical and Electronic Components

Click to view similar products for [Board Mount Motion & Position Sensors](#) category:

Click to view products by [ALPS](#) manufacturer:

Other Similar products are found below :

[6SS4](#) [F02008062](#) [9970-090-9J-SA](#) [AS5270B-HMFM](#) [MB060-N-221-A02](#) [MB090-N-221-A02](#) [RDC506017A](#) [RD602B014B](#) [RDC1032A0C](#)
[RD611A009C](#) [RD602B016A](#) [WI-27-102](#) [WI-27-503](#) [WI-27-104](#) [WI-27-202](#) [WI-27-502](#) [WI-27-203](#) [WI-27-103](#) [S18-L262B-2](#)
[MLX90340LDC-AAA-000-RE](#) [RD1010028A](#) [RDC1032A0F](#) [KTH5763AQ3DNE](#) [VCP1611](#) [VCP1615](#) [APS00B](#) [MT6816CT-STD](#)
[MT6816CT-ACD-R](#) [MT6701CT-ACD](#) [XYC-PIR223W-S0](#) [XYC-PIR423D-D0](#) [XYC-TH4616-S1](#) [XYC-PIR203B-S0](#) [XYC-PIR214D-D0](#)
[XYC-PIR223Z-S0](#) [XYC-PIR226Z-S0](#) [XYC-PIR203Z-S0](#) [XYC-PIR224S-S1](#) [XYC-PIR244D-D0](#) [XYC-PIR224D-S0](#) [GH1496BUA](#) [GH1187](#)
[BISS0001DRG](#) [MLX90365KGO-ABD-000-RE](#) [SCA3300-D01-PCB](#) [EVW-ADF001B14](#) [MLX90316KDC-BCG-200-TU](#) [MLX90316KDC-](#)
[BDG-100-RE](#) [ZSBG446671](#) [MTS-360-1A-C0000-ERA360-05E](#)