

RS □ □ 1 Super Slide™ (Standard Type)

Solderable with auto dipping and available in a wide variety

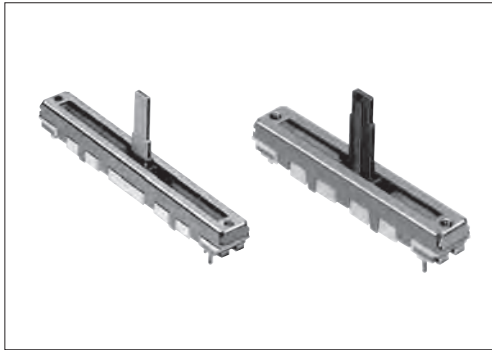

Typical Specifications

Items	Specifications
Total resistance tolerance	±20%
Maximum operating voltage	Please see P.355
Operating force	0.3 to 2.5N
Operating life	15,000 cycles
Operating temperature range	-25°C to +70°C

Product Line

Insulated lever

Number of resistor elements	Travel (mm)	Lever types	Length of lever L ₁ (mm)	Total resistance (k Ω)	Resistance taper	Detent	Mounting plate	Minimum order unit (pcs.)		Products No.	Drawing No.
								Japan	Export		
Single-unit	15	J-1	5	10	1B	Without	Without	700	2,800	RS151111J026	1
	20									RS201111J011	2
	30	A	10					600	2,400	RS301111A01G	3
	45	B						1,300	1,300	RS451111B010	4

Metal lever

Number of resistor elements	Travel (mm)	Lever types	Length of lever (L ₁) (mm)	Total resistance (k Ω)	Resistance taper	Detent	Mounting plate	Minimum order unit (pcs.)		Products No.	Drawing No.
								Japan	Export		
Single-unit	15	9-1	10	10	1B	Without	With	700	2,800	RS151111A9A03	5
	20									RS201111A9A03	6
	30							600	2,400	RS301111A9012	7
	45							1,300	1,300	RS451111A900F	8
	60							900	900	RS601111YA9A07	9
Dual-unit	30	4	20	10	1B	Without	With	600	2,400	RS30112A900S	10
	45							1,150	1,150	RS45112A400G	11
	60							900	900	RS60112A6A0C	12

Note

Other varieties are also available. Refer to "Other Specifications" (P.355, 356).

Packing Specifications

Tray

Product No.	Number of resistor elements	Number of packages (pcs.)		Export package measurements (mm)
		1 case /Japan	1 case /export packing	
RS151 RS201	Single-unit	700	2,800	518×378×422
RS301	Single-unit/ Dual-unit	600	2,400	
RS451	Single-unit	1,300	1,300	529×373×273
	Dual-unit	1,150	1,150	
RS601	Single-unit/ Dual-unit	900	900	

Refer to P.355 for other specifications.
Refer to P.356 for configuration details.
Refer to P.357 for ordering products not listed.
Refer to P.383 for soldering conditions.

RS 1 Super Slide™ (Standard Type)

Dimensions

Unit:mm

No.	Style	PC board mounting hole dimensions (Viewed from mounting side)
1		
2		
3		
4		
5		

The length of Lever (L₁) can be customized. Refer to P.356 for details.

Dimensions

Unit:mm

No.	Style	PC board mounting hole dimensions (Viewed from mounting side)
6		
7		
8		
9		
10		

The length of Lever (L₁) can be customized. Refer to P.356 for details.

Rotary Potentiometers
 Slide Potentiometers
 General-use
 Mixer

RS □ □ 1 Super Slide™ (Standard Type)

Dimensions

Unit:mm

No.	Style	PC board mounting hole dimensions (Viewed from mounting side)
11		
12		

The length of Lever (L₁) can be customized. Refer to P.356 for details.

Rotary
Potentiometers

Slide
Potentiometers

General-use

Mixer

Super Slide™ (Standard Type) / Other Specifications

In addition to the Product Line, we accommodate the following specifications. Combinations not included in the Product Line are treated as semi-standard products.

Travel Distance Variety

Travel (mm)	15	20	30	45	60
-------------	----	----	----	----	----

Total Resistance Variety

Total resistance (k Ω)	10	20	50	100	200
------------------------	----	----	----	-----	-----

Resistance Taper

Resistance taper	1B	3B	4B	10A	15A
------------------	----	----	----	-----	-----

Note

DC (10V DC) is also available. (Tapped types are not available)

Rated Power

Travel	Single-unit		Dual-unit	
	1B	4B, 10A, 15A	1B, 3B	4B, 10A, 15A
15mm	0.05W	0.025W	0.025W	0.012W
20mm	0.1W	0.05W	0.05W	0.025W
30mm	0.2W	0.1W	0.1W	0.05W
45mm	0.25W	0.125W	0.125W	0.06W
60mm	0.2W	0.1W	0.2W	0.1W

Maximum Operating Voltage

Travel	Single-unit		Dual-unit	
	1B	4B, 10A, 15A	1B, 3B	4B, 10A, 15A
15mm	100V AC, 10V DC	50V AC, 10V DC	100V AC, 10V DC	50V AC, 10V DC
20mm				
30mm				
45mm	200V AC, 10V DC	150V AC, 10V DC	200V AC, 10V DC	150V AC, 10V DC
60mm				

Terminal Layout / Circuit Diagram (Viewed from Mounting Side)

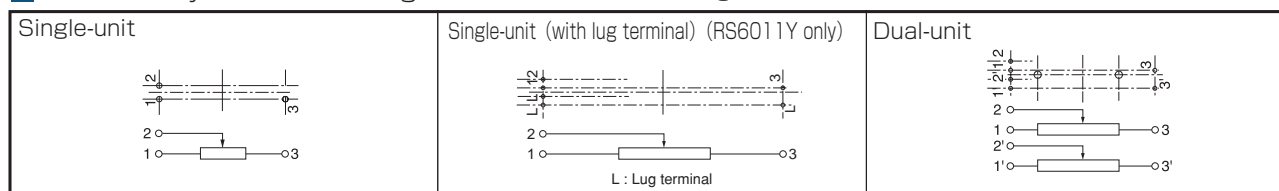

Note

Marked are specifications recommended by Alps Alpine.

Rotary
Potentiometers

Slide
Potentiometers

General-use

Mixer

Refer to P.357 for ordering products not listed.

Super Slide™ (Standard Type) / Other Specifications

In addition to the Product Line, we accommodate the following specifications. Combinations not included in the Product Line are treated as semi-standard products.

Lever Types

Metal lever		Insulated lever		Unit:mm					
Code	Dimensions	Code	Dimensions						
9-2	<p>t=1.2</p> <table border="1"> <tr><td>L₁</td></tr> <tr><td>5</td></tr> </table>	L ₁	5	J-1	<p>t=2</p> <table border="1"> <tr><td>L₁</td></tr> <tr><td>5</td></tr> </table>	L ₁	5		
L ₁									
5									
L ₁									
5									
9-1	<p>t=1.2</p> <table border="1"> <tr><td>L₁</td></tr> <tr><td>10</td></tr> </table>	L ₁	10	A	<p>t=2</p> <table border="1"> <tr><td>L₁</td></tr> <tr><td>10</td></tr> <tr><td>15</td></tr> </table>	L ₁	10	15	
L ₁									
10									
L ₁									
10									
15									
6	<p>t=1.2</p> <table border="1"> <tr><td>L₁</td></tr> <tr><td>15</td></tr> <tr><td>20</td></tr> </table>	L ₁	15	20	B	<p>t=2</p> <table border="1"> <tr><td>L₁</td></tr> <tr><td>10</td></tr> <tr><td>15</td></tr> </table>	L ₁	10	15
L ₁									
15									
20									
L ₁									
10									
15									
4	<p>t=1.2</p> <table border="1"> <tr><td>L₁</td></tr> <tr><td>15</td></tr> <tr><td>20</td></tr> </table>	L ₁	15	20	C	<p>t=2</p> <table border="1"> <tr><td>L₁</td></tr> <tr><td>10</td></tr> <tr><td>15</td></tr> </table>	L ₁	10	15
L ₁									
15									
20									
L ₁									
10									
15									

Corresponding Specifications

Dust cover	Available
Tap	Available (Only the center-positioned)

Note

Marked are specifications recommended by Alps Alpine.

Super Slide™ (Standard Type) / Ordering Products Not Listed

In addition to the Product Line, we accommodate the following specifications. Combinations not included in the Product Line are treated as semi-standard products. Please refer to the notation example below.

Sample Part Number

R S 6 0 1 1 Y — **J 1 0 5** — **C 0** — **P 0** — **B 1 0 3**

Travel

Code	Travel (mm)	Code	Travel (mm)
15	15	45	45
20	20	60	60
30	30	—	—

Number of resistor elements

Code	Number of resistor elements
1 (Enter "Y" for 60 mm travel)	Single
2	Dual

Lever type / Length of lever (mm)

Insulated lever

Code	Configuration	Length
J1	J-1	5
OA	A	10
		15
OC	C	10
		15
OB	B	10
		15

Metal lever

Code	Configuration	Length
91	9-1	10
92	9-2	5
04	4	15
		20
06	6	15
		20

Length of operation unit

If the length is less than 10 mm, add a "0" before the number.
(e.x., 5 mm length= "05")

Detent

Code	Detent
C0	Without
C1	Center

Mounting plate

Code	Mounting plate
P0	Without
P1	With

Resistance taper

Code	Resistance taper
A	15A
B	1B
D	10A
W	4B
V	3B

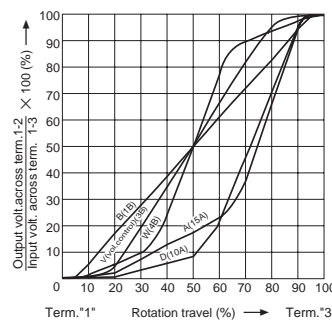

Note

Marked are specifications recommended by Alps Alpine.

Rotary
Potentiometers

Slide
Potentiometers

General-use









Mixer

Total resistance

Code	Total resistance (kΩ)	Code	Total resistance (kΩ)
103	10	104	100
203	20	204	200
503	50	—	—

Slide Potentiometers

List of Varieties

Type		Standard Type			Master Type
Series		Super Slide™	Slim Slide™ (Slim 4)	Compact Reflow Type	K Fader
		RS □□ 1	RS □□ H	RS08U	RS □□ K
		Single-unit/Dual-unit	Single-unit/Dual-unit	Single-unit	Single-unit/Dual-unit
Photo					
Travel (mm)		15, 20, 30, 45, 60	15, 20, 30	8	60, 100
Direction of lever		Vertical		Horizontal	Vertical
Lever material		Metal / Resin	Resin	Resin	Metal
Operating temperature range		-25°C to +70°C		-10°C to +70°C	-10°C to +60°C
Operating life		15,000 cycles	10,000 cycles		100,000 cycles (Standard) 300,000 cycles (CP)
Available for automotive use		○	—	—	—
Life cycle (availability)					
Electrical performance	Total resistance (k Ω)	10, 20, 50, 100, 200	5, 10, 20, 50, 100, 200, 250	10	10, 50, 100 (Standard) 10 (CP)
	Resistance taper	10A, 15A, 1B, 3B, 4B	15A, 1B, 3B	1B	15A, 1B
	Rated Power	Please see P.355	Please see P.362	0.025W	0.25W
	Insulation resistance	100MΩ min. 250V DC	Dual-unit: 100MΩ min. 250V DC	100MΩ min. 100V DC	100MΩ min. 250V DC
	Voltage proof	300V AC for 1 minute	Dual-unit: 300V AC for 1 minute	100V AC for 1 minute	250V AC for 1 minute
	Center-taps	Without / With		Without	
Mechanical performance	Operating force	0.3 to 2.5N	0.6 ^{+0.5} _{-0.4} N	0.17±0.15N	Please see P.368
	Center detent	Without / With		Without	
	Stopper strength	50N	30N	5N	100N
	Lever push-pull strength	50N	30N	5N	100N
	Lever wobble (mm) ※ Both sides	$\frac{2(2 \times L)}{20}$	1.6 max.	—	$\frac{2(2 \times L)}{25}$
	Detent slip-out force	Operating force + (0.2 to 2N)	Operating force + 0.3 ^{+0.5} _{-0.25} N	—	—
	Lever deviation (mm) ※ One side	0.5 max.	—	—	0.5 max.
Terminal style		Insertion		Reflow	Lead (Standard) Connector (CP)
Page		351	358	364	365

Slide Potentiometers Soldering Conditions	383
Potentiometer Cautions	384
Potentiometers Measurement and Test Methods	386
Potentiometers Resistance Taper	388

Notes

- "L" in the "Lever Wobble" column of the above table indicates the length of lever.
- RS □□  □□ indicates travel.
- Indicates applicability to some products in the series.

Slide Potentiometers / Soldering Conditions

Reference for Manual Soldering

Series	Tip temperature	Duration of Soldering time	No. of solders
RS□□1, RS□□H, RS08U, RS□□K (Standard), RS□□N, RS6011□P, RS□□N1□M, RSA0K1□V (Motor terminal)	350°C max.	3s max.	1 time

Reference for Dip Soldering

Series	Preheating		Dip soldering		Number of soldering
	Soldering surface temperature	Heating time	Soldering temperature	Soldering time	
RS□□1, RS□□H, RS□□N, RS6011□P, RS□□N1□M	100°C max.	1 min. max.	260°C	5s max.	1 time

Example of Reflow Soldering Condition

Temperature profile

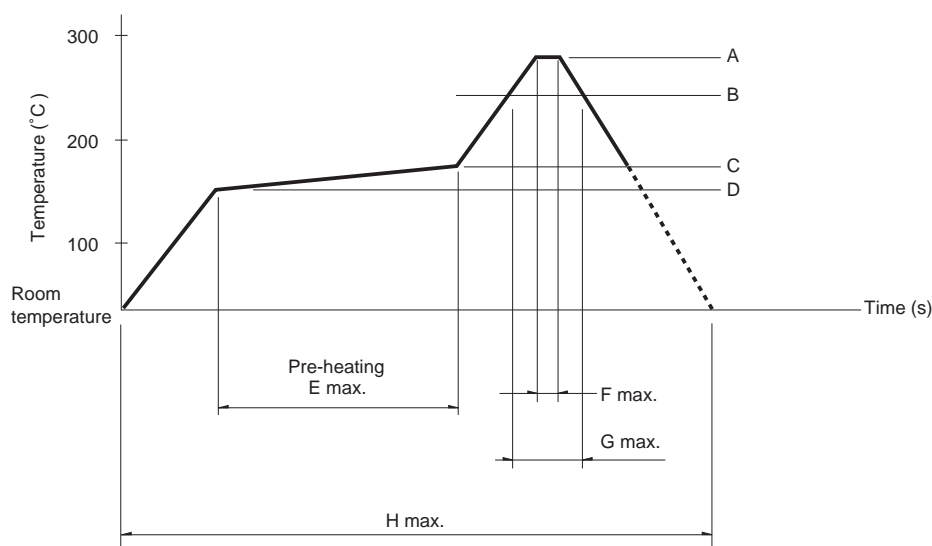

Series	A	B	C	D	E	F	G	H	No. of reflows
RS08U	250°C	200°C	150°C	150°C	2 min.	3s	40s	4 min.	1 time

Notes

1. When using an infrared reflow oven, solder may sometimes not be applied. Be sure to use a hot air reflow oven or a type that uses infrared rays in combination with hot air.
2. The temperatures given above are the maximum temperatures at the terminals of the products when employing a hot air reflow method. The temperature of the PC board and the surface temperature of the products may vary greatly depending on the PC board material, its size and thickness. Ensure that the surface temperature of the products does not rise to 250°C or greater.
3. Conditions vary to some extent depending on the type of reflow bath used. Be sure to give due consideration to this prior to use.

X-ON Electronics

Largest Supplier of Electrical and Electronic Components

Click to view similar products for [Slide Potentiometers](#) category:

Click to view products by [ALPS](#) manufacturer:

Other Similar products are found below :

[M22](#) [SS-4928](#) [RSA0K11A901L](#) [RA6020F-10-20D1-B50K](#) [RA4520F-10-20D1-B50K](#) [X22205CAAF](#) [RSA0N11B9A03](#) [448XC2103BDN](#)
[K22208EAAG](#) [PS15-10PC1BR10K](#) [3048L-2-503](#) [MFP 211-N](#) [CDE23N-60-B10K](#) [CDE23N-60-B1K](#) [CDE23N-60-B50K](#) [1825160-1](#)
[1825161-2](#) [1825257-1](#) [1825259-2](#) [1825261-2](#) [PS100-2B1AR10K](#) [1825255-5](#) [PTA6044-2015CPB103](#) [PTA6044-2015CPB104](#) [PTA6044-](#)
[2015CPA103](#) [PTA6044-2015CPA104](#) [PS100-1B1BR10K](#) [PTA3044-2015CPB504](#) [RS15H113CA05](#) [PS20-10PC1BR10K](#) [RS08U11AZ001](#)
[RA4520F-10-20D1-B1K](#) [PTL30-15R0-104B2](#) [PTE60-202B-102B2](#) [PTA6044-2015DPB103](#) [RA6020F-10-20D1-B100K](#) [RA6020F-10-15F2-](#)
[B2K](#) [RA4543F-20-15D1-B10K-01](#) [RA3043F-20-10EB1-A100K](#) [RA6043F-20-10EB1-A5K](#) [RA6020F-10-20D1-B250K](#) [RA6020F-10-15F2-](#)
[B5K](#) [RA6020F-10-15F2-B1K](#) [RA00B1MF-10-08T1-JISB10K-016](#) [RA60K1F-10-13D1-B100K-011](#) [RA3043F-20-10EB1-A50K](#) [RA4520F-](#)
[10-20D1-B5K](#) [SX254](#) [CDE23N-60-B5K](#) [CDE91N-60-B100K](#)