

Spring Contact SCTA_D Series (With Insulation Coating)

Dimensions (W × D)	1.45 × 1.45mm
Height in use	1.45 to 1.75mm
Travel	0.5mm
Mounting type	Surface mounting type
Mounting style	Standard mount
Packing system	Taping
Minimum order unit (pcs.)	10,000
Operating temperature range	-30°C to +85°C
Rated current	3A
Contact resistance (Initial)	Connector contacts 40mΩ max.
Stroke Frequency	500 times

Dimensions

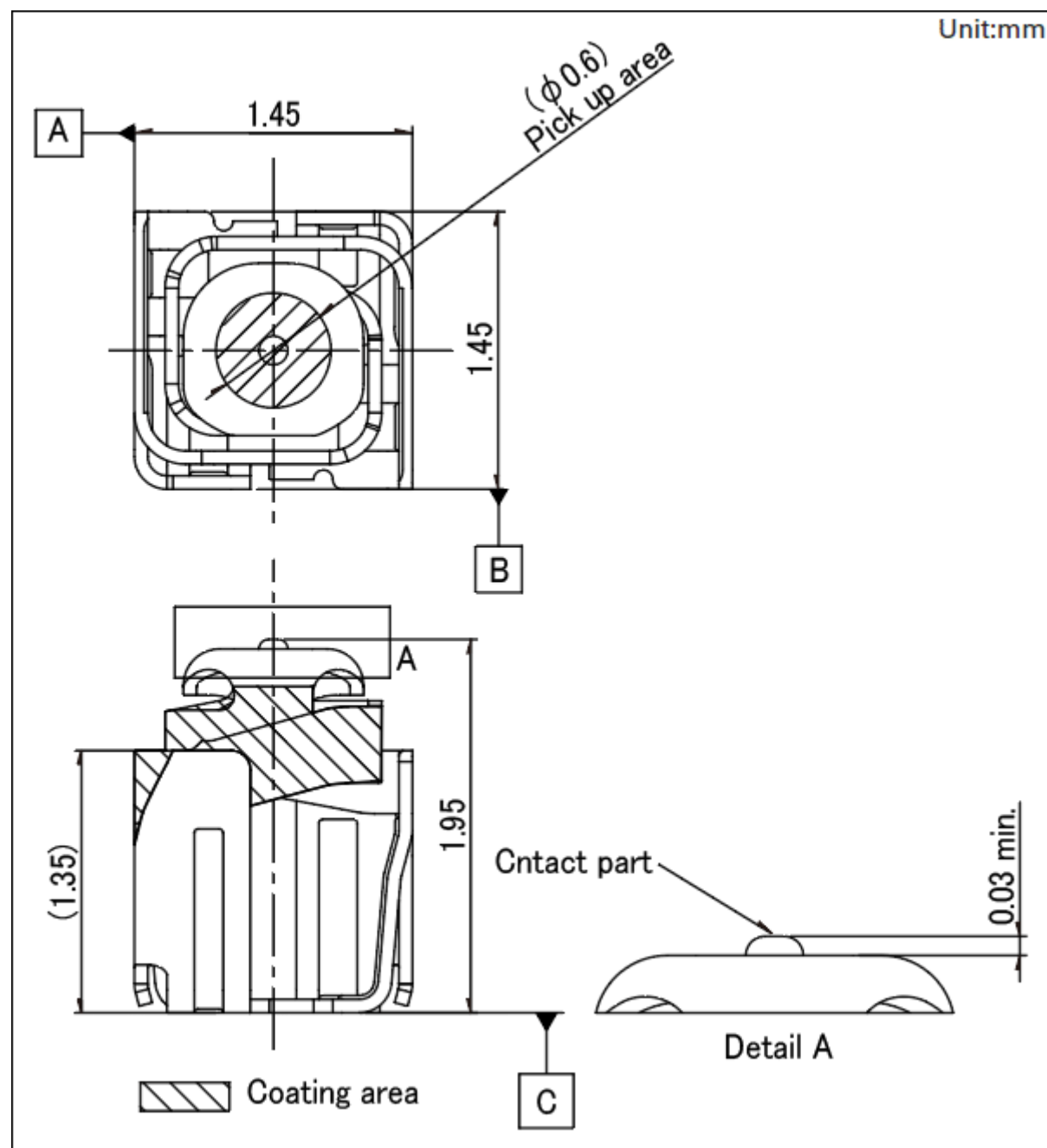

Land Dimensions

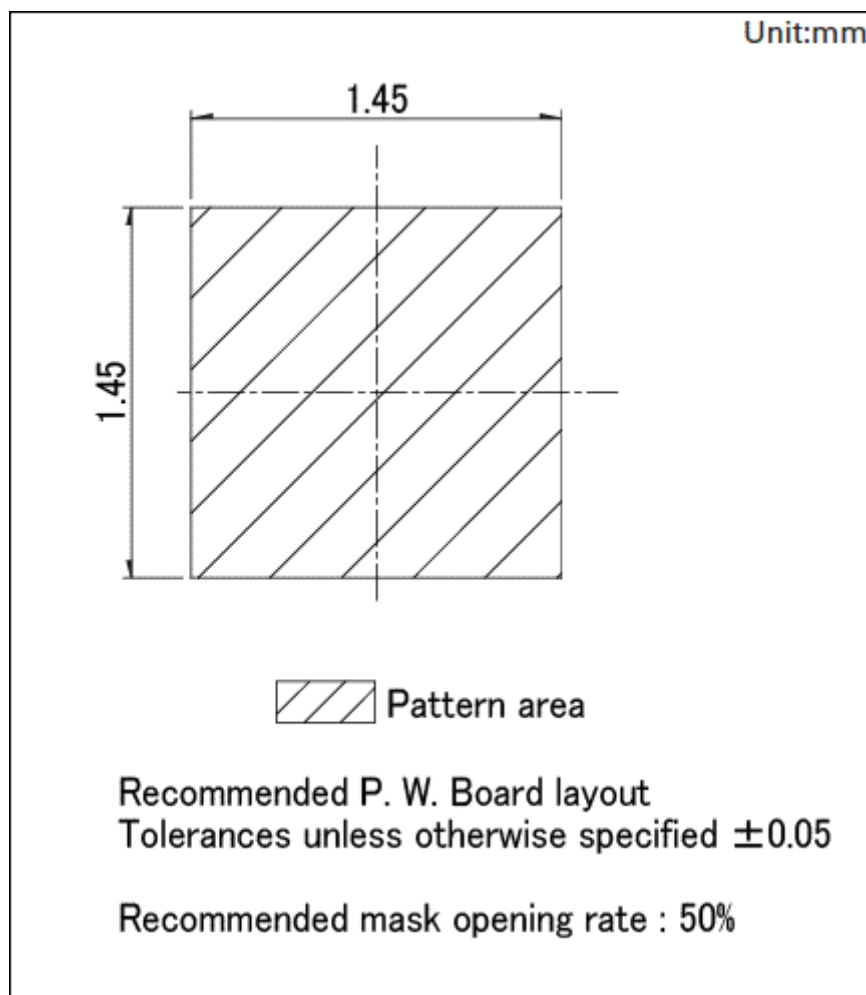

Packing Specifications

Taping

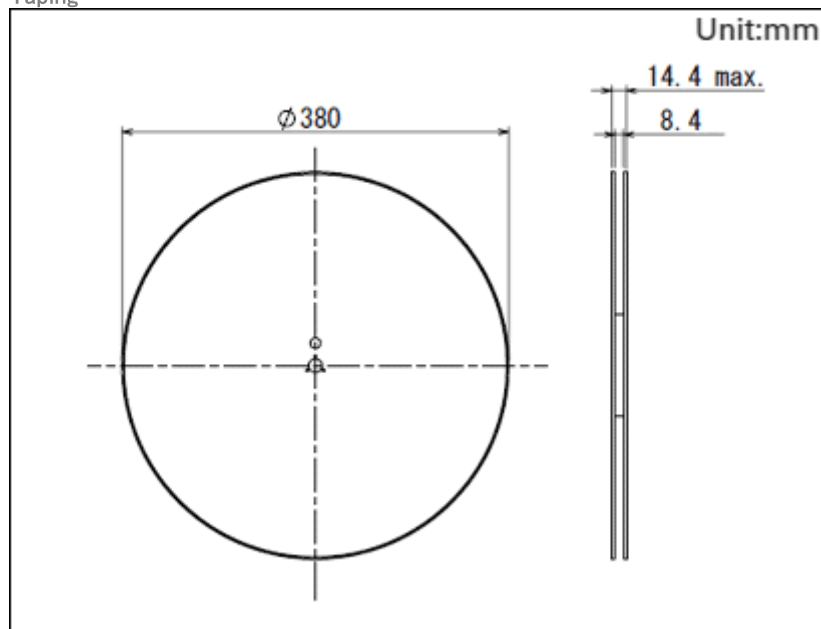

Number of packages (pcs.)	1 reel	10,000
	1 case / Japan	30,000
	1 case / export packing	60,000
Tape width (mm)	8	
Export package measurements (mm)	403 × 403 × 167	

Soldering Conditions

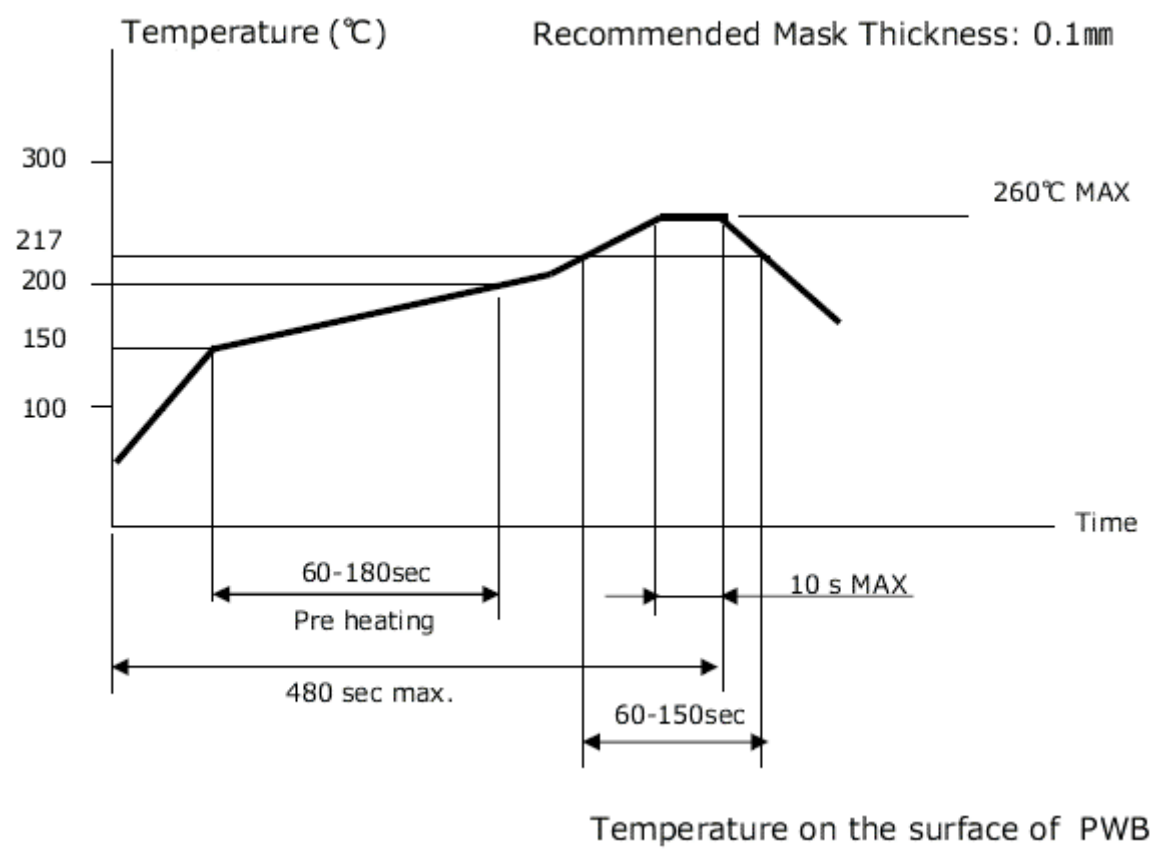

Notes are common to this series/models.

1. This site catalog shows only outline specifications. When using the products, please obtain formal specifications for supply.
2. Please place purchase orders per minimum order unit (integer).

X-ON Electronics

Largest Supplier of Electrical and Electronic Components

Click to view similar products for [Circuit Board Hardware - PCB category](#):

Click to view products by [ALPS manufacturer](#):

Other Similar products are found below :

[8919-0-00-15-00-00-03-0](#) [0135-0-15-01-30-27-04-0](#) [5970-1-15-01-32-14-04-0](#) [0149-0-15-15-30-27-04-0](#) [MBI 1 BLUE](#) [7305-0-15-15-47-14-10-0](#) [MLN 150/1 BLACK](#) [8579-0-15-80-11-27-10-0](#) [8579-1-15-15-11-27-10-0](#) [8830-0-15-01-22-14-10-0](#) [8836-0-00-21-00-00-03-0](#) [PRUEF 2 RED](#) [9976-0-00-00-00-00-03-0](#) [PW1616](#) [1215-3-05-00-00-00-01-0](#) [1231](#) [1303-0-15-15-47-14-04-0](#) [1404-3](#) [1404-4](#) [1406-4](#) [1407-3](#) [1406-3](#) [1407-4](#) [1408-3](#) [1424-4](#) [1427-3](#) [1419-4](#) [1426-4](#) [1548-103](#) [1938-0-00-00-00-00-03-0](#) [1942-0-00-00-00-00-03-0](#) [2101-3-00-44-00-00-07-0](#) [2108-2-00-50-00-00-07-0](#) [2109-2-00-44-00-00-07-0](#) [2110-2-00-44-00-00-07-0](#) [2111-2-00-00-00-00-07-0](#) [2113-4-00-44-00-00-07-0](#) [2301-3-00-44-00-00-07-0](#) [2308-1-00-50-00-00-07-0](#) [2313-2-00-00-00-00-07-0](#) [2315-2-01-44-00-00-07-0](#) [2333-1-00-50-00-00-07-0](#) [9000-0-00-00-00-00-03-0](#) [2506-2-00-50-00-00-07-0](#) [2507-2-01-44-00-00-07-0](#) [2508-2-00-44-00-00-07-0](#) [2561-2-00-44-00-00-07-0](#) [9220](#) [9234-0-15-15-30-14-10-0](#) [LAS S G BLACK](#)