

SKRM

4.5mm Square Low-profile (Surface Mount Type)

Compact, low-profile type with a height of 0.4mm



TACT Switch™

Sharp Feeling

Soft Feeling

Snap-In Type

Surface Mount Type

Radial Type

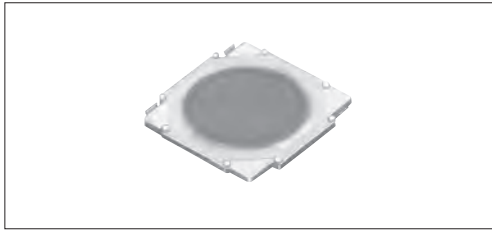

Typical Specifications

Items	Specifications
Rating (max.)	50mA 12V DC
Rating (min.)	10μA 1V DC
Initial contact resistance	100mΩ max.

Product Line

Product No.	Operating force	Operating direction	Travel (mm)	Operating life (5mA 5V DC)	Minimum order unit (pcs.)	
					Japan	Export
SKRMAAE010	1.57N	Top push	0.15	500,000 cycles	10,000	10,000
SKRMABE010	2.55N		0.2	100,000 cycles		

Packing Specifications

Taping

Number of packages (pcs.)			Tape width (mm)	Export package measurements (mm)
1 reel	1 case / Japan	1 case / export packing		
10,000	100,000	100,000	12	395×395×205

Note

For reels of 330mm diameter, please inquire.

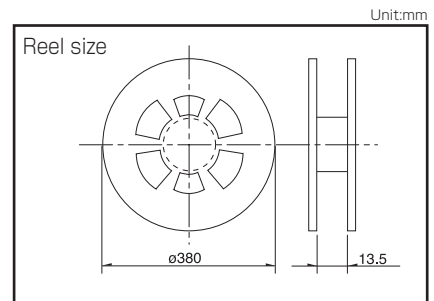

Dimensions

Style	PC board land dimensions (Viewed from switch mounting face)

Circuit Diagram

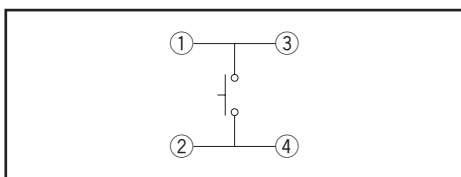

Refer to P.235 for soldering conditions.

TACT Switch™

List of Varieties

TACT Switch™















Sharp Feeling

Soft Feeling

Snap-in Type

Surface Mount Type

Radial Type

Type		Sharp Feeling Type						
		Surface Mount						
Series		SKSH	SKRW	SKRM	SKRB	SKRR	SKQG	SKTC
Photo								
Features		Low-profile				Low-profile and long life	Low-profile	Double action
Water-proof		—	—	—	—	—	—	●
Dustproof		—	—	—	—	—	—	●
IP standard		—	—	—	—	—	—	67 equivalent
Operating direction	Top push	●	●	●	●	●	●	●
	Side push	—	—	—	—	—	—	—
Dimensions (mm)	W	3.3	□3.7	□4.5	□4.8	7.5	□5.2	3.4
	D	2.9				7		2.2
	H	0.35		0.4	0.55	0.6	1.5	0.62
Operation force coverage	1N max.							See the relevant pages for respective product descriptions
	1N to 2N	↕		↕		↕	↕	
	2N to 3N	↕		↕		↕		
	3N to 4N	↕		↕		↕		
4N to 5N	↕		↕		↕	↕		
Travel (mm)		0.15		0.15/0.2		0.25		See the relevant pages for respective product descriptions
Ground terminal		—	—	—	—	—	—	—
Operating temperature range		-30°C to +85°C			-40°C to +85°C		-40°C to +90°C	-30°C to +85°C
Automotive use		—	—	—	●	—	●	—
Life Cycle								
Electrical performance	Rating (max.) (Resistive load)	50mA 12V DC						
	Rating (min.) (Resistive load)	10μA 1V DC						
	Insulation resistance	100MΩ min. 100V DC 1min.						
	Voltage proof	100V AC 1min.				250V AC 1min.	100V AC 1min.	
Durability	Vibration	10 to 55 to 10Hz/min., the amplitude is 1.5mm for all the frequencies, in the 3 direction of X, Y and Z for 2 hours respectively						
	Lifetime	Shall be in accordance with individual specifications.						
Environmental performance	Cold	-40°C 96h						
	Dry heat	90°C 96h						
	Damp heat	60°C, 90 to 95%RH 96h						
Page		188	189	190	191	192	193	194

W : Width. The most outer dimension excluding terminal portion.
 D : Depth. The most outer dimension excluding terminal portion.
 H : Height. The minimum dimension if there are variances.

TACT Switch™ Soldering Conditions 235
 TACT Switch™ Cautions 236

Notes

- The automotive operating temperature range to be individually discussed upon request.
- Indicates applicability to all products in the series.

TACT Switch™ / Soldering Conditions

Condition for Reflow

Available for Surface Mount Type.

Temperature profile

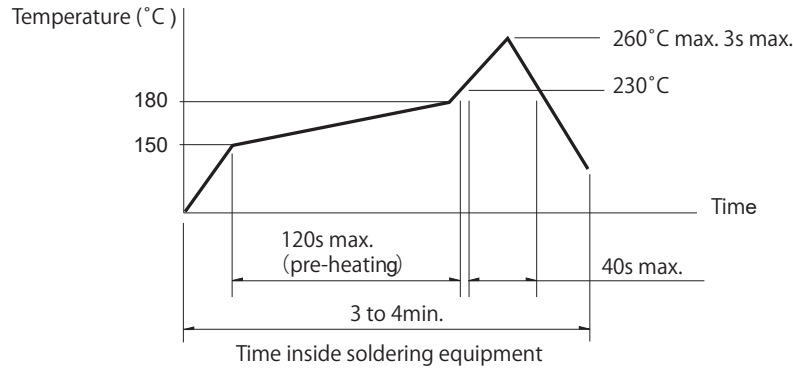

Notes

1. Please confirm the specifications of our product for the detailed condition.
2. Soldering conditions differ depending on reflow soldering machines.
Prior verification of soldering condition is highly recommended.

Conditions for Auto-dip

Available for Snap-in Type and Radial Type.

Items	Condition
Flux built-up	Mounting surface should not be exposed to flux
Preheating temperature	Ambient temperature of the soldered surface of PC board. 100°C max.
Preheating time	60s max.
Soldering temperature	260°C max.
Duration of immersion	5s max.
Number of soldering	2times max.

SKHH Series

Items	Condition
Flux built-up	Mounting surface should not be exposed to flux
Preheating temperature	Ambient temperature of the soldered surface of PC board. 100°C max.
Preheating time	60s max.
Soldering temperature	260°C max.
Duration of immersion	5s max.
Number of soldering	2times max.

SKHL Top Push Type, SKQJ Series

Items	Condition
Flux built-up	Mounting surface should not be exposed to flux
Preheating temperature	Ambient temperature of the soldered surface of PC board. 100°C max.
Preheating time	45s max.
Soldering temperature	255°C max.
Duration of immersion	5s max.
Number of soldering	2times max.

Notes

1. Prevent flux penetration from the top side of the TACT Switch™.
2. Switch terminals and a PC board should not be coated with flux prior to soldering.
3. The second soldering should be done after the switch is stable with normal temperature.
4. Use the flux with a specific gravity of min 0.81.
(EC-19S-8 by TAMURA CORPORATION, or equivalents.)

Manual Soldering

Items	Condition
Soldering temperature	350°C max.
Duration of soldering	3s max.
Capacity of soldering iron	60W max.

SKHH, SKHW Series

Items	Condition
Soldering temperature	360°C max.
Duration of soldering	3s max.
Capacity of soldering iron	60W max.

SKTD, SKTG, SKQJ, SKSN Series

Items	Condition
Soldering temperature	350°C max.
Duration of soldering	3s max.
Capacity of soldering iron	20W max.

TACT Switch™

Sharp Feeling

Soft Feeling

Snap-in Type

Surface Mount Type

Radial Type

X-ON Electronics

Largest Supplier of Electrical and Electronic Components

Click to view similar products for [Tactile Switches](#) category:

Click to view products by [ALPS](#) manufacturer:

Other Similar products are found below :

[5GTH92001](#) [5GTH9202242](#) [1-1977120-4](#) [ADTSA62RV](#) [ADTSA63KV](#) [ADTSA644NV](#) [ADTSMW66NV](#) [ADTSMW67RV](#) [B3F-3123](#) [B3F-6055A](#) [B3F-B32-01-KIT](#) [1977177-8](#) [1977266-1](#) [ADTS644KV](#) [ADTSA61RV](#) [ADTSA62KV](#) [ADTSA63NV](#) [ADTSA63RV](#) [ADTSM21NSVTR](#) [ADTSM32NVTR](#) [ADTSM61YVTR](#) [ADTSM63SVTR](#) [ADTSM644KVTR](#) [ADTSMW64RV](#) [ADTSMW69NV](#) [FSMRA4JHA04](#) [GS4.70F300QP](#) [3ESH9R](#) [506E00201](#) [MJTP1164TR](#) [3FTL600RAS](#) [3FTL640RAS](#) [Y96K132V0FPLFS](#) [101-TS5022T1601-EV](#) [5GSH92001](#) [KSJ0A231](#) [80SH LFG](#) [EVQ-P1D05K](#) [MJTP1162TR](#) [ADTSM63KV](#) [2-1977120-7](#) [TSJW-5.2-260-TR](#) [KMT011MNGJLHS](#) [ADTSA648RV](#) [70-201.0](#) [ADTSM62KSVTR](#) [ATA600VTR](#) [ADTSG66RV](#) [ADTS61NV](#) [ADTSM62KVTR](#) [ADTSM25KSVB](#)