

SKSN

6.2×3mm Side Push Mid-mount Type (Surface Mount Type)

Mid-mount type with height of 1.35mm above the PC board when installed

(※1)  
 (※1) Except SKSNLAE010

TACT Switch™

Sharp Feeling

Soft Feeling

Snap-in Type

Surface Mount Type

Radial Type

■ Typical Specifications



| Items | Specifications |
|----------------------------|---------------------------------------|
| Rating (max.) | 50mA 16V DC (SKSNLAE: 50mA 12V DC) |
| Rating (min.) | 10μA 1V DC |
| Initial contact resistance | 100mΩ Max |
| Travel (mm) | 0.2 |

■ Product Line

| Product No. | Operating force | Operating direction | Operating life (5mA 5V DC) | Minimum order unit (pcs.) | |
|-------------------|-----------------|---------------------|-------------------------------|---------------------------|--------|
| | | | | Japan | Export |
| SKSNLAE010 | 2.4N | Side push | 500,000 cycles | 2,500 | 2,500 |
| SKSNLKE010 | 4.5N | | 100,000 cycles | | |
| SKSNLHE010 | 5N | | | | |

■ Packing Specifications

Taping

| Number of packages (pcs.) | | | Tape width (mm) | Export package measurements (mm) |
|---------------------------|----------------|-------------------------|--------------------|-------------------------------------|
| 1 reel | 1 case / Japan | 1 case / export packing | | |
| 2,500 | 25,000 | 25,000 | 12 | 395×395×205 |

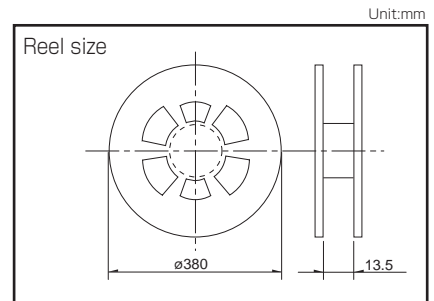

Note

For reels of 330mm diameter, please inquire.







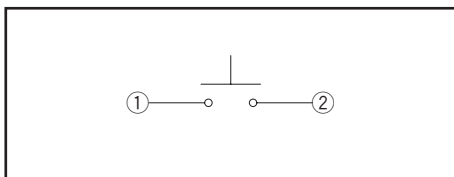









■ Dimensions

| Style | PC board mounting hole and land dimensions (Viewed from switch mounting face) |
|-------|--|
| | |

■ Circuit Diagram



Refer to P.235 for soldering conditions.

| Type | | Sharp Feeling Type | | | | | | | |
|-----------------------------|--------------------------------|--|---|---|---|---|---|---|---|
| | | Surface Mount | | | | | | | |
| Series | | SKST | SKRA | SKHM | SKHU | SKTD | SKSN | SKTG | SKSL |
| Photo | |  |  |  |  |  |  |  |  |
| Features | | Middle travel | | — | — | Low-profile | Mid-mount | Half-mount | |
| Water-proof | | — | ○ | — | ○ | ● | — | ● | — |
| Dustproof | | — | ○ | — | ○ | ● | — | ● | — |
| IP standard | | — | 67 equivalent | — | — | 67 equivalent | — | 67 equivalent | — |
| Operating direction | Top push | ● | ● | ● | ● | — | — | — | — |
| | Side push | — | — | — | — | ● | ● | ● | ● |
| Dimensions (mm) | W | □8.5 | □6.2 | 6.2 | 6.2 | 3.9 | 6.2 | 5.2 | 4.5 |
| | D | — | — | 6.5 | 6.3 | 2.9 | 3 | 3.5 | 2.6 |
| | H | 3.95 | 3.5/5.2 | 3.1 | 2.5/3.1 | 1.55 | 3.5 | 1.55 | 2.2 |
| Operation force coverage | 1N max. | 4N to 10N | ↕ | ↕ | ↕ | ↕ | ↕ | ↕ | ↕ |
| | 1N to 2N | | | | | | | | |
| | 2N to 3N | | | | | | | | |
| | 3N to 4N | | | | | | | | |
| 4N to 5N | | | | | | | | | |
| Travel (mm) | | 0.9 | See the relevant pages for respective product description | 0.25 | | 0.15 | 0.2 | 0.15 | |
| Ground terminal | | — | — | ● | ● | ● | ● | ● | ● |
| Operating temperature range | | -40°C to +90°C | | -40°C to +85°C | | -30°C to +85°C | -40°C to +85°C | -30°C to +85°C | |
| Automotive use | | ● | ○ | — | ● | — | ○ | — | ○ |
| Life Cycle | |  |  |  |  |  |  |  |  |
| Electrical performance | Rating (max.) (Resistive load) | 50mA 16V DC | 50mA 12V DC | | | | | | |
| | Rating (min.) (Resistive load) | 10μA 1V DC | | | | | | | |
| | Insulation resistance | 100MΩ min. 100V DC 1min. | | | | | | | |
| | Voltage proof | 250V AC 1min. | | | 100V AC 1min. | | 250V AC 1min. | | 100V AC 1min. |
| Durability | Vibration | 10 to 55 to 10Hz/min., the amplitude is 1.5mm for all the frequencies, in the 3 direction of X, Y and Z for 2 hours respectively | | | | | | | |
| | Lifetime | Shall be in accordance with individual specifications. | | | | | | | |
| Environmental performance | Cold | -40°C 1,000h | | -40°C 96h | | | | | |
| | Dry heat | 90°C 1,000h | | 90°C 96h | 85°C 96h | 90°C 96h | 85°C 96h | 90°C 96h | |
| | Damp heat | 60°C, 90 to 95%RH 1,000h | | 60°C, 90 to 95%RH 96h | | | | | |
| Page | | 216 | 217 | 218 | 219 | 221 | 222 | 223 | 224 |

W : Width. The most outer dimension excluding terminal portion.
D : Depth. The most outer dimension excluding terminal portion.
H : Height. The minimum dimension if there are variances.

TACT Switch™ Soldering Conditions 235
TACT Switch™ Cautions 236

Notes

1. The automotive operating temperature range to be individually discussed upon request.
2. ● Indicates applicability to all products in the series, while ○ indicates applicability to some products in the series.

TACT Switch™

Sharp Feeling

Soft Feeling

Snap-In Type

Surface Mount Type

Radial Type

TACT Switch™ / Soldering Conditions

Condition for Reflow

Available for Surface Mount Type.

Temperature profile

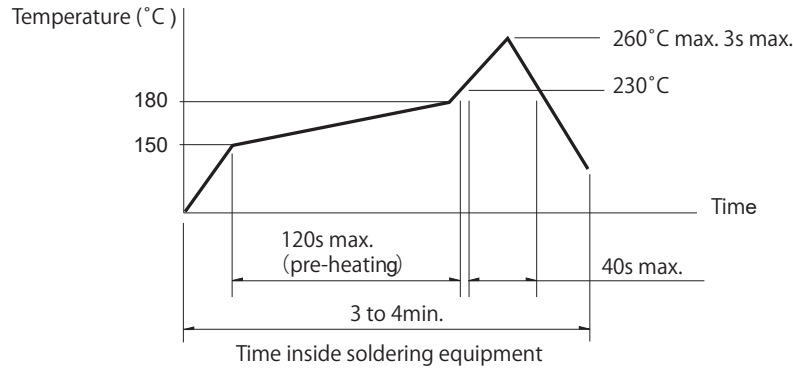

Notes

1. Please confirm the specifications of our product for the detailed condition.
2. Soldering conditions differ depending on reflow soldering machines.
Prior verification of soldering condition is highly recommended.

Conditions for Auto-dip

Available for Snap-in Type and Radial Type.

| Items | Condition |
|------------------------|---|
| Flux built-up | Mounting surface should not be exposed to flux |
| Preheating temperature | Ambient temperature of the soldered surface of PC board. 100°C max. |
| Preheating time | 60s max. |
| Soldering temperature | 260°C max. |
| Duration of immersion | 5s max. |
| Number of soldering | 2times max. |

SKHH Series

| Items | Condition |
|------------------------|---|
| Flux built-up | Mounting surface should not be exposed to flux |
| Preheating temperature | Ambient temperature of the soldered surface of PC board. 100°C max. |
| Preheating time | 60s max. |
| Soldering temperature | 260°C max. |
| Duration of immersion | 5s max. |
| Number of soldering | 2times max. |

SKHL Top Push Type, SKQJ Series

| Items | Condition |
|------------------------|---|
| Flux built-up | Mounting surface should not be exposed to flux |
| Preheating temperature | Ambient temperature of the soldered surface of PC board. 100°C max. |
| Preheating time | 45s max. |
| Soldering temperature | 255°C max. |
| Duration of immersion | 5s max. |
| Number of soldering | 2times max. |

Notes

1. Prevent flux penetration from the top side of the TACT Switch™.
2. Switch terminals and a PC board should not be coated with flux prior to soldering.
3. The second soldering should be done after the switch is stable with normal temperature.
4. Use the flux with a specific gravity of min 0.81.
(EC-19S-8 by TAMURA CORPORATION, or equivalents.)

Manual Soldering

| Items | Condition |
|----------------------------|------------|
| Soldering temperature | 350°C max. |
| Duration of soldering | 3s max. |
| Capacity of soldering iron | 60W max. |

SKHH, SKHW Series

| Items | Condition |
|----------------------------|------------|
| Soldering temperature | 360°C max. |
| Duration of soldering | 3s max. |
| Capacity of soldering iron | 60W max. |

SKTD, SKTG, SKQJ, SKSN Series

| Items | Condition |
|----------------------------|------------|
| Soldering temperature | 350°C max. |
| Duration of soldering | 3s max. |
| Capacity of soldering iron | 20W max. |

TACT Switch™

Sharp Feeling

Soft Feeling

Snap-in Type

Surface Mount Type

Radial Type

X-ON Electronics

Largest Supplier of Electrical and Electronic Components

Click to view similar products for [Tactile Switches](#) category:

Click to view products by [ALPS](#) manufacturer:

Other Similar products are found below :

[5GTH92001](#) [5GTH9202242](#) [1-1977120-4](#) [ADTSA62RV](#) [ADTSA63KV](#) [ADTSA644NV](#) [ADTSMW66NV](#) [ADTSMW67RV](#) [B3F-3123](#) [B3F-6055A](#) [B3F-B32-01-KIT](#) [1977177-8](#) [1977266-1](#) [ADTS644KV](#) [ADTSA61RV](#) [ADTSA62KV](#) [ADTSA63NV](#) [ADTSA63RV](#) [ADTSM21NSVTR](#) [ADTSM32NVTR](#) [ADTSM61YVTR](#) [ADTSM63SVTR](#) [ADTSM644KVTR](#) [ADTSMW64RV](#) [ADTSMW69NV](#) [FSMRA4JHA04](#) [GS4.70F300QP](#) [3ESH9R](#) [506E00201](#) [MJTP1164TR](#) [3FTL600RAS](#) [3FTL640RAS](#) [Y96K132V0FPLFS](#) [101-TS5022T1601-EV](#) [5GSH92001](#) [KSJ0A231](#) [80SH LFG](#) [EVQ-P1D05K](#) [MJTP1162TR](#) [ADTSM63KV](#) [2-1977120-7](#) [TSJW-5.2-260-TR](#) [KMT011MNGJLHS](#) [ADTSA648RV](#) [70-201.0](#) [ADTSM62KSVTR](#) [ATA600VTR](#) [ADTSG66RV](#) [ADTS61NV](#) [ADTSM62KVTR](#) [ADTSM25KSVB](#)