

SKTG

3.7×3.5mm Side Push Half-mount Type (Surface Mount Type)

Half-mount type with 0.85mm installed height above the PC board



Typical Specifications

Items	Specifications
Rating (max.)	50mA 12V DC
Rating (min.)	10μA 1V DC
Initial contact resistance	500mΩ max.
Travel (mm)	0.15
Protective structure ※	IP67 equivalent

Product Line

Product No.	Operating force	Operating direction	Operating life (5mA 5V DC)	Minimum order unit (pcs.)	
				Japan	Export
SKTGLBE010	1.6N	Side push	200,000 cycles	5,500	5,500

Packing Specifications

Taping

Number of packages (pcs.)			Tape width (mm)	Export package measurements (mm)
1 reel	1 case / Japan	1 case / export packing		
5,500	55,000	55,000	12	395×395×205

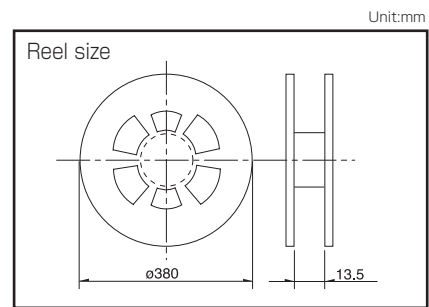

Note

For reels of 330mm diameter, please inquire.

Dimensions

Style	PC board mounting hole and land dimensions (Viewed from switch mounting face)

Circuit Diagram

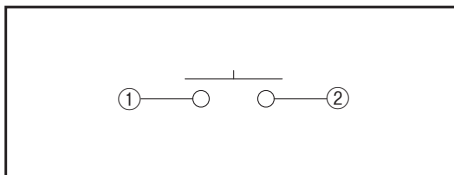

※ Assumes the switch is left alone without being operated. Under the specified conditions, dust and water ingress with a significant impact on the switch's on-off function is prevented.
IP67-level dust and water resistance is guaranteed for the switch alone and performance may not be guaranteed depending on the mounting conditions and usage.

Refer to P.235 for soldering conditions.

TACT Switch™

















Sharp Feeling

Soft Feeling

Snap-In Type

Surface Mount Type

Radial Type

Type		Sharp Feeling Type							
		Surface Mount							
Series		SKST	SKRA	SKHM	SKHU	SKTD	SKSN	SKTG	SKSL
Photo									
Features		Middle travel		—	—	Low-profile	Mid-mount	Half-mount	
Water-proof		—	○	—	○	●	—	●	—
Dustproof		—	○	—	○	●	—	●	—
IP standard		—	67 equivalent	—	—	67 equivalent	—	67 equivalent	—
Operating direction	Top push	●	●	●	●	—	—	—	—
	Side push	—	—	—	—	●	●	●	●
Dimensions (mm)	W	□8.5	□6.2	6.2	6.2	3.9	6.2	5.2	4.5
	D			6.5	6.3	2.9	3	3.5	2.6
	H	3.95	3.5/5.2	3.1	2.5/3.1	1.55	3.5	1.55	2.2
Operation force coverage	1N max.	4N to 10N	↕	↕	↕	↕	↕	↕	↕
	1N to 2N								
	2N to 3N								
	3N to 4N								
Travel (mm)		0.9	See the relevant pages for respective product description	0.25		0.15	0.2	0.15	
Ground terminal		—	—	●	●	●	●	●	●
Operating temperature range		-40°C to +90°C		-40°C to +85°C		-30°C to +85°C	-40°C to +85°C	-30°C to +85°C	
Automotive use		●	○	—	●	—	○	—	○
Life Cycle									
Electrical performance	Rating (max.) (Resistive load)	50mA 16V DC	50mA 12V DC						
	Rating (min.) (Resistive load)	10μA 1V DC							
	Insulation resistance	100MΩ min. 100V DC 1min.							
	Voltage proof	250V AC 1min.			100V AC 1min.		250V AC 1min.		100V AC 1min.
Durability	Vibration	10 to 55 to 10Hz/min., the amplitude is 1.5mm for all the frequencies, in the 3 direction of X, Y and Z for 2 hours respectively							
	Lifetime	Shall be in accordance with individual specifications.							
Environmental performance	Cold	-40°C 1,000h		-40°C 96h					
	Dry heat	90°C 1,000h		90°C 96h	85°C 96h	90°C 96h	85°C 96h	90°C 96h	
	Damp heat	60°C, 90 to 95%RH 1,000h		60°C, 90 to 95%RH 96h					
Page		216	217	218	219	221	222	223	224

W : Width. The most outer dimension excluding terminal portion.
D : Depth. The most outer dimension excluding terminal portion.
H : Height. The minimum dimension if there are variances.

TACT Switch™ Soldering Conditions 235
TACT Switch™ Cautions 236

Notes

1. The automotive operating temperature range to be individually discussed upon request.
2. ● Indicates applicability to all products in the series, while ○ indicates applicability to some products in the series.

TACT Switch™

Sharp Feeling

Soft Feeling

Snap-In Type

Surface Mount Type

Radial Type

TACT Switch™ / Soldering Conditions

TACT Switch™

Sharp Feeling

Soft Feeling

Snap-in Type

Surface Mount Type

Radial Type

Condition for Reflow

Available for Surface Mount Type.

Temperature profile

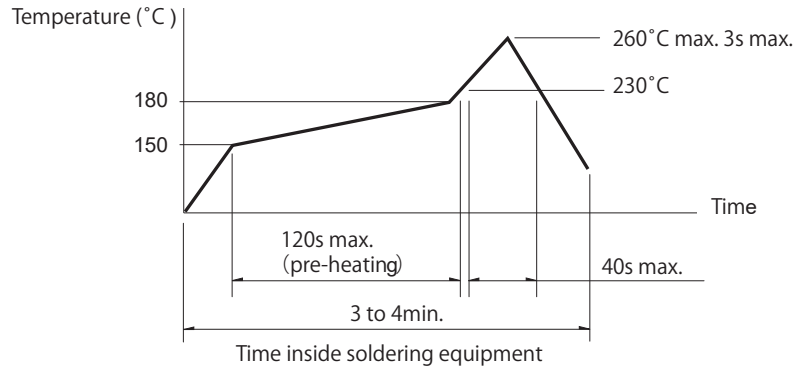

Notes

1. Please confirm the specifications of our product for the detailed condition.
2. Soldering conditions differ depending on reflow soldering machines.
Prior verification of soldering condition is highly recommended.

Conditions for Auto-dip

Available for Snap-in Type and Radial Type.

Items	Condition
Flux built-up	Mounting surface should not be exposed to flux
Preheating temperature	Ambient temperature of the soldered surface of PC board. 100°C max.
Preheating time	60s max.
Soldering temperature	260°C max.
Duration of immersion	5s max.
Number of soldering	2times max.

SKHH Series

Items	Condition
Flux built-up	Mounting surface should not be exposed to flux
Preheating temperature	Ambient temperature of the soldered surface of PC board. 100°C max.
Preheating time	60s max.
Soldering temperature	260°C max.
Duration of immersion	5s max.
Number of soldering	2times max.

SKHL Top Push Type, SKQJ Series

Items	Condition
Flux built-up	Mounting surface should not be exposed to flux
Preheating temperature	Ambient temperature of the soldered surface of PC board. 100°C max.
Preheating time	45s max.
Soldering temperature	255°C max.
Duration of immersion	5s max.
Number of soldering	2times max.

Notes

1. Prevent flux penetration from the top side of the TACT Switch™.
2. Switch terminals and a PC board should not be coated with flux prior to soldering.
3. The second soldering should be done after the switch is stable with normal temperature.
4. Use the flux with a specific gravity of min 0.81.
(EC-19S-8 by TAMURA CORPORATION, or equivalents.)

Manual Soldering

Items	Condition
Soldering temperature	350°C max.
Duration of soldering	3s max.
Capacity of soldering iron	60W max.

SKHH, SKHW Series

Items	Condition
Soldering temperature	360°C max.
Duration of soldering	3s max.
Capacity of soldering iron	60W max.

SKTD, SKTG, SKQJ, SKSN Series

Items	Condition
Soldering temperature	350°C max.
Duration of soldering	3s max.
Capacity of soldering iron	20W max.

X-ON Electronics

Largest Supplier of Electrical and Electronic Components

Click to view similar products for [Tactile Switches](#) category:

Click to view products by [ALPS](#) manufacturer:

Other Similar products are found below :

[5GTH92001](#) [5GTH9202242](#) [1-1977120-4](#) [ADTSA62RV](#) [ADTSA63KV](#) [ADTSA644NV](#) [ADTSMW66NV](#) [ADTSMW67RV](#) [B3F-3123](#) [B3F-6055A](#) [B3F-B32-01-KIT](#) [1977177-8](#) [1977266-1](#) [ADTS644KV](#) [ADTSA61RV](#) [ADTSA62KV](#) [ADTSA63NV](#) [ADTSA63RV](#) [ADTSM21NSVTR](#) [ADTSM32NVTR](#) [ADTSM61YVTR](#) [ADTSM63SVTR](#) [ADTSM644KVTR](#) [ADTSMW64RV](#) [ADTSMW69NV](#) [FSMRA4JHA04](#) [GS4.70F300QP](#) [3ESH9R](#) [506E00201](#) [MJTP1164TR](#) [3FTL600RAS](#) [3FTL640RAS](#) [Y96K132V0FPLFS](#) [101-TS5022T1601-EV](#) [5GSH92001](#) [KSJ0A231](#) [80SH LFG](#) [EVQ-P1D05K](#) [MJTP1162TR](#) [ADTSM63KV](#) [2-1977120-7](#) [TSJW-5.2-260-TR](#) [KMT011MNGJLHS](#) [ADTSA648RV](#) [70-201.0](#) [ADTSM62KSVTR](#) [ATA600VTR](#) [ADTSG66RV](#) [ADTS61NV](#) [ADTSM62KVTR](#) [ADTSM25KSVB](#)