

SRBM

6-position Horizontal Type

Pulse switching (20 pulses) model available in same shape

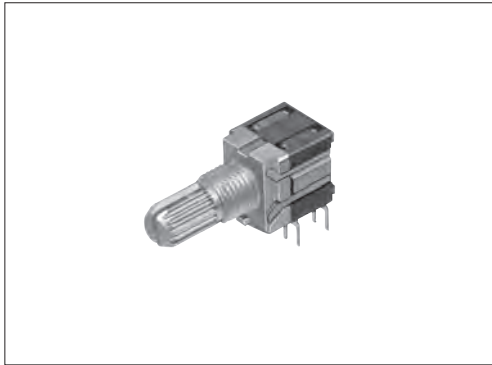

Typical Specifications

Items		Specifications	
		Rotary switch	Pulse switch
Rating (max.)/(min.) (Resistive load)		0.1A 16V DC / 50μA 3V DC	
Contact resistance (Initial / After operating life)		50mΩ max. / 150mΩ max.	
Rotational torque		40±20 mN·m	15±7 mN·m
Operating life	Without load	10,000 cycles	30,000 cycles
	With load	10,000 cycles (0.1A 16V DC)	

Product Line

Number of wafers	Poles	Positions	Changeover angle	Changeover timing	Actuator configuration	Actuator length (mm)	Minimum order unit (pcs.)		Product No.	Drawing No.
							Japan	Export		
1	2	2	30±3°	Non shorting	18-tooth serration	L=15	360	1,800	SRBM120700	1
					Flat				SRBM121300	
		3			18-tooth serration	L=20	210	1,050	SRBM131300	
					Flat	L=15	360	1,800	SRBM131400	
		4			18-tooth serration	L=20	210	1,050	SRBM140700	
					Flat	L=20	210	1,050	SRBM140800	
	1	5	18-tooth serration	L=15	360	1,800	SRBM150500			
			Flat				SRBM154002			
		6	18-tooth serration				SRBM160700			
			Flat				SRBM1L0800			
20 pulses	18±3°	—	18-tooth serration	L=15	360	1,800	SRBM1L0800	2		
			Flat				SRBM1L1400			

Note

All the axis are die casting shafts.

Packing Specifications

Tray

Product No.	Number of packages (pcs.)		Export package measurements (mm)
	1 case / Japan	1 case / export packing	
SRBM120700 SRBM121300 SRBM131300 SRBM140700 SRBM150500 SRBM154002 SRBM160700 SRBM1L0800 SRBM1L1400	360	1,800	400×270×290
SRBM131400 SRBM140800 SRBM149501	210	1,050	

Refer to P.139 for shaft configurations.
Refer to P.145 for soldering conditions.

SRBM 6-position Horizontal Type

Detector

Slide

Push

Rotary

Power

Dual-in-line
Package Type

Dimensions

Single-shaft Type

Unit:mm

No.	Style	PC board mounting hole dimensions (Viewed from direction A)
1	Rotary switch 	
2	Pulse switch 	

Pulse Switch Circuit Diagram

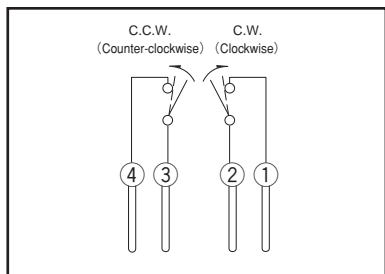

C.W. : ①② ON during changeover only
 C.C.W. : ③④ ON during changeover only

Rotary Switch Circuit Diagram

(Viewed from Direction A of Below Diagram)

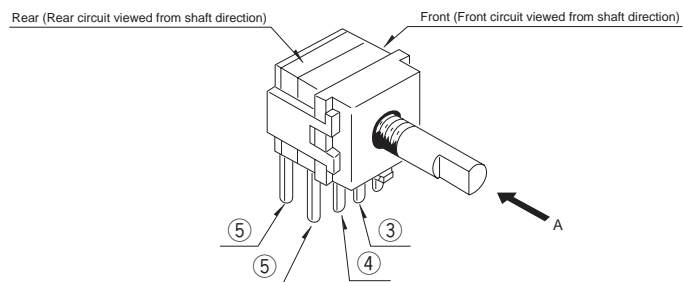

2 to 4-position		5-position * 1		6-position * 2	
Rear	Front	Rear	Front	Rear	Front

Notes

- For position 2 to 4, 1 section consists of 2-pole.
- For position 5 and 6, 1 section consists of 1-pole.
 - * 1: Circuit steps are position 2 to 5 at front and position 1 to 4 at rear. (External wiring to common terminal is required.)
 - * 2: Circuit steps are position 3 to 6 at front and position 1 to 4 at rear. (External wiring to common terminal is required.)

Dummy Terminals

Number of positions	2	3	4	5	6
Front	④ ⑤	⑤	—	—	—
Rear	③ ④	④	—	—	—

18-tooth Serration Shaft

The shaft shows the position in which it is turned fully counterclockwise.

Die Casting Shaft

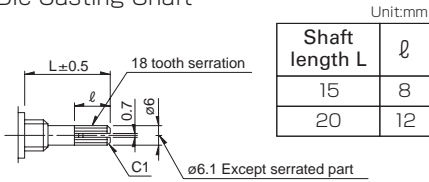

Unit:mm	
Shaft length L	l
15	8
20	12

Details About Serration

- (1) The mold dimensions of standard serration and the dimensions of test jigs are as shown in the figure at left.
- (2) Position of the serration bottom
When the shaft is turned fully counterclockwise, the position of the serration bottom is on the AA line.
- (3) Slitting angle
The slitting angle (position) is not specified.

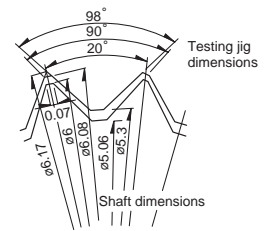

Flat Shaft

The shaft shows the position in which it is turned fully counterclockwise.

Die Casting Shaft

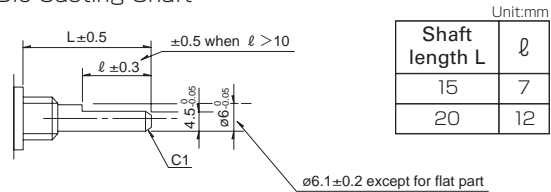

Unit:mm	
Shaft length L	l
15	7
20	12

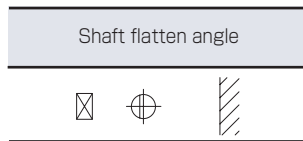

Note

Please be aware that shaft flatten angle is based on (PCB terminal direction)



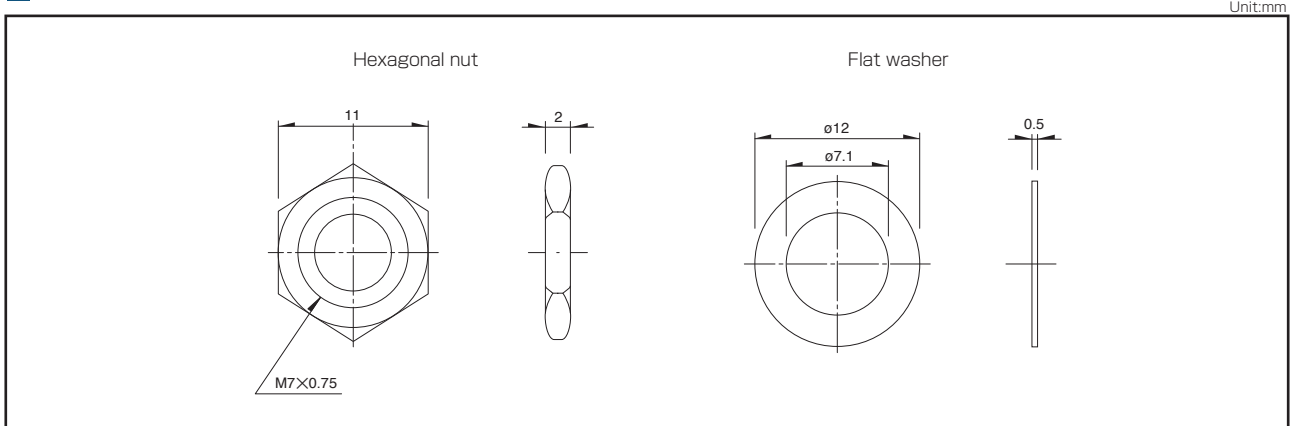







Attached Parts



Rotary Switches

List of Varieties

Detector
Slide
Push
Rotary
Power
Push-line Package Type

Series	SRBD	SRBQ		SRBM		SRBV	SRRM	
		Insertion	Reflow type	Rotary	Pulse			
Photo								
Angle of throw	36°	40±3°		30±3°	18±3°	30±3°		
Number of poles	1		1, 2		1	1, 2, 3, 4		
Rotational torque	13±5mN·m	6±3mN·m 13±5mN·m		40±20mN·m 15±7mN·m		30±15mN·m	80±30mN·m (Shorting) 70±30mN·m (Non shorting)	
Dimensions (mm)	W	10		11.4	10	16.2	—	
	D			12.4	12.5	18.5		
	H	1.7		3.5	11	7.5		
Operating temperature range	-25°C to +85°C	-10°C to +60°C		-30°C to +85°C		-10°C to +85°C	-10°C to +60°C	
Automotive use	—	—		—		—	—	
Life cycle								
Rating (max.)/(min.) (Resistive load)	1mA 5V DC 50µA 3V DC	0.1A 16V DC 50µA 3V DC				0.3A 16V DC 50µA 3V DC	0.25A 30V DC 50µA 3V DC	
Durability	Operating life without load	10,000 cycles 250mΩ max.	10,000 cycles 100mΩ max.		30,000 cycles 100mΩ max.	10,000 cycles 100mΩ max.	10,000 cycles 40mΩ max.	
	Operating life with load Load: as rating	10,000 cycles 250mΩ max.	10,000 cycles 100mΩ max.	10,000 cycles 150mΩ max.		10,000 cycles 150mΩ max.	10,000 cycles 60mΩ max.	
Electrical performance	Initial contact resistance	200mΩ max.	50mΩ max.				20mΩ max.	
	Insulation resistance	100MΩ min. 100V DC					100MΩ min. 500V DC	
	Voltage proof	100V AC for 1minute					500V AC for 1minute	
Mechanical performance	Terminal strength	3N for 1minute	5N for 1minute				10N for 1minute	
	Actuator strength	Operating direction	—	—	0.5N·m	—	0.6N·m	1N·m
		Pulling direction	50N	20N	100N			
	Wobble of actuator	Load at the tip of shaft SRRM, SRBM, SRBQ, SRBV: 1N The below table shows for SRRM, SRBM The below table shows for SRBQ The below table shows for SRBV						
Measuring position from mounting surface		Shaft wobble (max. value)	Applicable mounting dimension	Distance from mounting surface to the tip of shaft	Shaft wobble (max. value)	Measuring position from mounting surface	Shaft wobble (max. value)	Applicable mounting dimension
10		0.17	15	below 5	0.5	10	0.2	15
15		0.25	20	above 5 and below 10	0.9	15	0.3	20
20		0.35	25	above 10 and below 15	1.2	20	0.4	25
25	0.42	30						
30	0.5	above 35						
Unit:mm								
Environmental performance	Cold	-40°C 500h	-20°C 96h	-40°C 96h	-20°C 96h			
	Dry heat	85°C 500h	85°C 96h					
	Damp heat	60°C, 90 to 95%RH 500h	40°C, 90 to 95%RH 96h					
Page	133	135	137	140	142			

Rotary Switches Soldering Conditions	145
Rotary Switches Cautions	146

Rotary Switches / Soldering Conditions

Example of Reflow Soldering Condition

1. Heating method: Double heating method with infrared heater.
2. Temperature measurement: Thermocouple $\phi 0.1$ to 0.2 CA (K) or CC (T) at soldering portion(copper foil surface).
A heat resisting tape should be used for fixed measurement.
3. Temperature profile

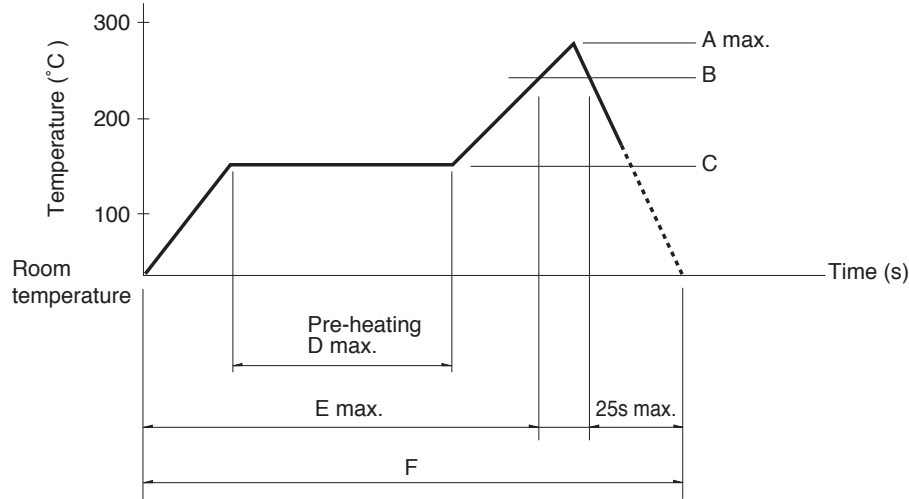

Series (Reflow type)	A (°C) 3s max.	B (°C)	C (°C)	D (s)	E (s)	F (s)
SRBQ	250	200	150±5	80 to 100	—	—

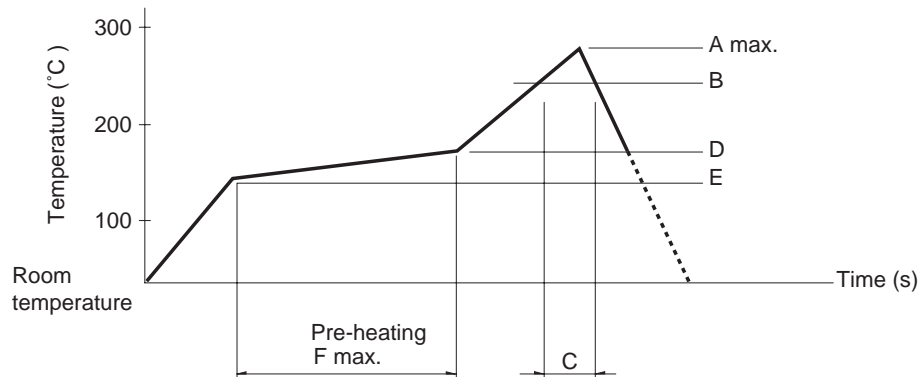

Series (Reflow type)	A (°C) 3s max.	B (°C)	C (s)	D (°C)	E (°C)	F (s)
SRBD	260	230	40	180	150	120

- Notes**
1. The condition mentioned above is the temperature on the mounting surface of a PC board. There are cases where the PC board's temperature greatly differs from that of the switch, depending on the PC board's material, size, thickness, etc. The above-stated conditions shall also apply to switch surface temperatures.
 2. Soldering conditions differ depending on reflow soldering machines. Prior verification of soldering condition is highly recommended.

Reference for Hand Soldering

Series	Soldering temperature	Soldering time
SRBQ, SRBM, SRBV, SRRM	350±10°C	3+1/0s
SRBQ (Reflow type)	350±5°C	3s max.

Reference for Dip Soldering

(For PC board terminal types)

Series	Items		Dip soldering	
	Preheating temperature	Preheating time	Soldering temperature	Duration of immersion
SRBM	100°C max.	60s max.	260±5°C	5s max.
SRBV, SRRM	—	—	260±5°C	10±1s
SRBQ	—	—	260±5°C	5±1s

X-ON Electronics

Largest Supplier of Electrical and Electronic Components

Click to view similar products for [Rotary Switches](#) category:

Click to view products by [ALPS](#) manufacturer:

Other Similar products are found below :

[57HS22-02-2-06N](#) [57M22-02B16N](#) [57M22-09A16N](#) [M3786/4-0881](#) [M3786/4-3267](#) [M3786/4-5568](#) [M3786/4-6029](#) [71ESF30-05204N](#)
[MC06L1NCGF](#) [84986-26](#) [9003K2C003GA](#) [PLR3251](#) [PLR3262](#) [PS3](#) [A0142M2SP](#) [A029303](#) [R2AA4455NNNN](#) [R2BB4455NNNN](#) [DR75-](#)
[AMSF-10R-B](#) [1703.3201](#) [HW1MS-0202-101](#) [24002-03S](#) [A029101](#) [ACSNO-129-YB-C1014](#) [ACSNO-134-RR-YB-C1005](#) [ACSNO-353-SB-](#)
[C3016](#) [1825537-4](#) [T505](#) [T505E](#) [24005-03N](#) [H10207RR01Q](#) [M3786/39-4ZC](#) [M3786/4-0002](#) [M3786/4-0630](#) [M3786/4-1028L](#) [M3786/4-](#)
[1233L](#) [M3786/4-3044](#) [M3786/4-3129](#) [M3786/4-5008L](#) [M3786/4-5256](#) [MC6CX1A502X009](#) [42HS36-01-1-06N](#) [42P36-03B10S](#) [44MBS60-](#)
[04-2-03N](#) [44MG90-02-1-02N](#) [50KMT90-01-2-02N](#) [51A22-01-1-16S](#) [51CDP30-01PAJN](#) [51KSP30-01D04N](#) [51P30-01B12N](#)