

Technical Data

Plastic bodied limit switch

Series C2

Description **C2-U1Z FLACHST.**

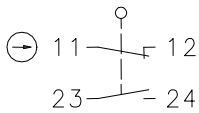

Article number **6108101039**

Operating symbol

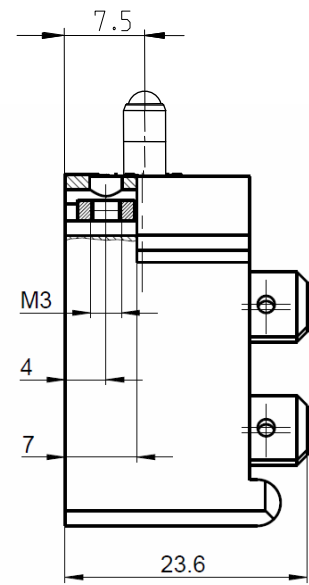
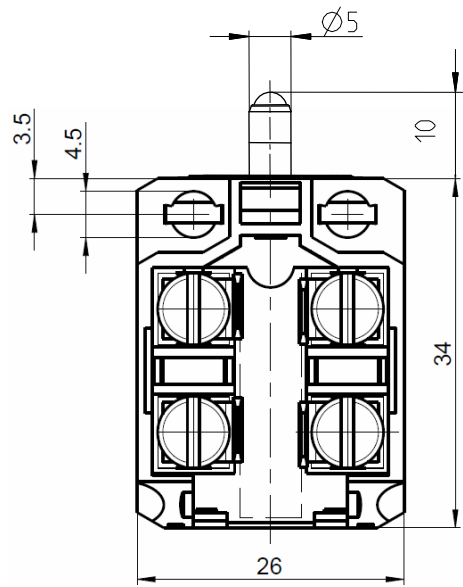
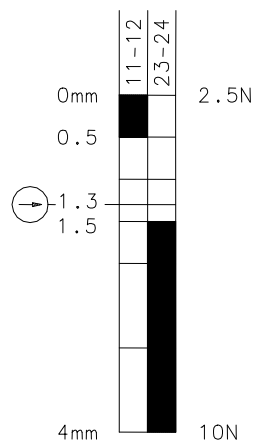

Operating diagram



  Tolerance:
 Operating point $\pm 0,25$ mm;
 Actuating force: ± 10 %

Electrical data

Rated insulation voltage	U_i	250 V AC
Conv. thermal current	I_{the}	10 A
Rated operational voltage	U_e	240 V
Utilization category		AC-15, U_e/I_e 240 V / 3 A
Direct opening action		acc. to IEC/EN 60947-5-1, Annex K
Short-circuit protective device		Fuse 6 A gG

This document will not become the contractual basis; the details included herein do not constitute any descriptions of expected conditions, so that warranties/claims for defects on account of possible variations of the actual qualities from the qualities described herein are explicitly excluded. All rights reserved. Specifications subject to change without notice!

Date of issue: 14.08.2012 / Page 1 of 2
 Document : 6108101039_en / Last update : 1 / 2553-12

Technical Data

Plastic bodied limit switch



Mechanical data

Enclosure	PBT
Actuator	Plunger (St)
Ambient air temperature	-30 °C ... +80 °C
Contact type	1 NC, 1 NO (Zb)
Mechanical life	3 x 10 ⁶ switching cycles
Switching frequency	≤ 100/min
Assembly	2 x M3
Connection	4 flat plug 6,3
Weight	≈ 0,03 kg
Installation position	Operator definable
Protection type	IP00 acc. to EN60529; DIN VDE 0470 T1

Actuation

The push bolt actuator is mainly intended to be actuated along its axis.
Side actuation will considerably reduce switch life.
The switch may not be used as a mechanical stop.

Standards

VDE 0660 T100, DIN EN 60947-1, IEC 60947-1
VDE 0660 T200, DIN EN 60947-5-1, IEC 60947-5-1

EU Conformity

acc. to directive 2006/95/EG

This document will not become the contractual basis; the details included herein do not constitute any descriptions of expected conditions, so that warranties/claims for defects on account of possible variations of the actual qualities from the qualities described herein are explicitly excluded. All rights reserved. Specifications subject to change without notice!

Date of issue: 14.08.2012 / Page 2 of 2
Document : 6108101039_en / Last update : 1 / 2553-12

X-ON Electronics

Largest Supplier of Electrical and Electronic Components

Click to view similar products for [Limit Switches](#) category:

Click to view products by [Altech](#) manufacturer:

Other Similar products are found below :

[6LS2-4PG](#) [5ML1-E1](#) [5ML31](#) [LZG1](#) [LZL1-6C](#) [622EN114-R](#) [622EN18-6](#) [622EN224-6B](#) [622EN230](#) [622EN237-R](#) [622EN69-3](#) [622EN85-RB](#)
[MA-10019](#) [6PA109](#) [7LS51](#) [83547001](#) [83725002](#) [83830001](#) [83840001](#) [83840701](#) [83841001](#) [83870104](#) [83881140](#) [8AS42](#) [8LS10](#) [8LS125-](#)
[4PG](#) [8LS152-4PGN20](#) [914CE16-3A](#) [914CE16-AQ](#) [914CE3-3L1](#) [915PA10](#) [91MCE16-P2O](#) [924CE16-Y3](#) [924CE1-S6](#) [924CE1-T25A](#)
[924CE1-T3](#) [924CE1-T9A](#) [924CE2-T9](#) [924CE31-Y20-X5](#) [924CE31-Y3L1](#) [GL-10054](#) [GL-85710](#) [GL-85714](#) [GLAB26J2B](#) [GLDB03C-6](#)
[GLZ324](#) [PS21R-NT11N7-YK0](#) [D4A-1106N](#) [D4A1201N](#) [D4A-3E02N](#)