

Altech Corp.®

Your Source for Automation & Control Components



Quality
Endorsed
Company

Harsh
Environment
Capability

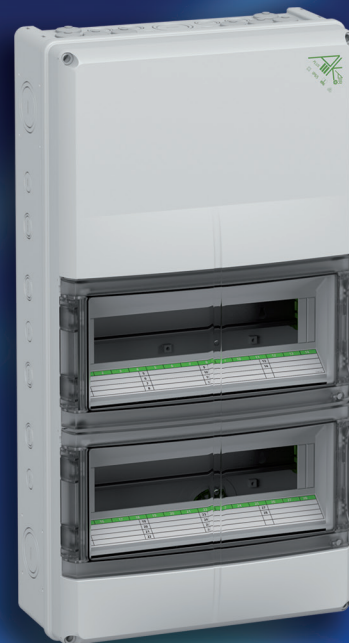

Unique Air
Ventilation System



INDUSTRIAL ENCLOSURES
GEOS & AKIII Series

GEOS

Tough • Flexible • Safe

GEOS - Industrial Outdoor Enclosure

High quality materials and an innovative design make the new GEOS series a universal solution and long lasting enclosure for indoor and outdoor applications. The UV and weather resistance of the high-quality polycarbonate and the new and innovative "Drain Protect" seal system guarantee optimal protection against most environmental influences, as well as rain, cold and heat. Even in tough conditions caused by aggressive atmospheres, oils, greases or mechanical stresses, you can rely on the GEOS enclosure. Certifications for the most varied applications give the user confidence at all times.

Tough

- UV and weather resistant
- Corrosion resistant
- Temperature resistant -35° to 80°C
- Rugged
- High impact resistance - IK 09

Flexible

- Modular component mounting system
- Lightweight
- Easily machined
- Multiple mounting and closure options

Safe

- Drain Protect seal system
- Air ventilation element option
- High protection rating IP67
- Insulated protection
- Safety agency approvals (cULus Type 4X)



TYPE 4X
E254144



Tough

Flexible

Safe

UV and weather resistant

Corrosion resistant

Temperature resistant

Rugged

High impact resistance - IK 09

Modular Component
Mounting System

Light weight

Easily Machined

Multiple Mounting
and Closure Options

Drain Protect seal system

Dust, rain, snow, sprayed water

Air ventilation elements

High protection rating IP67

Insulated protection

The GEOS Family ranging up to 15.75 x 19.69 x 8.9 in.



Modular Component Mounting Features

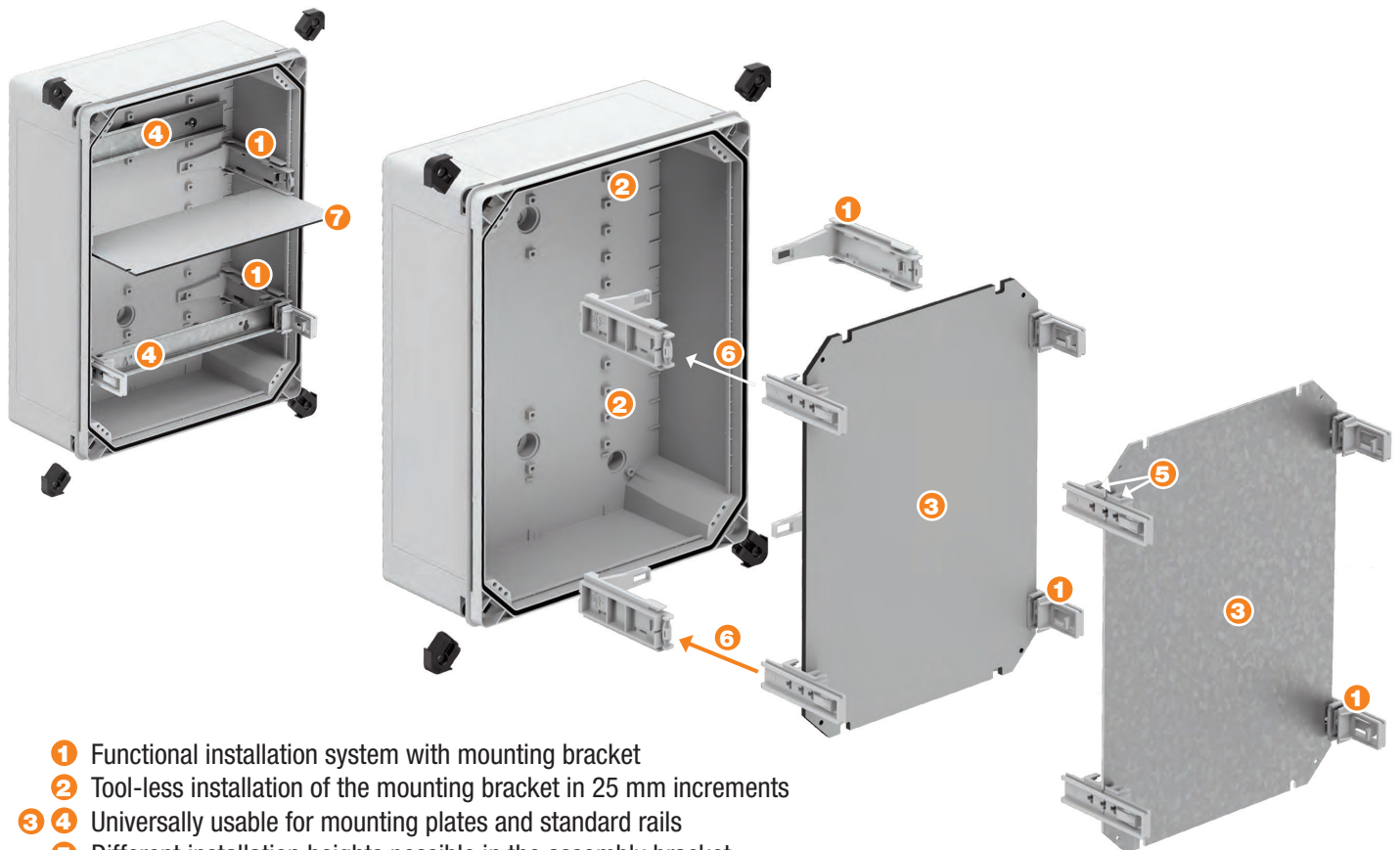

- 1 Functional installation system with mounting bracket
- 2 Tool-less installation of the mounting bracket in 25 mm increments
- 3 4 Universally usable for mounting plates and standard rails
- 5 Different installation heights possible in the assembly bracket
- 6 Subsequent insertion of assembled modules
- 7 Partition walls



All round protection through "Drain Protect"

- Lasting protection against moisture
- Diverts moisture to backside of enclosure

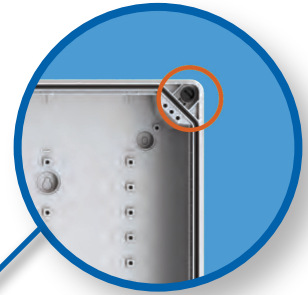

Mounting outside the sealing area

- UL-compliant installation
- Installation of assembled enclosure
- Maintains seal ratings

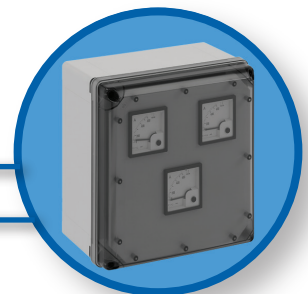

Mounting standoffs in the cover or on top of the base

- Used for installing displays and controls behind the cover

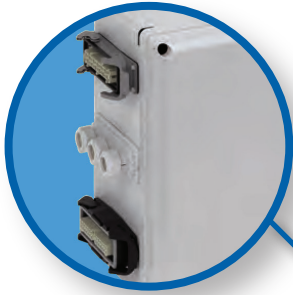

Optimized box dimensions

- Flexible assembly of heavy-duty industrial plug-in connectors.
- For universal use in different applications
- Sidewall will fit Bel Air M40 ventilation set.

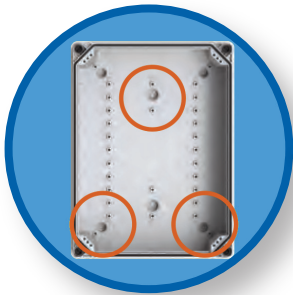

Three-point mounting

- Easy installation via keyhole mounting



1/4 turn screws

- Easy access via 1/4 turn screws as standard
- Conventional screws available, see page 13



Screw position is visibly verifiable.



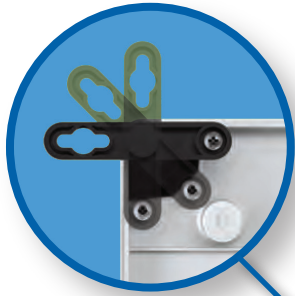

Optional external fastening

- Installation of assembled enclosures
- Available in 2 heights (10 mm or 40 mm)
- Clearance from wall for optimum laying of cables
- Installs at 0°, 45°, 90°

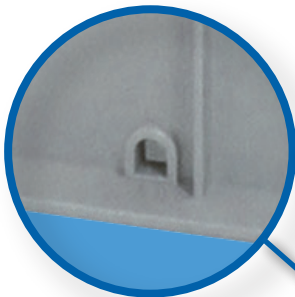

Optional Drain Knockout

- Use of optional drain knockouts will reduce IP rating

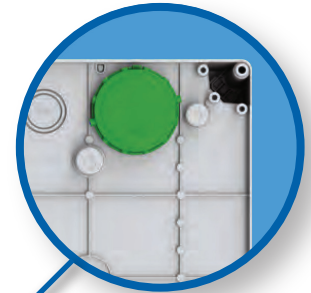
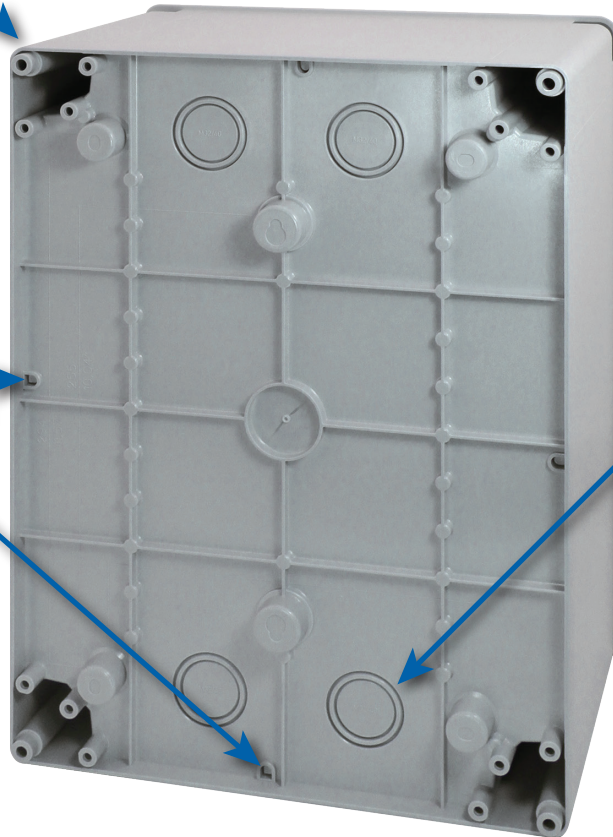

Protection against condensate water

- Preparation for BEL Air M40 ventilation elements (IP65 / UL Type 3R)

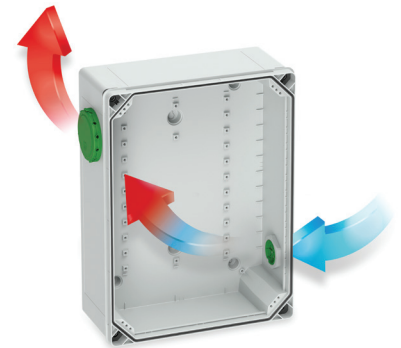

The Ventilation Element

The BEL Air ventilation element prevents condensation, while maintaining a high IP65 protection rating. Any condensation occurring is transported out of the enclosure immediately via air exchange. The continuous and high rate of air exchange allows the interior air to mix constantly with the environmental air and transports the moisture outwards. Air exchange also takes place in environments with almost constant air humidity and temperature, as the air in the interior of the enclosure heats up due to the components. Due to the permanent pressure equalization, all the enclosure parts, such as the seal, are relieved of pressure permanently.



Mounting option BEL Air M40

- M32/40 knockouts in the base
- The wall clearance is suitable for installing BEL Air M40 ventilation elements at ground level
- Option of mounting on the sides of the enclosure (milling of sidewall holes required)

Advantages

- Prevention of condensation while maintaining a high IP 65 protection rating
- High air exchange rate
- 100% Pressure equalization
- 100% Protection against foreign bodies
- Maintenance-free



Cat No. 700-433
GEOS-L 3030-18-o
 with grey cover



Cat No. 701-433
GEOS-L 3030-18-to
 with transparent cover

Description

Empty enclosure - Industrial Quality, suitable for installation in harsh environments and in unprotected outdoor areas.
 Material: glass-fiber reinforced Polycarbonate, grey, similar to RAL 7035.

Size: 300 x 300 x 180 mm
 11.8 x 11.8 x 7.1 in



Dimensions

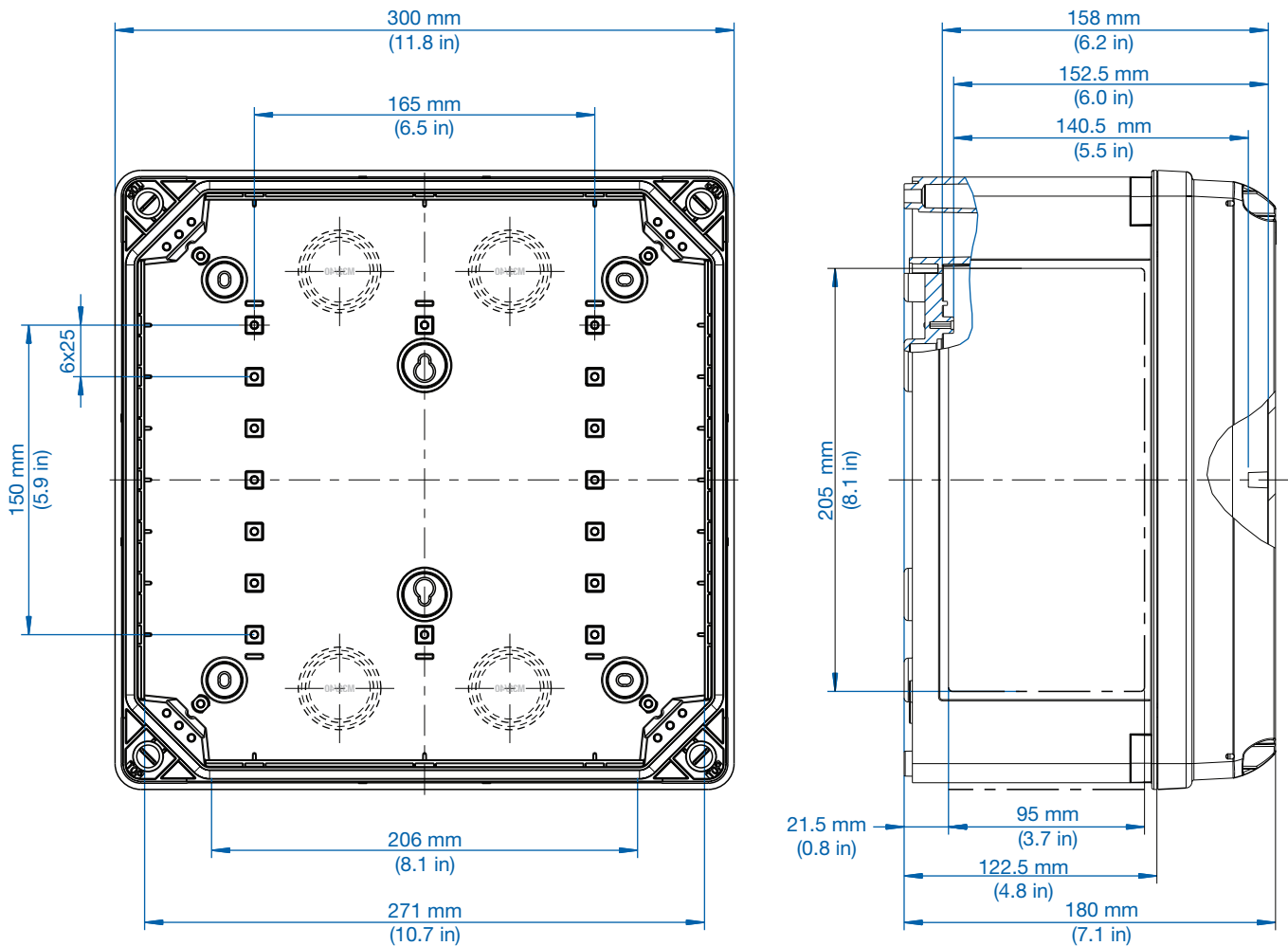

See pages 19-24 for accessories.



Cat No. 700-733
GEOS-L 3030-22-o
 with grey cover

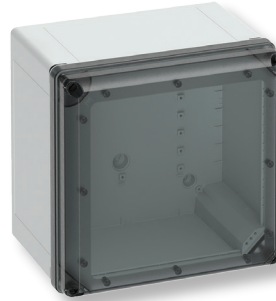

Cat No. 701-733
GEOS-L 3030-22-to
 with transparent cover

Description

Empty enclosure - Industrial Quality, suitable for installation in harsh environments and in unprotected outdoor areas.
 Material: glass-fiber reinforced Polycarbonate, grey, similar to RAL 7035.

Size: 300 x 300 x 226 mm
 11.8 x 11.8 x 8.9 in



Dimensions

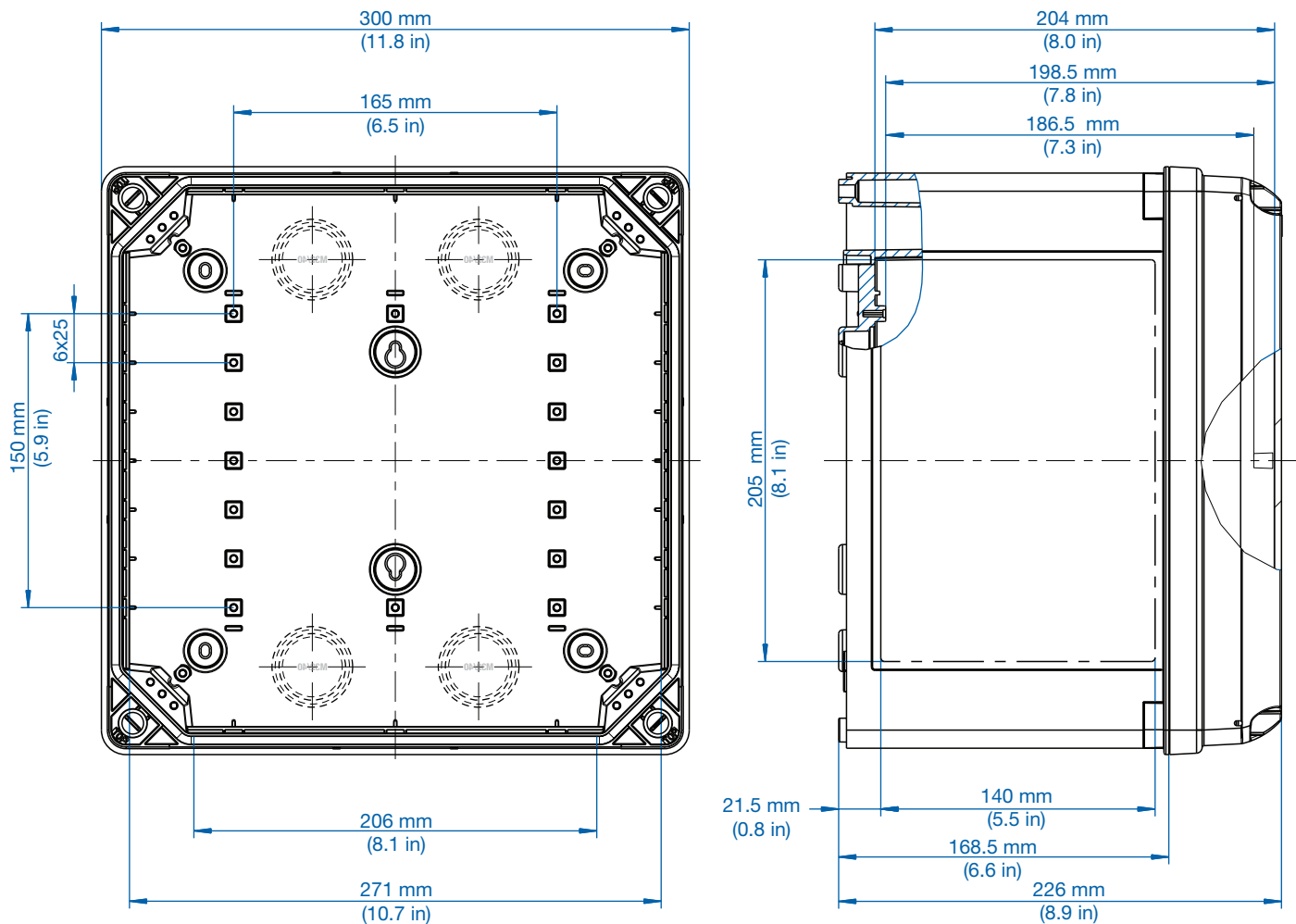

See pages 19-24 for accessories.



Cat No. 700-434
GEOS-L 3040-18-o
 with grey cover



Cat No. 701-434
GEOS-L 3040-18-to
 with transparent cover

Description

Empty enclosure - Industrial Quality, suitable for installation in harsh environments and in unprotected outdoor areas.
 Material: glass-fiber reinforced Polycarbonate, grey, similar to RAL 7035.

Size: 300 x 400 x 180 mm
 11.8 x 15.7 x 7.1 in



Dimensions

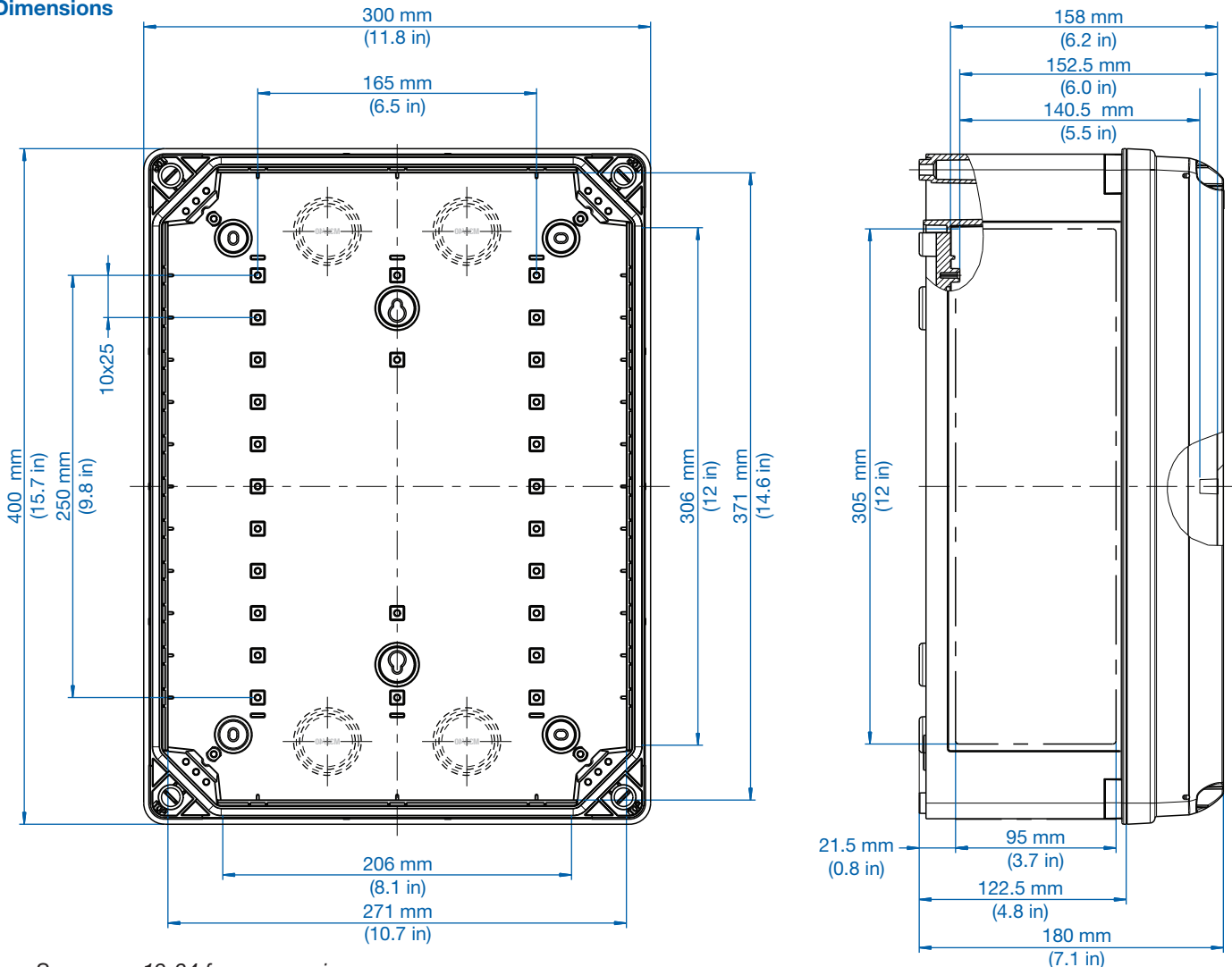

See pages 19-24 for accessories.



Cat No. 700-734
GEOS-L 3040-22-o
 with grey cover

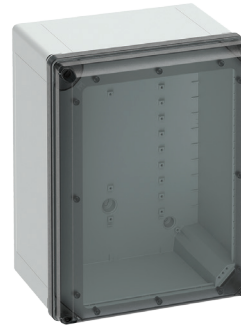

Cat No. 701-734
GEOS-L 3040-22-to
 with transparent cover

Description

Empty enclosure - Industrial Quality, suitable for installation in harsh environments and in unprotected outdoor areas.
 Material: glass-fiber reinforced Polycarbonate, grey, similar to RAL 7035.

Size: 300 x 400 x 226 mm

11.8 x 15.7 x 8.9 in



Dimensions

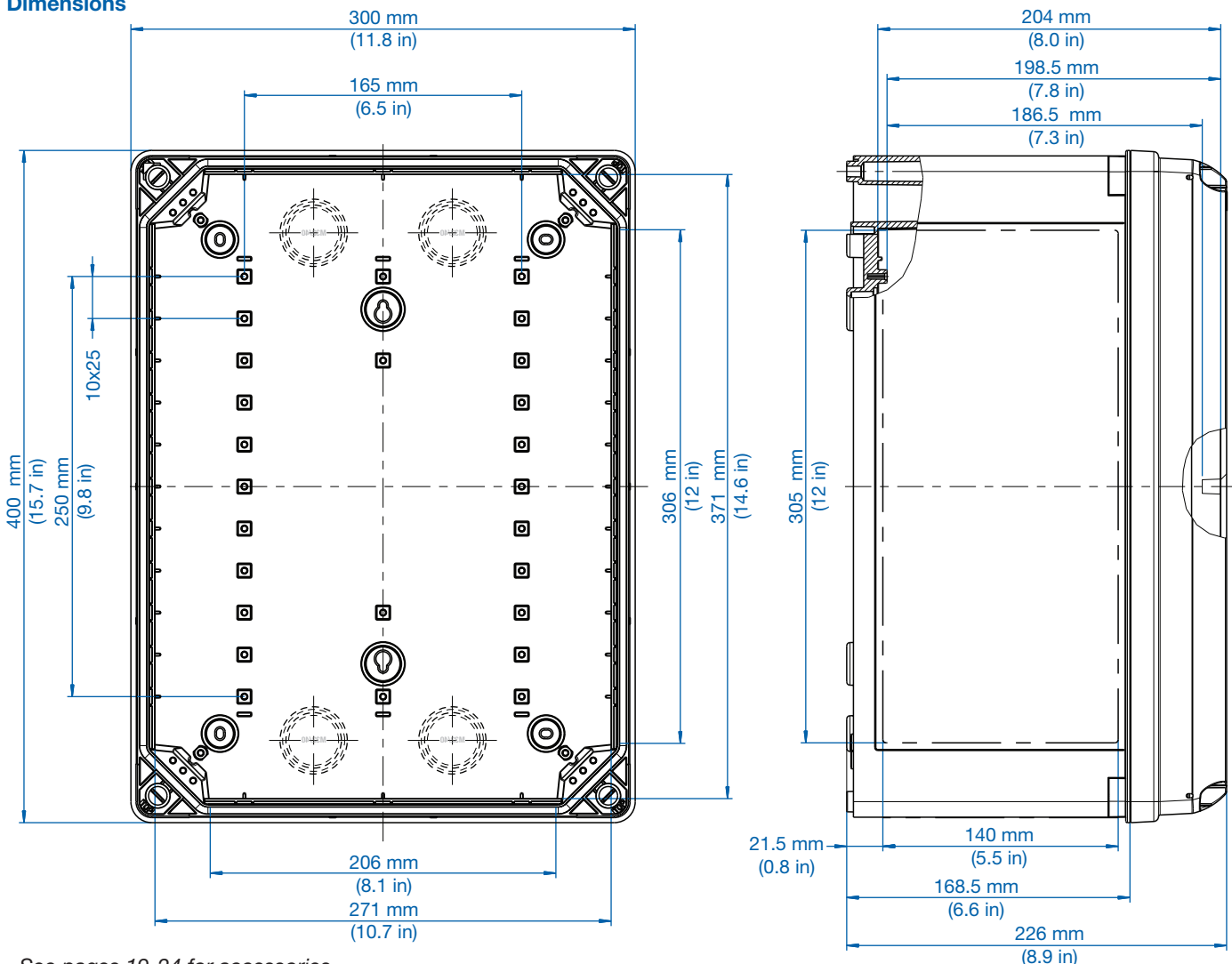

See pages 19-24 for accessories.



Cat No. 700-745
GEOS-L 4050-22-o
 with grey cover



Cat No. 701-745
GEOS-L 4050-22-to
 with transparent cover

Description

Empty enclosure - Industrial Quality, suitable for installation in harsh environments and in unprotected outdoor areas.
 Material: glass-fiber reinforced Polycarbonate, grey, similar to RAL 7035.

Size: 400 x 500 x 226 mm
 15.7 x 19.7 x 8.9 in



Dimensions

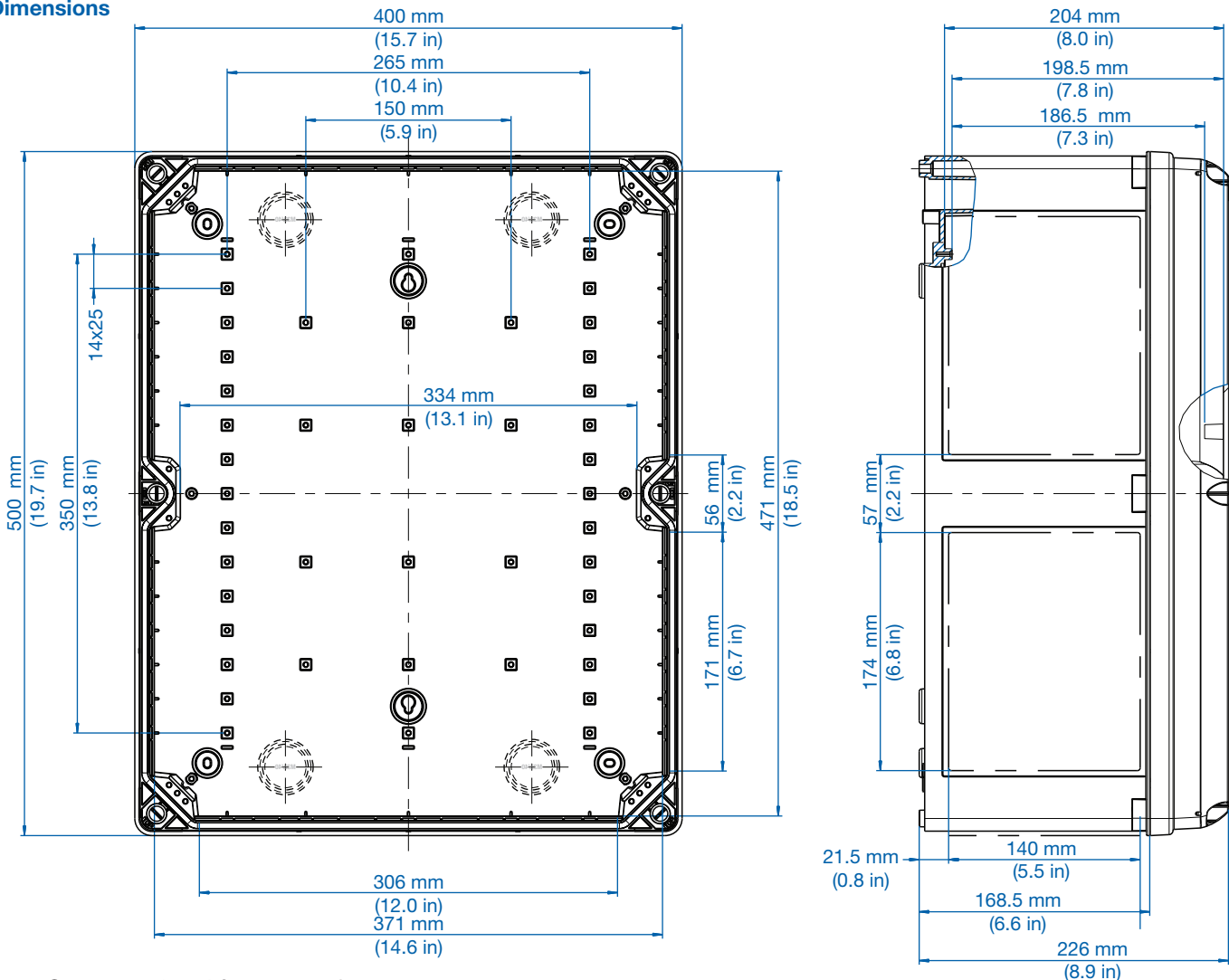

See pages 19-24 for accessories.

GEOS CABINET



Optimized for rough outdoor applications

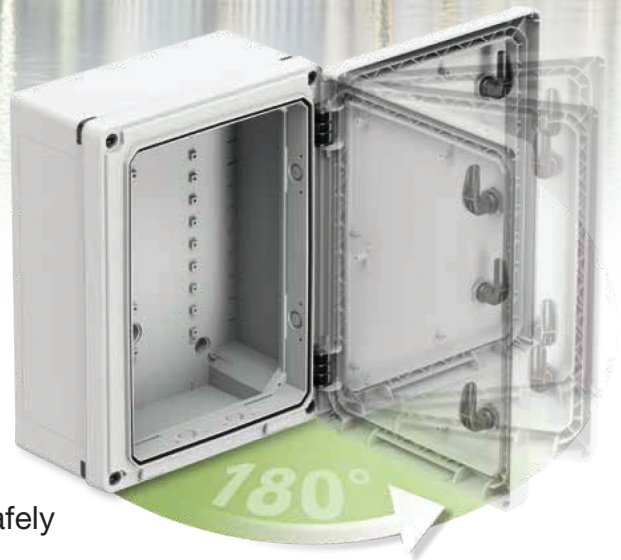
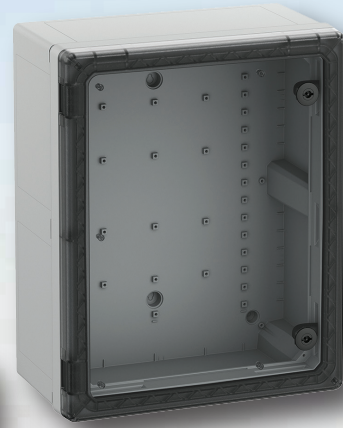

Features

- Cover frame with hinged door
- Horizontal or vertical hinge layout
- Locking system - cam lock (3mm - two bit key)
- Transparent and grey doors
- 3 base sizes
- Up to 2 enclosure heights
- Cabinets tested according to IEC 61439, IEC 62208, UL 50, UL 50E, CSA 22.2
- UL TYPE 4X rated

Advantages

- Can be opened quickly and easily and closed safely
- Good operability of components
- No restrictions for the assembly of internal fittings
- Doors with wide opening angle $> 180^\circ$
- Access to the interior space with standard locking system (3 mm - two-bit key)
- Alternative locking inserts available as accessories
- Doors are guided by frames to be solid
- Doors easily removed or reversed
- Frame accepts accessories (front plates, internal swing doors, contact protection modules, door stops, wiring)



Cat No. 710-433
GEOS-S 3030-18-o
with grey cover



Cat No. 711-433
GEOS-S 3030-18-to
with transparent cover

Description

Cabinet - Industrial Quality, suitable for installation in harsh environments and in exposed outside areas, box and frame: glass-fiber reinforced Polycarbonate, grey, similar to RAL 7035, door: Polycarbonate. Door latch: cam lock with 3mm double-bit insert (interchangeable) in accordance to DIN 43668

Size: 300 x 300 x 180 mm
11.8 x 11.8 x 7.1 in



Dimensions

without door, with frame

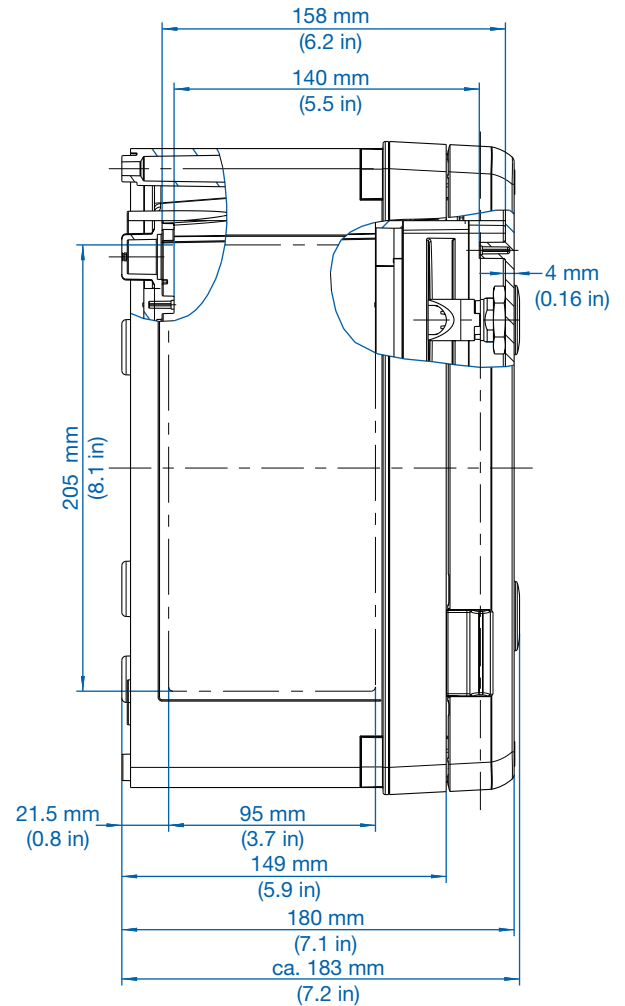
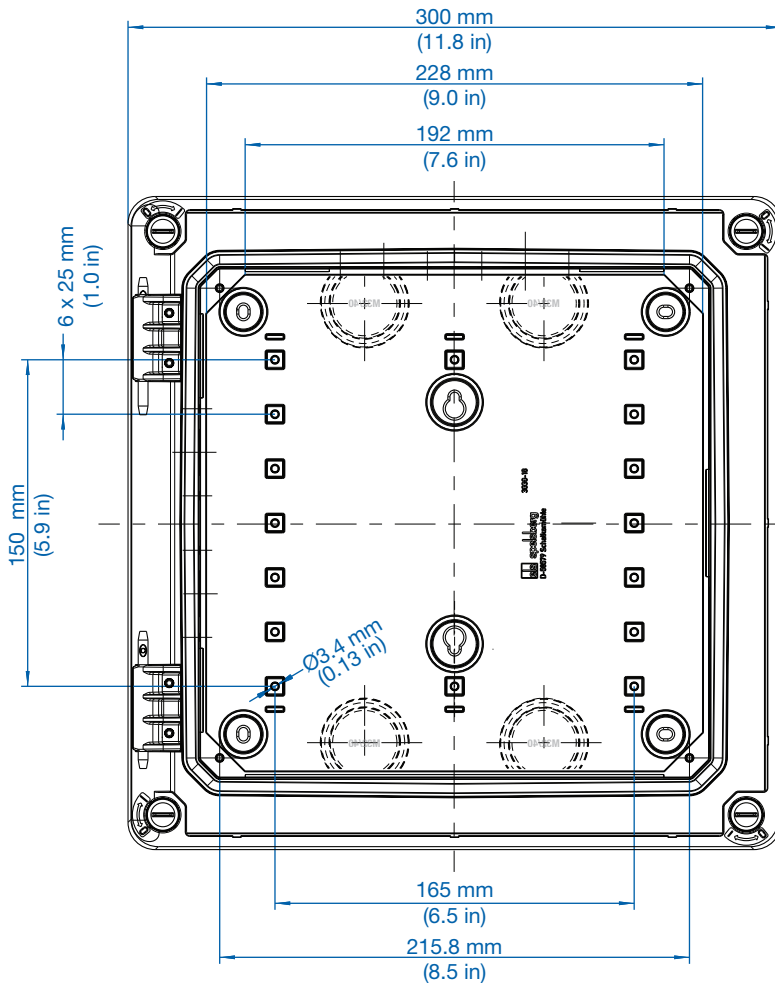

See pages 19-22 and 25-26 for accessories.



Cat No. 710-733
GEOS-S 3030-22-o
with grey cover



Cat No. 711-733
GEOS-S 3030-22-to
with transparent cover

Description

Cabinet - Industrial Quality, suitable for installation in harsh environments and in exposed outside areas, box and frame: glass-fiber reinforced Polycarbonate, grey, similar to RAL 7035, door: Polycarbonate. Door latch: cam lock with 3mm double-bit insert (interchangeable) in accordance to DIN 43668.

Size: 300 x 300 x 226 mm

11.8 x 11.8 x 8.9 in



Dimensions

without door, with frame

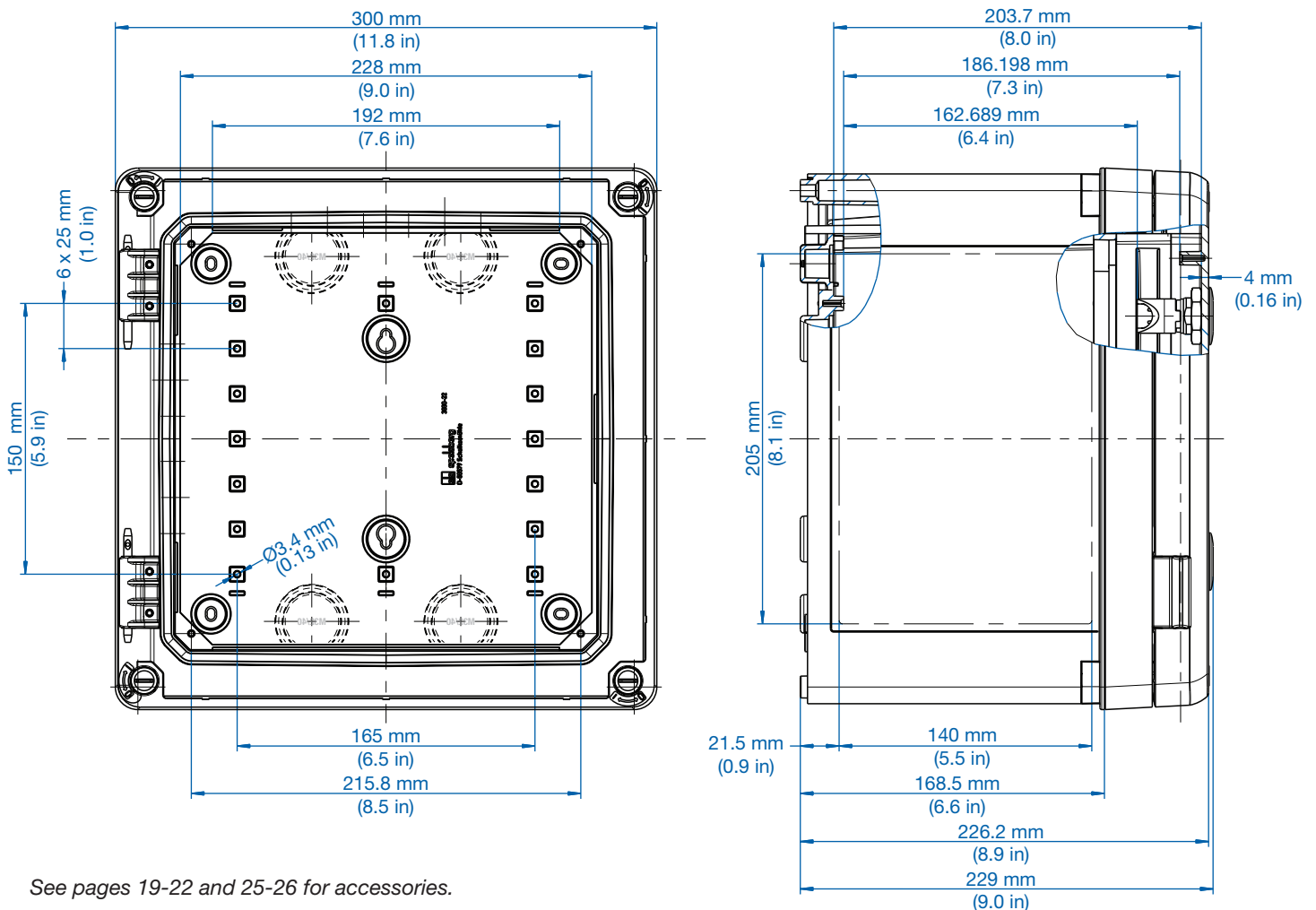

See pages 19-22 and 25-26 for accessories.



Cat No. 710-434
GEOS-S 3040-18-o
with grey cover



Cat No. 711-434
GEOS-S 3040-18-to
with transparent cover

Description

Cabinet - Industrial Quality, suitable for installation in harsh environments and in exposed outside areas, box and frame: glass-fiber reinforced Polycarbonate, grey, similar to RAL 7035, door: Polycarbonate. Door latch: cam lock with 3mm double-bit insert (interchangeable) in accordance to DIN 43668.

Size: 300 x 400 x 180 mm

11.8 x 15.7 x 7.1 in



Dimensions

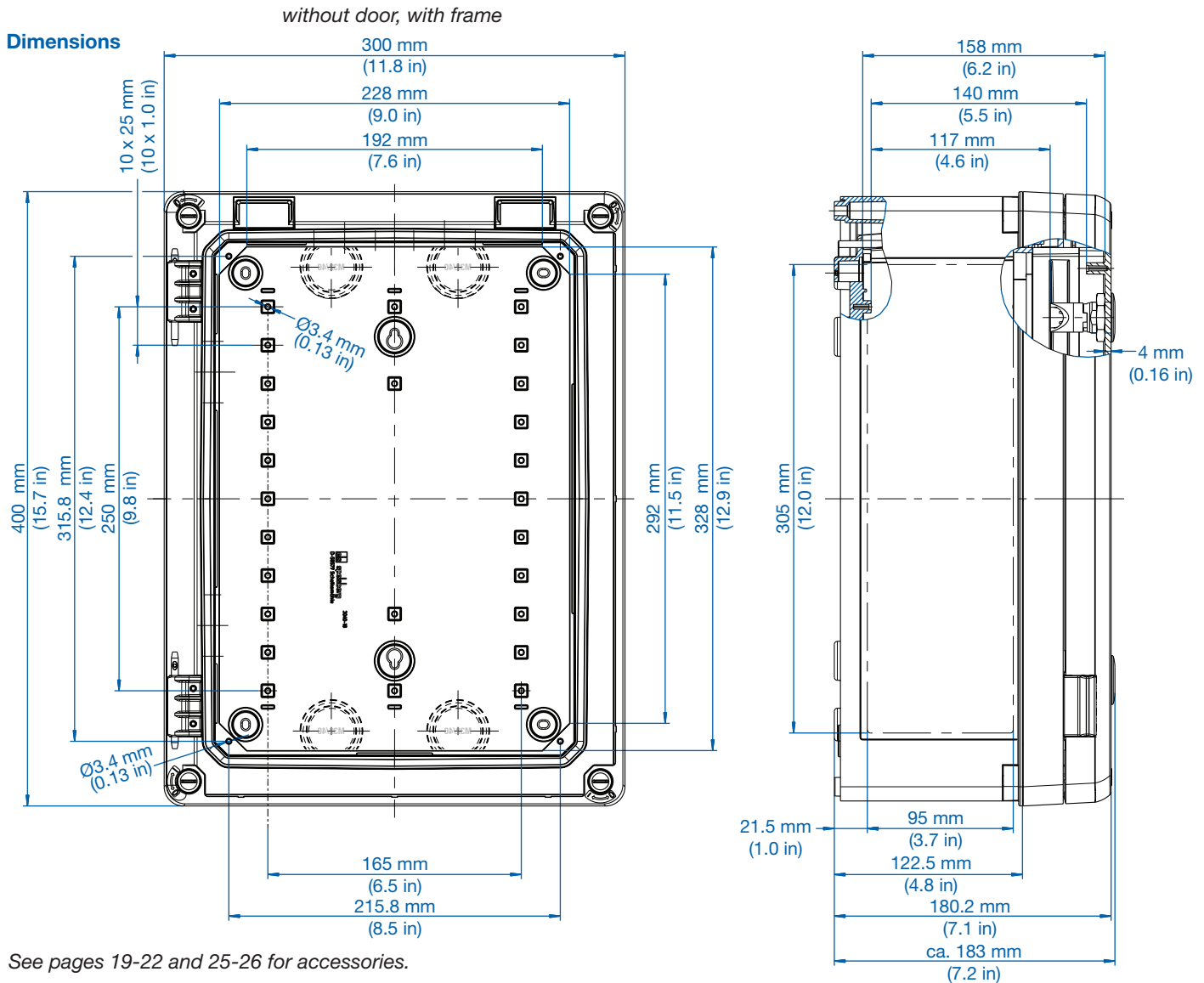

See pages 19-22 and 25-26 for accessories.



Cat No. 710-734
GEOS-S 3040-22-o
with grey cover



Cat No. 711-734
GEOS-S 3040-22-to
with transparent cover

Description

Cabinet - Industrial Quality, suitable for installation in harsh environments and in exposed outside areas, box and frame: glass-fiber reinforced Polycarbonate, grey, similar to RAL 7035, door: Polycarbonate. Door latch: cam lock with 3mm double-bit insert (interchangeable) in accordance to DIN 43668

Size: 300 x 400 x 226 mm

11.8 x 15.7 x 8.9 in



without door, with frame

Dimensions

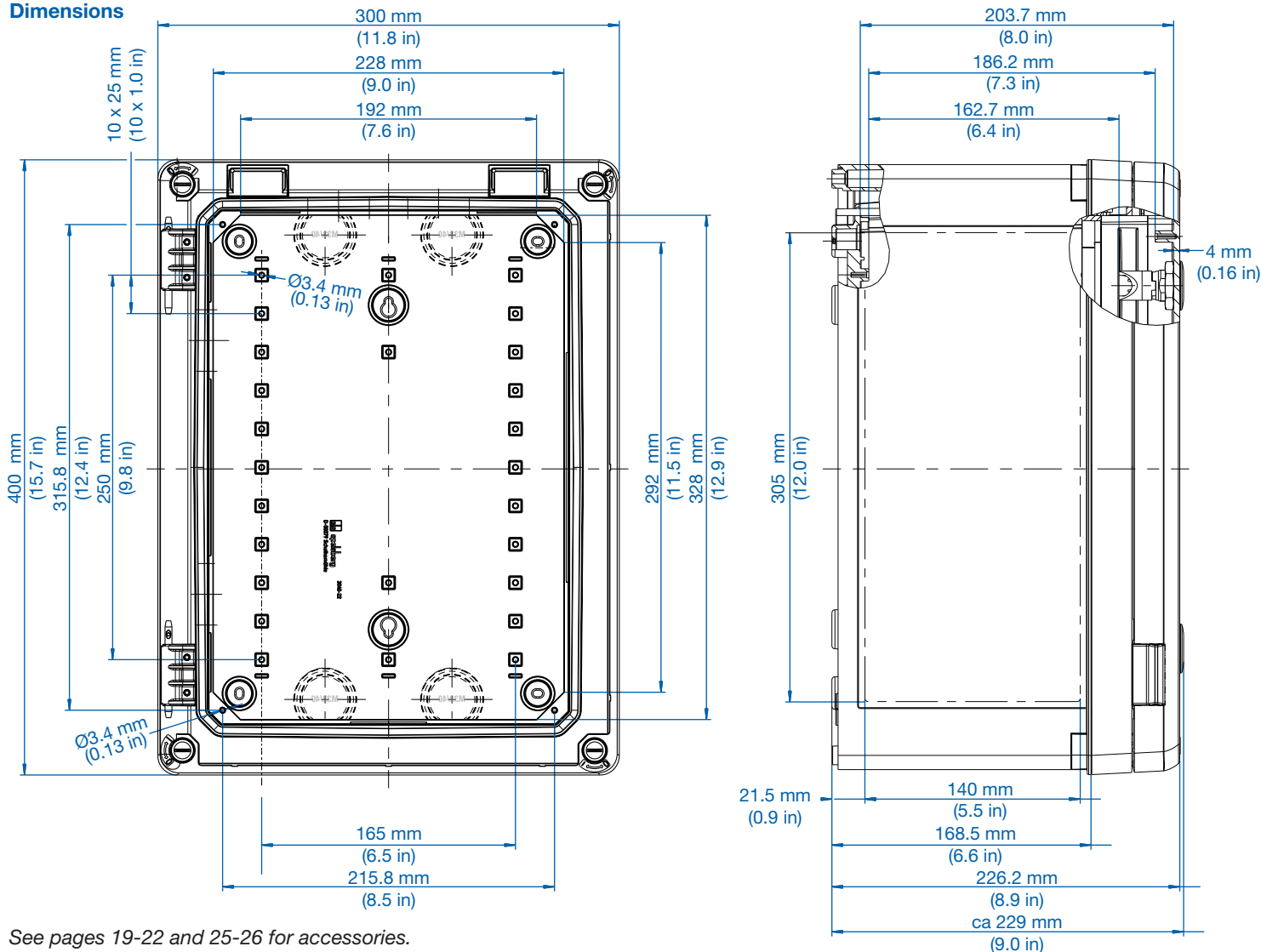

See pages 19-22 and 25-26 for accessories.



Cat No. 710-745
GEOS-S 4050-22-o
with grey cover

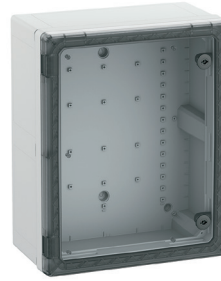

Cat No. 711-745
GEOS-S 4050-22-to
with transparent cover

Description

Cabinet - Industrial Quality, suitable for installation in harsh environments and in exposed outside areas, box and frame: glass-fiber reinforced Polycarbonate, grey, similar to RAL 7035, door: Polycarbonate. Door latch: cam lock with 3mm double-bit insert (interchangeable) in accordance to DIN 43668.



without door, with frame

Size: 400 x 500 x 226 mm

15.7 x 19.7 x 8.9 in

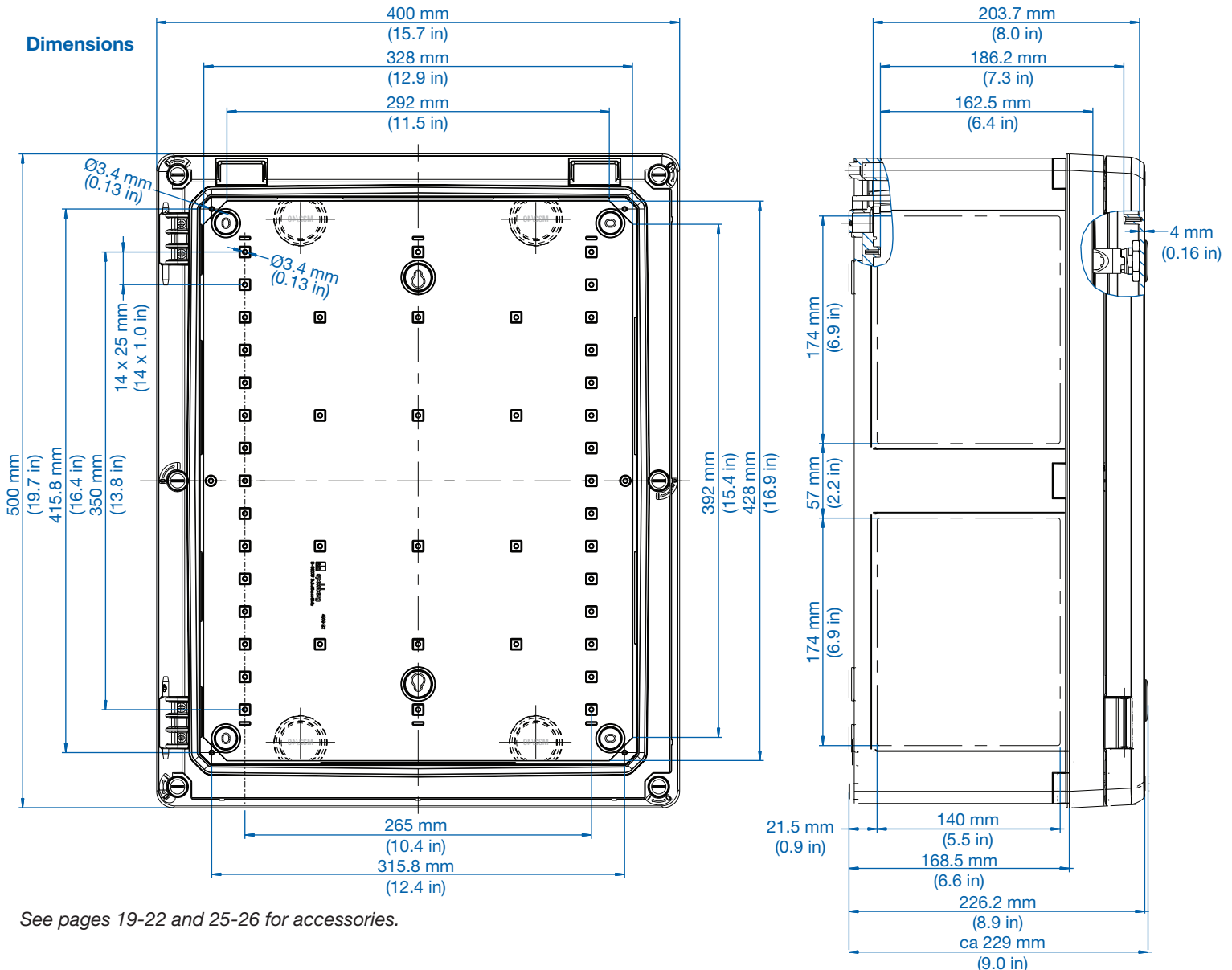

See pages 19-22 and 25-26 for accessories.

Mounting Bracket 35/7.5

Description

Mounting bracket set, for tool-free mounting of standard rails 35 x 7.5 mm and mounting plates at various heights, Set = 4 pieces.

| | No. of Mounting Heights | Enclosure Type | Cat. No. |
|------------|-------------------------|--|----------|
| GEOS MH-18 | 3 | GEOS-L/S 3030-18 GEOS-L/-S 3040-18 GEOS-S 4030-18 | 720-022 |
| GEOS MH-22 | 6 | GEOS-L/S 3030-22 GEOS-L/S 3040-22 GEOS-L/S 4050-22 GEOS-S 4030-22 GEOS-S 5040-22 | 720-023 |

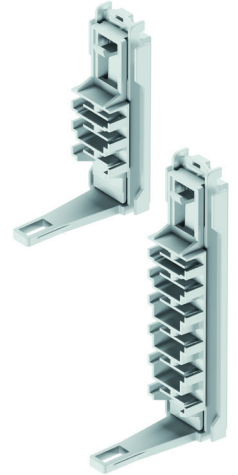

Mounting Bracket 35/15

Description

Mounting bracket set, for tool-free mounting of standard rails 35 x 15 mm and mounting plates at various heights, set = 4 pieces

| | No. of Mounting Heights | Enclosure Type | Cat. No. |
|--------------------|-------------------------|--|----------|
| GEOS MH-18 NS35/15 | 3 | GEOS-L/S 3030-18 GEOS-L/-S 3040-18 GEOS-S 4030-18 | 720-024 |
| GEOS MH-22 NS35/15 | 6 | GEOS-L/S 3030-22 GEOS-L/S 3040-22 GEOS-L/S 4050-22 GEOS-S 4030-22 GEOS-S 5040-22 | 720-025 |

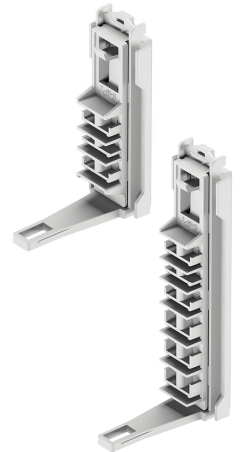

Universal Mounting Bracket

Description

Universal mounting holder set, for mounting of standard rail GEOS NS 35-200 to 400 or other items at various heights along the side of the enclosure, set = 4 pieces

| | No. of Mounting Heights | Enclosure Type | Cat. No. |
|-------------|-------------------------|--|----------|
| GEOS MHU-18 | 4 | GEOS-L/S 3030-18 GEOS-L/S 3040-18 GEOS-S 4030-18 | 720-026 |
| GEOS MHU-22 | 8 | GEOS-L/S 3030-22 GEOS-L/S 3040-22 GEOS-L/S 4050-22 GEOS-S 4030-22 GEOS-S 5040-22 | 720-027 |



Standard Rails - 35 x 7.5 mm

Description

Standard rails according to DIN EN 60715, 35 x 7.5 mm, including fixing screws for floor mounting. Optional mounting at various heights by means of mounting bracket.



| | Enclosure Side | Length | Enclosure Type | Cat. No. |
|---------------|----------------|--------|---|----------|
| GEOS NS35-250 | 300 mm | 250 mm | GEOS-L/S 3030 GEOS-L/S 3040 GEOS-S 4030 | 720-031 |
| GEOS NS35-350 | 400 mm | 350 mm | GEOS-L/S 3040 GEOS-L/S 4050 GEOS-S 5040 | 720-032 |
| GEOS NS35-450 | 500 mm | 450 mm | GEOS-L/S 4050 GEOS-S 5040 | 720-033 |

Standard Rails - 35 x 15 mm

Description

Standard rail according to DIN EN 60715, 35 x 15 mm, including fixing screws, for floor mounting, optional mounting with mounting bracket at various heights possible



| | Enclosure Side | Length | Enclosure Type | Cat. No. |
|------------------|----------------|--------|---|----------|
| GEOS NS35/15-250 | 300 mm | 250 mm | GEOS-L/S 3030 GEOS-L/S 3040 GEOS-S 4030 | 720-036 |
| GEOS NS35/15-350 | 400 mm | 350 mm | GEOS-L/S 3040 GEOS-L/S 4050 GEOS-S 5040 | 720-037 |
| GEOS NS35/15-450 | 500 mm | 450 mm | GEOS-L/S 4050 GEOS-S 5040 | 720-038 |

Standard Rail - GEOS 4050 mid

Description

Standard rail according to DIN EN 60715, width 35 mm at heights 7.5 and 15 mm, including fastening screws, for floor-mounting in GEOS 4050 (middle position), mounting using mounting bracket in different heights not possible



| | Description | Cat. No. |
|------------------|---|----------|
| GEOS NS35-327 | for GEOS-L/S 4050 middle position, floor mount only, length, 327mm, height, 7.5mm | 720-034 |
| GEOS NS35/15-327 | for GEOS-L/S 4050 middle position, floor mount only, length, 327mm, height, 15mm | 720-039 |

Universal Mounting Holder Standard Rail

Description

Standard rail according to DIN EN 60715, 35 x 7.5 mm, including fastening screws, for mounting on GEOS universal mounting holder MHU



| | Enclosure Side | Length | Enclosure Type | Cat. No. |
|---------------|----------------|--------|--------------------------------|----------|
| GEOS NS35-200 | 300 mm | 200 mm | GEOS-L/S 3030 GEOS-L/S 3040 | 720-081 |
| GEOS NS35-300 | 400 mm | 300 mm | GEOS-L/S 3040 GEOS-L/S 4050 | 720-082 |
| GEOS NS35-400 | 500 mm | 400 mm | GEOS-L/S 4050 | 720-083 |

Carrying frame NS35

Description

Carrying frame with standard rails 35 mm, including fixing screws for floor mounting. Optional mounting by means of mounting brackets possible in various heights, non shock protection, use with contact protection covers or stand alone

| | DIN Rails | Enclosure Type | Cat. No. |
|-------------------------|---------------------------------------|---|----------|
| GEOS TGS 3040-2 | 2 rows 35x7.5, 12 CB units per row | GEOS-L 3040 vertical and GEOS-S 3040 | 720-062 |
| GEOS TGS 4050-3 | 3 rows 35x7.5, 18 CB units per row | GEOS-L 4050 vertical and GEOS-S 4050 | 720-064 |
| GEOS TGS 4050-2 | 2 rows 35x7.5 21 CB units per row | GEOS-L 4050 horizontal and GEOS-S 5040 | 720-065 |
| GEOS TGS NS35/15 3040-2 | 2 rows 35x15 12 CB units per row | GEOS-L 3040 vertical and GEOS-S 3040 | 720-072 |
| GEOS TGS NS35/15 4050-3 | 3 rows 35x15 18 CB units per row | GEOS-L 4050 vertical and GEOS-S 4050 | 720-074 |
| GEOS TGS NS35/15 4050-2 | 2 rows 35x15 21 CB units per row | GEOS-L 4050 horizontal and GEOS-S 5040 | 720-073 |



Mounting Plate Insulating Material

Description

Mounting plate made from insulating material, including fixing screws for floor mounting. Optional mounting at various heights by means of mounting bracket.

| | Dimensions | Enclosure Type | Cat. No. |
|---------------|------------------|-------------------------|----------|
| GEOS MPI-3030 | 250 x 250 x 5 mm | GEOS-L/S 3030-18 and 22 | 720-003 |
| GEOS MPI-3040 | 250 x 350 x 5 mm | GEOS-L/S 3040-18 and 22 | 720-004 |
| GEOS MPI-4050 | 350 x 450 x 5 mm | GEOS-L/S 4050-22 | 720-005 |

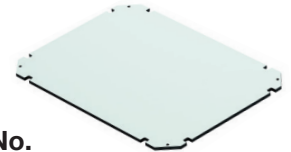

Mounting Plate Galvanized Steel

Description

Mounting plate made from galvanized steel, including fixing screws for floor mounting. Optional mounting at various heights by means of mounting bracket.

| | Dimensions | Enclosure Type | Cat. No. |
|---------------|------------------|-------------------------|----------|
| GEOS MPS-3030 | 250 x 250 x 2 mm | GEOS-L/S 3030-18 and 22 | 720-013 |
| GEOS MPS-3040 | 250 x 350 x 2 mm | GEOS-L/S 3040-18 and 22 | 720-014 |
| GEOS MPS-4050 | 350 x 450 x 2 mm | GEOS-L/S 4050-22 | 720-015 |

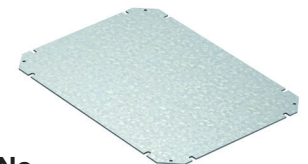

Ventilation Elements

Description

BEL Air ventilation elements set, for preventing condensate water formation in the enclosures, for vertical installation in the enclosure with appropriate knockout, at least two ventilation elements are required per enclosure. Air exchange rate: 30 l/day / Set. *UL Type 3R when using ventilation elements.*

| | Cat. No. |
|-------------------------------|----------|
| BEL Air M40 Set = 2 pieces | 263-440 |



External Mounting Tabs

Description

Set of external mounting tabs made of plastic, can be mounted at an angle of 0°, 45° or 90°, Color: black, Set = 4 pieces.

UL Type 12K when using external mounting tabs.

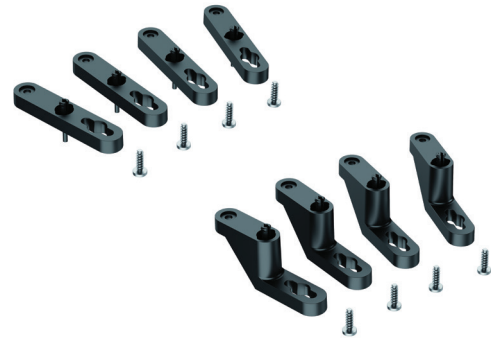

| | Wall clearance | Cat. No. |
|-------------|----------------|----------|
| GEOS ABL-10 | 10 mm | 720-020 |
| GEOS ABL-40 | 40 mm | 720-021 |

External Mounting Bracket

Description

External mounting bracket set made of V4A stainless steel, mounting possible at an angle of 0° or 90°, set = 4 pieces

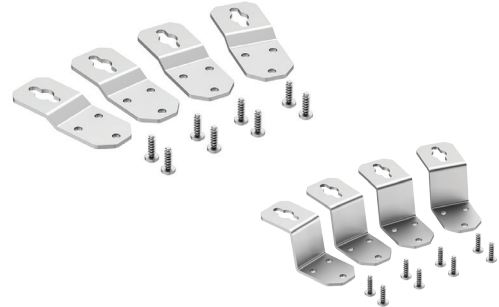

| | Wall Clearance | Cat. No. |
|----------------|----------------|----------|
| GEOS ABL-10/ES | 10 mm | 720-075 |
| GEOS ABL-40/ES | 40 mm | 720-076 |

Pole Mount Kit

Description

Pole mount kit made of hot-dip galvanized steel, Set = 2 pieces.

Requires ring clamp set.

| | Mounting Side | Dimensions | Cat. No. |
|-------------|---------------|------------------|----------|
| GEOS MSS-30 | 300 mm | 35 x 286 x 40 mm | 720-050 |
| GEOS MSS-40 | 400 mm | 35 x 386 x 40 mm | 720-051 |
| GEOS MSS-50 | 500 mm | 35 x 486 x 40 mm | 720-052 |



example pole application



Ring Clamp Set

Description

Ring clamp set made of stainless steel V2A, used in conjunction with pole mount kit GEOS MSS, Set = 2 pieces.

| | Pole Diameter | Cat. No. |
|-------------|---------------|----------|
| SRS 60-90 | 60 to 90 mm | 720-040 |
| SRS 90-150 | 90 to 150 mm | 720-041 |
| SRS 150-210 | 150 to 210 mm | 720-042 |



Back Cover Plate

Description

Optional plate made of V2A stainless steel to cover the back of the GEOS housing when using the GEOS MSS pole mount kit. Blocks access to rear knockouts and gives finished look to back of enclosure when mounted. Set = 1 piece.

| | Enclosure Type | Dimensions | Cat. No. |
|--------------|----------------|------------------|----------|
| GEOS DP-3030 | GEOS-L/S 3030 | 293 x 293 x 2 mm | 720-130 |
| GEOS DP-3040 | GEOS-L/S 3040 | 293 x 393 x 2 mm | 720-131 |
| GEOS DP-4050 | GEOS-L/S 4050 | 393 x 493 x 2 mm | 720-132 |



Standard Enclosure Front Mounting Plate

Description

Plate for mounting on top of enclosure base, made from insulating material, including fixing screws. Used for installing indicator and switching elements.



| | Dimensions | Enclosure Type | Cat. No. |
|----------------|------------------|-----------------------|----------|
| GEOS-L EP-3030 | 276 x 276 x 4 mm | GEOS-L 3030-18 and 22 | 721-013 |
| GEOS-L EP-3040 | 276 x 376 x 4 mm | GEOS-L 3040-18 and 22 | 721-014 |
| GEOS-L EP-4050 | 376 x 476 x 4 mm | GEOS-L 4050-22 | 721-015 |

Standard Enclosure Cover Plate

Description

Plate for mounting to inside of cover, made from insulating material, including fixing screws. Used for installing indicator and switching elements.



| | Dimensions | Enclosure Type | Cat. No. |
|-----------------|------------------|-----------------------|----------|
| GEOS-L EPD-3030 | 276 x 276 x 4 mm | GEOS-L 3030-18 and 22 | 721-016 |
| GEOS-L EPD-3040 | 276 x 376 x 4 mm | GEOS-L 3040-18 and 22 | 721-017 |
| GEOS-L EPD-4050 | 376 x 476 x 4 mm | GEOS-L 4050-22 | 721-018 |

Standard Enclosure Partition Wall

Description

Partition wall made of insulating material, for dividing the enclosure, including support.

| | Enclosure Side | Enclosure Type | Cat. No. |
|-----------------|----------------|----------------|----------|
| GEOS-L TW 30-18 | 300 mm | GEOS 3030-18 | 721-032 |
| | | GEOS 3040-18 | |
| GEOS-L TW 30-22 | 300 mm | GEOS 3030-22 | 721-033 |
| | | GEOS 3040-22 | |
| GEOS-L TW 40-18 | 400 mm | GEOS 3040-18 | 721-034 |
| GEOS-L TW 40-22 | 400 mm | GEOS 3040-22 | 721-035 |
| | | GEOS 4050-22 | |
| GEOS-L TW 50-22 | 500 mm | GEOS 4050-22 | 721-036 |

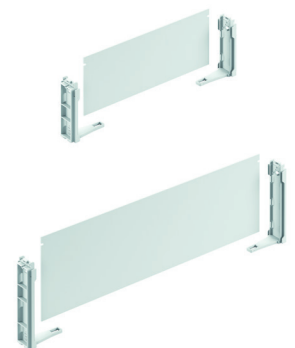

Standard Enclosure Contact Protection Cover

Description

Protective cover for rail-mounted devices, including fixing screws, for mounting in GEOS-L empty enclosure

| | Description | Enclosure Type | Cat. No. |
|-------------------|--------------------|-----------------------|----------|
| GEOS-L BSA 3030-1 | 1-row, 12 CB units | GEOS-L 3030-18 and 22 | 721-051 |
| GEOS-L BSA 3040-1 | 1-row, 18 CB units | GEOS-L 3040-18 and 22 | 721-053 |
| GEOS-L BSA 3040-2 | 2 row, 24 CB units | GEOS-L 3040-18 and 22 | 721-052 |
| GEOS-L BSA 4050-2 | 2 row, 42 CB units | GEOS-L 4050-22 | 721-055 |
| GEOS-L BSA 4050-3 | 3 row, 54 CB units | GEOS-L 4050-22 | 721-054 |

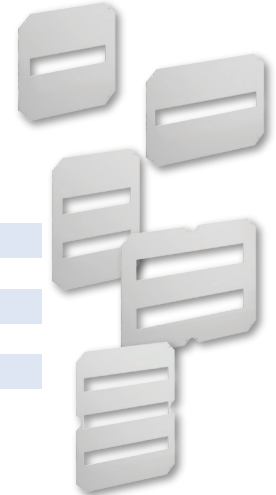

Standard Enclosure Cover Retainer

Description

Cover retainer made of stainless steel with fastening screws, mountable retroactively

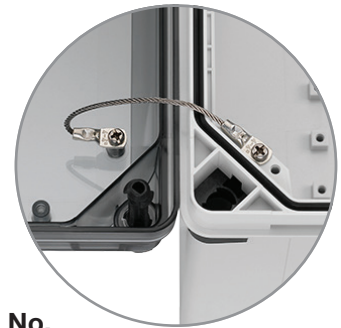

| | Description | Cat. No. |
|------------|---|----------|
| GEOS-L DVS | For GEOS empty enclosures, prevents cover from falling down unintentionally, set = 2 pieces | 721-037 |

Standard Enclosure Conventional Lid Screws

Description

When conventional screws are preferred over the included 1/4 turn screws this kit can be used to replace the included set.

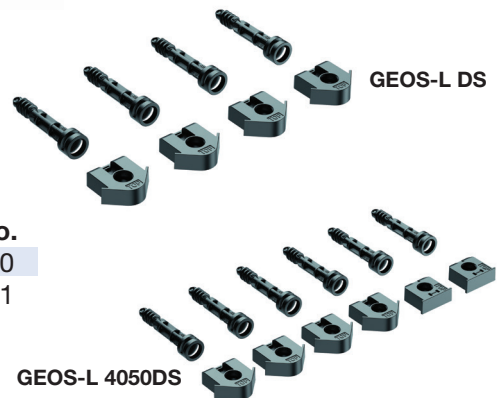

| | Enclosure size | Screw Qty. | Cat. No. |
|---------------|----------------|------------|----------|
| GEOS-L DS | GEOS 3030/3040 | 4 | 721-040 |
| GEOS-L 4050DS | GEOS 4050 | 6 | 721-041 |

Cabinet Front Plate

Description

Front plate made of insulating material for the frame of GEOS cabinets, including fixing screws, used for the installation of command and signaling devices

| | Dimensions | Cabinet Type | Cat. No. |
|----------------------|------------------|--|----------|
| GEOS-S EPR 3030 | 231 x 231 x 4 mm | GEOS-S 3030-18 and 22 | 722-013 |
| GEOS-S EPR 3040/4030 | 231 x 331 x 4 mm | GEOS-S 3040-18 and 22 GEOS-S 4030-18 and 22 | 722-014 |
| GEOS-S EPR 4050/5040 | 231 x 431 x 4 mm | GEOS-S 4050-22 GEOS-S 5040-22 | 722-015 |



Transparent Cabinet Front Plate

Description

Front plate made of clear transparent polycarbonate for the frame of GEOS cabinets, including fixing screws, used to protect fixtures located in the cabinet while at the same time ensuring visibility

| | Dimensions | Cabinet Type | Cat. No. |
|------------------------|------------------|--|----------|
| GEOS-S EPR-t 3030 | 231 x 231 x 4 mm | GEOS-S 3030-18 and 22 | 722-103 |
| GEOS-S EPR-t 3040/4030 | 231 x 331 x 4 mm | GEOS-S 3040-18 and 22 GEOS-S 4030-18 and 22 | 722-104 |
| GEOS-S EPR-t 4050/5040 | 231 x 431 x 4 mm | GEOS-S 4050-22 GEOS-S 5040-22 | 722-105 |



Cabinet Door Mounting Plate

Description

Mounting plate made of insulating material for the door of GEOS cabinets, including fixing screws, used for installation of indicating elements and displays

| | Dimensions | Cabinet Type | Cat. No. |
|-----------------|------------------|-----------------------|----------|
| GEOS-S EPT 3030 | 150 x 225 x 4 mm | GEOS-S 3030-18 and 22 | 722-023 |
| GEOS-S EPT 3040 | 150 x 325 x 4 mm | GEOS-S 3040-18 and 22 | 722-024 |
| GEOS-S EPT 4030 | 250 x 225 x 4 mm | GEOS-S 4030-18 and 22 | 722-025 |
| GEOS-S EPT 4050 | 250 x 425 x 4 mm | GEOS-S 4050-22 | 722-026 |
| GEOS-S EPT 5040 | 175 x 325 x 4 mm | GEOS-S 5040-22 | 722-027 |



Cabinet Partition Wall

Description

Cabinet partition wall, made of insulating material, for dividing the enclosure, including support.

| | Enclosure Side | Cabinet Type | Cat. No. |
|-----------------|----------------|---|----------|
| GEOS-S TW 30-18 | 300 mm | GEOS-S 3030-18, GEOS-S 3040-18, GEOS-S 4030-18 | 722-032 |
| GEOS-S TW 30-22 | 300 mm | GEOS-S 3030-22, GEOS-S 3040-22, GEOS-S 4030-22 | 722-033 |
| GEOS-S TW 40-18 | 400 mm | GEOS-S 3040-18, GEOS-S 4030-18 | 722-034 |
| GEOS-S TW 40-22 | 400 mm | GEOS-S 3040-22, GEOS-S 4030-22, GEOS-S 4050-22, GEOS-S 5040-22 | 722-035 |
| GEOS-S TW 50-22 | 500 mm | GEOS-S 4050-22, GEOS-S 5040-22 | 722-036 |

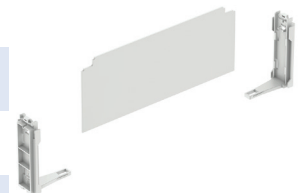

Cabinet Door Stop

Description

Door stop for securing the open cabinet door in two possible positions

| | Cabinet Type | Cat. No. |
|------------|---------------------|----------|
| GEOS-S TFS | all GEOS-S cabinets | 722-070 |



Cabinet Inner Door

Description

Inner door made of insulating material for installation in GEOS cabinets, including fixing material and rotary twist lock, 3mm double bit, used for installation of displays, command and signaling devices, material thickness: 4 mm



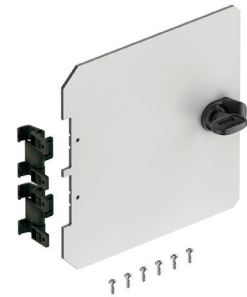

| | Cabinet Type | Cat. No. |
|----------------|--------------|----------|
| GEOS-S IT 3030 | GEOS-S 3030 | 722-003 |
| GEOS-S IT 3040 | GEOS-S 3040 | 722-004 |
| GEOS-S IT 4030 | GEOS-S 4030 | 722-005 |
| GEOS-S IT 4050 | GEOS-S 4050 | 722-006 |
| GEOS-S IT 5040 | GEOS-S 5040 | 722-007 |



Cabinet Twist Lock Set

Description

Twist lock set for installation in GEOS-S cabinets as replacements for standard 3mm double-bit insert, set = 2 pieces

| | Description | Cat. No. |
|-----------------|---|----------|
| GEOS-S DRS-DB/5 |  Double-bit 5 mm mandrel | 722-051 |
| GEOS-S DRS-VK/8 |  Square 8 mm | 722-052 |
| GEOS-S DRS-DK/8 |  Triangle 8 mm | 722-053 |
| GEOS-S DRS-KB |  Toggle handle | 722-054 |
| GEOS-S DRS-SZ |  Countersunk slot | 722-055 |



Cabinet Contact Protection Module

Description

Contact protection modules for tool-free installation in the frame of GEOS cabinets, grey plastic similar to RAL 7035

| | Description | Cabinet Type | Cat. No. |
|------------------------|---|-----------------------|----------|
| GEOS-S BSM 3030-9 | 9 CB units, single-row | GEOS-S 3030-18 and 22 | 722-083 |
| GEOS-S BSM 3030 | Solid, without openings | GEOS-S 3030-18 and 22 | 722-084 |
| GEOS-S BSM 3040-9 | 9 CB units, single-row | GEOS-S 3040-18 and 22 | 722-087 |
| GEOS-S BSM 3040 | Solid, without openings | GEOS-S 3040-18 and 22 | 722-088 |
| GEOS-S BSM 4050-15 | 15 CB units, single-row, mounting on top/bottom | GEOS-S 4050-22 | 722-091 |
| GEOS-S BSM 4050-15/MIT | 15 CB units, single-row, mounting in middle | GEOS-S 4050-22 | 722-092 |
| GEOS-S BSM 4050 | Solid, without openings | GEOS-S 4050-22 | 722-093 |
| GEOS-S BSM 3040-9/2 | 18 CB units, double-row Set consisting of 2 x articles 722-087 | GEOS-S 3040-18 and 22 | 722-097 |
| GEOS-S BSM 4050-15/3 | 45 CB units, triple-row Set consisting of 2 x articles 722-091 and 1 x article 722-092 | GEOS-S 4050-22 | 722-098 |



Cabinet Cover Screw Set

Description

Cabinet cover screw set for replacements

| | Cabinet Type | Cat. No. |
|--------------------|-----------------------------|----------|
| GEOS-S 3030 S | GEOS-S 3030 | 722-040 |
| GEOS-S 3040/4030 S | GEOS-S 3040 and GEOS-S 4030 | 722-041 |
| GEOS-S 4050/5040 S | GEOS-S 4050 and GEOS-S 5040 | 722-042 |



X-ON Electronics

Largest Supplier of Electrical and Electronic Components

Click to view similar products for [Enclosures for Industrial Automation](#) category:

Click to view products by [Altech](#) manufacturer:

Other Similar products are found below :

[116-508](#) [130-008](#) [190-005](#) [2202307](#) [2901699](#) [2790318](#) [WM011RI,BK](#) [WM052I,GY](#) [WM093RI,BK](#) [5030266](#) [WM053R,BK](#) [WM032I,BK](#)
[2909989](#) [120-908](#) [150-007](#) [790-207](#) [2200095](#) [111-012](#) [127-408](#) [802-407](#) [115-401](#) [795-001](#) [790-211](#) [733-820](#) [BW67DBKCSYL](#)
[CX68DBKANG](#) [CXL68DBKAYL](#) [CXL65DBKANG](#) [BW68DBKCSBL](#) [DPH-28714-C](#) [135-007](#) [721-032](#) [1103440](#) [1037322](#) [1167159](#)
[1158978](#) [1158981](#) [1158982](#) [2202667](#) [1017444](#) [BWA-AH664](#) [100-403-91](#) [100-405-01](#) [101-003-91](#) [101-004-91](#) [101-506-01](#) [WM012I,GY](#)
[WM013I,AL](#) [WM052RI,GY](#) [WM093RI,GY](#)