

Altech Corp.®

Serving the Automation & Control Industry since 1984



**Contactors, Mini Contactors,
Overload Relays &
Manual Motor Starters**

Altech Corp.®

Since 1984, Altech Corporation has grown to become a leading supplier of automation and industrial control components. Headquartered in Flemington, NJ, Altech has an experienced staff of engineering, manufacturing and sales personnel to provide the highest quality products with superior service. This is the Altech Commitment!

With experienced Product Engineers and Customer Service personnel, Altech provides solutions to your most pressing application challenges. All with one thought in mind - *to ensure that we solve your problem the first time!*



Quality Commitment

Altech's control components meet diverse national and international standards such as UL, NEC, CSA, IEC, VDE and more. Altech provides superior customer service and delivery through Total Quality Management and Continuous Process Improvement. Altech is ISO 9001 approved. We perform these services with honesty and integrity and are committed to achieve these goals.



Table of Contents

Altech Contactor Introduction4



PC Series Introduction5

Standard PC Contactors6-13

Mini PC Contactors14-15

Full Load Amperage Table16



C Series Introduction17

Standard C Contactors18-27

Utilization Categories28-29

Quick Reference Tables30-32



MC Series Introduction33

Standard MC Contactors33-36

Reversing Contactors37-38

Accessories39

MC Series Dimensions40-43

MC Coil Specifications44

IEC Ratings45

MC Mini Contactors47-48

Manual Motor Starters49-54

Altech Contactors

Altech offers a wide variety of contactor sizes and types so that you can select the best product for your application at a price that will fit your project's budget.

PC Series Contactors



- AC-3 Ratings - 10 Amp to 115 Amp
- AC-1 Ratings - 25 Amp to 200 Amp.
- Coil Voltage - 24VAC, 24VDC, 110-120VAC, 110VDC, 200-240VAC & 230VDC
- Information starting on page 03

C Series Contactors

Designed for normal and heavy duty applications



- AC-3 Ratings - 9 Amp to 80 Amp
- AC-1 Ratings - 20 Amp to 125 Amp.
- Coil Voltage - 24VAC, 24VDC, 120VAC, 208VAC, 230VAC & 480VAC
- Information starting on page 17

MC Series Contactors

Designed for normal and heavy duty applications

- AC-3 Ratings - 9 Amp to 150 Amp
- AC-1 Ratings - 25 Amp to 210 Amp.
- Coil Voltage - 24VAC, 24VDC, 120VAC, 208VAC, 230VAC & 480VAC
- Information starting on page 34

PC Series Contactors



AC-3 = 10A - 22A
AC-1 = 25A - 30A



AC-3 = 24A - 40A
AC-1 = 50A - 80A



AC-3 = 50A - 74A
AC-1 = 110A - 130A



AC-3 = 90A - 115A
AC-1 = 160A - 200A

- Range of Products
 - 3 Pole Standard Contactors
 - 10 to 115A AC-3 Rating
 - 25 to 200A AC-1 Rating
 - 3 Pole Mini Contactor
 - 9 and 12A AC-3 Rating
 - 15 and 20A AC-1 Rating
- No derating of AC3 values for temperatures up to + 90°C
- Designed for the operation under extreme conditions including temperature, dust, sand, high humidity, shock
- Self wiping bifurcated contacts
- Minimum size & Maximum performance
- Shorter height than most competitors
- Large wire capacity
- Special contact materials provide high contact reliability
- Clip on coil surge suppression
- Side mount auxiliaries
- Optional Voltage or Current Indicators
- Quick and exact tripping in case of phase failures independent from setting ranges
- Bimetals are warmed up to achieve exact tripping

Overloads Relays

- Overload Relays from 0.1 to 630A
- From 0.12 to 120A
- 24 Setting Ranges Available
- Trip Class 10 Protection
- Manual / Automatic Reset

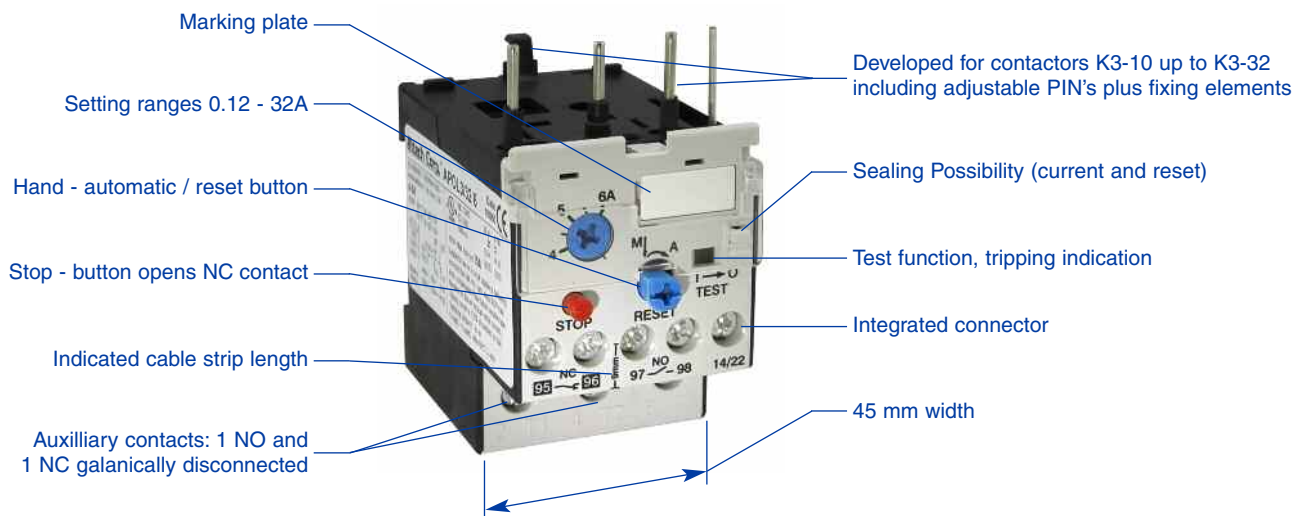

22A Frame

with built-in
auxilliary switch



AC



DC

A16PC(G)3-10ND10

A16PC(G)3-14ND10

A16PC(G)3-18ND10

A16PC(G)3-22ND10

COIL VOLTAGES*

AC Coil (60Hz)**

	Part No.	Part No.	Part No.	Part No.
24V	A16PC3-10ND10-AC24V	A16PC3-14ND10-AC24V	A16PC3-18ND10-AC24V	A16PC3-22ND10-AC24V
110-120V	A16PC3-10ND10-AC110V	A16PC3-14ND10-AC110V	A16PC3-18ND10-AC110V	A16PC3-22ND10-AC110V
200-240V	A16PC3-10ND10-AC180V	A16PC3-14ND10-AC180V	A16PC3-18ND10-AC180V	A16PC3-22ND10-AC180V

DC Coil (Standard double winding coil - regular power consumption)

	Part No.	Part No.	Part No.	Part No.
24V	A16PC3-10ND10-DC24V	A16PC3-14ND10-DC24V	A16PC3-18ND10-DC24V	A16PC3-22ND10-DC24V
110V	A16PC3-10ND10-DC110V	A16PC3-14ND10-DC110V	A16PC3-18ND10-DC110V	A16PC3-22ND10-DC110V
230V	A16PC3-10ND10-DC230V	A16PC3-14ND10-DC230V	A16PC3-18ND10-DC230V	A16PC3-22ND10-DC230V

NOTES: Parts above include 1 N.O. (10) auxiliary contact built-in. Please specify 01 in part number for N.C. auxiliary contact configuration.

CURRENT RATINGS

General Use (AC1)	25A (25A)	25A (25A)	30A (32A)	30A (32A)
Motor FLA@600V	10A	14A	18A	22A
AC3@380-400V				

HP RATINGS

	1 Phase	3 Phase	1 Phase	3 Phase	1 Phase	3 Phase	1 Phase	3 Phase
110-120V	1/2	1 1/2	3/4	2	1	2	1 1/2	3
200V	1	3	1 1/2	3	2	5	3	5
220-240V	1 1/2	3	2	3	3	7 1/2	3	7 1/2
277V	2	3	3	5	3	7 1/2	5	7 1/2
380-415V	3	5	3	5	5	10	5	10
440-480V	3	5	5	7 1/2	5	10	7 1/2	15
550-600V	3	7 1/2	5	10	7 1/2	15	10	20

PC Contactors

OVERLOAD† RELAYS



Standard
Part No.



Manual Reset
Part No.

Setting Range	Standard Part No.	Manual Reset Part No.
0.12 - 0.18	APOL3/32 0.18	APOL12/16E 0.18 C3
0.18 - 0.27	APOL3/32 0.27	APOL12/16E 0.27 C3
0.27 - 0.4	APOL3/32 0.4	APOL12/16E 0.4 C3
0.4 - 0.6	APOL3/32 0.6	APOL12/16E 0.6 C3
0.6 - 0.9	APOL3/32 0.9	APOL12/16E 0.9 C3
0.8 - 1.2	APOL3/32 1.2	APOL12/16E 1.2 C3
1.2 - 1.8	APOL3/32 1.8	APOL12/16E 1.8 C3
1.8 - 2.7	APOL3/32 2.7	APOL12/16E 2.7 C3
2.7 - 4	APOL3/32 4	APOL12/16E 4 C3
4 - 6	APOL3/32 6	APOL12/16E 6 C3
6 - 9	APOL3/32 9	APOL12/16E 9 C3
8 - 11	APOL3/32 11	APOL12/16E 11 C3
10 - 14	APOL3/32 14	APOL12/16E 14 C3
13 - 18	APOL3/32 18	APOL12/16E 18 C3
17 - 24	APOL3/32 24	APOL12/16E 23 C3
23 - 32	APOL3/32 32	APOL12/16E 30 C3

*Other coil voltages available upon request.

** (50Hz available upon request)

† Stocked parts in **BOLD**

Supressor Units

Voltage Range

12 - 48V AC-DC
48 - 127V AC-DC
110 - 230V AC/DC

Part No.

AP-RC-C3N-24
AP-RC-C3N-110
AP-RC-C3N-230

Indicators

Coil Voltage

24-120V AC/DC
Coil Current
24-660V AC/DC Green
24-660V AC/DC (Red)

Part No.

AP-C2UNR
Part No.
Green = AP-C2ING
Red = AP-C2INR

Front Mount Auxiliary

Low Level Switching

1 NO = AP-HN10 1 NC = AP-HN01

Up to 25 A Switching

1 NO = AP-HA10 1 NC = AP-HA01

Mechanical Contactor Interlock

For ND & 40A Frames

AP-LG10889

Data according to IEC 947-4-1, EN 60947-4-1, VDE 0660, UL508

Main Contacts		Type	C(G)3-10	C(G)3-14	C(G)3-18	C(G)3-22
Maximum Ambient Temperature						
Operation	open	°C	-40 to +60 (+90) ¹			
	enclosed	°C	-40 to +40			
with thermal overload relay	open	°C	-25 to +60			
	enclosed	°C	-25 to +40			
Storage		°C	-50 to +90			
Control Circuit						
Power Consumption of Coils						
AC operated	inrush	VA	33-45			
	holding	VA	7-10			
		W	2.6-3			
DC operated	inrush	W	75			
	holding	W	2			
Cable Cross-Section						
for contactors without thermal overload relay			0.75 - 6			
main connector	solid or stranded	mm ²				
			1 - 4			
			0.75 - 4			
Wire Specifications						
1 cable per terminal	main connector	solid	AWG	18 - 10 16 - 10 12 - 10		
		flexible	AWG	18 - 10 14 - 4 10 - 0		
2 cables per terminal	60°C (Cu)	solid	AWG	10+(16-10) / 12+(18-12)		
		flexible	AWG	14+(18-14) / 16+(18-16)		
60°C (Cu)		solid	AWG	10+(14-10) / 12+(18-12)		
		flexible	AWG	14+(18-14) / 16+(18-16)		
Screw / Screwdriver				M3.5 / Pz2		
Tightening Torque				0.8-1.4Nm, 7-12lb. in.		
Mechanical Life						
AC operated		S x 10 ⁶	10			
DC operated		S x 10 ⁶	10			
Short Time Current						
	10s-current	A	96	120	144	176
	120s-current	A	42	52	58	66
Power Loss per pole						
	at I _e / AC3 400V	W	0.21	0.35	0.5	0.75
	contact resistance	mOhm	2.1	1.8	1.5	1.5
Resistance to Shock acc. to IEC 68-2-27						
Shock time 20ms sine-wave	NO	g	10	10	10	10
	NC	g	6	6	6	6
Resistance to Climatic Conditions acc. to IEC60068						
Open-type devices are climate-resistant in the constant climate according to IEC60068-2-3 (this is a climate with an ambient temperature of 40°C and an atmospheric humidity of 90 to 95%).						
Enclosed devices are climate-resistant in an alternating climate according to IEC 68-2-30 (this is a moist alternating climate with a 24-hour cycle between climates with an ambient temperature of 25°C, and an atmospheric humidity of 95 to 100% and an ambient temperature of 40°C, and an atmospheric humidity of 90 to 96% in the presence of condensation during rises in temperature).						
Data are valid up to an altitude of 2000m above sea level.						
Short Circuit Current Rating						
Fuse Class RK5 / Short-circuit current		A/kA	50/5	50/5	70/5	90/5
Fuse Class T / Short-Circuit current		A/kA	45/100	50/100	70/100	90/100
Rated voltage		V	600	600	600	600

¹ With reduced control voltage range 0.9 up to 1.0 x U_s and with reduced rated current I_e / AC1 according to I_e / AC3.

Contactors

AC Operated C(G)3-10, C(G)3-14, C(G)3-18 and C(G)3-22

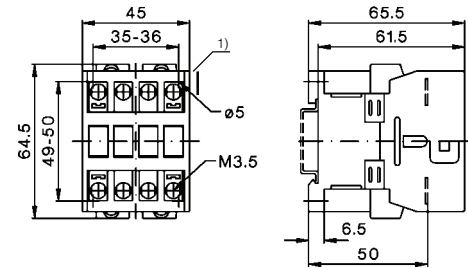

DC Operated C3-10N, C3-14N, C3-18N and C3-22N

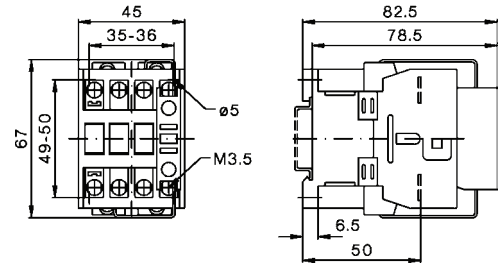

Thermal Overload Relays

C3-10N+APOL3/32, C3-18N, C3-14N and C3-22N

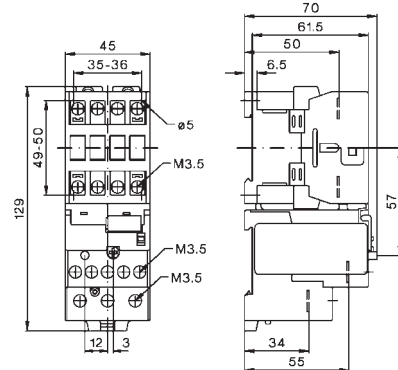

CG3-10N+APOL3/32, CG3-18N, CG3-14N and CG3-22N

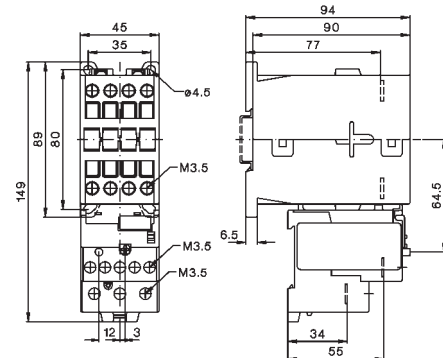

40A Frame



AC



DC

A16PC3-24A00

A16PC3-32A00

A16PC3-40A00

COIL VOLTAGES*

AC Coil (60Hz)**

	Part No.	Part No.	Part No.
24V	A16PC3-24A00-AC24V	A16PC3-32A00-AC24V	A16PC3-40A00-AC24V
110-120V	A16PC3-24A00-AC110V	A16PC3-32A00-AC110V	A16PC3-40A00-AC110V
200-240V	A16PC3-24A00-AC180V	A16PC3-32A00-AC180V	A16PC3-40A00-AC180V

DC Coil (Standard double winding coil - regular power consumption)

	Part No.	Part No.	Part No.
24V	A16PC3-24A00-DC24V	A16PC3-32A00-DC24V	A16PC3-40A00-DC24V
110V	A16PC3-24A00-DC110V	A16PC3-32A00-DC110V	A16PC3-40A00-DC110V
230V	A16PC3-24A00-DC230V	A16PC3-32A00-DC230V	A16PC3-40A00-DC230V

CURRENT RATINGS

General Use (AC1)	50A (50A)	65A (65A)	80A (80A)
Motor FLA@600V	22A	27A	34A
AC3@380-400V	24A	32A	40A

HP RATINGS

	1 Phase	3 Phase	1 Phase	3 Phase	1 Phase	3 Phase
110-120V	1 1/2	5	2	5	3	7 1/2
200V	3	7 1/2	5	10	7 1/2	10
220-240V	5	10	5	10	7 1/2	15
277V	5	7 1/2	7 1/2	10	10	15
380-415V	5	10	7 1/2	15	10	20
440-480V	7 1/2	15	10	20	15	25
550-600V	10	20	15	25	20	30

OVERLOAD† RELAYS



Standard
Part No.



Manual Reset
Part No.

Setting Range	Standard Part No.	Manual Reset Part No.
0.12 - 0.18	APOL3/32 0.18	-
0.18 - 0.27	APOL3/32 0.27	-
0.27 - 0.4	APOL3/32 0.4	-
0.4 - 0.6	APOL3/32 0.6	-
0.6 - 0.9	APOL3/32 0.9	-
0.8 - 1.2	APOL3/32 1.2	-
1.2 - 1.8	APOL3/32 1.8	-
1.8 - 2.7	APOL3/32 2.7	-
2.7 - 4	APOL3/32 4	-
4 - 6	APOL3/32 6	-
6 - 9	APOL3/32 9	-
8 - 11	APOL3/32 11	-
10 - 14	APOL3/32 14	APOL3/42 14
13 - 18	APOL3/32 18	-
14 - 20	-	APOL3/42 20
17 - 24	APOL3/32 24	-
20 - 28	-	APOL3/42 28
23 - 32	APOL3/32 32	-
28 - 42	-	APOL3/42 42

Supressor Units

Voltage Range	Part No.
12 - 48V AC-DC	AP-RC-C3N-24
48 - 127V AC-DC	AP-RC-C3N-110
110 - 230V AC/DC	AP-RC-C3N-230

Indicators

Coil Voltage	Part No.
24-120V AC/DC	AP-C2UNR
Coil Current	Part No.
24-660V AC/DC Green	Green = AP-C2ING
24-660V AC/DC (Red)	Red = AP-C2INR

Front Mount Auxiliary

Low Level Switching	
1 NO = AP-HN10	1 NC = AP-HN01

Up to 25 A Switching	
1 NO = AP-HA10	1 NC = AP-HA01

Mechanical Contactor Interlock

For ND & 40A Frames
AP-LG10889

*Other coil voltages available upon request.

** (50Hz available upon request)



† Stocked parts in **BOLD**

*Other coil voltages available upon request.

** (50Hz available upon request)

† Stocked parts in **BOLD**

Data according to IEC 947-4-1, EN 60947-4-1, VDE 0660, UL508

Main Contacts		Type	C(G)3-24	C(G)3-32	C(G)3-40
Maximum Ambient Temperature					
Operation	open	°C	-40 to +60 (+90)*		
	enclosed	°C	-40 to +40		
with thermal overload relay	open	°C	-25 to +60		
	enclosed	°C	-25 to +40		
Storage		°C	-50 to +90		
Control Circuit					
Power Consumption of Coils					
AC operated	inrush	VA	90-115		
	holding	VA	9-13		
		W	2. 7-4		
DC operated	inrush	W	140		
	holding	W	2		
Cable Cross-Section for contactors without thermal overload relay main connector					
	solid or stranded	mm ²	1.5 - 25 2.5 - 16 1.5 - 16		
Wire Specifications					
1 cable per terminal main connector	solid	AWG	6 - 10		
60°C (Cu)	flexible	AWG	14 - 4		
2 cables per terminal 60°C (Cu)	solid	AWG	10+(16-10) / 12+(18-12)		
	flexible	AWG	14+(18-14) / 16+(18-16)		
			4+(18-12) / 6+(18-8)		
			8+(18-8) / 10+(18-12)		
Screw / Screwdriver			M5 / Pz2 		
Tightening Torque			2.5-3Nm, 22-26lb. in.		
Mechanical Life					
AC operated		S x 10 ⁶	10		
DC operated		S x 10 ⁶	10		
Short Time Current					
	10s-current	A	184	240	296
	120s-current	A	80	97	110
Power Loss per pole contact resistance					
	at I _e / AC3 400V	W	0.7	1.3	2
		mOhm	1.2	1.2	1.2
Resistance to Shock acc. to IEC 68-2-27					
Shock time 20ms sine-wave	NO	g	8	8	8
	NC	g	-	-	-
Resistance to Climatic Conditions acc. to IEC60068					
Open-type devices are climate-resistant in the constant climate according to IEC60068-2-3 (this is a climate with an ambient temperature of 40°C and an atmospheric humidity of 90 to 95%).					
Enclosed devices are climate-resistant in an alternating climate according to IEC 68-2-30 (this is a moist alternating climate with a 24-hour cycle between climates with an ambient temperature of 25°C, and an atmospheric humidity of 95 to 100% and an ambient temperature of 40°C, and an atmospheric humidity of 90 to 96% in the presence of condensation during rises in temperature).					
Data are valid up to an altitude of 2000m above sea level.					
Short Circuit Current Rating					
Fuse Class RK5 / Short-circuit current		A/kA	90/5	125/5	175/5
Fuse Class T / Short-Circuit current		A/kA	110/100	150/100	150/100
Rated voltage		V	600	600	600

¹ With reduced control voltage range 0.9 up to 1.0 x U_s and with reduced rated current I_e / AC1 according to I_e / AC3.

Contactors

AC Operated C(G)3-24, C(G)3-32 and C(G)3-40

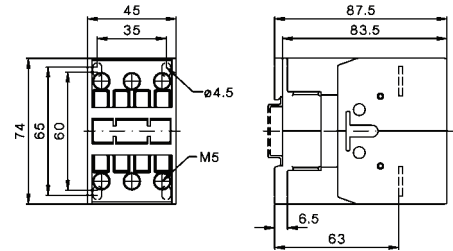

DC Operated C3-24, C3-32 and C3-40

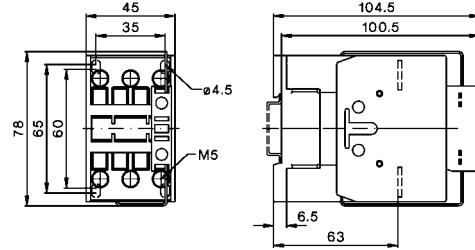

Thermal Overload Relays

C3-10N+APOL3/32, C3-18N, C3-14N and C3-22N

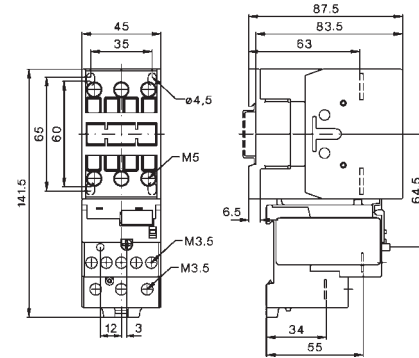

CG3-10N+APOL3/32, CG3-18N, CG3-14N and CG3-22N

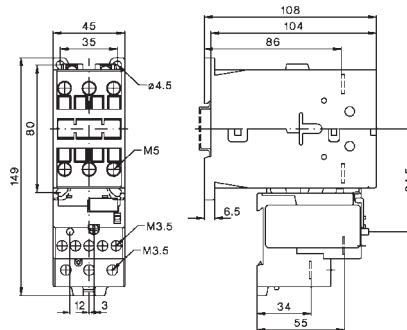

74A Frame



A16PC3-50A00

A16PC3-62A00

A16PC3-74A00

COIL VOLTAGES*

AC Coil (60Hz)**

	Part No.	Part No.	Part No.
24V	A16PC3-50A00-AC24V	A16PC3-62A00-AC24V	A16PC3-74A00-AC24V
110-120V	A16PC3-50A00-AC110V	A16PC3-62A00-AC110V	A16PC3-74A00-AC110V
200-240V	A16PC3-50A00-AC180V	A16PC3-62A00-AC180V	A16PC3-74A00-AC180V

DC Coil (Standard double winding coil - regular power consumption)

	Part No.	Part No.	Part No.
24V	A16PC3-50A00-DC24V	A16PC3-62A00-DC24V	A16PC3-74A00-DC24V
110V	A16PC3-50A00-DC110V	A16PC3-62A00-DC110V	A16PC3-74A00-DC110V
230V	A16PC3-50A00-DC230V	A16PC3-62A00-DC230V	A16PC3-74A00-DC230V

CURRENT RATINGS

General Use (AC1)	110A (110A)	120A (120A)	130A (130A)
Motor FLA@600V	44A	52A	66A
AC3@380-400V	50A	62A	74A

HP RATINGS

	1 Phase	3 Phase	1 Phase	3 Phase	1 Phase	3 Phase
110-120V	3	10	5	10	7 1/2	10
200V	7 1/2	15	10	20	15	25
220-240V	10	20	15	25	15	30
277V	10	20	15	25	15	30
380-415V	15	25	20	30	20	40
440-480V	20	30	25	40	25	50
550-600V	25	40	30	50	30	50

OVERLOAD† RELAYS

Setting Range	Standard Part No.
20 - 28	APOL3/74 28
28 - 42	APOL3/74 42
40 - 52	APOL3/74 52
52 - 65	APOL3/74 65
60 - 74	APOL3/74 74

Suppressor Units



Voltage Range	Part No.
12 - 48V AC-DC	AP-RC-C3N-24
48 - 127V AC-DC	AP-RC-C3N-110
110 - 230V AC/DC	AP-RC-C3N-230

Indicators



Coil Voltage	Part No.
24-120V AC/DC	AP-C2UNR
Coil Current	Part No.
24-660V AC/DC Green	Green = AP-C2ING
24-660V AC/DC (Red)	Red = AP-C2INR

Front Mount Auxiliary



Low Level Switching	
1 NO = AP-HN10	1 NC = AP-HN01



Up to 25 A Switching	
1 NO = AP-HA10	1 NC = AP-HA01





Mechanical Contactor Interlock
For ND & 40A Frames
AP-LG10889

*Other coil voltages available upon request.

** (50Hz available upon request)

† Stocked parts in **BOLD**

Data according to IEC 947-4-1, EN 60947-4-1, VDE 0660, UL508

Main Contacts		Type	C(G)3-24	C(G)3-32	C(G)3-40
Maximum Ambient Temperature					
Operation	open	°C	-40 to +60 (+90) ¹		
	enclosed	°C	-40 to +40		
with thermal overload relay	open	°C	-25 to +60		
	enclosed	°C	-25 to +40		
Storage		°C	-50 to +90		
Control Circuit					
Power Consumption of Coils					
AC operated	inrush	VA	140-165		
	holding	VA	13-18		
DC operated	inrush	W	5. 4-7		
	holding	W	200		
double winding coil		W	6		
Cable Cross-Section					
for contactors without thermal overload relay					
main connector	solid or stranded	mm ²		4 - 50	
				10 - 35	
				6 - 35	
Wire Specifications					
1 cable per terminal main connector	solid	AWG	12 - 10		
	flexible	AWG	10 - 10		
2 cables per terminal 75°C (Cu)	solid	AWG	10+(12-10) / 12+12		
	flexible	AWG	1+(12-10) / 2+(8-12) 3+(12-8) / 4+(10-6)		
Screw / Screwdriver			M6 / Pz3 		
Tightening Torque			3.5-4.5Nm, 31-40lb. in.		
Mechanical Life					
AC operated		S x 10 ⁶		10	
DC operated		S x 10 ⁶		10	
Short Time Current					
10s-current		A	450	504	592
	120s-current	A	195	203	222
Power Loss per pole contact resistance					
at I _e / AC3 400V		W	2.2	3.9	5.5
		mOhm	1	1	1
Resistance to Shock acc. to IEC 68-2-27					
Shock time 20ms sine-wave	NO	g	8	8	8
	NC	g	-	-	-
Resistance to Climatic Conditions acc. to IEC60068					
Open-type devices are climate-resistant in the constant climate according to IEC60068-2-3 (this is a climate with an ambient temperature of 40°C and an atmospheric humidity of 90 to 95%). Enclosed devices are climate-resistant in an alternating climate according to IEC 68-2-30 (this is a moist alternating climate with a 24-hour cycle between climates with an ambient temperature of 25°C, and an atmospheric humidity of 95 to 100% and an ambient temperature of 40°C, and an atmospheric humidity of 90 to 96% in the presence of condensation during rises in temperature). Data are valid up to an altitude of 2000m above sea level.					
Short Circuit Current Rating					
Fuse Class RK5 / Short-circuit current		A/kA	200/5	250/5	300/5
Fuse Class T / Short-Circuit current		A/kA	175/100	175/100	175/100
Rated voltage		V	600	600	600

¹ With reduced control voltage range 0.9 up to 1.0 x U_s and with reduced rated current I_e / AC1 according to I_e / AC3.

Contactors

AC Operated C3-50, C3-62 and C3-74

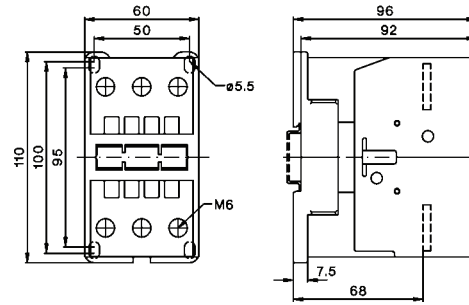

DC Operated C3-50, C3-62 and C3-74

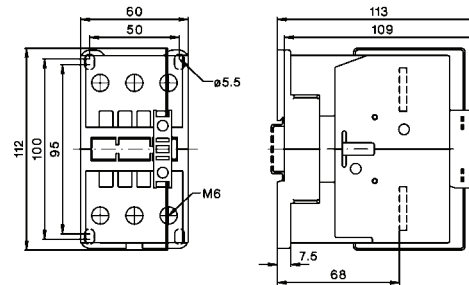

Thermal Overload Relays

C3-50+APOL3/74, C3-62+APOL3/74 and C3-74+APOL3/74

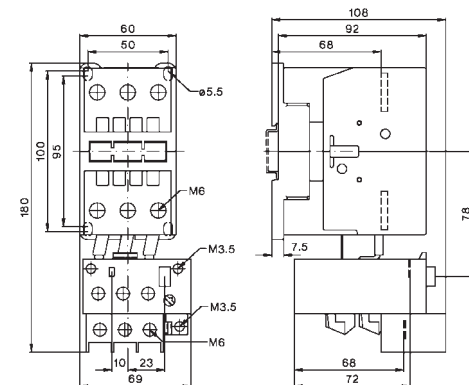

115A Frame

with built-in
auxilliary switch



A16PC3-90A00

A16PC3-115A00

COIL VOLTAGES*

AC Coil (50/60Hz)** /DC Coil

	Part No.	Part No.
24V AC / 24V DC	A16PC3-90A00-24V	A16PC3-115A00-24V
110-120V AC / 110V DC	A16PC3-90A00-110V	A16PC3-115A00-110V
200-240V AC / 220V DC	A16PC3-90A00-230V	A16PC3-115A00-230V

CURRENT RATINGS

	160A (160A)	200A (200A)
General Use (AC1)		
Motor FLA@600V	85A	99A
AC3@380-400V	90A	115A

HP RATINGS

	1 Phase	3 Phase	1 Phase	3 Phase
110-120V	8	15	10	20
200V	15	25	20	35
220-240V	20	35	25	40
277	20	-	25	-
380-415V	30	50	40	60
440-480V	40	65	50	75
550-600V	50	85	60	100

OVERLOAD+ RELAYS

Setting Range	Standard Part No.
60 - 90	APOL85/90
80 - 120	APOL85/120

*Other coil voltages available upon request.

** (50Hz available upon request)

† Stocked parts in **BOLD**

Data according to IEC 947-4-1, EN 60947-4-1, VDE 0660, UL508

Main Contacts	Type		C3-90	C3-115
Maximum Ambient Temperature Operation	open	°C	-40 to +60 (+90) ¹	
	enclosed	°C	-40 to +40	
	with thermal overload relay	°C	-25 to +60	
	enclosed	°C	-25 to +40	
	Storage	°C	-50 to +90	
Control Circuit				
Power Consumption of Coils				
AC operated	inrush	VA	165-220	
	holding	VA	2.5-5	
DC operated	inrush	W	2.5-5	
	double winding coil	holding	W	5
Cable Cross-Section for contactors without thermal overload relay main connector			solid or stranded	mm ²
			 0.5 - 95 10 - 120	
Wire Specifications				
1 cable per terminal				
main connector	solid	AWG	18 - 10	—
	flexible	AWG	18 - 3/0	8-4/0
2 cables per terminal	solid	AWG	—	
	flexible	AWG	18-3/0+8-4/0	
Screw / Screwdriver			M8 / 4mm Hex	
Tightening Torque			4-6.5Nm, 35-57lb. in.	
Mechanical Life				
AC operated		S x 10 ⁶	10	
DC operated		S x 10 ⁶	10	
Short Time Current				
10s-current		A	680	880
	120s-current	A	275	330
Power Loss per pole				
contact resistance	at I _e / AC3 400V	W	4.8	7.9
		mOhm	0.6	0.5
Resistance to Shock acc. to IEC 68-2-27				
Shock time 20ms sine-wave	NO	g	7	7
	NC	g	5	5
Resistance to Climatic Conditions acc. to IEC60068				
Open-type devices are climate-resistant in the constant climate according to IEC60068-2-3 (this is a climate with an ambient temperature of 40°C and an atmospheric humidity of 90 to 95%).				
Enclosed devices are climate-resistant in an alternating climate according to IEC 68-2-30 (this is a moist alternating climate with a 24-hour cycle between climates with an ambient temperature of 25°C, and an atmospheric humidity of 95 to 100% and an ambient temperature of 40°C, and an atmospheric humidity of 90 to 96% in the presence of condensation during rises in temperature).				
Data are valid up to an altitude of 2000m above sea level.				
Short Circuit Current Rating				
Fuse Class RK5 / Short-circuit current		A/kA	300/10	300/10
Fuse Class T / Short-Circuit current		A/kA	300/100 ²	300/100 ²
Rated voltage		V	600	600

¹ With reduced control voltage range 0.9 up to 1.0 x U_s and with reduced rated current I_e / AC1 according to I_e / AC3.

² Class T and Class RK1

Contactors

AC and DC Operated C3-90 and C3-115

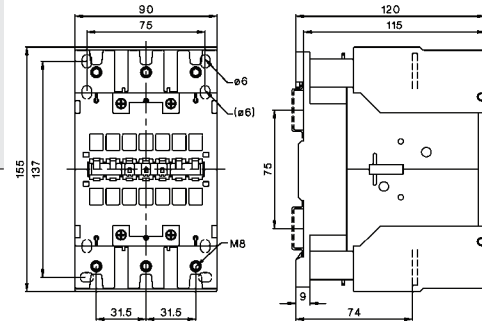

Thermal Overload Relays

C3-90A+APOL and C3-115A+APOL

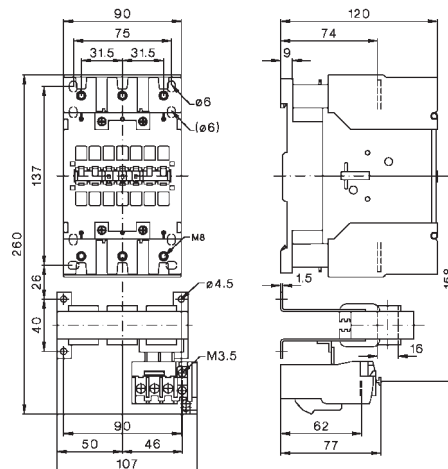

MINI Frame

with built-in
auxilliary switch



AC



DC

A16PC1-09D10

A16PC1-12D10

COIL VOLTAGES*

AC Coil (60Hz)**

	Part No.	Part No.
24V	A16PC1-09D10-AC24V	A16PC1-12D10-AC24V
120-125V	A16PC1-09D10-AC110V	A16PC1-12D10-AC110V

DC Coil (Solenoid operated coil - low power consumption)

24V	A16PC1-09D10-DC24V	A16PC1-12D10-DC24V
-----	--------------------	--------------------

NOTES: Parts above include 1 N.O. (10) auxiliary contact built-in. Please specify 01 in part number for N.C. auxiliary contact configuration.

CURRENT RATINGS

General Use (AC1)	15A (20A)	20A (20A)
Motor FLA@600V	9A	12A
AC3@380-400V		

HP RATINGS

	1 Phase	3 Phase	1 Phase	3 Phase
110-120V	1/2	1 1/2	3/4	2
200V	1	3	1 1/2	3
220-240V	1 1/2	3	2	3
440-480V	-	5	-	7 1/2
550-600V	-	7 1/2	-	10



Manual Reset
Part No.

Setting Range	Part No.
0.12 - 0.18	APOL12/16E 0.18 C1
0.18 - 0.27	APOL12/16E 0.27 C1
0.27 - 0.4	APOL12/16E 0.4 C1
0.4 - 0.6	APOL12/16E 0.6 C1
0.6 - 0.9	APOL12/16E 0.9 C1
0.8 - 1.2	APOL12/16E 1.2 C1
1.2 - 1.8	APOL12/16E 1.8 C1
1.8 - 2.7	APOL12/16E 2.7 C1
2.7 - 4	APOL12/16E 4 C1
4 - 6	APOL12/16E 6 C1
6 - 9	APOL12/16E 9 C1
8 - 11	APOL12/16E 11 C1
10 - 14	APOL12/16E 14 C1

*Other coil voltages available upon request.

** (50Hz available upon request)

† Stocked parts in **BOLD**

Suppressor Units



Voltage Range		Part No.
12 - 48V AC/DC	160nF / 22 Ohm	AP-RC-C1 24
48 - 127V AC/DC	6800nF / 270 Ohm	AP-RC-C1 110
110 - 250V AC/DC	220nF / 2200 Ohm	AP-RC-C1 230

DIMENSIONS

AC and DC operated with screw terminals C1-09D... , C1-12D...

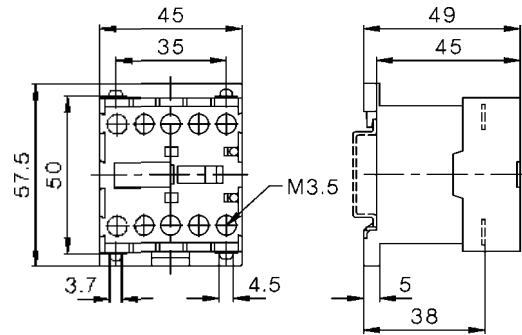

Auxiliary Contact Blocks for Contactor Relays



Ratings AC15	Thermal Rated Current	Contacts	Part No.
A	A	NO NC	
3	2	10 1 1	HCM11
3	2	10 - 2	HCM02
3	2	10 2 -	HCM20
3	2	10 1 3	HCM13
3	2	10 4 -	HCM40
3	2	10 2 2	HCM22
3	2	10 - 4	HCM04
3	2	10 3 1	HCM31

MINI Frame - Specifications and Dimensions

Data according to IEC 947-4-1, EN 60947-4-1, VDE 0660, UL508

Main Contacts	Type		A16PC1-09D10	A16pc1-12D10
Maximum Ambient Temperature				
Operation open	open	°C	-40 to +60 (+90)*	
	enclosed	°C	-40 to +40	
with thermal overload relay	open	°C	-25 to +60	
enclosed		°C	-25 to +40	
Storage		°C	-50 to +90	

*with reduced control voltage range 0.9 up to 1.0 U and with reduced rated current I/AC1 according to Ie/AC3

Control Circuit Power Consumption of Coils				
AC operated	inrush	VA	25	
	sealed	VA	4 - 5	
		W	1.2	
DC operated	inrush	W	2.5	
	sealed	W	2.5	

Cable Cross Section				
for contactors without overloads				
Solid or stranded wire				
		AWG	20 - 14	
		mm ²	0.5 - 2.5	
Cables per clamp			2	

Mechanical Life				
AC operated		S x 10	5	
DC operated		S x 10	10	

Short Circuit Time				
		10s-current A	96	120
Power loss per pole		at Ie/AC3 400V W	0.15	0.25

Resistance to Shock acc. To IEC 68-2-27				
AC operated		NO g	5	
		NC g	5	
	DC operated		NO g	8
		NC g	6	

Resistance to Climatic Conditions acc. to IEC60068

Open-type devices are climate-resistant in the constant climate according to IEC60068-2-3 (this is a climate with an ambient temperature of 40°C and an atmospheric humidity of 90 to 95%). Enclosed devices are climate-resistant in an alternating climate according to IEC 68-2-30 (this is a moist alternating climate with a 24-hour cycle between climates with an ambient temperature of 25°C, and an atmospheric humidity of 95 to 100% and an ambient temperature of 40°C, and an atmospheric humidity of 90 to 96% in the presence of condensation during rises in temperature). Data are valid up to an altitude of 2000m above sea level.

Short Circuit Current Rating				
Fuse / Short-circuit current		A/Ka	30/5	

Rated Voltage		V AC	600	
----------------------	--	------	-----	--

Definitions

Motor Full Load Amperage Table

Phasing Voltage Horse Power	Single phase			Three phase				
	110 -120V Amperage	208V Amperage	220 - 240V Amperage	110 -120V Amperage	208V Amperage	220 - 240V Amperage	440 - 480V Amperage	550 - 600V Amperage
1/10	3.0	-	1.5	3.0	-	-	-	-
1/8	3.8	-	1.9	3.8	-	-	-	-
1/6	4.0	2.4	2.2	4.4	-	-	-	-
1/4	5.8	3.2	2.9	5.8	-	-	-	-
1/3	7.2	4.0	3.6	7.2	-	-	-	-
1/2	9.8	5.4	4.9	9.8	2.4	2.2	1.1	0.9
3/4	13.8	7.6	6.9	13.8	3.5	3.2	1.6	1.3
1	16.0	8.8	8.0	16.0	4.6	4.2	2.1	1.7
1 1/2	20.0	11.0	10.0	20.0	6.6	6.0	3.0	2.4
2	24.0	13.2	12.0	24.0	7.5	6.8	3.4	2.7
3	34.0	18.7	17.0	34.0	10.6	9.6	4.8	3.9
5	56.0	30.8	28.0	56.0	16.7	15.2	7.6	6.1
7 1/2	80.0	44.0	40.0	80.0	24.2	22.0	11.0	9.0
10	100.0	55.0	50.0	100.0	30.8	28.0	14.0	11.0
15	135.0	-	68.0	135.0	46.2	42.0	21.0	17.0
20	-	-	88.0	-	59.4	54.0	27.0	22.0
25	-	-	110.0	-	74.8	68.0	34.0	27.0
30	-	-	136.0	-	88.0	80.0	40.0	32.0
40	-	-	176.0	-	114.0	104.0	52.0	41.0
50	-	-	216.0	-	143.0	130.0	65.0	52.0
60	-	-	-	-	169.0	154.0	77.0	62.0
75	-	-	-	-	211.0	192.0	96.0	77.0
100	-	-	-	-	273.0	248.0	124.0	99.0
125	-	-	-	-	343.0	312.0	156.0	125.0
150	-	-	-	-	396.0	360.0	180.0	144.0
200	-	-	-	-	528.0	480.0	240.0	192.0
250	-	-	-	-	-	604.0	302.0	242.0
300	-	-	-	-	-	722.0	361.0	289.0
350	-	-	-	-	-	828.0	414.0	336.0
400	-	-	-	-	-	951.0	477.0	382.0
450	-	-	-	-	-	1030.0	515.0	412.0
500	-	-	-	-	-	1180.0	590.0	472.0

For reference purpose only. Motor characteristics may vary. Consult the motor's information plate for exact values.

C Series Contactors

Low Power Consumption Coils

- Energy Saving
- Down Sizing of Control Transformer

Safety First

- Finger Safe IEC rated IP 20 Terminals
- Power & Control Terminals Touch-Safe

Compact Modular Design

- Design Flexibility
- Space Saving

Installation Made Easy

- DIN Rail Mounting or Screw Mount
- Assembly Time & Labour Saving



Auxiliary Contact In-built

- Stocking & Specifying Made Easy

Protective Security Cover

- Prevents Accidental Manual Operation
- Prevents Dust Entry

- Complete Range of Products
 - 3 Pole Contactors
 - 9 to 80A AC-3 Rating
 - 20 to 125A AC-1 Rating
 - 4 Pole Contactors
 - 9 to 80A AC-3 Rating
 - 20 to 125A AC-1 Rating
 - 4NO or 2NO/2NC Contacts
 - 4 Pole Control Relays
 - 10A @ 240V AC-15 Rating
 - 4NO, 3NO/1NC or 2NO/2NC Contacts
- Energy Saving Magnetic Coils in both AC and DC
- Overload Relays from 1.6 to 50A
 - Trip Class 10 Protection
 - Manual / Automatic Reset
- Compact Modular Design
- Finger Touch Protected Power & Control Terminals
- Large Temperature Range
- High Mechanical & Electrical Life

18A Frame

3 Pole Contactors

- 9A to 18A (AC3)



With AC Coil



With DC Coil

A16C-0910

A16C-1210

A16C-1810

COIL VOLTAGES*

3 Pole with One NO Built in Auxiliary

Coil Voltage	Coil Hertz	Part No.	Part No.	Part No.
24VAC	50/60 Hz	A16C-0910-B7	A16C-1210-B7	A16C-1810-B7
24VDC	-	-	A16DC-1210-BD	A16DC-1810-BD
120VAC	50/60 Hz	A16C-0910-G7	A16C-1210-G7	A16C-1810-G7
208VAC	60 Hz *	A16C-0910-L6	-	-
230VAC	50/60 Hz	A16C-0910-P7	A16C-1210-P7	-
480VAC	60 Hz *	A16C-0910-T6	-	A16C-1810-T6

* 50 Hz versions available upon request

CURRENT RATINGS

Maximum Current

	A16C-0910	A16C-1210	A16C-1810
AC-3 Inductive	9 A	12 A	18 A
AC-1 Continuous	20 A	25 A	32 A

HP RATINGS

Maximum HP Single Phase

	A16C-0910	A16C-1210	A16C-1810
120V	0.5 HP	1 HP	1 HP
230V	1 HP	2 HP	3 HP

Maximum HP Three Phase

	A16C-0910	A16C-1210	A16C-1810
200V	2 HP	3 HP	5 HP
230V	2 HP	3 HP	5 HP
480V	5 HP	7.5 HP	10 HP
600V	7.5 HP	10 HP	15 HP

OVERLOAD⁺ RELAYS



Setting Range (A)	Part No.
1.6-2.5	A16CR09-2.5A
2.5-4	A16CR09-4A
4-6	A16CR09-6A
5.5-8	A16CR09-8A
7-10	A16CR09-10A
9-13	A16CR12-13A
12-18	A16CR18-18A
17-25	A16CR25-25A

C Contactors

18A Frame Specifications and Dimensions

3 Pole Contactors - 9A to 18A (AC3)

General Technical Information

Rated insulation voltage (Ui)	1000V (according to IEC60947-4-1)
Conforming to standards	NFC EN60947, VDE0660, BSEN60947, IEC60947 & IS13947
Approvals	UL
Protection (Conforming to VDE0106)	Protection against direct finger contact
Temperature rating - Storage	-60°C to +80°C
- Operation	-5°C to +55°C (0.8 to 1.1Uc)
- Permissible	-60°C to +80°C for operation at Uc
Maximum operating altitude	3000 Meters (without derating)

Pole Characteristics

AC-3 Inductive Rating	9	12	18
Type (with 1NC Aux.)	A16C-0910	A16C-1210	A16C01810
Type (with 1NO Aux.)	A16C-0901	A16C-1201	A16C01801
Number of poles (Power)	3	3	3
Power + Auxiliary	3+1	3+1	3+1
Max. Power Contact Wire (mm ² /AWG)	4 / 12	4 / 12	6 / 10
Rated current (AC3 up to 440V @55°C)	9 A	12 A	18 A
Rated operating voltage (up to)	690 V	690 V	690 V
Frequency (of operational current)	25-400 Hz	25-400 Hz	25-400 Hz
Rated Thermal Current (Ith)<40°C	25 A	25 A	32 A
Rated making/breaking capacity			
Make - I rms conforming to IEC-60947-4	250 A	250 A	300A
Break - I rms conforming to 223-440V	250 A	250 A	300A
Break - IEC-60947-4 500V	175 A	175 A	250 A
Break- IEC-60947-4 660-690V	85 A	85 A	120 A
Average impedance per pole (Max. At Ith and 50Hz Milli)	2.5 Max.	2.5 Max.	2.5 Max.
Power dissipation (per pole for the AC-3 above operational currents)	0.2 W	0.36 W	0.8 W

Control Circuit Characteristics

AC Coil		12 - 660 V	12 - 660 V	12 - 660 V
Rated control circuit volts. (Uc)		12 - 660 V	12 - 660 V	12 - 660 V
Control voltage limits (0 < 55° C)		0.8 - 1.1 Uc	0.8 - 1.1 Uc	0.8 - 1.1 Uc
Operational (50 or 60Hz Coil)				
Drop out (50 or 60Hz Coil)		0.3 - 0.6 Uc	0.3 - 0.6 Uc	0.3 - 0.6 Uc
Operational(50/60Hz Coil)		0.85 - 1.1 Uc	0.85 - 1.1 Uc	0.85 - 1.1 Uc
Average consumption at 20°C and at Uc at AC 60 Hz	Inrush	60 Hz Coil	70 VA	70 VA
	Sealed	50/60 Hz Coil	70 VA	70 VA
		COS O	0.75	0.75
	60 Hz Coil	60 Hz Coil	7.5 VA	7.5 VA
		COS O	0.3	0.3
	Average operating time at Uc	Closing time	12-22 msec	12-22 msec
Opening time		04-12 msec	04-12 msec	
Mechanical Life Cycles (durability)		15 x 10 ⁷	15 x 10 ⁷	
Maximum Operating Rate cycles/hr		3,600	3,600	
Rated control circuit volts. (Uc)		12 - 660 V	12 - 660 V	
Control voltage limits (0 < 55° C)		0.8 - 1.1 Uc	0.8 - 1.1 Uc	
Operational Standard Coil				
Average consumption DC at 20°C and at Uc	Drop Out	0.1 - 0.25 Uc	0.1 - 0.25 Uc	
	DC Inrush	9 W	9 W	
	DC Sealed	9 W	9 W	
Average operating time at Uc	Closing time	40-48 msec	40-48 msec	
	Opening time	6-14 msec	6-14 msec	
Mechanical Life Cycles (durability)		30 x 10 ⁷	30 x 10 ⁷	
Maximum Operating Rate cycles/hr		3,600	3,600	

Integral Auxiliary Characteristics

Rated Thermal Current (Ith)<40°C	10 A	10 A	10 A
Rated operating voltage (up to)	660 V	660 V	660 V

Dimensions (AC Coil)

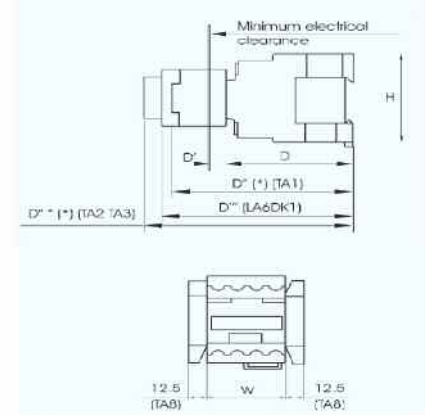

Type	A16C-0910	A16C-1210	A16C-1810
W	45	45	45
H	74	74	74
D	80	80	85
D'	10	10	10
D''	113	113	113
D'''	120	120	120
D''''	133	133	138

Dimensions (DC Coil)

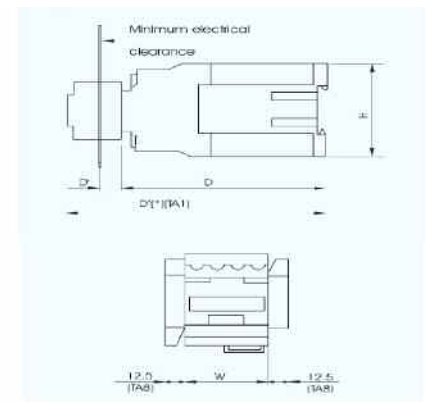

Type	A16C-0910	A16C-1210	A16C-1810
W	45	45	45
H	74	74	74
D	115	115	115
D'	10	10	10
D''	148	148	153

32A Frame 3 Pole Contactors - 25A to 32A (AC3)



With AC Coil



With DC Coil

A16C-2510

A16C-3210

COIL VOLTAGES*

3 Pole with One NO Built in Auxiliary

Coil Voltage	Coil Hertz	Part No.	Part No.
24VAC	50/60 Hz	A16C-2510-B7	A16C-3210-B7
24VDC	-	A16DC-2510-BD	A16DC-3210-BD
120VAC	50/60 Hz	A16C-2510-G7	A16C-3210-G7
208VAC	60 Hz *	A16C-2510-L6	A16C-3210-L6
230VAC	50/60 Hz	A16C-2510-P7	A16C-3210-P7
480VAC	60 Hz *	-	A16C-3210-T6

* 50 Hz versions available upon request

CURRENT RATINGS

Maximum Current

AC-3 Inductive	25 A	32 A
AC-1 Continuous	40 A	50 A

HP RATINGS

Maximum HP Single Phase

120V	2 HP	2 HP
230V	3 HP	5 HP

Maximum HP Three Phase

200V	5 HP	10 HP
230V	7.5 HP	10 HP
480V	15 HP	20 HP
600V	20 HP	25 HP

OVERLOAD+ RELAYS



Setting Range (A)	Part No.
23-32	A16CR32-32A
28-36	A16CR32-36A

32A Frame Specifications and Dimensions

3 Pole Contactors - 25A to 32A (AC3)

General Technical Information

Rated insulation voltage (Ui)	1000V (according to IEC60947-4-1)
Conforming to standards	NFC EN60947, VDE0660, BSEN60947, IEC60947 & IS13947
Approvals	UL
Protection (Conforming to VDE0106)	Protection against direct finger contact
Temperature rating - Storage	-60°C to +80°C
- Operation	-5°C to +55°C (0.8 to 1.1Uc)
- Permissible	-60°C to +80°C for operation at Uc
Maximum operating altitude	3000 Meters (without derating)

Pole Characteristics

	25	32
AC-3 Inductive Rating		
Type (with 1NC Aux.)	A16C-2510	A16C-3210
Type (with 1NO Aux.)	A16C-2501	A16C-3201
Number of poles (Power)	3	3
Power + Auxiliary	3+1	3+1
Max. Power Contact Wire (mm ² /AWG)	10 / 8	10 / 8
Rated current (AC3 up to 440V @55°C)	25 A	32 A
Rated operating voltage (up to)	690 V	690 V
Frequency (of operational current)	25-400 Hz	25-400 Hz
Rated Thermal Current (Ith)<40°C	45 A	50 A
Rated making/breaking capacity		
Make - Irms conforming to IEC-60947-4	450 A	550 A
Break - Irms conforming to 223-440V	450 A	550 A
Break - IEC-60947-4 500V	400 A	450 A
Break - IEC-60947-4 660-690V	180 A	180 A
Average impedance per pole (Max. At Ith and 50Hz Milli)	2 Max.	2 Max.
Power dissipation (per pole for the above operational currents) AC-3	1.25 W	2 W

Control Circuit Characteristics

		12 - 660 V	12 - 660 V
Rated control circuit volts. (Uc)		12 - 660 V	12 - 660 V
Control voltage limits (0 < 55° C)		0.8 - 1.1 Uc	0.8 - 1.1 Uc
Operational (50 or 60Hz Coil)			
Drop out (50 or 60Hz Coil)		0.3 - 0.6 Uc	0.3 - 0.6 Uc
Operational(50/60Hz Coil)		0.85 - 1.1 Uc	0.85 - 1.1 Uc
AC Coil	Inrush	60 Hz Coil	100 VA
	Average consumption	50/60 Hz Coil	100 VA
		COS O	0.75
	at 20°C and at Sealed	60 Hz Coil	8.5 VA
		Uc at AC 60 Hz	50/60 Hz Coil
		COS O	0.3
Average operating time at Uc	Closing time	15-24 msec	15-24 msec
	Opening time	05-19 msec	05-19 msec
Mechanical Life Cycles (durability)		12 x 10 ⁷	12 x 10 ⁷
Maximum Operating Rate cycles/hr		3,600	3,600
Rated control circuit volts. (Uc)		12 - 660 V	12 - 660 V
Control voltage limits (0 < 55° C)		0.8 - 1.1 Uc	0.8 - 1.1 Uc
Operational Standard Coil			
DC Coil	Average consumption DC	Drop Out	0.1 - 0.25 Uc
	at 20°C and at Uc	DC Inrush	11 W
		DC Sealed	11 W
	Average operating time at Uc	Closing time	52-64 msec
Opening time		8-14 msec	8-14 msec
Mechanical Life Cycles (durability)		25 x 10 ⁷	25 x 10 ⁷
Maximum Operating Rate cycles/hr		3,600	3,600

Integral Auxiliary Characteristics

Rated Thermal Current (Ith)<40°C	10 A	10 A
Rated operating voltage (up to)	660 V	660 V

Dimensions (AC Coil)

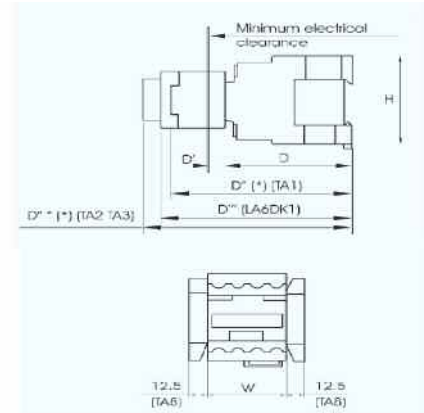

Type	A16C-2510	A16C-3210
W	56	56
H	84	84
D	94	99
D'	10	10
D''	126	131
D'''	135	140
D''''	147	152

Dimensions (DC Coil)

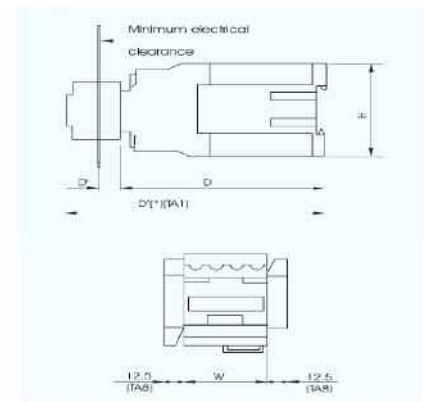

Type	A16C-0910	A16C-1210
W	56	56
H	84	84
D	130	135
D'	10	10
D''	163	168

65A Frame
3 Pole Contactors
 - 40A to 65A (AC3)



With AC Coil



With DC Coil

A16C-4011

A16C-5011

A16C-6511

COIL VOLTAGES*

3 Pole with One NO and One NC Built in Auxiliary

Coil Voltage	Coil Hertz	Part No.	Part No.	Part No.
24VAC	50/60 Hz	A16C-4011-B7	-	-
24VDC	-	A16DC-4011-BD	-	-
120VAC	50/60 Hz	A16C-4011-G7	A16C-5011-G7	A16C-6511-G7
208VAC	60 Hz *	A16C-4011-L6	-	-
230VAC	50/60 Hz	-	A16C-5011-P7	A16C-6511-P7

* 50 Hz versions available upon request

CURRENT RATINGS

Maximum Current

	40 A	50 A	65 A
AC-3 Inductive			
AC-1 Continuous	60 A	80 A	80 A

HP RATINGS

Maximum HP Single Phase

	3 HP	3 HP	5 HP
120V			
230V	5 HP	7.5 HP	10 HP

Maximum HP Three Phase

	10 HP	15 HP	20 HP
200V			
230V	10 HP	15 HP	20 HP
480V	30 HP	40 HP	50 HP
600V	30 HP	40 HP	50 HP

OVERLOAD+ RELAYS



Setting Range (A)	Part No.
30-40	A16CR40-40A
37-50	A16CR65-50A

65A Frame Specifications and Dimensions

3 Pole Contactors - 40A to 65A (AC3)

General Technical Information

Rated insulation voltage (Ui)	1000V (according to IEC60947-4-1)
Conforming to standards	NFC EN60947, VDE0660, BSEN60947, IEC60947 & IS13947
Approvals	UL
Protection (Conforming to VDE0106)	Protection against direct finger contact
Temperature rating - Storage	-60°C to +80°C
- Operation	-5°C to +55°C (0.8 to 1.1Uc)
- Permissible	-60°C to +80°C for operation at Uc
Maximum operating altitude	3000 Meters (without derating)

Pole Characteristics

AC-3 Inductive Rating	40	50	65
Type (with 1NO & 1NC Aux.)	A16C-4011	A16C-5011	A16C-6511
Number of poles (Power)	3	3	3
Power + Auxiliary	3+2	3+2	3+2
Max. Power Contact Wire (mm ² /AWG)	25 / 4	25 / 4	25 / 4
Rated current (AC3 up to 440V @55°C)	40 A	50 A	65 A
Rated operating voltage (up to)	690 V	690 V	690 V
Frequency (of operational current)	25-400 Hz	25-400 Hz	25-400 Hz
Rated Thermal Current (Ith)<40°C	60 A	80 A	80 A
Rated making/break capacity			
Make - Irms conforming to IEC-60947-4	800 A	900 A	1,000 A
Break - Irms conforming to 223-440V	800 A	900 A	1,000 A
Break - IEC-60947-4 500V	800 A	900 A	1,000 A
Break - IEC-60947-4 660-690V	400 A	500 A	630 A
Average impedance per pole (Max. At Ith and 50Hz Milli)	1.5 Max.	1.5 Max.	1 Max.
Power dissipation (per pole for the above operational currents) AC-3	2.4 W	3.7 W	4.2 W

Control Circuit Characteristics

AC Coil		12 - 660 V	12 - 660 V	12 - 660 V
Rated control circuit volts. (Uc)		12 - 660 V	12 - 660 V	12 - 660 V
Control voltage limits (0 < 55° C)		0.8 - 1.1 Uc	0.8 - 1.1 Uc	0.8 - 1.1 Uc
Operational (50 or 60Hz Coil)				
Drop out (50 or 60Hz Coil)		0.3 - 0.6 Uc	0.3 - 0.6 Uc	0.3 - 0.6 Uc
Operational(50/60Hz Coil)		0.85 - 1.1 Uc	0.85 - 1.1 Uc	0.85 - 1.1 Uc
Average consumption at 20°C and at Uc at AC 60 Hz	Inrush	60 Hz Coil	220 VA	220 VA
	Sealed	50/60 Hz Coil	245 VA	245 VA
		COS O	0.75	0.75
	60 Hz Coil	60 Hz Coil	22 VA	22 VA
		COS O	0.3	0.3
Average operating time at Uc		Closing time	20-26 msec	20-26 msec
		Opening time	08-12 msec	08-12 msec
Mechanical Life Cycles (durability)		6 x 10 ⁷	6 x 10 ⁷	6 x 10 ⁷
Maximum Operating Rate cycles/hr		3,600	3,600	3,600
Rated control circuit volts. (Uc)		12 - 660 V	12 - 660 V	12 - 660 V
Control voltage limits (0 < 55° C)		0.8 - 1.1 Uc	0.8 - 1.1 Uc	0.8 - 1.1 Uc
Operational Standard Coil				
Average consumption DC at 20°C and at Uc	Drop Out	0.1 - 0.3 Uc	0.1 - 0.3 Uc	0.1 - 0.3 Uc
	DC Inrush	22 W	22 W	22 W
	DC Sealed	22 W	22 W	22 W
Average operating time at Uc	Closing time	85-110 msec	85-110 msec	85-110 msec
	Opening time	20-35 msec	20-35 msec	20-35 msec
Mechanical Life Cycles (durability)		20 x 10 ⁷	20 x 10 ⁷	20 x 10 ⁷
Maximum Operating Rate cycles/hr		3,600	3,600	3,600

Integral Auxiliary Characteristics

Rated Thermal Current (Ith)<40°C	10 A	10 A	10 A
Rated operating voltage (up to)	660 V	660 V	660 V

Dimensions (AC Coil)

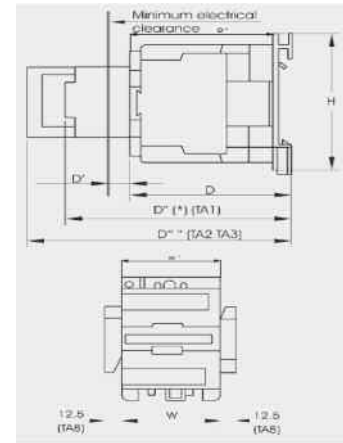

Type	A16C-4011	A16C-5011	A16C-6511
W	75	75	75
H	127	127	127
D	171	171	171
D'	12	12	12
D''	145	145	145
D'''	202	202	202
D*	181	181	181

Dimensions (DC Coil)

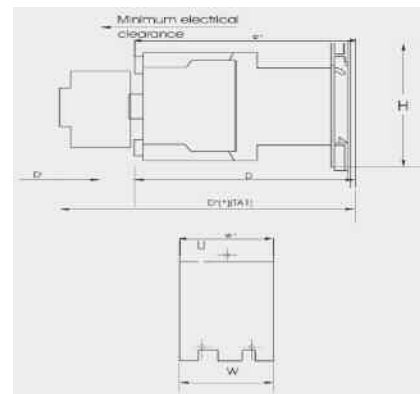

Type	A16C-4011	A16C-5011	A16C-6511
W	75	75	75
H	127	127	127
D	171	171	171
D'	12	12	12
D''	202	202	202
D*	181	181	181

95A Frame
3 Pole Contactors
- 80A (AC3)



With AC Coil

A16C-8011

COIL VOLTAGES*
3 Pole with One NO Built in Auxiliary

Coil Voltage	Coil Hertz	Part No.
24VAC	50/60 Hz	A16C-8011-B7
120VAC	50/60 Hz	A16C-8011-G7
230VAC	50/60 Hz	A16C-8011-P7
480VAC	60 Hz *	A16C-8011-T6

* 50 Hz versions available upon request

CURRENT RATINGS

Maximum Current

AC-3 Inductive	80 A
AC-1 Continuous	125 A

HP RATINGS

Maximum HP Single Phase

120V	7.5 HP
230V	15 HP

Maximum HP Three Phase

200V	25 HP
230V	25 HP
480V	60 HP
600V	60 HP

**OVERLOAD†
RELAYS**



Setting Range (A)	Part No.
30-40	A16CR40-40A
37-50	A16CR65-50A

C Contactors

95A Frame Specifications and Dimensions

3 Pole Contactors - 80A (AC3)

General Technical Information

Rated insulation voltage (Ui)	1000V (according to IEC60947-4-1)
Conforming to standards	NFC EN60947, VDE0660, BSEN60947, IEC60947 & IS13947
Approvals	UL
Protection (Conforming to VDE0106)	Protection against direct finger contact
Temperature rating - Storage	-60°C to +80°C
- Operation	-5°C to +55°C (0.8 to 1.1Uc)
- Permissible	-60°C to +80°C for operation at Uc
Maximum operating altitude	3000 Meters (without derating)

Pole Characteristics

AC-3 Inductive Rating	80 A	95 A
Type (with 1NO & 1NC Aux.)	A16C-8011	A16C-9511
Number of poles (Power)	3	3
Power + Auxiliary	3+2	3+2
Max. Power Contact Wire (mm ² /AWG)	50 / 1	50 / 1
Rated current (AC3 up to 440V@55°C)	80 A	95 A
Rated operating voltage (up to)	690 V	690 V
Frequency (of operational current)	25-400 Hz	25-400 Hz
Rated Thermal Current (Ith)<40°C	125 A	125 A
Rated making/break capacity		
Make - Irms conforming to IEC-60947-4	1,100 A	1,200 A
Break - Irms conforming to 223-440V	1,100 A	1,100 A
Break - IEC-60947-4 500V	1,000 A	1,100 A
Break - IEC-60947-4 660-690V	640 A	640 A
Average impedance per pole (Max. At Ith and 50Hz Milli)	0.8 Max.	0.8 Max.
Power dissipation (per pole for the above operational currents) AC-3	5.1 W	7.2 W

Dimensions (AC Coil)

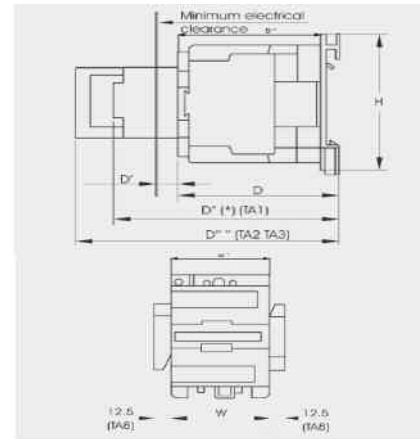

Type	A16C-8011	A16C-9511
W	85	85
H	127	127
D	120	120
D'	12	12
D''	153	153
D'''	173	173
D*	140	140

Control Circuit Characteristics

Rated control circuit volts. (Uc)	12 - 660 V	12 - 660 V		
Control voltage limits (0 < 55° C)	0.8 - 1.1 Uc	0.8 - 1.1 Uc		
Operational (50 or 60Hz Coil)				
Drop out (50 or 60Hz Coil)	0.3 - 0.6 Uc	0.3 - 0.6 Uc		
Operational(50/60Hz Coil)	0.85 - 1.1 Uc	0.85 - 1.1 Uc		
AC Coil	Inrush	60 Hz Coil	220 VA	220 VA
	Average consumption	50/60 Hz Coil	245 VA	245 VA
		COS O	0.75	0.75
	at 20°C and at Sealed	60 Hz Coil	22 VA	22 VA
		50/60 Hz Coil	26 VA	26 VA
	COS O	0.3	0.3	
Average operating time at Uc	Closing time	20-35 msec	20-35 msec	
	Opening time	06-20 msec	06-20 msec	
Mechanical Life Cycles (durability)	4 x 10 ⁷	4 x 10 ⁷		
Maximum Operating Rate cycles/hr	3,600	3,600		

Dimensions (DC Coil)

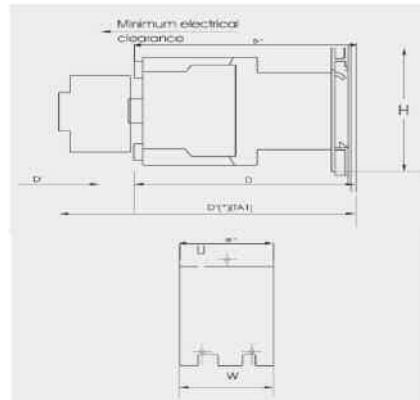

Type	A16C-8011	A16C-9511
W	85	85
H	127	127
D	181	181
D'	12	12
D''	210	210
D*	181	181

Rated control circuit volts. (Uc)	12 - 660 V	-	
Control voltage limits (0 < 55° C)	0.8 - 1.1 Uc	-	
Operational Standard Coil			
Average consumption DC	Drop Out	0.1 - 0.3 Uc	-
	DC Inrush	22 W	-
at 20°C and at Uc	DC Sealed	22 W	-
	Closing time	95-130 msec	-
Average operating time at Uc	Opening time	20-35 msec	-
Mechanical Life Cycles (durability)		20 x 10 ⁷	-
Maximum Operating Rate cycles/hr		3,600	-

Integral Auxiliary Characteristics

Rated Thermal Current (Ith)<40°C	10 A	10 A
Rated operating voltage (up to)	660 V	660 V

Overload Relays

Coil Voltages (Class 10) & Part Numbers



Setting Range (A)	Part Number	Standard Power Rating of 3 Phase Motors at 50/60 Hz Category AC-3					Back Up Fuse Rating Rating of:	
		220V KW	380V KW	415V KW	440V KW	660V KW	aM(A)	g1 (A)
1.6 to 2.5	A16CR09-2.5A	0.37	0.75	1.1	1.1	1.5	4	6
2.5 to 4	A16CR09-4A	0.75	1.5	1.5	1.5	3	6	10
4 to 6	A16CR09-6A	1.1	2.2	2.2	2.2	4	8	16
5.5 to 8	A16CR09-8A	1.5	3	3.7	3.7	5.5	12	20
7 to 10	A16CR09-10A	2.2	4	4	4	7.5	12	20
9 to 13	A16CR12-13A	3	5.5	5.5	5.5	10	16	25
12 to 18	A16CR18-18A	4	7.5	9	9	15	20	35
17 to 25	A16CR25-25A	5.5	11	11	11	18.5	25	50
23 to 32	A16CR32-32A	7.5	15	15	15	-	40	63
28 to 36	A16CR32-36A	9	15	18.5	18.5	-	40	80
30 to 40	A16CR40-40A	10	18.5	22	22	30	40	100
37 to 50	A16CR65-50A	11	22	25	25	37	63	100

Overload Relays

General Technical Information

Conforming to standards	IEC 60747-1, IEC 60947-4-1, NFCEN 60947-4-1, VDE 0660a, BSEN 60947
Approvals	UL, IEC
Protection (Conforming to VDE0106)	Protection against direct finger contact: IP 2X
Temperature rating - Storage	-60°C to +80°C
- Operation, without derating	-25°C to +60°C
- Min & Max operating temperature	-40°C to +70°C
Shock resistance (acceleration)	15gn - 11ms, conforming to IEC 68-2-7
Vibration resistance (acceleration)	6 gn, conforming to IEC 68-2-6
Dielectric strength at 50Hz	6 kV, conforming to IEC 225-5
Impulse withstand voltage	7 kV, conforming to IEC 801-5

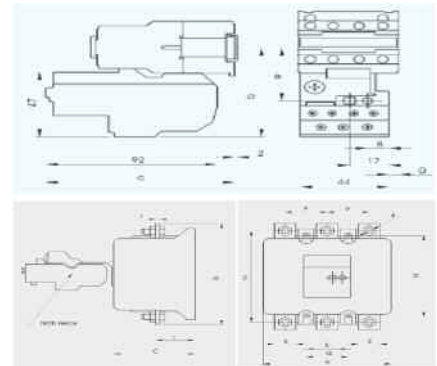

Electrical Characteristics of Power Circuit

Type	A16CR09-2.0A to A16CR12-13A	A16CR18-18A	A16CR25-25A to A16CR65-65A
Tripping Class	10	10	10
Rated operating voltage (up to)	600 V	600 V	600 V
Rated impulse withstand voltage (Uimp)	6 kV	6 kV	6 kV
Frequency limits (of operational current)	0... 400 Hz	0... 400 Hz	0... 400 Hz
Setting range	0.1 - 13 A	16 - 18 A	17 - 70 A
Conductor size (Min/Max) without ferrule	16 AWG/8 AWG	16 AWG/8 AWG	12 AWG/2 AWG
Conductor size (Min/Max) with ferrule	17 AWG/12 AWG	17 AWG/10 AWG	12 AWG/2 AWG
Conductor size (Min/Max) solid conductor	17 AWG/10 AWG	16 AWG/12 AWG	12 AWG/2 AWG

Operating Characteristics

Temperature compensation	-25°C to +60°C	-30°C to +60°C	-30°C to +60°C	-20°C to +60°C
Tripping threshold (to IEC 6047-4-1)	1.14 A + 0.06in	1.14 A + 0.06in	1.14 A + 0.06in	1.14 A + 0.06in
Sensitivity to phase failure		Tripping current 25% above In		

Auxiliary Contact Characteristics

Conventional thermal current	5 A					
Maximum operating consumption (AC)	34 V	48 V	110 V	220 V	380 V	600 V
Coil of control contacts	100 VA	200 VA	400 VA	600 VA	600 VA	600 VA
	24 V	48 V	110 V	220 V	440 V	-
Short circuit protection	100 W	100 W	50 W	45 W	25 W	-
Conductor size (Min/Max) without ferrule	17 AWG / 14 AWG					
Conductor size (Min/Max) with ferrule	17 AWG / 14 AWG					
Conductor size (Min/Max) solid conductor	17 AWG / 14 AWG					
Screw torque	1.85 Nm					

For Overload Relays A16CR32-32A to A16CR32-36A

Contactors (AC Coils)	b	c	e	g
A16C-2510(01)	97.5	98	60	1.5
A16C-3210(01)	97.5	98	60	0.5
Contactors (DC Coils)	b	c	e	g
A16C-2510(01)	97.5	155	60	1.5
A16C-3210(01)	97.5	155	60	0.5

For Overload Relays A16CR40-40A to A16CR65-93A

Contactors (AC Coils)	b	c	e	g
AC16C-4011	111	119	72.4	4.5
AC16C-5011	111	119	72.4	4.5
AC16C-6511	111	119	72.4	4.5
AC16C-8011	115.5	123.4	76.9	9.5
AC16C-9511	115.5	123.4	76.9	9.5
Contactors (DC Coils)	b	c	e	g
AC16C-4011	111	176	72.4	4.5
AC16C-5011	111	176	72.4	4.5
AC16C-6511	111	176	72.4	4.5
AC16C-8011	115.5	179.4	76.9	9.5

For Overload Relays A16CR09-0.16A to A16CR25-25A

For Overload Relays A16CR105 to A16CR630

Amp	a	b	C	G	H	L	M	P	S	t
105	126	160	81	40	120	56	140	40	20	3
125	126	160	81	40	120	56	140	40	20	3
160	126	160	81	40	120	56	140	140	20	3
200	126	160	81	40	120	56	140	140	20	3
250	171	182	120	49	140	45	157	48	25	4
315	171	182	120	49	140	45	157	48	25	4
400	171	182	120	49	140	45	157	48	25	4
500	171	194	120	49	140	46	164	55	25	4
630	171	194	120	49	140	46	164	55	30	4

Definitions

Common Utilization Categories

Utilization Category	Typical Application
AC-1	Non-inductive or slightly inductive loads, example: resistive furnaces, heaters
AC-2	Slip-ring motors: switching off
AC-3	Squirrel-cage motors: starting, switches off motors during running time
AC-4	Squirrel-cage motors: starting, plugging, inching
AC-5a	Switching of discharge lamps
AC-5b	Switching of incandescent lamps
AC-6a	Switching of transformers
AC-6b	Switching of capacitor banks
AC-7a	Slightly inductive loads in household appliances: examples: mixers, blenders
AC-7b	Motor-loads for household appliances: examples: fans, central vacuum
AC-8a	Hermetic refrigerant compressor motor control with manual resetting overloads
AC-8b	Hermetic refrigerant compressor motor control with automatic resetting overloads
AC-12	Control of resistive loads and solid state loads with opto-coupler isolation
AC-13	Control of solid state loads with transformer isolation
AC-14	Control of small electromagnetic loads
AC-15	Control of A.C. electromagnetic loads
AC-20	Connecting and disconnecting under no-load conditions
AC-21	Switching of resistive loads, including moderate overloads
AC-22	Switching of mixed resistive and inductive loads, including moderate overloads
AC-23	Switching of motor loads or other highly inductive loads
AC-31A	Non-inductive or weakly inductive loads
AC-33A	Motor loads or mixed loads including motors, resistors and incandescent lamps
AC-35A	Gas discharge lamp load
AC-36A	Incandescent lamp load
AC-40	Distribution circuits of mixed resistive and inductive loads
AC-41	Non-inductive or weakly inductive loads, resistance furnaces
AC-42	Slip ring motors: Starting, switching off
AC-43	Squirrel cage motors: Starting, switching off during operation
AC-44	Squirrel cage motors: Starting, counter-current braking or reversing
AC-45a	Switching of gas discharge lamps
AC-45b	Switching incandescent lamps

Common Utilization Categories

Utilization Category	Typical Application
AC-51	Induction-free or slightly inductive loads, resistance furnaces
AC-52a	Control of the stator winding of a slip-ring motor: 8-hour operation with starting currents for starting processes, maneuvering, operation
AC-52b	Control of the stator winding of a slip ring motor: Intermittent operation
AC-53a	Control of a squirrel cage motor: 8-hour operation with starting currents for starting processes, maneuvering, operation
AC-53b	Control of a squirrel cage motor: Intermittent operation
AC-55a	Switching of electrical controls of discharge lamps
AC-55b	Switching incandescent lamps
AC-56a	Switching transformers
AC-56b	Switching of capacitor batteries
AC-58a	Control of a hermetically sealed refrigeration compressor motor with automatic reset of overload releases: 8-hour operation with starting currents for starting, maneuvering, operation
AC-58b	The control of a hermetically sealed refrigeration compressor motor with automatic reset of the overload trips: Intermittent operation
AC-140	Control of small electromagnetic loads with holding current ≤ 0.2 A; e.g. contactor relays
DC-1	Non Inductive or slightly inductive loads, resistance furnaces, heaters
DC-3	Shunt-motors, starting, plugging, inching, dynamic braking of motors
DC-5	Series-motors, starting, plugging, inching, dynamic braking of motors
DC-6	Switching of incandescent lamps
DC-12	Control of resistive loads and solid state loads with opto-coupler isolation
DC-13	Control of D.C. electromagnetics
DC-14	Control of D.C. electromagnetic loads having economy resistors in the circuit
DC-20	Connecting and disconnecting under no-load conditions
DC-21	Switching of resistive loads, including moderate overloads
DC-22	Switching of mixed resistive and inductive loads, including moderate overloads (i.e. shunt motors)
DC-23	Switching of highly inductive loads (i.e. series motors)

Quick Reference

Altech PC Series Contactors

- Minimum size & Maximum performance
- Ambient temperatures – 40°C up to + 90°C
- Designed for the operation under extreme conditions (heat, dust, sand, high humidity, vibrations, shock)
- Bounce free, self cleaning aux. contacts, suitable for switching electronic circuits => highest contact reliability
- Current ratings from 10A to 115A
- Adjustable Overload Relays from 0.18A to 85A

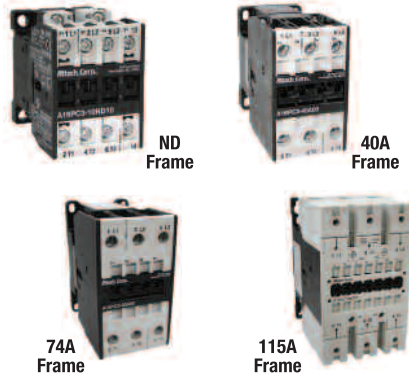

Popular Applications for the contactors:

- Motor Control
- Pumps
- Machine Tools
- Printing Machines
- Packaging Machines
- Compressors
- HVAC
- Cranes
- Elevators & Escalators

3 Pole Contactors (Normally Open)

Amperage Rating	AC-3 Rating	AC-1 Rating	Auxiliary		Coil Voltage			
			NO	NC	24 VAC	24 VDC	110-120 VAC	200-240 VAC
10 A	25 A	1	0	A16PC3-10ND10-AC24V	A16PC3-10ND10-DC24V	A16PC3-10ND10-AC110V	A16PC3-10ND10-AC180V	
14 A	25 A	1	0	A16PC3-14ND10-AC24V	A16PC3-14ND10-DC24V	A16PC3-14ND10-AC110V	A16PC3-14ND10-AC180V	
18 A	30 A	1	0	A16PC3-18ND10-AC24V	A16PC3-18ND10-DC24V	A16PC3-18ND10-AC110V	A16PC3-18ND10-AC180V	
22 A	30 A	1	0	A16PC3-22ND10-AC24V	A16PC3-22ND10-DC24V	A16PC3-22ND10-AC110V	A16PC3-22ND10-AC180V	
24 A	50 A	0	0	A16PC3-24A00-AC24V	A16PC3-24A00-DC24V	A16PC3-24A00-AC110V	A16PC3-24A00-AC180V	
32 A	65 A	0	0	A16PC3-32A00-AC24V	A16PC3-32A00-DC24V	A16PC3-32A00-AC110V	A16PC3-32A00-AC180V	
40 A	80 A	0	0	A16PC3-40A00-AC24V	A16PC3-40A00-DC24V	A16PC3-40A00-AC110V	A16PC3-40A00-AC180V	
50 A	110 A	0	0	A16PC3-50A00-AC24V	A16PC3-50A00-DC24V	A16PC3-50A00-AC110V	A16PC3-50A00-AC180V	
62 A	120 A	0	0	A16PC3-62A00-AC24V	A16PC3-62A00-DC24V	A16PC3-62A00-AC110V	A16PC3-62A00-AC180V	
74 A	130 A	0	0	A16PC3-74A00-AC24V	A16PC3-74A00-DC24V	A16PC3-74A00-AC110V	A16PC3-74A00-AC180V	
90 A	160 A	0	0	A16PC3-90A00-24V	-	A16PC3-90A00-110V	A16PC3-90A00-230V	
115 A	200 A	0	0	A16PC3-115A00-24V	-	A16PC3-115A00-110V	A16PC3-115A00-230V	

Overload Relays



Setting Range	Standard	Manual Reset	For Contactor Size
0.12-0.18 A	APOL3/32-0.18	APOL12/16E-0.18-C3	A16PC3-10 to A16PC3-40
0.18-0.27 A	APOL3/32-0.27	APOL12/16E-0.27-C3	
0.27-0.4 A	APOL3/32-0.4	APOL12/16E-0.4-C3	
0.4-0.6 A	APOL3/32-0.6	APOL12/16E-0.6-C3	
0.6-0.9 A	APOL3/32-0.9	APOL12/16E-0.9-C3	
0.8-1.2 A	APOL3/32-1.2	APOL12/16E-1.2-C3	
1.2-1.8 A	APOL3/32-1.8	APOL12/16E-1.8-C3	
1.8-2.7 A	APOL3/32-2.7	APOL12/16E-2.7-C3	
2.7-4 A	APOL3/32-4	APOL12/16E-4-C3	
4-6 A	APOL3/32-6	APOL12/16E-6-C3	
6-9 A	APOL3/32-9	APOL12/16E-9-C3	A16PC3-24 to A16PC3-40
8-11 A	APOL3/32-11	APOL12/16E-11-C3	
10-14 A	APOL3/32-14	APOL12/16E-14-C3	
13-18 A	APOL3/32-18	APOL12/16E-18-C3	
17-24 A	APOL3/32-24	APOL12/16E-23-C3	
23-32 A	APOL3/32-32	APOL12/16E-30-C3	A16PC3-50 to A16PC3-74
28-42 A	-	APOL3/42 42	
20-28 A	-	APOL3/74 28	
28-42 A	-	APOL3/74 42	
40-52 A	-	APOL3/74 52	
52-65 A	-	APOL3/74 65	A16PC3-90 to A16PC3-74
60-74 A	-	APOL3/74 74	
60-90 A	-	APOL85/90	
80-120 A	-	APOL85/120	

Accessories

Suppressor Units

	Voltage Range	Part No.
	12 - 48V AC-DC	AP-RC-C3N-24
	48 - 127V AC-DC	AP-RC-C3N-110
	110 - 230V AC/DC	AP-RC-C3N-230
	230-415 VAC/DC	AP-RC-C3N400

Indicators

	Coil Voltage	Part No.
	24-120V AC/DC	AP-C2UNR
	Coil Current	Part No.
	24-660V AC/DC Green	Green = AP-C2ING
	24-660V AC/DC (Red)	Red = AP-C2INR

Front Mount Auxiliary

	Low Level Switching	1 NC = AP-HN01
	1 NO = AP-HN10	
	Up to 25 A Switching	1 NC = AP-HA01
	1 NO = AP-HA10	

Mechanical Contactor Interlock

For ND & 40A Frames
AP-LG10889

Please consult Altech for technical and dimensional information.

Altech PC Series Contactors

MINI Frame

with built-in
auxilliary switch



AC



DC

A16PC1-09D10

A16PC1-12D10

COIL VOLTAGES*

AC Coil (60Hz)**

	Part No.	Part No.
24V	A16PC1-09D10-AC24V	A16PC1-12D10-AC24V
120-125V	A16PC1-09D10-AC110V	A16PC1-12D10-AC110V

DC Coil (Solenoid operated coil - low power consumption)

24V	A16PC1-09D10-DC24V	A16PC1-12D10-DC24V
-----	--------------------	--------------------

NOTES: Parts above include 1 N.O. (10) auxiliary contact built-in. Please specify 01 in part number for N.C. auxiliary contact configuration.

CURRENT RATINGS

General Use (AC1)	15A (20A)	20A (20A)
Motor FLA@600V		
AC3@380-400V	9A	12A

HP RATINGS

	1 Phase	3 Phase	1 Phase	3 Phase
110-120V	1/2	1 1/2	3/4	2
200V	1	3	1 1/2	3
220-240V	1 1/2	3	2	3
440-480V	-	5	-	7 1/2
550-600V	-	7 1/2	-	10

OVERLOAD† RELAYS



Manual Reset
Part No.

Setting Range	Part No.
0.12 - 0.18	APOL12/16E 0.18 C1
0.18 - 0.27	APOL12/16E 0.27 C1
0.27 - 0.4	APOL12/16E 0.4 C1
0.4 - 0.6	APOL12/16E 0.6 C1
0.6 - 0.9	APOL12/16E 0.9 C1
0.8 - 1.2	APOL12/16E 1.2 C1
1.2 - 1.8	APOL12/16E 1.8 C1
1.8 - 2.7	APOL12/16E 2.7 C1
2.7 - 4	APOL12/16E 4 C1
4 - 6	APOL12/16E 6 C1
6 - 9	APOL12/16E 9 C1
8 - 11	APOL12/16E 11 C1
10 -14	APOL12/16E 14 C1

*Other coil voltages available upon request.

** (50Hz available upon request)

† Stocked parts in **BOLD**

Suppressor Units



Voltage Range		Part No.
12 - 48V AC/DC	160nF / 22 Ohm	AP-RC-C1 24
48 - 127V AC/DC	6800nF / 270 Ohm	AP-RC-C1 110
110 - 250V AC/DC	220nF / 2200 Ohm	AP-RC-C1 230

AUXILIARY CONTACT BLOCKS



NO	NC	Part Number
1	1	AP-HCM-11
-	2	AP-HCM-02
2	-	AP-HCM-20
1	3	AP-HCM-13
4	-	AP-HCM-40
2	2	AP-HCM-22
-	4	AP-HCM-04
3	1	AP-HCM-31

DIMENSIONS

AC and DC operated
with screw terminals
C1-09D...
C1-12D...

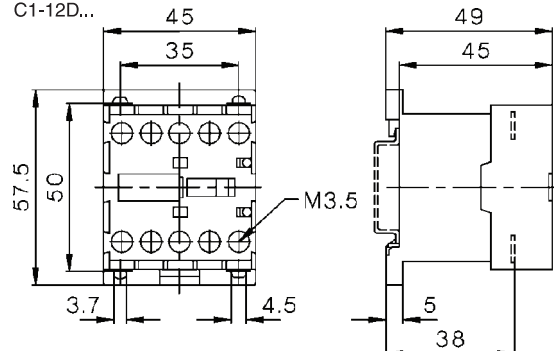

Altech C Series Contactors

- Compact Modular Design offering flexibility and space savings
- Low Power Consumption Coils provide energy savings and allow down sizing
- Finger Safe IEC rated IP20 terminals
- Built in Auxiliary Contact one NO standard (one NC upon request)
- Easy to Install featuring DIN Rail or bolt on mounting
- Protective Security Cover prevents accidental manual operation
- Superior Design offers high mechanical and electrical life
- Short Circuit Protection - Type 1 & 2 Co-ordination





Popular Applications for the contactors:

- Motor Control
- Pumps
- Machine Tools
- Printing Machines
- Packaging Machines
- Compressors
- HVAC
- Cranes
- Elevators & Escalators

3 Pole Contactors (Normally Open)

Amperage		Auxiliary		Coil Voltage					
AC-3 Rating	AC-1 Rating	NO	NC	24 VAC	24 VDC	120 VAC	208 VAC	230 VAC	480 VAC
9 A	20A	1	0	A16C-0910-B7	A16DC-0910-BD	A16C-0910-G7	A16C-0910-L6	A16 C-0910-P7	A16C-0910-T6
12 A	25A	1	0	A16C-1210-B7	A16DC-1210-BD	A16C-1210-G7	—	A16C-1210-P7	—
18 A	32A	1	0	A16C-1810-B7	A16DC-1810-BD	A16C-1810-G7	—	A16C-1810-P7	A16C-1810-T6
25 A	40A	1	0	A16C-2510-B7	A16DC-2510-BD	A16C-2510-G7	A16C-2510-L6	A16C-2510-P7	—
32 A	50A	1	0	A16C-3210-B7	A16DC-3210-BD	A16C-3210-G7	A16C-3210-L6	A16C-3210-P7	A16C-3210-T6
40 A	60A	1	1	A16C-4011-B7	A16DC-4011-BD	A16C-4011-G7	A16C-4011-L6	—	—
50 A	80A	1	1	—	—	A16C-5011-G7	—	A16C-5011-P7	—
65 A	80A	1	1	—	—	A16C-6511-G7	—	A16C-6511-P7	—
80 A	125A	1	1	A16C-8011-B7	—	A16C-8011-G7	—	A16C-8011-P7	A16C-8011-T6

Auxiliary Contact Blocks (10A)

	No. of Contacts	Contacts		Part Number	For Contactors
		NO	NC		
 Front Mount - 4 Pole	4	2	2	A16CF22	For use with All Contactor Sizes
		1	3	A16CF13	
		4	0	A16CF40	
		0	4	A16CF04	
		3	1	A16CF31	
		1	1	A16CF11	
 Front Mount - 2 Pole	2	2	0	A16CF20	For use with All Contactor Sizes
		0	2	A16CF02	
	1	1	0	A16CF10	
		0	1	A16CF01	
 Side Mount - 2 Pole	2	1	1	A16CS11	For Contactors Below 95 A
			2	0	

Please consult Altech for technical and dimensional information.

Contactors

MC-Series



UL508
E108780

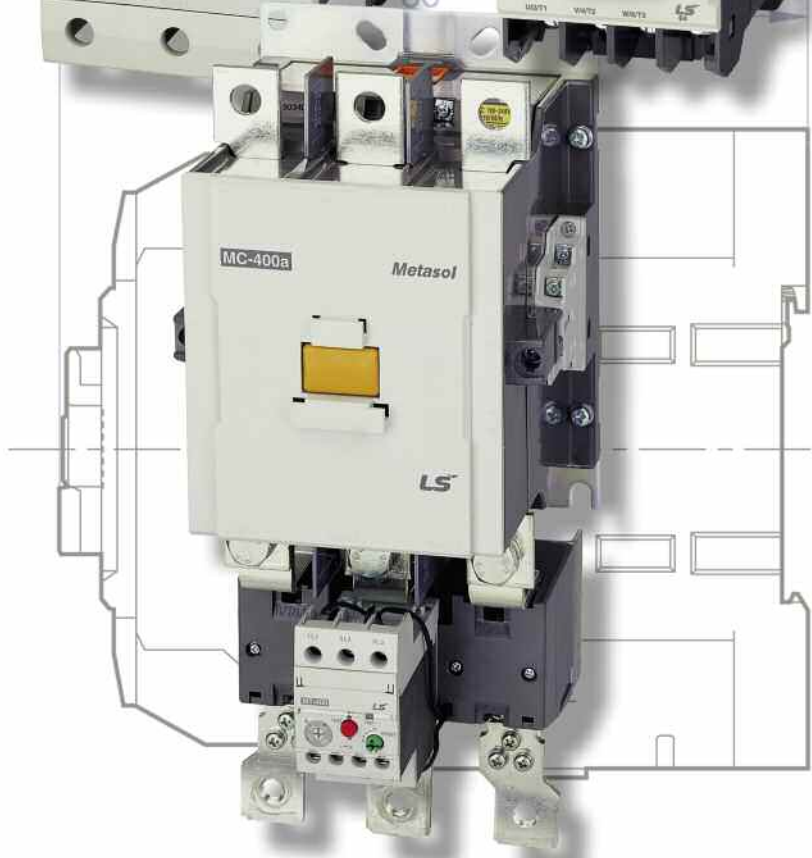

Standards and Certifications

- UL508
- IEC 60947-2 & IEC 60947-4-2
- CSA C22.2 No.14

Features

- 8 Frame Sizes
- 1/2HP up to 600HP @ 480V AC
- Screw Terminals (Lug Terminals Available)
- Direct Mounting Overload Relays
- Optional accessories
 - Additional Auxiliary contacts
 - Replacement Coils
 - Reversing Wiring Sets and Interlocks
 - Direct Wiring Adapters fro MMS
 - Coil surge Suppressors

General Specifications

Maximum Voltage	600V AC
Rated Frequency	50/60Hz
Operating Temperature	-5°C (23°F) to +40°C (104°F)
Degree of protection	IP20
Resistance to Vibration (5-300Hz)	> 15g
Flame Resistance	According to UL94

Terminal Size Acceptability and Torque

Wire Type	22AF	40AF	65-100AF	150AF	225AF	400AF	800AF
Solid	18-8 AWG	14-8AWG	12-4AWG	10AWG-1/0	8AWG - 300kcmil	8AWG - 400kcmil	2/0 - 700kcmil
Stranded	18-10AWG	14-8AWG	12-4AWG	10AWG-1/0	8AWG - 300kcmil	8AWG - 400kcmil	2/0 - 700kcmil
Ferrule	18-10AWG	18-10AWG	12-4AWG	10AWG-1/0	8AWG - 300kcmil	8AWG - 400kcmil	2/0 - 700kcmil
Torque	20 lb-in.	35 lb-in.	35 lb-in.	87 lb-in.	130 lb-in.	200 lb-in.	235 lb-in.

Contactors

3 Pole / Frame Size 22AF

Altech Corp.[®]



includes UA-1-11
Auxiliary switch,
(1NO/1NC)

Additional Auxiliaries
and other accessories
see page 11-13



22AF

Type	MC-9B	MC-12B	MC-18B	MC-22B
Number of Poles	3	3	3	3
NEMA Size	00	00	0	1
Standard Auxiliaries	1NO/1NC	1NO/1NC	1NO/1NC	1NO/1NC

	Coil Voltage	Frequency	Part. No.	Part. No.	Part. No.	Part. No.
AC Coil	24V	50/60 Hz	MC-9B-AC24V	MC-12B-AC24V	MC-18B-AC24V	MC-22B-AC24V
	120V	50/60 Hz	MC-9B-AC120V	MC-12B-AC120V	MC-18B-AC120V	MC-22B-AC120V
	208V	60 Hz	MC-9B-AC208V	MC-12B-AC208V	MC-18B-AC208V	MC-22B-AC208V
	230V	50/60 Hz	MC-9B-AC230V	MC-12B-AC230V	MC-18B-AC230V	MC-22B-AC230V
	480V	60 Hz	MC-9B-AC480V	MC-12B-AC480V	MC-18B-AC480V	MC-22B-AC480V

Other AC Coil Voltages Available:

60 Hz: 277V, 600V

50/ 60Hz: 48V, 100V, 110V, 200V, 220V, 240V, 380V, 415V, 440V, 500V, 550V

DC Coil	12V	—	MC-9B-DC12V	MC-12B-DC12V	MC-18B-DC12V	MC-22B-DC12V
	24V	—	MC-9B-DC24V	MC-12B-DC24V	MC-18B-DC24V	MC-22B-DC24V

Other DC Coil Voltages Available:

20V, 48V, 60V, 80V, 100V, 110V, 125V, 200V, 220V, 250V

HP Rating / UL508

		HP	HP	HP	HP
	Continuous current	25A	25A	40A	40A
Single phase	110~120V	0.5	0.75	1	2
	220~240V	1.5	2	3	3
Three phase	200~208V	2	3	5	7.5
	220~240V	3	5	7.5	10
	440~480V	5	7.5	10	15
	550~600V	7.5	10	15	20

Overload Relays

(Class 10A,
Differential Typical)



MT-32

Setting Ranges (A)

Frame Size 22AF

0.1-0.16A	MT-32/3K-0.16
0.16-0.25A	MT-32/3K-0.25
0.25-0.4A	MT-32/3K-0.4
0.4-0.63A	MT-32/3K-0.63
0.63-1A	MT-32/3K-1
1-1.6A	MT-32/3K-1.6
1.6-2.5A	MT-32/3K-2.5
2.4-4A	MT-32/3K-4
4-6A	MT-32/3K-6
5-8A	MT-32/3K-8
6-9A	MT-32/3K-9
7-10A	MT-32/3K-10
9-13A	MT-32/3K-13
12-18A	MT-32/3K-18
16-22A	MT-32/3K-22
18-25A	MT-32/3K-25
22-32A	MT-32/3K-32
28-40A	MT-32/3K-40

Drawings and other technical information can be found on page 14-20.

Contactors

3 Pole / Frame Size 40AF / 65F



includes 2 x UA-1-11
Auxiliary switch,
(2NO/2NC)

Additional Auxiliaries
and other accessories
see page 11-13



includes 2 x UA-1-11
Auxiliary switch,
(2NO/2NC)

Additional Auxiliaries
and other accessories
see page 11-13

Type	40AF		65AF	
	MC-32A	MC-40A	MC-50A*	MC-65A*
Number of Poles	3	3	3	3
NEMA Size	1	1	2	2
Standard Auxiliaries	2NO/2NC	2NO/2NC	2NO/2NC	2NO/2NC

AC Coil	Coil Voltage	Frequency	Part. No.	Part. No.	Part. No.	Part. No.
		24V	50/60 Hz	MC-32A-AC24V	MC-40A-AC24V	MC-50A-AC24V
	120V	50/60 Hz	MC-32A-AC120V	MC-40A-AC120V	MC-50A-AC120V	MC-65A-AC120V
	208V	60 Hz	MC-32A-AC208V	MC-40A-AC208V	MC-50A-AC208V	MC-65A-AC208V
	230V	50/60 Hz	MC-32A-AC230V	MC-40A-AC2300V	MC-50A-AC230V	MC-65A-AC230V
	480V	60 Hz	MC-32A-AC480V	MC-40A-AC480V	MC-50A-AC480V	MC-65A-AC480V

Other AC Coil Voltages Available:

60 Hz: 277V, 600V
50/ 60Hz: 48V, 100V, 110V, 200V, 220V, 240V, 380V, 415V, 440V, 500V, 550V

DC Coil	Coil Voltage	Frequency	Part. No.	Part. No.	Part. No.	Part. No.
		12V	—	MC-32A-DC12V	MC-40A-DC12V	MC-50A-DC12V
	24V	—	MC-32A-DC24V	MC-40A-DC24V	MC-50A-DC24V	MC-65A-DC24V

Other DC Coil Voltages Available:

20V, 48V, 60V, 80V, 100V, 110V, 125V, 200V, 220V, 250V

HP Rating / UL508	Setting Ranges (A)	HP	HP	HP	HP
		50A	60A	70A	100A
Continuous current		50A	60A	70A	100A
Single phase	110~120V	2	3	3	5
	220~240V	5	7.5	10	15
Three phase	200~208V	7.5	15	20	25
	220~240V	10	15	25	30
	440~480V	20	30	40	50
	550~600V	25	30	50	60

Overload Relays
(Class 10A,
Differential Typical)



MT-63

Setting Ranges (A)	Frame Size 40AF	Frame Size 65AF
0.1-0.16A	MT-32/3K-0.16	-
0.16-0.25A	MT-32/3K-0.25	-
0.25-0.4A	MT-32/3K-0.4	-
0.4-0.63A	MT-32/3K-0.63	-
0.63-1A	MT-32/3K-1	-
1-1.6A	MT-32/3K-1.6	-
1.6-2.5A	MT-32/3K-2.5	-
2.4-4A	MT-32/3K-4	-
4-6A	MT-32/3K-6	MT-63/3K-6
5-8A	MT-32/3K-8	MT-63/3K-8
6-9A	MT-32/3K-9	MT-63/3K-9
7-10A	MT-32/3K-10	MT-63/3K-10
9-13A	MT-32/3K-13	MT-63/3K-13
12-18A	MT-32/3K-18	MT-63/3K-18
16-22A	MT-32/3K-22	MT-63/3K-22
18-25A	MT-32/3K-25	MT-63/3K-25
22-32A	MT-32/3K-32	-
28-40A	MT-32/3K-40	MT-63/3K-40
34-50A	-	MT-63/3K-50
45-65A	-	MT-63/3K-60

* Lug terminals available; please add "L" to part number, e.g. MC-75A-AC24V-L.
Drawings and other technical information can be found on page 14-20.

Contactor 3 Pole

Contactors

3 Pole / Frame Size 100AF



Altech Corp.[®]

includes 2 x UA-1-11
Auxiliary switch,
(2NO/2NC)

Additional Auxiliaries
and other accessories
see page 11-13

100AF

Type	MC-75A*	MC-85A*	MC-100A*
Number of Poles	3	3	3
NEMA Size	2	3	3
Standard Auxiliaries	2NO/2NC	2NO/2NC	2NO/2NC

	Coil Voltage	Frequency	Part. No.	Part. No.	Part. No.
AC Coil	24V	50/60 Hz	MC-75A-AC24V	MC-85A-AC24V	MC-100A-AC24V
	120V	50/60 Hz	MC-75A-AC120V	MC-85A-AC120V	MC-100A-AC120V
	208V	60 Hz	MC-75A-AC208V	MC-85A-AC208V	MC-100A-AC208V
	230V	50/60 Hz	MC-75A-AC230V	MC-85A-AC230V	MC-100A-AC230V
	480V	60 Hz	MC-75A-AC480V	MC-85A-AC480V	MC-100A-AC480V

Other AC Coil Voltages Available:

60 Hz: 277V, 600V

50/ 60Hz: 48V, 100V, 110V, 200V, 220V, 240V, 380V, 415V, 440V, 500V, 550V

DC Coil	12V	—	MC-75A-DC12V	MC-85A-DC12V	MC-100A-DC12V
	24V	—	MC-75A-DC24V	MC-85A-DC24V	MC-100A-DC24V

Other DC Coil Voltages Available:

20V, 48V, 60V, 80V, 100V, 110V, 125V, 200V, 220V, 250V

HP Rating / UL508

	HP	HP	HP
Continuous current	110A	135A	160A
Single phase	110~120V	5	7.5
	220~240V	15	20
Three phase	200~208V	25	30
	220~240V	30	40
	440~480V	50	75
	550~600V	60	75

Overload Relays

(Class 10A,
Differential Typical)



MT-95

Setting Ranges (A)

Frame Size 100AF

7-10A	MT-95/3K-10
9-13A	MT-95/3K-13
12-18A	MT-95/3K-18
16-22A	MT-95/3K-22
18-25A	MT-95/3K-25
22-32A	MT-95/3K-32
24-36A	MT-95/3K-36
28-40A	MT-95/3K-40
34-50A	MT-95/3K-50
45-65A	MT-95/3K-65
54-75A	MT-95/3K-75
63-85A	MT-95/3K-85
70-95A	MT-95/3K-95
80-100A	MT-95/3K-100

* Lug terminals available; please add "L" to part number, e.g. MC-75A-AC24V-L.

Drawings and other technical information can be found on page 14-20.

Contactors

3 Pole /Frame Size 150AF/225AF



includes 2 x UA-1-11
Auxiliary switch,
(2NO/2NC)

Additional Auxiliaries
and other accessories
see page 11-13



includes 2 x AU-100-11
Auxiliary switch,
(2NO/2NC)

Additional Auxiliaries
and other accessories
see page 11-13

150AF with Lug Terminals

225AF

Type	MC-130A*	MC-150A*	MC-185A	MC-225A
Number of Poles	3	3	3	3
NEMA Size	3	4	4	4
Standard Auxiliaries	2NO/2NC	2NO/2NC	2NO/2NC	2NO/2NC

	Coil Voltage	Frequency	Part. No.	Part. No.	Part. No.	Part. No.
AC Coil	24V	50/60 Hz	MC-130A-AC24V-L	MC-150A-AC24V-L	-	-
	110V	50/60 Hz	MC-130A-AC110V-L	MC-150A-AC110V-L	-	-
	220V	50/60 Hz	MC-130A-AC220V-L	MC-150A-AC220V-L	-	-
	300V	50/60 Hz	MC-130A-AC300V-L	MC-150A-AC300V-L	-	-
	400V	50/60 Hz	MC-130A-AC400V-L	MC-150A-AC400V-L	-	-
	500V	50/60 Hz	MC-130A-AC500V-L	MC-150A-AC500V-L	-	-
DC Coil	12V	-	MC-130A-DC12V-L	MC-150A-DC12V-L	-	-
	24V	-	MC-130A-DC24V-L	MC-150A-DC24V-L	-	-
	110V	-	MC-130A-DC110V-L	MC-150A-DC110V-L	-	-
	220V	-	MC-130A-DC220V-L	MC-150A-DC220V-L	-	-

AC/DC

Common Coil	Coil Voltage					
	AC 50/60Hz	DC				
	24-25V	24V	-	-	MC-185A-24V	MC-225A-24V
	48-50V	48V	-	-	MC-185A-48V	MC-225A-48V
	100-240V	100-220V	-	-	MC-185A-100/200V	MC-225A-100/200V
	265-347V	-	-	-	MC-185A-300V	MC-225A-300V
	380-450V	-	-	-	MC-185A-400V	MC-225A-400V
	440-575V	-	-	-	MC-185A-500V	MC-225A-500V

HP Rating / UL508

		HP	HP	HP	HP
	Continuous current	160A	210A	230A	275A
Single phase	110~120V	10	15	15	15
	220~240V	20	25	30	40
Three phase	200~208V	40	40	60	60
	220~240V	40	50	60	75
	440~480V	75	100	125	150
	550~600V	75	75	125	150

Overload Relays

(Class 10A, Differential Typical)



MT-150

Setting Ranges (A)	Frame Size 150AF	Frame Size 225AF
34-50A	MT-150/3K-50	-
45-65A	MT-150/3K-65	-
54-75A	MT-150/3K-75	-
63-85A	MT-150/3K-85	-
65-100A	-	MT-225/3K-100
80-105A	MT-150/3K-105	-
85-125A	-	MT-225/3K-125
95-130A	MT-150/3K-130	-
110-150A	MT-150/3K-150	-
100-160A	-	MT-225/3K-160
120-185A	-	MT-225/3K-185
160-240A	-	MT-225/3K-240

* Screw terminals available; please remove "-L" from part number, e.g. MC-75A-AC24V.
Drawings and other technical information can be found on page 14-20.

Contactors

3 Pole / Frame Size 400AF



Altech Corp.[®]

includes 2 x AU-100-11
Auxiliary switch,
(2NO/2NC)

Additional Auxiliaries
and other accessories
see page 11-13

Type	MC-265A	MC-330A	MC-400A
Number of Poles	3	3	3
NEMA Size	5	5	5
Standard Auxiliaries	2NO/2NC	2NO/2NC	2NO/2NC

	Coil Voltage		Part. No.	Part. No.	Part. No.
AC/DC	AC 50/60Hz	DC			
Common Coil	100-240V	100-220V	MC-265A-100/200V	MC-330A-100/200V	MC-400A-100/200V
	265-347V	-	MC-265A-300V	MC-330A-300V	MC-400A-300V
	380-450V	-	MC-265A-400V	MC-330A-400V	MC-400A-400V
	440-575V	-	MC-265A-500V	MC-330A-500V	MC-400A-500V

HP Rating / UL508		HP	HP	HP
	Continuous current	300A	350A	450A
Single phase	110~120V	-	-	-
	220~240V	-	-	-
Three phase	200~208V	75	100	125
	220~240V	100	125	150
	440~480V	200	250	300
	550~600V	200	250	300

Overload Relays

(Class 10A,
Differential Typical)



MT-400

Setting Ranges (A)	Frame Size 400AF
85-125A	MT-400/3K-125
100-160A	MT-400/3K-160
120-185A	MT-400/3K-185
160-240A	MT-400/3K-240
200-330A	MT-400/3K-330
260-400A	MT-400/3K-400

Lug Terminals



Part. No.	Frame Size
AJ-220	225AF
AJ-400	400AF
AJ-800	800AF

Drawings and other technical information can be found on page 14-20.

Contactors

3 Pole / Frame Size 800AF



includes 2 x AU-100-11
Auxiliary switch,
(2NO/2NC)

Additional Auxiliaries
and other accessories
see page 11-13

800AF

Type	MC-500A	MC-630A	MC-800A
Number of Poles	3	3	3
NEMA Size	6	6	7
Standard Auxiliaries	2NO/2NC	2NO/2NC	2NO/2NC

AC/DC Common Coil

Coil Voltage	Part. No.		Part. No.		Part. No.	
	AC 50/60Hz	DC				
100-127V	100-110V	MC-500A-100V	MC-630A-100V	MC-800A-100V		
200-240V	200-220V	MC-500A-200V	MC-630A-200V	MC-800A-200V		
265-347V	-	MC-500A-300V	MC-630A-300V	MC-800A-300V		
380-450V	-	MC-500A-400V	MC-630A-400V	MC-800A-400V		
440-575V	-	MC-500A-500V	MC-630A-500V	MC-800A-500V		

Rating / UL508

		HP	HP	HP
Continuous current		580A	660A	900A
Single phase	110~120V	-	-	-
	220~240V	-	-	-
Three phase	200~208V	150	200	200
	220~240V	200	250	300
	440~480V	400	500	600
	550~600V	400	500	600

Overload Relays

(Class 10A,
Differential Typical)



MT-800

Setting Ranges (A)

Setting Ranges (A)	Frame Size 800AF
200-330A	MT-800/3K-330
260-400A	MT-800/3K-400
400-630	MT-800/3K-630
520-800A	MT-800/3K-800

Lug Terminals



Part. No.	Frame Size
AJ-220	225AF
AJ-400	400AF
AJ-800	800AF

Drawings and other technical information can be found on page 14-20.

Reversing Contactors

Reversing contactor consists of:

- Two AC or DC contactors
- Mechanical Interlock
- Wire Set (up to frame size 100A)

Assembled Reversing Contactors

Type	Type
MC-9B/R	MC-130A/R
MC-12B/R	MC-150A/R
MC-18B/R	MC-185A/R
MC-22B/R	MC-225A/R
MC-32A/R	MC-265A/R
MC-40A/R	MC-330A/R
MC-50A/R	MC-400A/R
MC-65A/R	MC-500A/R
MC-75A/R	MC-630A/R
MC-85A/R	MC-800A/R
MC-100A/R	

To create Part No. add "R" after frame size, eg. MC-32A/R-AC120V, MC-32A/R-DC24V, etc.
For available coil voltages see contactor pages 5-10.



MC-40A/R



MC-65A/R



MC-100A/R

Individual Components

Mechanical Interlocks

Interlock Part#	Contactor Type	Auxiliary Contacts
UR-02	MC-9B to MC-100A	2 x NC
AR-180	MC-180A to MC-400A	-
AR-600	MC-500A to MC-800A	-



Interlock unit

UR-02



AR-180

Wire Kits

Interlock Part#	Contactor Frame Size
UW-22	MC-9B to MC-22B
UW-32	MC-32A to MC-40A
UW-63	MC-50A, MC-65A
UW-95	MC-75A, MC-100A



Wire kit

UW-XX

Installation of Interlock and Wire Kits

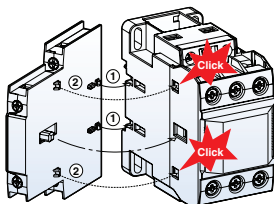

Install the interlock unit on the side of a contactor first. Fit each part as indicated in the figure above.

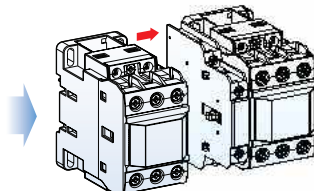

And then install the other contactor on the other side of the interlock unit as shown.

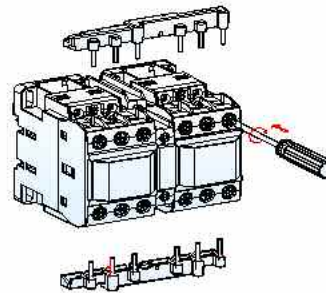

After installing interlock unit wiring kit can be assembled. Wiring kit contains two molded wires - one for line side and the other for load side.

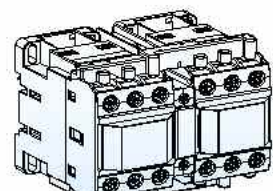

Contactors Accessories

AUXILIARY CONTACTS

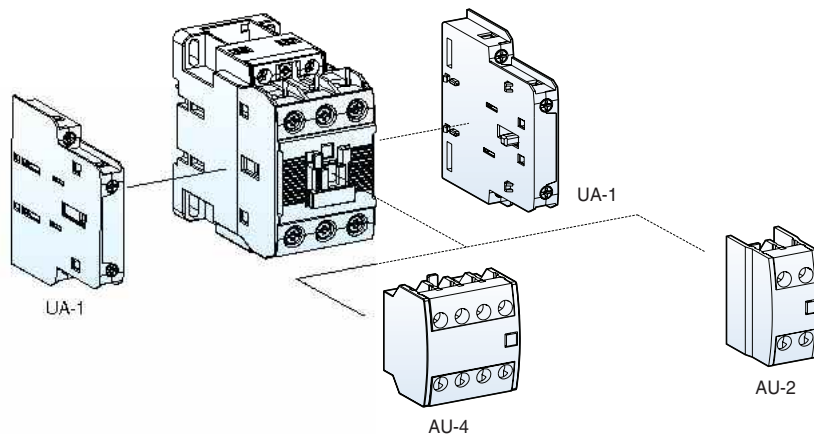

Frame Sizes 22AF - 150AF

Part No.	Poles	Configuration	Mounting	Contact Arrangement
UA-1-11	2	1NO/1NC	Side	
UA-2-20	2	2NO	Front	
UA-2-11	2	1NO/1NC	Front	
UA-2-02	2	2NC	Front	
UA-4-40	4	4NO	Front	
UA-4-31	4	3NO/1NC	Front	
UA-4-22	4	2NO/2NC	Front	
UA-4-13	4	1NO/3NC	Front	
UA-4-04	4	4NC	Front	

Frame Sizes 225AF - 800AF

Part No.	Poles	Configuration	Mounting	Contact Arrangement
AU-100-11	2	1NO/ 1NC	Side	



Installation Instructions

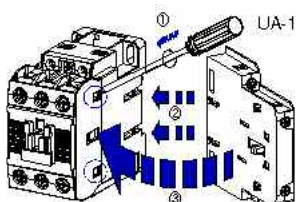

To install side mounting unit remove the indicated part in the circle in the fig. first. And then fit each part as shown. To separate push forward and pull.

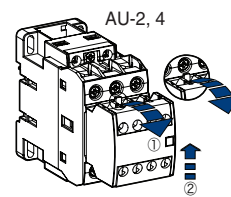

To install front mounting unit fit it on the upper part of the front of the contactor and push it down. To separate pull the lever of the unit and push the unit upward.



Surge Units (for use with frame sizes 22AF-100AF)

Part No.	Rated Voltage	Varistor	Internal Ratings Resistor	Capacitor
US-1	24-48VAC	120V	100 Ω	0.1 μF
US-2	100-125VAC	270V	100 Ω	0.1 μF
US-3	200-240VAC	470V	100 Ω	0.1 μF
US-4	24-48DC	120V	100 Ω	0.47 μF
US-5	100-125VDC	270V	100 Ω	0.47 μF
US-6	200-220VDC	470V	100 Ω	0.47 μF
US-11	24-48V AC/DC	120V	-	-
US-12	100-125V AC/DC	270V	-	-
US-13	200-240V AC/DC	470V	-	-
US-14	380-440V AC/DC	1000V	-	-
US-22	100-125VAC	-	56 Ω	0.1 μF

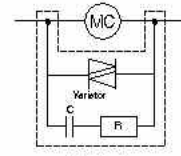

US-1~6

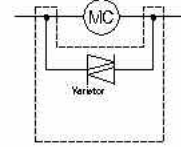

US-11~14

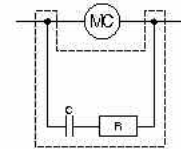

US-22



Terminal Covers

Part No.	Frame Size
AP-220	225AF
AP-400	400AF
AP-600	800AF



Insulation Barriers

Part No.	Frame Size
AI-180	225AF, 400AF
AI-600	800AF

Safety Cover*

Part No.
AP-9 (Fits all sizes)

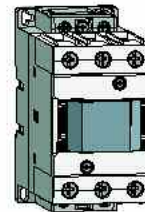

Bases for Separate Mounting Overload Relay

Part No.	Overload Relay
UZ-32	MT-32
UZ-63/S	MT-63
UZ-95/S	MT-95
UZ-150/S	MT-150A

Remote Reset Units for Overload Relay



Part No.	Cable Length (L)
UM-4R	400 mm
UM-5R	500 mm
UM-6R	600 mm

Dimensions Contactors

MC-9b~22b AC

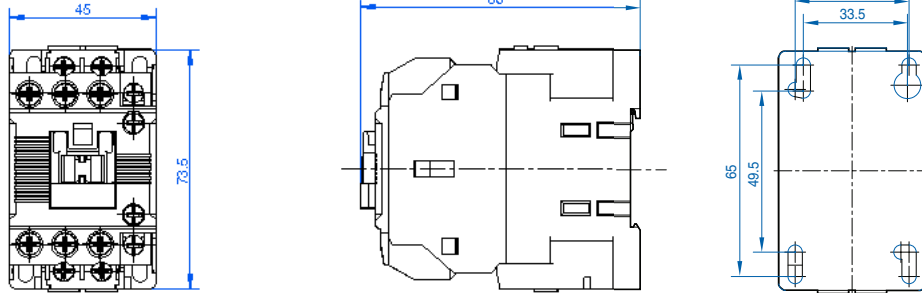

0.66 lb.

MC-9b~22b DC

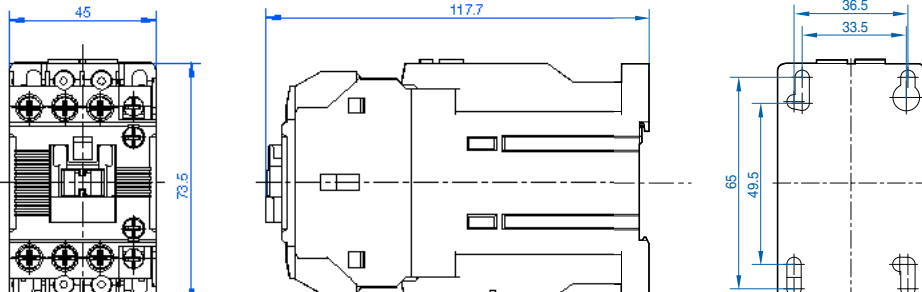

1.1 lb.

MC-32a~40a AC

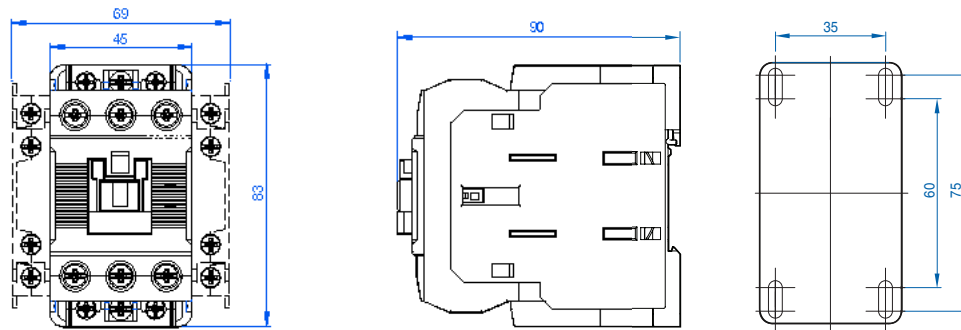

1.1 lb.

MC-32a~40a DC

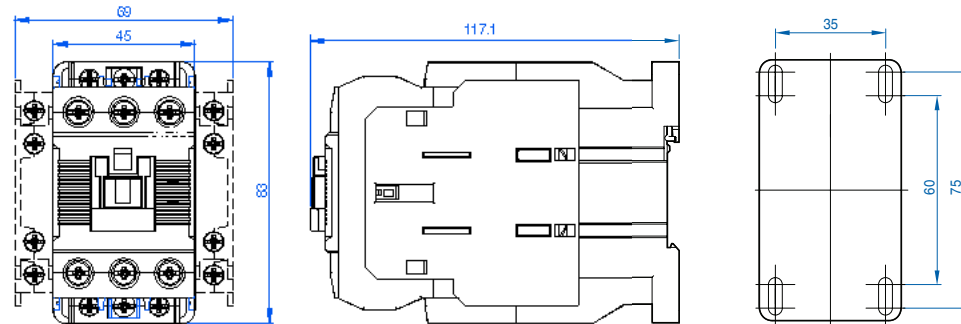

1.76 lb.

Dimensions in mm (to convert to inches multiply by 0.03937).

Dimensions Contactors

MC-130a
MC-150a

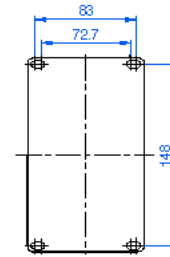
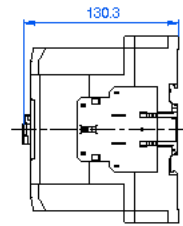
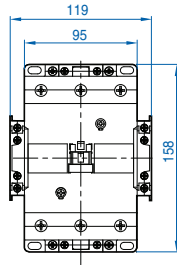

5.23 b.

MC-185a
MC-225a

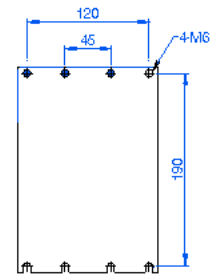
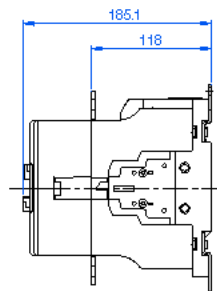
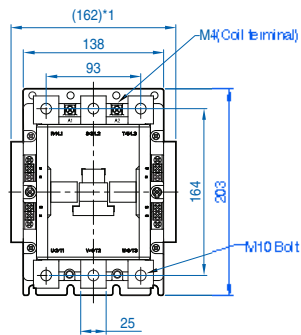

11.9 b.

MC-265a
MC-330a
MC-400a

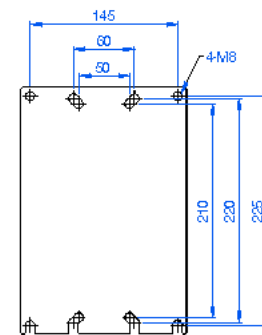
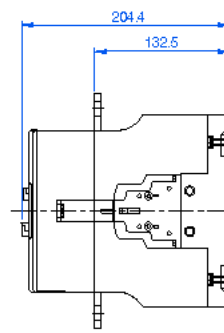
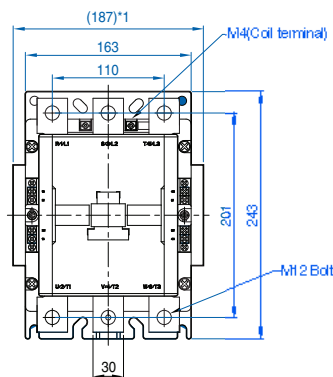

20.28 b.

MC-500a
MC-630a
MC-800a

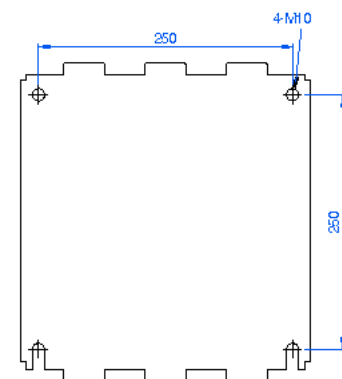
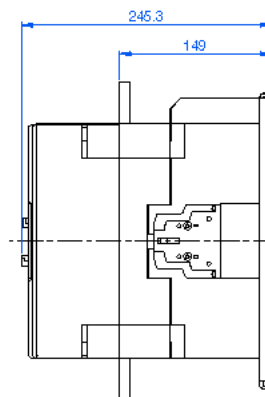
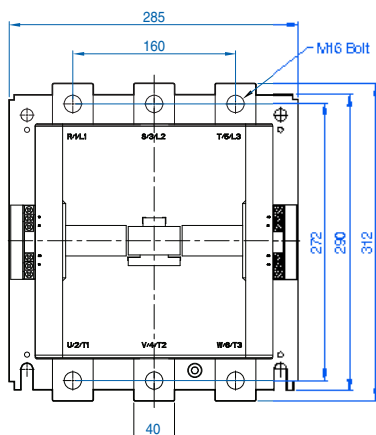

49.33 b.

Dimensions in mm (to convert to inches multiply by 0.03937).

Dimensions Overload Relays

MT-12

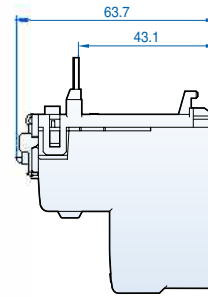
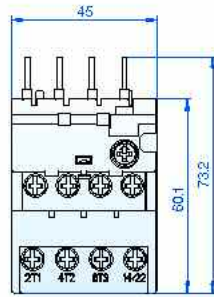

0.22 lb.

MT-32

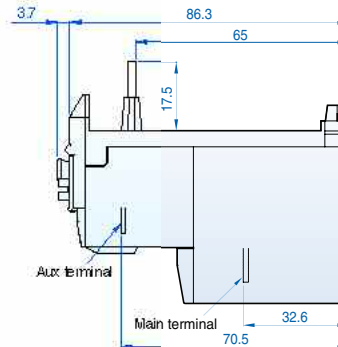
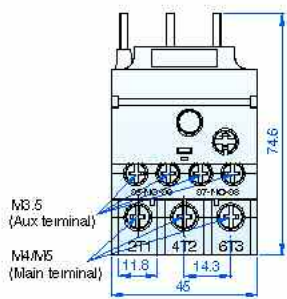

0.37 lb.

MT-63

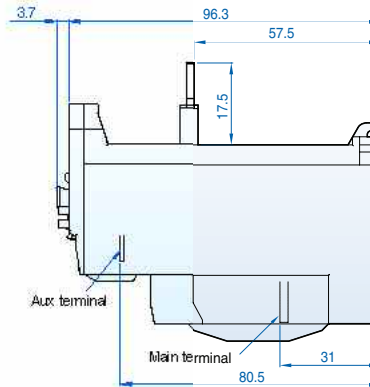
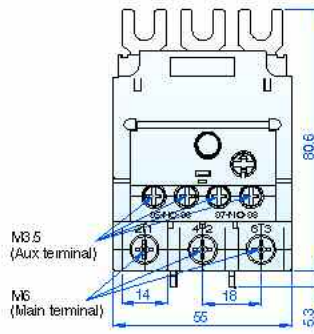

0.67 lb.

MT-95

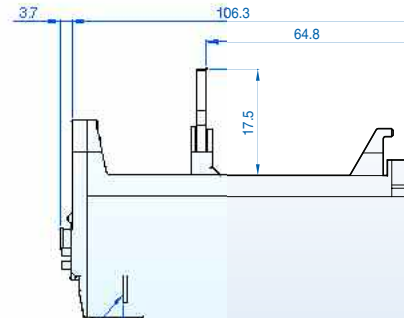
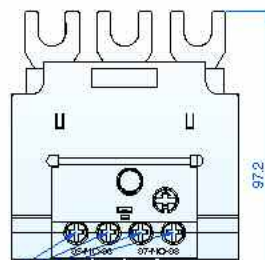

Dimensions in mm (to convert to inches multiply by 0.03937).

Dimensions Overload Relays

MT-150

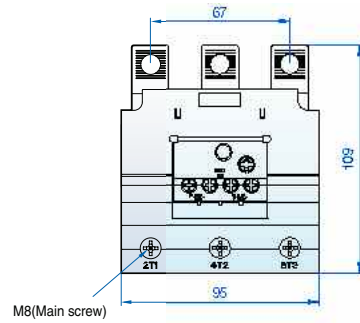

1.54 b.

MT-225

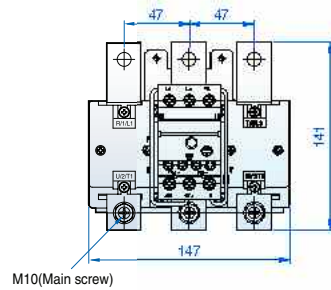

5.51 b.

MT-400

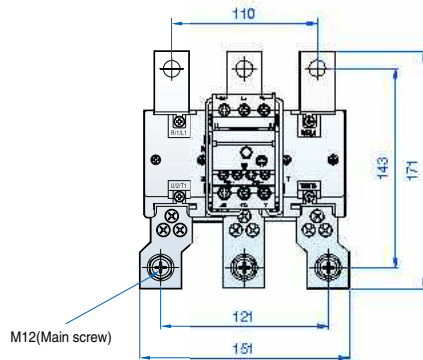

5.73 b.

MT-800

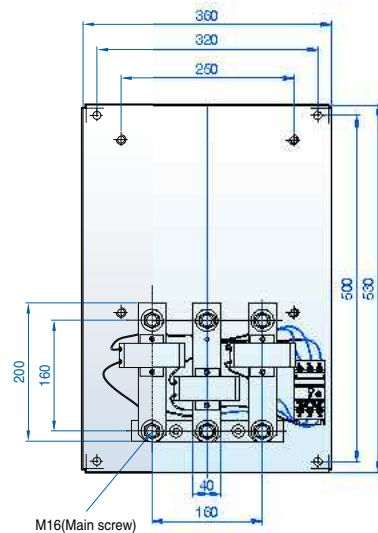

25.35 b.

Dimensions in mm (to convert to inches multiply by 0.03937).

IEC Ratings

MC Series

IEC Ratings (AC-1, AC-3) MC - Series

Type IEC60947-4 Ratings	MC-9B		MC-12B		MC-18B		MC-22B		MC-32A		MC-40A		MC-50A	
	kW	A	kW	A	kW	A	kW	A	kW	A	kW	A	kW	A
AC-1	-	25	-	25	-	32	-	40	-	50	-	60	-	70
AC-3 200/240V	2.5	11	3.5	13	4.5	18	5.5	22	7.5	32	11	40	15	55
380/440V	4	9	5.5	12	7.5	18	11	22	15	32	18.5	40	22	50
500/550V	4	7	7.5	12	7.5	13	15	20	18.5	28	22	32	30	43
690V	4	6	7.5	9	7.5	9	15	18	18.5	20	22	23	30	28

Type IEC60947-4 Ratings	MC-65A		MC-75A		MC-85A		MC-100A		MC-130A		MC-150A		MC-185A	
	kW	A	kW	A	kW	A	kW	A	kW	A	kW	A	kW	A
AC-1	-	100	-	110	-	135	-	160	-	160	-	210	-	230
AC-3 200/240V	18.5	65	22	75	25	85	30	105	37	130	45	150	55	185
380/440V	30	65	37	75	45	85	55	105	60	130	75	150	90	185
500/550V	33	60	37	64	45	75	55	85	60	90	70	100	110	180
690V	33	35	37	42	45	45	45	65	55	60	55	60	110	120

Type IEC60947-4 Ratings	MC-225A		MC-265A		MC-330A		MC-400A		MC-500A		MC-630A		MC-800A	
	kW	A	kW	A	kW	A	kW	A	kW	A	kW	A	kW	A
AC-1	-	275	-	300	-	350	-	450	-	580	-	660	-	900
AC-3 200/240V	75	225	80	265	90	330	125	400	147	500	190	630	220	800
380/440V	132	225	147	265	160	330	200	400	265	500	330	630	440	800
500/550V	132	200	147	225	160	280	225	350	265	400	330	500	500	720
690V	140	150	160	185	200	225	250	300	300	380	400	420	500	630

IEC RATINGS

We have a large line of Motor Protection Solutions

Circuit Protection Devices & Motor Disconnect Switches

Contact Altech Today!



Katko Motor Disconnect Switches



ABL UL508 Manual Motor Controllers,
UL489 Miniature Molded Case Circuit Breakers,
and UL1077 Supplementary Protectors



Altech's UL508 Manual Motor Controllers
UL489 Miniature Molded Case Circuit Breakers
and UL1077 Supplementary Protectors
PLUS

Molded Case Circuit Breakers, Three Phase
Adjustable Trip Miniature Circuit Breakers/Manual
Motor Controllers, Three Phase Adjustable Trip
Economy Manual Motor Controllers and Earth
Leakage Circuit Breakers

Mini Contactors



UL508
E108780



Mini Contactors

Type		6A	9A	12A
Number of Poles		3 NO main Contacts, 1 Auxiliary Contact		
Terminal Type		Screw Clamp	Screw Clamp	Screw Clamp
NEMA Size		00	00	00
Standard Auxiliary*		1NO	1NO	1NO
Coil Voltage Frequency		Part. No.	Part. No.	Part. No.
AC Coil	24V 50/60 Hz	GMC-6M-10-AC24V	GMC-9M-10-AC24V	GMC-12M-10-AC24V
	120V 50/60 Hz	GMC-6M-10-AC120V	GMC-9M-10-AC120V	GMC-12M-10-AC120V
	208V 60 Hz	GMC-6M-10-AC208V	GMC-9M-10-AC208V	GMC-12M-10-AC208V
	230V 50/60 Hz	GMC-6M-10-AC230V	GMC-9M-10-AC230V	GMC-12M-10-AC230V
Coil Characteristics and Data				
Pick-up Voltage Limit		80-110%		
Drop-out Voltage Limit		30-40%		
Coil Consumption (W)		2		
Inrush [VA]		32		
Holding [VA]		6		
Closing Time [ms]		10...20		
Opening Time [ms]		35...45		
DC Coil	12V -	GMD-6M-10-DC12V	GMD-9M-10-DC12V	GMD-12M-10-DC12V
	24V -	GMD-6M-10-DC24V	GMD-9M-10-DC24V	GMD-12M-10-DC24V
Coil Characteristics and Data				
Pick-up Voltage Limit		80-110%		
Drop-out Voltage Limit		10-30%		
Coil Consumption (W)		3		
Inrush [W]		3		
Holding [W]		3		
Closing Time [ms]		40-50		
Opening Time [ms]		35-45		
HP Rating / UL508		HP	HP	HP
Single phase	Continuous current	20A	20A	20A
	110~120V	0.5	0.5	1
Three phase	220~240V	1	1.5	2
	240V	1.5	3	3
	480V	3	5	7.5
	600	3	5	10
Overload Relays (Class 10A, Differential Typical)	Setting Ranges (A)		Frame Size 22AF	
	0.1-0.16A		GTK-12M-0.16	
	0.16-0.25A		GTK-12M-0.25	
	0.25-0.4A		GTK-12M-0.4	
	0.4-0.63A		GTK-12M-0.63	
	0.63-1A		GTK-12M-1	
	1-1.6A		GTK-12M-1.6	
	1.6-2.5A		GTK-12M-2.5	
	2.4-4A		GTK-12M-4	
	4-6A		GTK-12M-6	
	5-8A		GTK-12M-8	
	6-9A		GTK-12M-9	
	7-10A		GTK-12M-10	
9-13A		GTK-12M-13		
12-16A		GTK-12M-16		

Other AC Coil Voltages Available
50/ 60Hz:
42V, 48V,
110V, 220V,
277V, 400V,
480V, 600V

Other DC Coil Voltages Available
48V, 60V,
120V, 125V,
220V, 240V,
250V



* For built-in NC Auxiliary Switch change part number to -01; e.g. GMC-6M-01-AC24V.

Mini Contactors

Accessories

Reversing Mini Contactor

Separate parts for assembling Reversing Contactors

For Pre-assembled Reversing Mini Contactors please consult Altech.

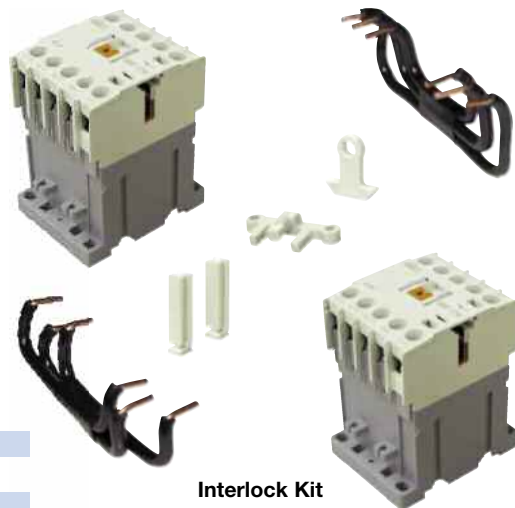

Interlock Kit

Interlock Kit

Part No.	Mini Contactor Type
AR-12M	6A - 12A

Auxiliary Contacts

Part No.	Poles	Configuration	Mounting
AU-1M-10	1	1NO	Side
AU-1M-01	1	1NC	Side
AU-2M-20	2	2NO	Front
AU-2M-02	2	2NC	Front
AU-2M-11	2	1NO/1NC	Front
AU-4M-40	4	4NO	Front
AU-4M-31	4	3NO/1NC	Front
AU-4M-22	4	2NO/2NC	Front
AU-4M-13	4	1NO/3NC	Front
AU-4M-04	4	4NC	Front

Surge Units

Part No.	Rated Voltage	Internal Element	Contactor Type
AS-12M/1	24-48VAC	Varistor	GMC-6M-12M
AS-12M/2	60-127VAC	Varistor	GMC-6M-12M
AS-12M/3	200-240VAC	Varistor	GMC-6M-12M
AS-12M/4	12-24VDC	Varistor	GMD-6M-12M
AS-12M/5	30-72VDC	Varistor	GMD-6M-12M
AS-12M/6	100-127VDC	Varistor	GMD-6M-12M
AS-12M/7	200-250VDC	Varistor	GMD-6M-12M

Base for Separate Mounting Overload Relay

Part No.
AZ-12MH

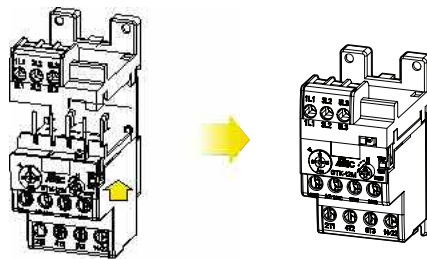

Specifications

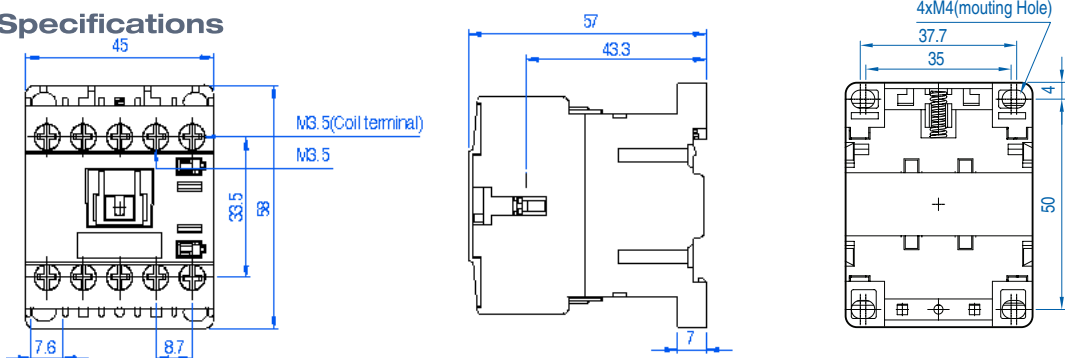

0.37 lb.

Dimensions in mm (to convert to inches multiply by 0.03937).

Manual Motor Starters

MMS Series

Altech Corp.[®]

**UL508
Type E**



Standards and Certifications

- UL508 (Manual Motor Controller)
- UL508 (Type E self-protected Manual Motor Controller)
- CSA C22.2 No.14
- IEC 60947-2 & IEC 60947-4-2

Features

- DIN Rail and Screw Mounting
- Lockable Handle in OFF position
- Finger safe terminals
- Class 10 thermal Overload protection
- Trip test feature
- Phase failure protection
- Adjustable thermal release
- Type F combination Manual Motor Controller (with MC-Series Contactor)
- Wide range of common accessories:
 - Auxiliary contacts
 - Alarm Switch
 - Undervoltage/ Shunt Trip
 - Rotary Handle
 - Busbar
 - MC-Series Mounting Adapter

General Specifications

Maximum Voltage	600V AC
Short Circuit Current Rating (SCCR)	up to 65kA@480VAC
Rated Frequency	50/60Hz
Max Operating Frequency	25 operations/hour
Operating Temperature	-20°C (-4°F) to +60°C (140°F)
Storage Temperature	-50°C (-58°F) to +80°C (176°F)
Degree of protection	IP20
Resistance to Shock	25g
Resistance to Vibration	5 - 150Hz

Terminal Size Acceptability and Torque

Wire Type	Conductors	MMS-32H	MMS-63H	MMS-100H
Solid	1	18-8 AWG	18-2AWG	12-2/0 AWG
	2	18-10AWG	18-4AWG	12-1/0 AWG
Stranded	1	18-10AWG	18-2AWG	12-2/0 AWG
	2	18-10AWG	18-4AWG	12-1/0 AWG
Flexible	1	18-10AWG	18-4AWG	12-2/0 AWG
	2	18-10AWG	18-6AWG	12-1/0 AWG
Torque		7-22 lb-in.	26-39 lb-in.	35-53 lb-in.



Manual Motor Starters

Manual Motor Starters

MMS Series



UL508 Type E
E252942



MMS-32H



MMS-63H



MMS-100H

Part No.	Rated Operational Current	Thermal Release Adjustment Range	Magnetic Release Operating Current	Horsepower Rating						Interrupting Capacity [kA]		
				Single Phase		Three Phase				240V	480V	600V
				115V	230V	200V	230V	460V	575V			
MMS-32H	MMS-32H-0.16A	0.16A	0.1...0.16A	2.1A	-	-	-	-	-	100	65	25
	MMS-32H-0.25A	0.25A	0.16...0.25A	3.3A	-	-	-	-	-	100	65	25
	MMS-32H-0.4A	0.4A	0.25...0.4A	5.2A	-	-	-	-	-	100	65	25
	MMS-32H-0.63A	0.63A	0.4...0.63A	8.2A	-	-	-	-	-	100	65	25
	MMS-32H-1.0A	1.0A	0.63...1.0A	13A	-	-	-	-	1/2	100	65	25
	MMS-32H-1.6A	1.6A	1.0...1.6A	20.8A	-	1/10	-	-	3/4 3/4	100	65	25
	MMS-32H-2.5A	2.5A	1.6...2.5A	32.5A	-	1/6	1/2	1/2	1 1 1/2	100	65	25
	MMS-32H-4.0A	4.0A	2.5...4.0A	52A	1/8	1/3	3/4	3/4	2 3	100	65	25
	MMS-32H-6A	6A	4...6A	78A	1/4	1/2	1	1 1/2	3 5	100	65	25
	MMS-32H-8A	8A	5...8A	104A	1/3	1	2	2	5 5	100	65	25
	MMS-32H-10A	10A	6...10A	130A	1/2	1 1/2	2	3	5 7 1/2	100	65	25
	MMS-32H-13A	13A	9...13A	169A	1/2	2	3	3	7 1/2 10	100	65	25
	MMS-32H-17A	17A	11...17A	221A	1	3	3	5	10 15	100	30	10
	MMS-32H-22A	22A	14...22A	286A	1 1/2	3	5	7 1/2	15 20	100	30	10
	MMS-32H-26A	26A	18...26A	338A	2	3	7 1/2	7 1/2	15 20	100	30	10
	MMS-32H-32A	32A	22...32A	416A	2	5	7 1/2	10	20 30	100	30	10
	MMS-32H-40A	40A	28...40A	520A	3	7 1/2	10	15	30 40	100	30	10
MMS-63H	MMS-63H-10A	10A	6...10A	130A	1/2	1 1/2	2	3	5 7 1/2	100	65	25
	MMS-63H-13A	13A	9...13A	169A	1/2	2	3	3	7 1/2 10	100	65	25
	MMS-63H-17A	17A	11...17A	221A	1	3	3	5	10 15	100	50	10
	MMS-63H-22A	22A	14...22A	286A	1 1/2	3	5	7 1/2	15 20	100	50	10
	MMS-63H-26A	26A	18...26A	338A	2	3	7 1/2	7 1/2	15 20	100	50	10
	MMS-63H-32A	32A	22...32A	416A	2	5	7 1/2	10	20 30	100	50	10
	MMS-63H-40A	40A	28...40A	520A	3	7 1/2	10	10	30 30	100	50	10
	MMS-63H-50A	50A	34...50A	650A	3	10	15	15	30 40	100	50	10
	MMS-63H-63A	63A	45...63A	819A	5	10	20	20	40 60	100	50	10
	MMS-63H-65A	65A	47...65A	845A	5	15	20	25	50 60	100	50	10
MMS-100H	MMS-100H-17A	17A	11...17A	221A	1	3	3	5	10 15	100	65	25
	MMS-100H-22A	22A	14...22A	286A	1 1/2	3	5	7 1/2	15 20	100	65	25
	MMS-100H-26A	26A	18...26A	338A	2	3	7 1/2	7 1/2	15 20	100	65	25
	MMS-100H-32A	32A	22...32A	416A	2	5	7 1/2	10	20 30	100	65	20
	MMS-100H-40A	40A	28...40A	520A	3	7 1/2	10	10	30 30	100	65	20
	MMS-100H-50A	50A	34...50A	650A	3	10	15	15	30 40	100	65	20
	MMS-100H-63A	63A	45...63A	819A	5	10	20	20	40 60	100	50	10
	MMS-100H-75A	75A	55...75A	975A	5	15	20	25	50 60	100	50	10
	MMS-100H-90A	90A	70...90A	1170A	7 1/2	20	25	30	60 75	100	50	10
	MMS-100H-100A	100A	80...100A	1300A	10	20	30	30	75 100	100	50	10

Drawings and other technical information can be found on page 24-25.

Accessories

Manual Motor Starter
- MMS Series



Altech Corp.®

FX...

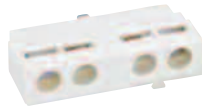

Auxiliary Contacts

Part No.	Poles	Configuration	Mounting
FX-20	2	2NO	Front
FX-11	2	1NO/1NC	Front
FX-02	2	2NC	Front
LX-20	2	2NO	Side
LX-11	2	1NO/1NC	Side
LX-02	2	2NC	Side

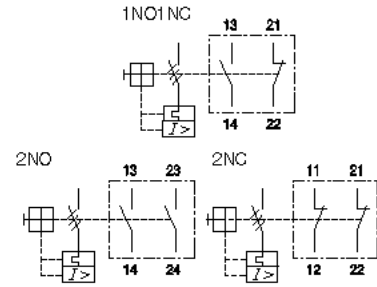

Connection Diagrams FX

LAM...



Alarm Contacts

Part No.	Poles	Configuration	Mounting
LA-20	Any Trip	2NO	Side
LA-11	Any Trip	1NO/1NC	Side
LA-02	Any Trip	2NC	Side
LAM-20	Magnetic Trip	2NO	Side
LAM-11	Magnetic Trip	1NO/1NC	Side
LAM-02	Magnetic Trip	2NC	Side

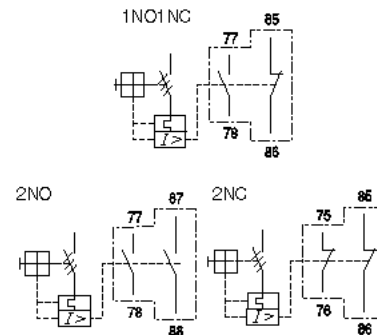

Connection Diagrams LAM

RS...



Shunt Trips*

Part No.	Control Voltage	
	50 Hz	60Hz
RS-28V	24VAC	28VAC
RS-120V	110VAC	120VAC
RS-220V	200VAC	200-220VAC
RS-260V	220-230VAC	240-260VAC
RS-277V	240VAC	277VAC
RS-440V	380-400VAC	440-460VAC
RS-480V	415-440VAC	460-480VAC

*cannot be used with RU or RUX

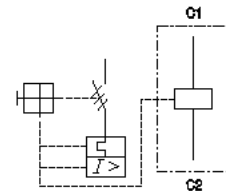

Connection Diagrams RS

RU...



Undervoltage Trips**

Part No.	Control Voltage	
	50 Hz	60Hz
RU-28V	24VAC	28VAC
RU-120V	110VAC	120VAC
RU-220V	200VAC	200-220VAC
RU-260V	220-230VAC	240-260VAC
RU-277V	240VAC	277VAC
RU-440V	380-400VAC	440-460VAC
RU-480V	415-440VAC	460-480VAC

**cannot be used with RS or RUX

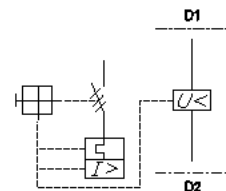

Connection Diagrams RU

RUX...



Undervoltage Trips with Switches*** includes 2NO Auxiliary Contacts

Part No.	Control Voltage	
	50 Hz	60Hz
RUX-28V	24VAC	28VAC
RUX-120V	110VAC	120VAC
RUX-220V	200VAC	200-220VAC
RUX-260V	220-230VAC	240-260VAC
RUX-277V	240VAC	277VAC
RUX-440V	380-400VAC	440-460VAC
RUX-480V	415-440VAC	460-480VAC

***cannot be used with RS or RU

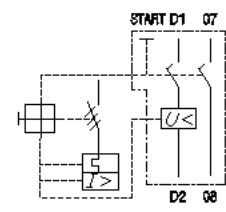

Connection Diagrams RUX

Manual Motor Starters

Accessories

Manual Motor Starter
- MMS Series



UL508 Type E
E252942

Manual Motor Starters

Extended Handles

- Lockable in ON/ OFF position
- IP65 protection



Part No.	MMS-Type	Shaft Length
MEH-32-115	MMS-32H	115mm (4.53in.)
MEH-32-315	MMS-32H	315mm (12.4in.)
MEH-63-115	MMS-63H	115mm (4.53in.)
MEH-63-315	MMS-63H	315mm (12.4in.)
MEH-100-115	MMS-100H	115mm (4.53in.)
MEH-100-315	MMS-100H	315mm (12.4in.)

Busbars



Part No.	MMS Type	No, MMS	Rated Current
PB-322	MMS-32H	2	63A
PB-323	MMS-32H	3	63A
PB-632	MMS-63H	2	108A
PB-633	MMS-63H	3	108A

Insulation Cap

Part No.	Busbar Type
PBPC-32	PB-32x
PBPC-63	PB-63x



Insulated Enclosure

- IP65 protection

Part No.	MMS Type
EPH-32	MKMS-32H



Dial Cover

Dial Cover

to protect set value from unintended operation (for all types)

Part No.
DIAL COVER

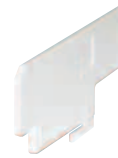

Insulation Barrier

to increase creepage and clearance distance (for MMS-100H only)

Part No.
IB100

Direct Adapters and Mounting Units

- Connect MMS directly with Metasol or Mini Contactor
- Type F combination Motor Controllers consisting of Type E MMS device with MC Series contactor

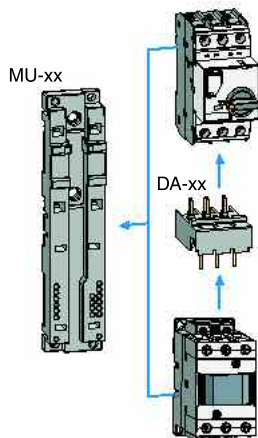

Part No.	MMS Type	Combined Contactor Type	Mounting Unit
DA-16HA	MMS-32H	Mini Contactor GMC-6M...12M AC	MU-45
DA-16HD	MMS-32H	Mini Contactor GMC-6M...12M AC	MU-45
DA-22HA	MMS-32H	MC-9B...22B AC	MU-45
DA-22HD	MMS-32H	MC-9B...22B DC	MU-45
DA-32HA	MMS-32H	MC-32A...40A AC	MU-45
DA-32HD	MMS-32H	MC-32A...40A DC	MU-45
DA-63A	MMS-63H	MC-50A...65A AC	MU-55
DA-63D	MMS-63H	MC-50A...65A DC	MU-55
DA-95A	MMS-100H	MC-75A...100A AC	MU-70
DA-95D	MMS-100H	MC-75A...100A DC	MU-70

Trip Curves

MMS-32H

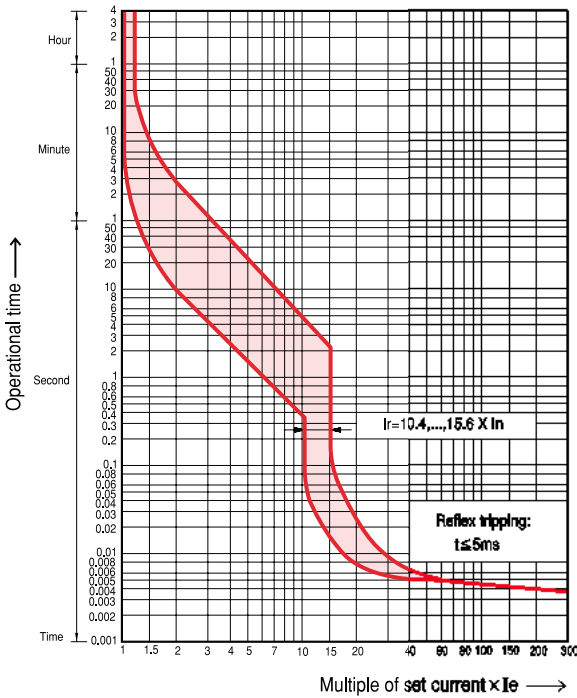

MMS-63H, MMS-100H

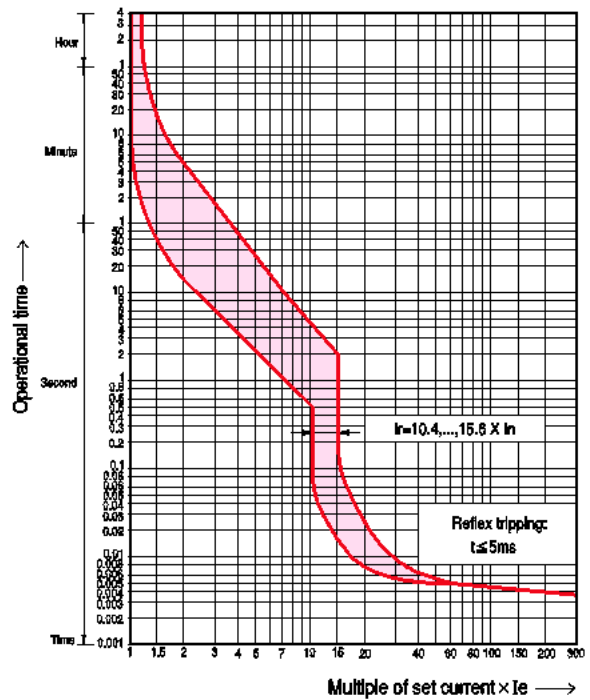

Thermal Short Circuit Limit

MMS-32H

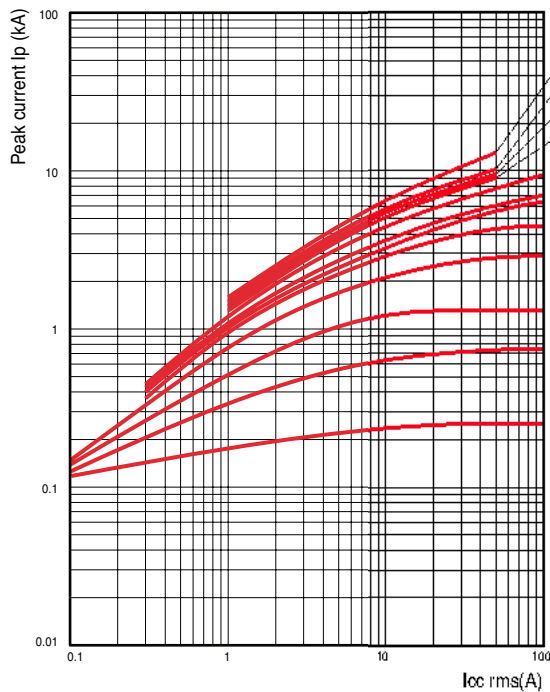

MMS-63H

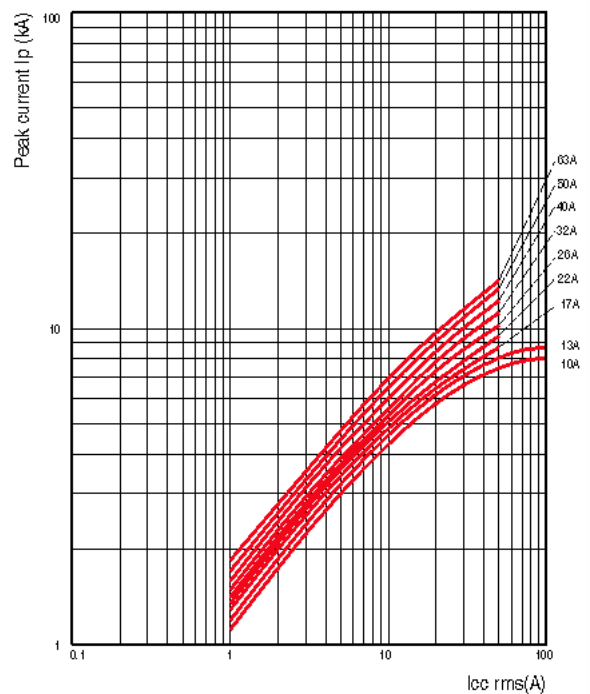

Specifications

MMS Series

- 1) Side auxiliary switch
- 2) Side magnetic trip alarm switch
- 3) Side shunt release or Side undervoltage release
- 4) Front auxiliary switch
- 5) Handle lock in OFF position (Ø 5mm)
- 6) Push-in Lugs for screw mounting
- 7) 35mm standard mounting rail acc. to EN 50 022

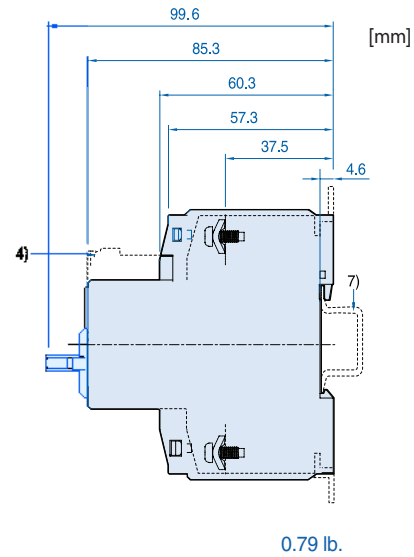
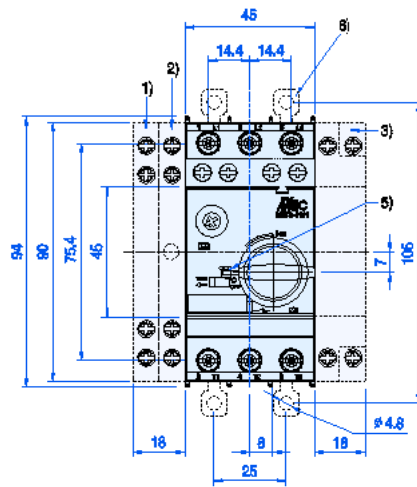

- 1) Side auxiliary switch
- 2) Side magnetic trip alarm switch
- 3) Side shunt release or Side undervoltage release
- 4) Front auxiliary switch
- 5) Handle lock in OFF position (Ø 5mm)
- 6) 35mm standard mounting rail acc. to EN 50 022

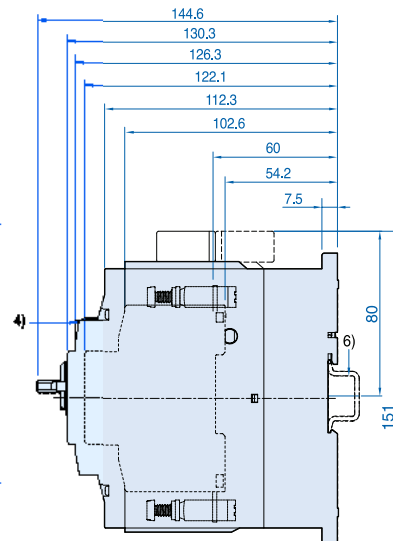
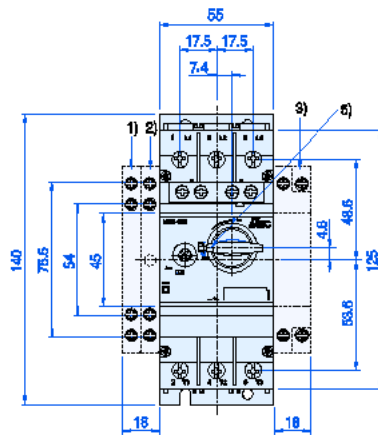

- 1) Side auxiliary switch
- 2) Side magnetic trip alarm switch
- 3) Side shunt release or Side undervoltage release
- 4) Front auxiliary switch
- 5) Handle lock in OFF position (Ø 5mm)
- 6) 35mm standard mounting rail acc. to EN 50 022
- 7) 75mm standard mounting rail acc. to EN 50 023
- 8) 4mm hexagon socketscrew

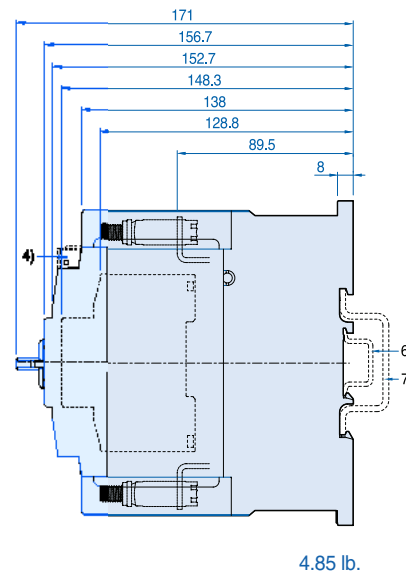
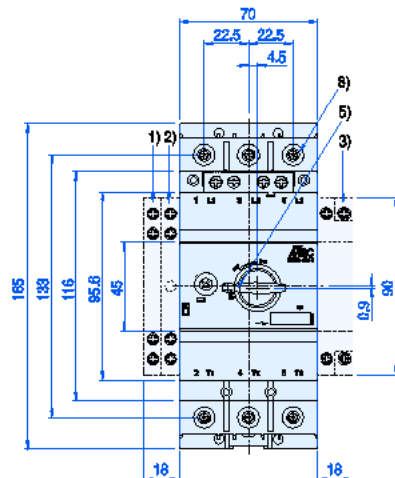

Dimensions in mm (to convert to inches multiply by 0.03937).

TITLE - Title to the products of ALTECH shall remain with ALTECH until payment is made in full by Customer. Such reservation of title is for the purpose of securing the purchase price and shall not relieve Customer of the duty to inspect the products upon receipt, to notify ALTECH of any deficiencies or defects, and to exercise due care in the use, installation, operation, and maintenance of the products when on the premise of the Customer or under the control of the Customer. Notwithstanding any reservation of title by ALTECH, risk of loss shall pass to customer at any time of shipment.

SHIPMENT AND DELIVERY - All orders for destination in the mainland United States (less Hawaii, Alaska and non-continental United States possessions) will be shipped F.O.B. Flemington, N.J. All destination, shipping and other charges shall be paid by the Customer in accordance with ALTECH's then current shipping and billing practices.

Delivery dates given in the acceptance of any order are approximate. ALTECH shall not be liable for delays in delivery or in performance due to causes beyond its reasonable control including acts of God, acts of Customer, acts of civil or military authority, fires, strikes or other labor disturbances, war, riot or delays in transportation. In the event of such delay, the date of delivery or performance shall be extended for a period equal to the time lost by reason of the delay.

PRICE - PRICES in any ALTECH publication are subject to change without prior notification. Catalog prices are based on prices published in the current price list. All written quotations are valid for thirty (30) days from the date of quotation. Customer shall pay all sales, use, excise or similar taxes whenever ALTECH must itself pay and/or collect such tax from Customer arising out of the sale.

PAYMENT - Customer agrees to make payment within thirty (30) days of date of the invoice from ALTECH. Customer agrees to pay a late payment charge of one and one-half percent (1.5% per month, or the maximum late payment charge permitted by applicable law, whichever is less, on any unpaid amount for each calendar month (or fraction thereof) that such payment is in default. Orders amounting to less than \$100.00 will be billed at \$100.00 plus freight. Full carton purchases are required. In the event of referral to an attorney for collection, reasonable attorney's fees for collection of the overdue amount shall be paid by Customer. In the event payment is not received within 30 days from the date of invoice, any discount shall be cancelled and the full list price will be due.

LIMITED WARRANTY - ALTECH warrants to Customer that the equipment purchases shall be free from defects in material and workmanship under normal use and service for a period of one year from shipment.

Written notice as an explanation of the circumstances of any claim that the equipment has proved defective in material or workmanship shall be given promptly by the Customer to ALTECH.

ALTECH will not be liable for any misuse, improper operations, improper installation, improper maintenance, alteration, modification, accident or unusual degradation of the equipment or parts due to an unsuitable installation environment.

No representation of other affirmation of facts, including but not limited to statements regarding capacity, suitability for use or performance of the equipment, shall be or be deemed to be a warranty or representation by ALTECH for any purpose, nor give rise to any liability or obligation of ALTECH whatsoever.

Customer's sole and exclusive remedy in the event of breach of warranty, as set forth herein, is expressly limited to (1) the correction of the defect by adjustment, repair, modification, or replacement, or (2) issuance of a credit or refund of the purchase price for the defective equipment at ALTECH's election and sole expense.

EXCEPT AS SPECIFICALLY PROVIDED IN THIS AGREEMENT, THERE ARE NO OTHER WARRANTIES EXPRESSED OR IMPLIED INCLUDING BUT NOT LIMITED TO ANY IMPLIED WARRANTIES OR MERCHANTABILITY OR FITNESS FOR A PARTICULAR PURPOSE.

THIS WARRANTY EXTENDS ONLY TO THE CUSTOMER FROM ALTECH OR ITS AUTHORIZED DISTRIBUTOR.

LIMITATION OF LIABILITY - IN NO EVENT, SHALL ALTECH BE LIABLE FOR LOSS OF PROFITS, INDIRECT, SPECIAL, CONSEQUENTIAL OR OTHER SIMILAR DAMAGES ARISING OUT OF ANY BREACH OF THIS AGREEMENT OR OBLIGATIONS UNDER THE AGREEMENT.

ALTECH SHALL NOT BE LIABLE FOR ANY DAMAGES CAUSED BY DELAY IN SHIPMENT, INSTALLATION OR FURNISHING OF EQUIPMENT OR SERVICES UNDER THIS AGREEMENT.

No action arising out of any claimed breach of this Agreement may be brought by either party more than two (2) years after the cause of action has accrued.

PATENT INDEMNITY - ALTECH shall defend or settle any suit or proceeding brought against Customer based on a claim that any equipment made to ALTECH design and furnished hereunder constitutes an infringement of any existing United States patent, provided (ALTECH) is notified promptly in writing and is given complete authorization and information required for the defense, and ALTECH shall pay all damages and costs awarded against Customer, but shall not be responsible for any costs, expense or compromise incurred or made by Customer without ALTECH's prior written consent. If any equipment is in ALTECH's opinion likely to or does become the subject of a claim for patent infringement, ALTECH may at its option and expense procure for Customer the right to continue using the device, modify it to become non-infringing, but in the event ALTECH is not reasonably able to modify, substitute, or otherwise procure for Customer the right to continue using it, ALTECH will remove such equipment and refund to Customer the amount paid in excess of a reasonable rental for past use.

ALTECH shall not be liable for any infringement or claim based upon use of the equipment in combination with other equipment not supplied by ALTECH or with modifications made by Customer.

The foregoing states the entire liability of ALTECH to Customer arising from patent infringement.

SELLER'S REMEDIES - Should Customer fail to make any payment within ten (10) days of its due date, or fail to perform any other of the Customer's obligation hereunder upon thirty (30) days written notice, or should Customer be or become insolvent or be a party to any bankruptcy receivership proceeding prior to full payment of all amounts payable hereunder, ALTECH may: (a) with or without demand or notice to customer declare the entire amount unpaid immediately due and payable; (b) enter upon the premises where the equipment may be found and remove it (Customer shall assemble the equipment and make it available to ALTECH at a place reasonably convenient to both parties and shall permit and assist ALTECH in effecting the retaking and removal of the equipment); and (c) sell any or all the equipment as permitted under applicable law, applying the proceeds of the sale to payment of the expenses of retaking, repairing and selling the equipment, reasonable attorney fees and to the satisfaction of all indebtedness then due and unpaid under this Agreement. Any surplus shall be paid to Customer and any deficiency shall be paid to ALTECH by Customer.

The remedies provided herein shall be cumulative and in addition to all other remedies provided by law or equity or under the Uniform Commercial Code.

GOVERNING LAW - This agreement will be governed by the Laws of the State of New Jersey.

GENERAL - This Agreement shall only become effective and binding when either (a) it has been accepted and executed by an authorized representative of ALTECH, or (b) the equipment has been shipped to Customer, with or without acceptance in writing hereon. Notice of acceptance is hereby waived by Customer. Customer hereby acknowledges receipt of a true and complete copy hereof.

No addition to or modification of any of the Terms and Conditions of Sale as they appear herein shall be binding upon ALTECH unless signed in writing by duly authorized representative of ALTECH in Flemington, N.J.

Typographical and clerical errors in quotations, orders and acknowledgments are subject to correction.

This Agreement is not assignable without the prior written consent of ALTECH. Any attempt to assign any of the rights, duties or obligations of this Agreement without such consent is void.

If any provision or provisions of this Agreement shall be held to be invalid, illegal or unenforceable, the validity, legality and enforceability, of the remaining provisions shall not in any way be affected or impaired thereby.

ALTECH is not responsible for failure to fulfill its obligation under this Agreement due to causes beyond its control, or except as agreed herein.

THE CUSTOMER ACKNOWLEDGES THAT HE HAS READ THE AGREEMENT, UNDERSTANDS IT, AND AGREES TO BE BOUND BY ITS TERMS AND CONDITIONS. FURTHERMORE, THE CUSTOMER AGREES THAT IT IS THE COMPLETE AND EXCLUSIVE STATEMENT OF THE AGREEMENT BETWEEN THE PARTIES, WHICH SUPERSEDES ALL PROPOSALS OR PRIOR AGREEMENTS, ORAL OR WRITTEN, EXPRESSED OR IMPLIED, AND ALL OTHER COMMUNICATIONS BETWEEN THE PARTIES RELATING TO THE SUBJECT MATTER OF THIS AGREEMENT.



Altech Search

- Home
- Stock Check
- Distributors
- Information
- News
- Contact
- Rep/Dist Login
- Altech Mexico

- WEB TOOLS
 - Altech Videos
 - Product Crossings
 - Request for Quote
 - Sample Request
 - Catalog Request
 - eBook Catalog
- PRODUCT MENU
 - ATEX Products
 - Circuit Protection / Control
 - Connectors
 - Enclosures
 - European Spare Parts
 - Digital Panel Meters
 - Foot Switches
 - Interface Modules
 - Panel Accessories
 - Power Supplies
 - Power Semi-Conductors
 - Programmable Controllers
 - Push Buttons & Pilot Lights
 - Relays
 - Sensors
 - Safety Switches & Enclosures
 - Solid State Relays
 - Terminal Blocks
 - Test & Measurement
 - Tower Lights
 - Trainers

New Products and Promotions

AS SHORT AS **2** Week Turn Around

CUSTOM ASSEMBLY and Valued Added Services

- Imprinting
- Relay Modules
- Light Assemblies
- Interface Modules
- Component Carrier Modules
- Foot Switch Assemblies
- DIN Rail Assemblies
- Enclosure Milling

Click for your local
ALTECH REPRESENTATIVE

**Serving the Automation & Control Industry
Since 1984**

CIRCUIT PROTECTION

- Circuit Protection Devices
- Busbar & Power Distribution
- Contactors, Overload Relays, Manual Motor Starters
- Motor Disconnect Switches
- European Fuses & Holders

CONNECTORS

- Pin & Sleeve Devices
- Receptacles
- Industrial Rectangular Connectors

ENCLOSURES

- Industrial & ATEX Enclosures
- DIN Enclosures

FOOT SWITCHES

- Industrial
- Medical

MODULES & RELAYS

- Interface Modules
- Safety Relays
- Industrial & Slimline Relays

Altech Corporation
35 Royal Road
Flemington, NJ 08822-6000
P 908.806.9400 • F 908.806.9490
www.altechcorp.com

Altech Corp.® 901FULLN
ONLINE

X-ON Electronics

Largest Supplier of Electrical and Electronic Components

Click to view similar products for [Contactors - Electromechanical category](#):

Click to view products by [Altech manufacturer](#):

Other Similar products are found below :

[6-1618400-7](#) [686-117111](#) [686-120111](#) [686-924](#) [686-948](#) [70-901](#) [70-914](#) [MB-3D-6](#) [MC-22A/4-AC120V](#) [8-1616943-9](#) [A40-30-10-84](#) [120-905](#) [A701U](#) [120-904](#) [1393132-9](#) [154-905](#) [154-912](#) [154-913](#) [154-915](#) [154-902](#) [154-910](#) [B6-40-00-84](#) [B7-40-00-84](#) [1616017-5](#) [1616021-1](#) [1616039-1](#) [MVDILM](#) [P25-E5019-1](#) [P30C47A12D1-120](#) [P40C47A12D1-120](#) [P40P47D13P1-24-01](#) [CA7-12-10-240](#) [90-162](#) [9-1393132-2](#) [2NC4F0222](#) [A275KXXV2-120VAC](#) [ACC338UMM20](#) [AF80-30-11-13](#) [SZ-B1](#) [CGC-9A-120](#) [3GC2H0M22](#) [3NC0T0A22](#) [3NC1Q0A22](#) [3NC2H0A22](#) [3NC2T0122/SE](#) [3TF3400-0BB4](#) [MC-12B-DC24V](#) [42AF35AG](#) [42AF35AH](#) [42CF35AE](#)