

GFR Series - 1 Pole+N, B Trip, 10 mA 277V AC Ground Fault Relay with Overload Protection (RCBO)

The GFR Series is a combined Equipment Ground Fault Relay and Supplementary Protector (RCBO), featuring dual pole switching (live and neutral) and designed to provide protection against overloads and AC ground faults (residual current faults) as well as pulsating DC ground faults.



Ordering Information

Rated Current	Type/ Cat. No.	Rated Voltage
5.0A	GFR2B05010	277V AC
6.0A	GFR2B06010	277V AC
8.0A	GFR2B08010	277V AC
10A	GFR2B10010	277V AC
12A	GFR2B12010	277V AC
13A	GFR2B13010	277V AC
15A	GFR2B15010	277V AC
16A	GFR2B16010	277V AC
20A	GFR2B20010	277V AC
25A	GFR2B25010	277V AC

Technical Specification

Number of Poles	1+N
Voltage Rating (maximum)	277V AC
Ground Fault Sensitivity Level	10 mA
Short Circuit Withstand Rating	30 kA
Rated Frequency	50/60Hz
Trip Characteristic	B
Cable Size & Tightening Torque	Stranded Wire: 16 - 3 AWG (1.5 mm ² - 25 mm ²) @ 17.5 lb-in (2.0 Nm) Solid Wire: 16 - 10 AWG (1.5 mm ² - 5.5 mm ²) @ 17.5 lb-in (2.0 Nm) 18 - 16 AWG (1 mm ² - 1.5 mm ²) @ 25 lb-in (2.8 Nm)
Electrical Life	6000 Switching Operations
Mechanical Life	10000 Switching Operations

Dimensions

(to convert to inches multiply by 0.03937)

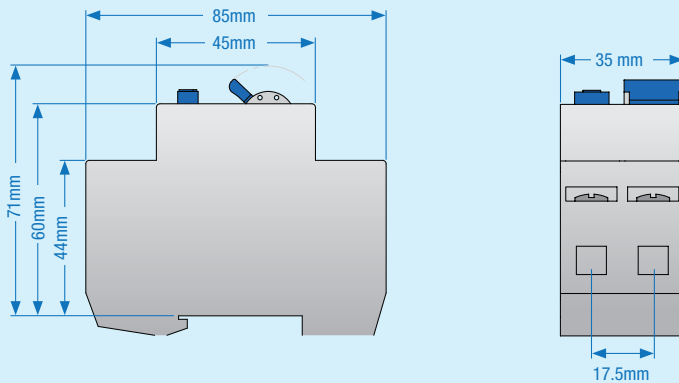

Weight

217 g

GFR Series RCBO Short Circuit Withstand Rating

V	I	IR	Backup
1+N Pole	≤20A	10kA	None
277V AC	>20A	10kA	Class J Fuse 250A or lower Altech L Series Branch Circuit Breaker Altech R Series Supplementary Protector

GFR Series RCBO Overload Trip Curves

Characteristics B, C, D

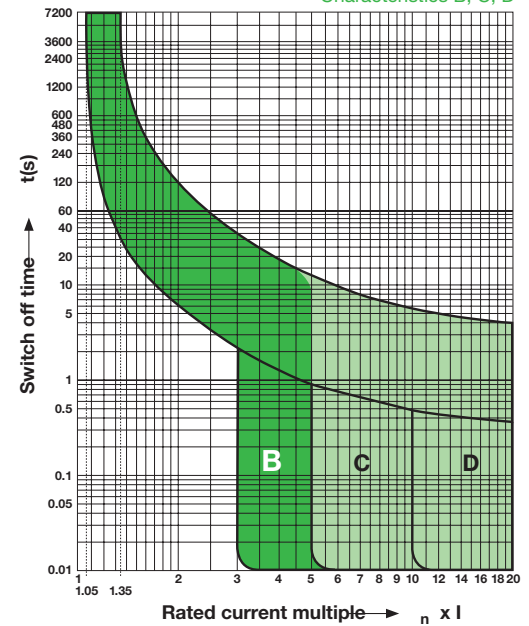

GFR Series RCBO Ground Fault Trip Curve

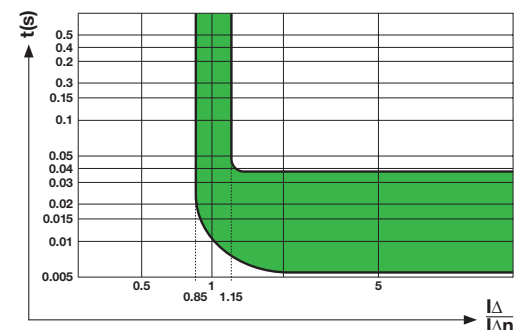

UL 1077
Ground Fault Relay
with Overload Protection

GFR Series - 1 Pole+N, B Trip, 10 mA
 Applicable voltage systems and wiring examples.

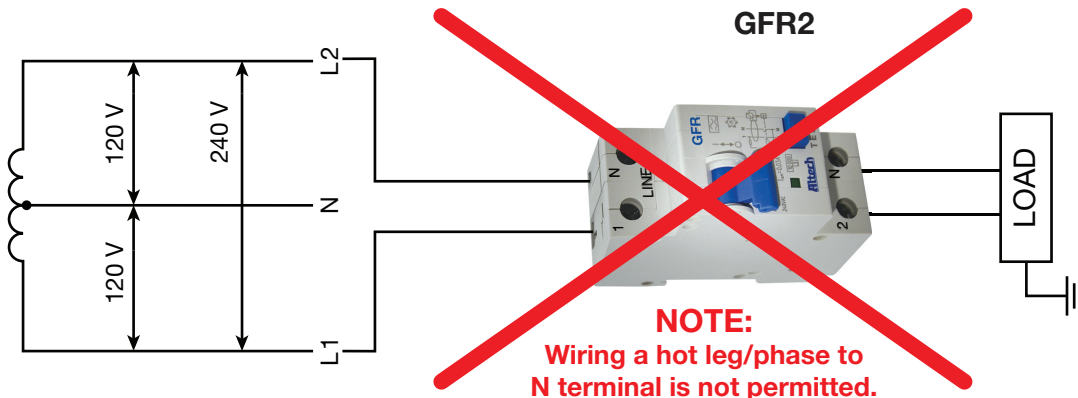
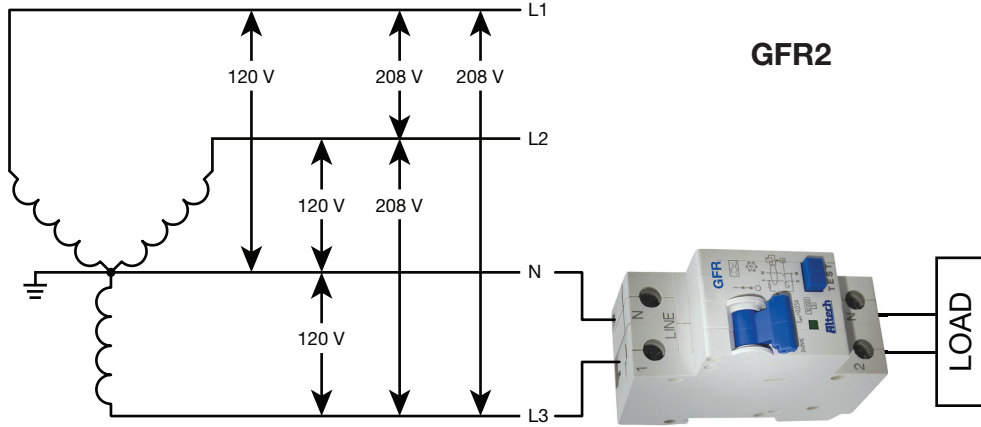
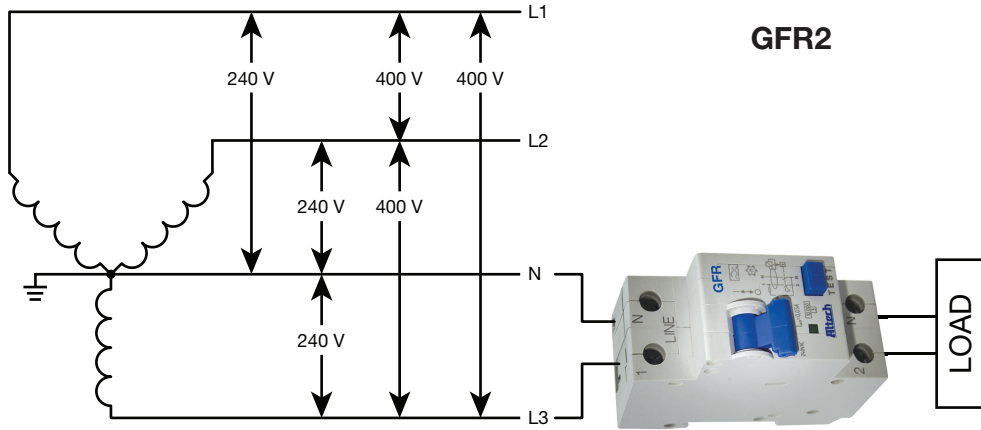
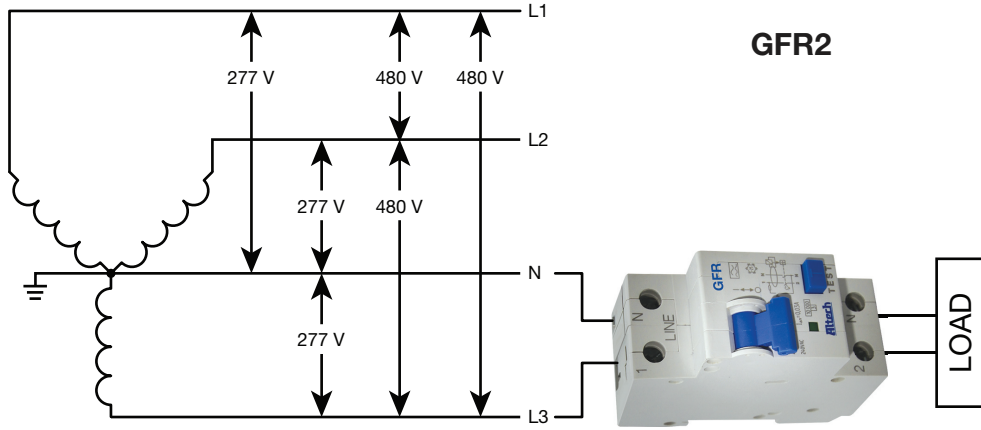

UL 1077
 Ground Fault Relay
 with Overload Protection

X-ON Electronics

Largest Supplier of Electrical and Electronic Components

Click to view similar products for [Circuit Breaker Accessories](#) category:

Click to view products by [Altech](#) manufacturer:

Other Similar products are found below :

[CSC-403PS](#) [8T1-D-11A](#) [B151-7184-L](#) [NEB10](#) [8C1-C-721](#) [8T1-E-115](#) [8T1-E-275](#) [8T1-E-278](#) [506-11315-001](#) [3803221](#) [X10506BF](#) [NES 9-](#)
[1393249-0](#) [802-ESB50UL489](#) [XFPB-4](#) [30.329](#) [X22261102](#) [CX2.5/4/O](#) [Y30019003](#) [PS-1006](#) [618.6335.069](#) [BAC03](#) [JX2.5/4](#) [JX2.5/6](#)
[JX2.5/5](#) [HSP6/10U](#) [DMRBU BLACK BOX](#) [DB16/BU](#) [CM2.5S2](#) [932146100](#) [930120000](#) [601.1231.909](#) [3PRG1](#) [3PLBR4LU](#) [351.5900.149](#)
[311.2850.340](#) [2624.0](#) [17BSSV](#) [1-1423696-8](#) [LS3-WH](#) [BAC12](#) [Y30028402](#) [30.617](#) [8T1-E-114](#) [SF06-5,08](#) [2LP199](#) [ZG20-2](#) [3PSML401](#)
[3PSML402](#) [2LP219](#)