

# GFR Series - 1 Pole+N, D Trip, 100 mA 480Y/277V AC Ground Fault Relay with Overload Protection (RCBO)

The GFR Series is a combined Equipment Ground Fault Relay and Supplementary Protector (RCBO), featuring dual pole switching (live and neutral) and designed to provide protection against overloads and AC ground faults (residual current faults) as well as pulsating DC ground faults.



## Ordering Information

Rated Current	Type/ Cat. No.	Rated Voltage
5.0A	GFR2D05100	480Y/277V AC
6.0A	GFR2D06100	480Y/277V AC
8.0A	GFR2D08100	480Y/277V AC
10A	GFR2D10100	480Y/277V AC
12A	GFR2D12100	480Y/277V AC
13A	GFR2D13100	480Y/277V AC
15A	GFR2D15100	480Y/277V AC
16A	GFR2D16100	480Y/277V AC
20A	GFR2D20100	480Y/277V AC
25A	GFR2D25100	480Y/277V AC
30A	GFR2D30100	480Y/277V AC
32A	GFR2D32100	480Y/277V AC
35A	GFR2D35100	480Y/277V AC
40A	GFR2D40100	480Y/277V AC

**UL 1077**  
Ground Fault Relay  
with Overload Protection

## Technical Specification

Number of Poles	1+N
Voltage Rating (maximum)	480Y/277V AC
Ground Fault Sensitivity Level	100 mA
Short Circuit Withstand Rating	30 kA
Rated Frequency	50/60Hz
Trip Characteristic	D
Cable Size & Tightening Torque	Stranded Wire: 16 - 3 AWG (1.5 mm <sup>2</sup> - 25 mm <sup>2</sup> ) @ 17.5 lb-in (2.0 Nm) Solid Wire: 16 - 10 AWG (1.5 mm <sup>2</sup> - 5.5 mm <sup>2</sup> ) @ 17.5 lb-in (2.0 Nm) 18 - 16 AWG (1 mm <sup>2</sup> - 1.5 mm <sup>2</sup> ) @ 25 lb-in (2.8 Nm)
Electrical Life	6000 Switching Operations
Mechanical Life	10000 Switching Operations

**Dimensions**  
(to convert to inches multiply by 0.03937)

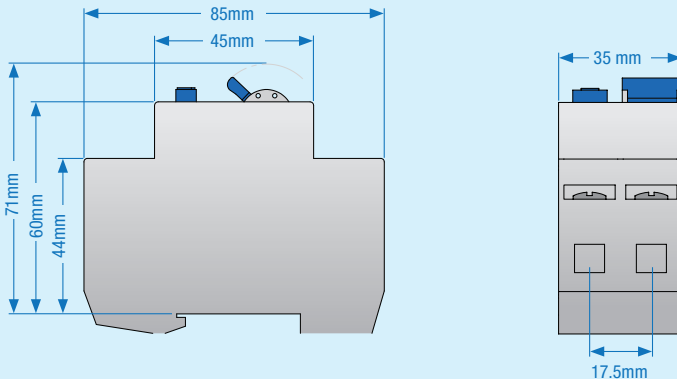

**Weight** 217 g

## GFR Series RCBO Short Circuit Withstand Rating

V	I	IR	Backup
1+N Pole	≤20A	10kA	None
277V AC	>20A	10kA	Class J Fuse 250A or lower Altech L Series Branch Circuit Breaker Altech R Series Supplementary Protector

## GFL Series RCBO Overload Trip Curves

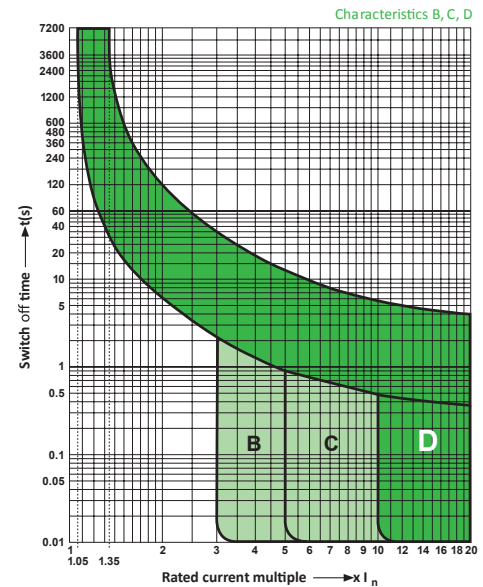

## GFR Series RCBO Ground Fault Trip Curve

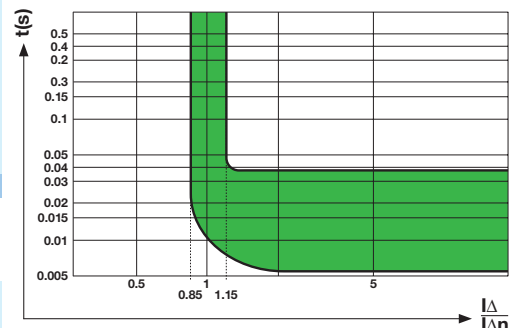

GFR Series - 1 Pole+N, D Trip, 100 mA  
 Applicable voltage systems and wiring examples.

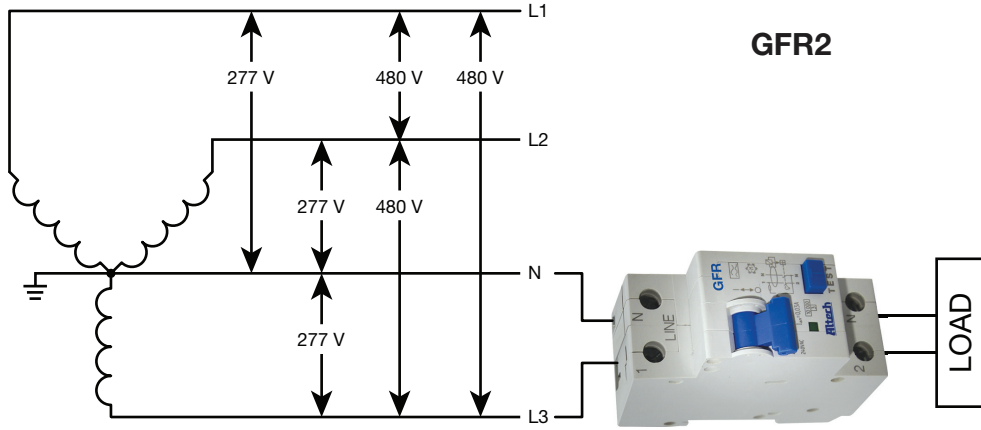

**GFR2**

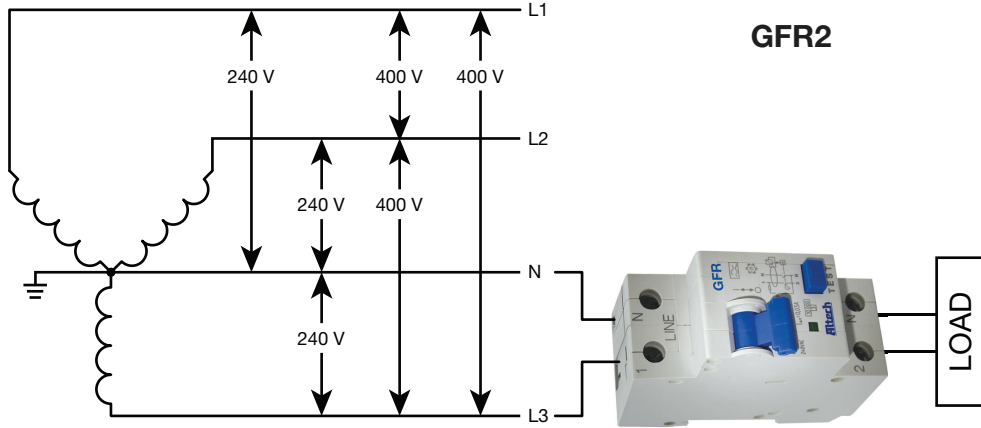

**GFR2**

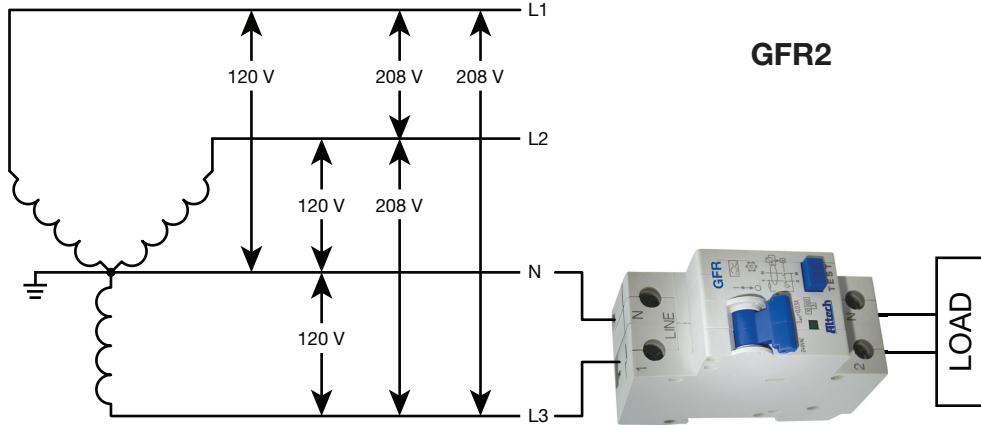

**GFR2**

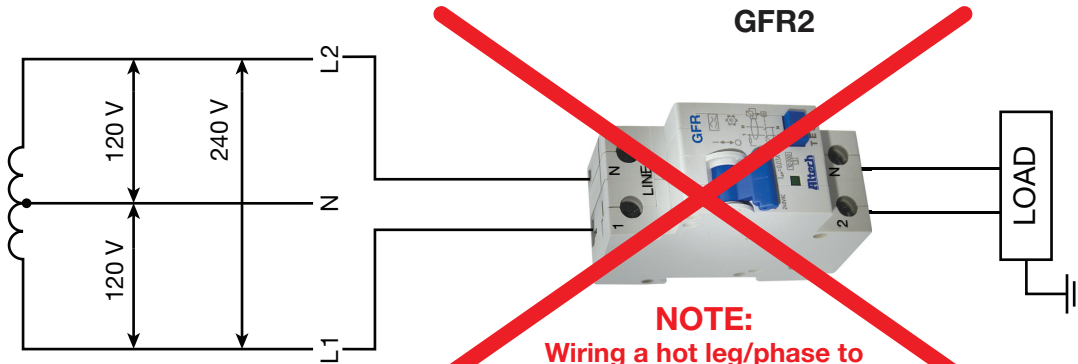

**GFR2**

**NOTE:**  
 Wiring a hot leg/phase to  
 N terminal is not permitted.

**UL 1077**  
 Ground Fault Relay  
 with Overload Protection

## X-ON Electronics

Largest Supplier of Electrical and Electronic Components

*Click to view similar products for [Circuit Breaker Accessories](#) category:*

*Click to view products by [Altech](#) manufacturer:*

Other Similar products are found below :

[CSC-403PS](#) [8T1-D-11A](#) [B151-7184-L](#) [NEB10](#) [8C1-C-721](#) [8T1-E-115](#) [8T1-E-275](#) [8T1-E-278](#) [506-11315-001](#) [3803221](#) [X10506BF](#) [NES 9-](#)  
[1393249-0](#) [802-ESB50UL489](#) [XFPB-4](#) [30.329](#) [X22261102](#) [CX2.5/4/O](#) [Y30019003](#) [PS-1006](#) [618.6335.069](#) [BAC03](#) [JX2.5/4](#) [JX2.5/6](#)  
[JX2.5/5](#) [HSP6/10U](#) [DMRBU BLACK BOX](#) [DB16/BU](#) [CM2.5S2](#) [932146100](#) [930120000](#) [601.1231.909](#) [3PRG1](#) [3PLBR4LU](#) [351.5900.149](#)  
[311.2850.340](#) [2624.0](#) [17BSSV](#) [1-1423696-8](#) [LS3-WH](#) [BAC12](#) [Y30028402](#) [30.617](#) [8T1-E-114](#) [SF06-5,08](#) [2LP199](#) [ZG20-2](#) [3PSML401](#)  
[3PSML402](#) [2LP219](#)