

# GFR Series - 3 Pole+N, D Trip, 30 mA 480Y/277V AC Ground Fault Relay with Overload Protection (RCBO)

The GFR Series is a combined Equipment Ground Fault Relay and Supplementary Protector (RCBO), featuring dual pole switching (live and neutral) and designed to provide protection against overloads and AC ground faults (residual current faults) as well as pulsating DC ground faults.



## Ordering Information

Rated Current	Type/ Cat. No.	Rated Voltage
5.0A	GFR4D05030	480Y/277V AC
6.0A	GFR4D06030	480Y/277V AC
8.0A	GFR4D08030	480Y/277V AC
10A	GFR4D10030	480Y/277V AC
12A	GFR4D12030	480Y/277V AC
13A	GFR4D13030	480Y/277V AC
15A	GFR4D15030	480Y/277V AC
16A	GFR4D16030	480Y/277V AC
20A	GFR4D20030	480Y/277V AC
25A	GFR4D25030	480Y/277V AC
30A	GFR4D30030	480Y/277V AC
32A	GFR4D32030	480Y/277V AC
35A	GFR4D35030	480Y/277V AC
40A	GFR4D40030	480Y/277V AC

**UL 1077**  
Ground Fault Relay  
with Overload Protection

## Technical Specification

Number of Poles	3+N
Voltage Rating (maximum)	480Y/277V AC
Ground Fault Sensitivity Level	30 mA
Short Circuit Withstand Rating	10 kA
Rated Frequency	50/60Hz
Trip Characteristic	D
Cable Size & Tightening Torque	Stranded Wire: 16 - 3 AWG (1.5 mm <sup>2</sup> - 25 mm <sup>2</sup> ) @ 17.5 lb-in (2.0 Nm) Solid Wire: 16 - 10 AWG (1.5 mm <sup>2</sup> - 5.5 mm <sup>2</sup> ) @ 17.5 lb-in (2.0 Nm) 18 - 16 AWG (1 mm <sup>2</sup> - 1.5 mm <sup>2</sup> ) @ 25 lb-in (2.8 Nm)
Electrical Life	6000 Switching Operations
Mechanical Life	10000 Switching Operations

**Dimensions**  
(to convert to inches multiply by 0.03937)

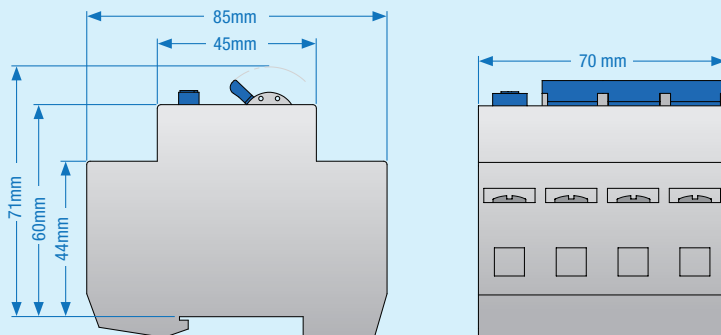

**Weight** 217 g

## GFR Series RCBO Short Circuit Withstand Rating

V	I	IR	Backup
3+N Pole	≤20A	10kA	None
480Y/277V AC	>20A	10kA	Class J Fuse 250A or lower Altech L Series Branch Circuit Breaker Altech R Series Supplementary Protector

## GFL Series RCBO Overload Trip Curves

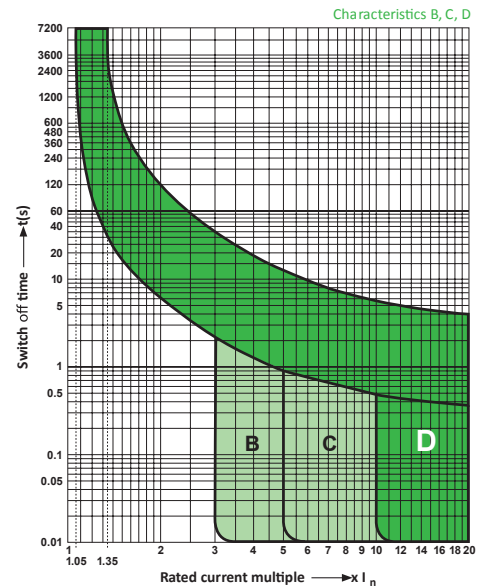

## GFR Series RCBO Ground Fault Trip Curve

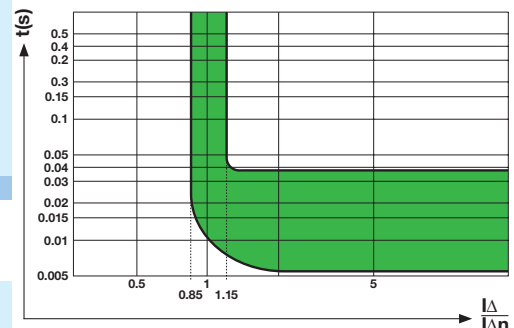

GFR Series - 3 Pole+N, D Trip, 30 mA  
 Applicable voltage systems and wiring examples.

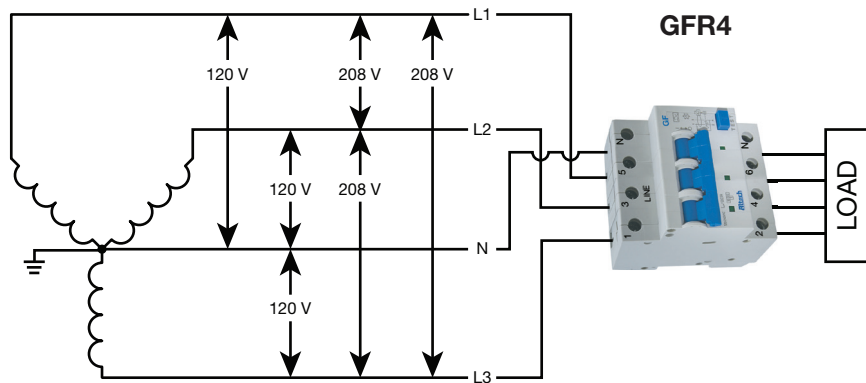
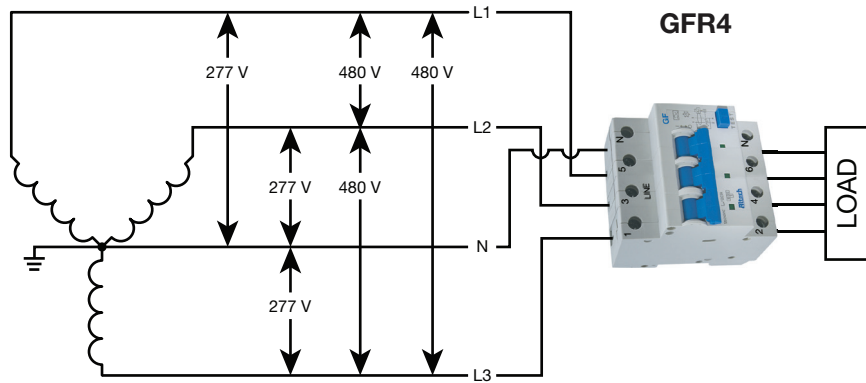

UL 1077  
 Ground Fault Relay  
 with Overload Protection

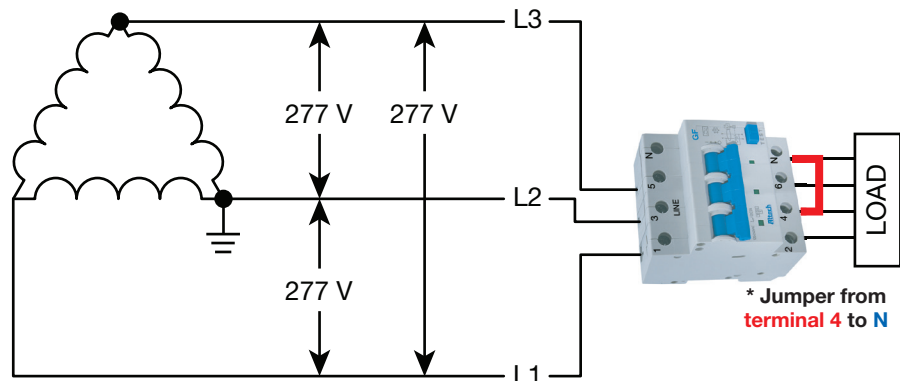
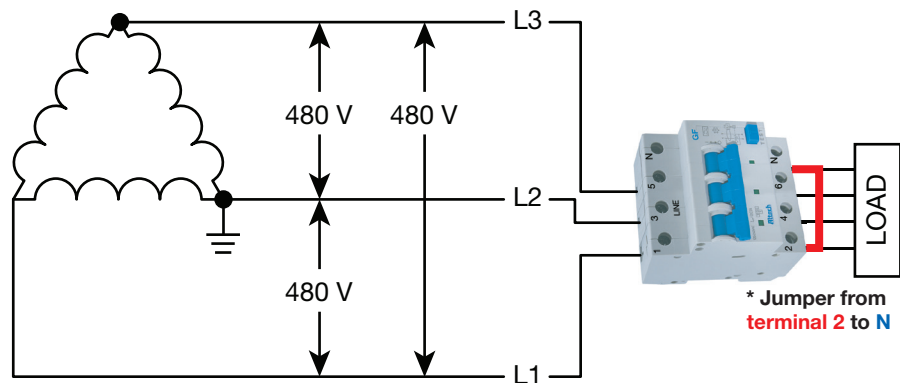
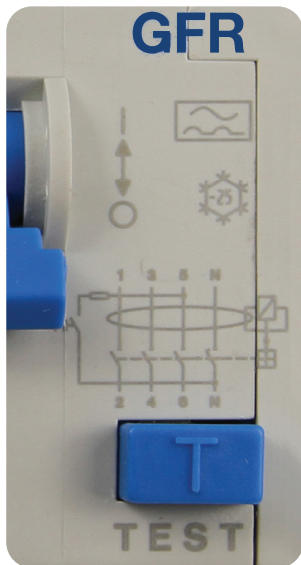

\* Either jumper connection can be used for both voltage configurations.

## X-ON Electronics

Largest Supplier of Electrical and Electronic Components

*Click to view similar products for [Circuit Breaker Accessories](#) category:*

*Click to view products by [Altech](#) manufacturer:*

Other Similar products are found below :

[CSC-403PS](#) [8T1-D-11A](#) [B151-7184-L](#) [NEB10](#) [8C1-C-721](#) [8T1-E-115](#) [8T1-E-275](#) [8T1-E-278](#) [506-11315-001](#) [3803221](#) [X10506BF](#) [NES 9-](#)  
[1393249-0](#) [802-ESB50UL489](#) [XFPB-4](#) [30.329](#) [X22261102](#) [CX2.5/4/O](#) [Y30019003](#) [PS-1006](#) [618.6335.069](#) [BAC03](#) [JX2.5/4](#) [JX2.5/6](#)  
[JX2.5/5](#) [HSP6/10U](#) [DMRBU BLACK BOX](#) [DB16/BU](#) [CM2.5S2](#) [932146100](#) [930120000](#) [601.1231.909](#) [3PRG1](#) [3PLBR4LU](#) [351.5900.149](#)  
[311.2850.340](#) [2624.0](#) [17BSSV](#) [1-1423696-8](#) [LS3-WH](#) [BAC12](#) [Y30028402](#) [30.617](#) [8T1-E-114](#) [SF06-5,08](#) [2LP199](#) [ZG20-2](#) [3PSML401](#)  
[3PSML402](#) [2LP219](#)