

# OVERVIEW

## SCREW TERMINAL BLOCKS

## INTRODUCTION

### SCREW CLAMP CONNECTION TECHNOLOGY

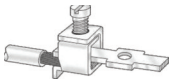

- Maximum wiring efficiency and reliability
- Supplied with open clamps ready to accept wires
- No wire preparation necessary (with/ without ferrule)
- Vibration resistant/ Gas-tight connection
- For very larger wire sizes (up to 250 kcmil)
- Designed for most stringent requirements
- Simple connection with standard flat head screwdriver



60947-7-1

### MATERIAL SPECIFICATIONS

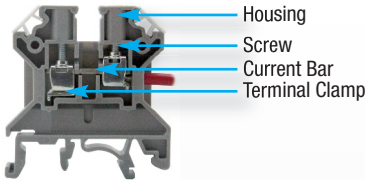

#### Current Carrying Metal *Corrosion free material*

- Clamp: zinc chromate passivated steel
- Screw: zinc chromate passivated steel
- Current Bar: nickel plated copper alloy / tin plated copper

#### Terminal Block Housing

- Polyamide PA66 Housing
- Self-extinguishing
- High mechanical strength

#### Polyamide 66 Specifications

Upper Temperature Limit: 105°C  
Lower Temperature Limit: -50°C  
Flammability UL94: V2/ V0  
Volume Resistivity: 10<sup>12</sup> Ω cm  
Surface Resistivity: 10<sup>10</sup> Ω

### INSTALLATION GUIDELINES

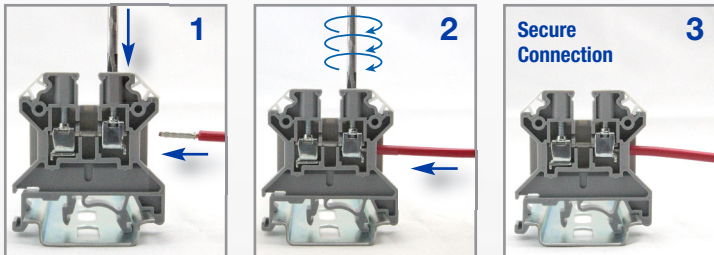

- 1 Insert Wire into open clamp
- 2 Tighten screw to specified torque
- 3 Remove Screwdriver, screw terminal is closed with locking feature for a reliable/ safe connection

### SCREW CLAMP ACCESSORIES AND FEATURES

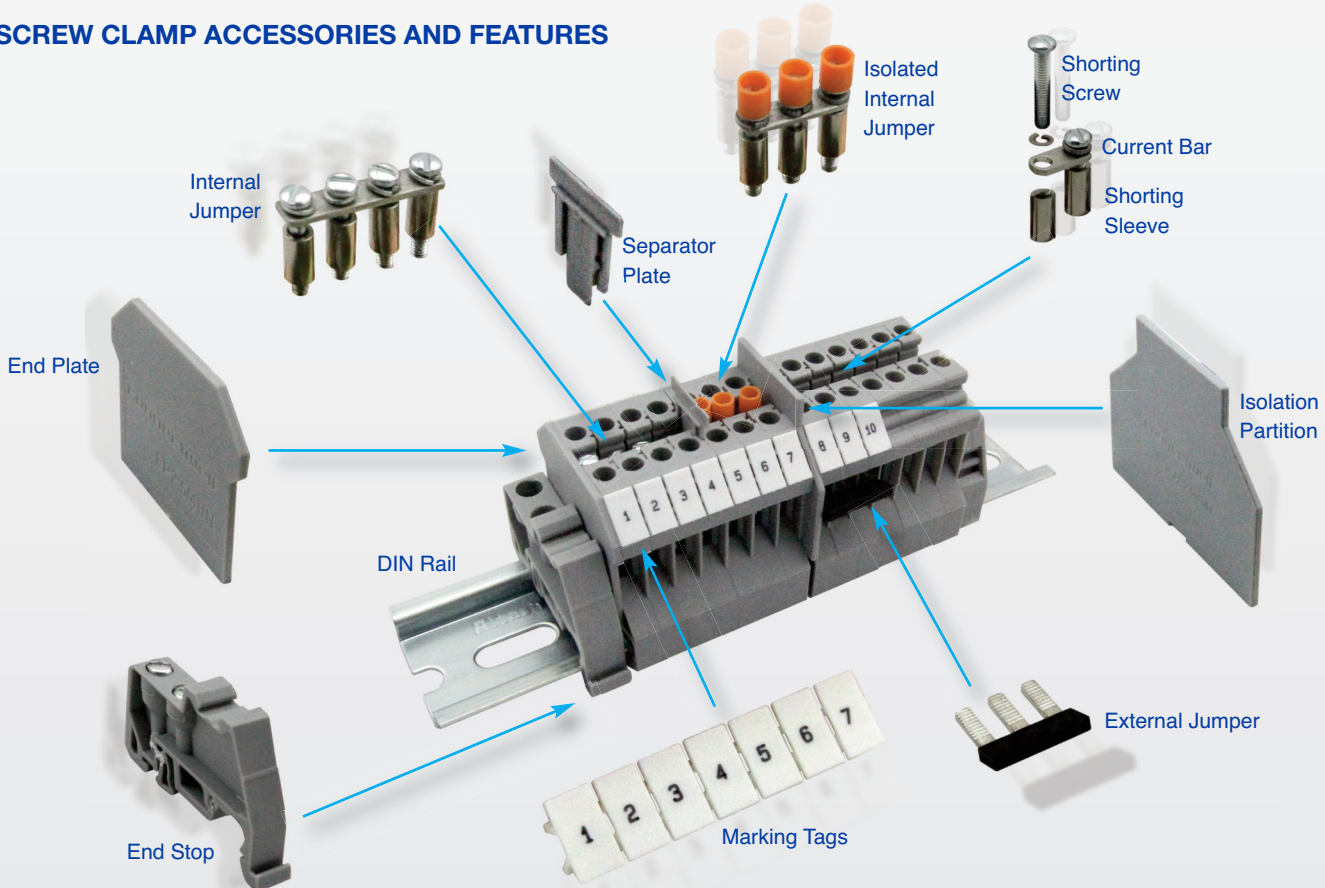

**Feed Through Terminal Blocks**

- Up to 240A
- Multi-Connection Terminals
- Double Level Terminal
- Triple Level Terminals
- Ground Blocks
- Wide range of accessories
- All standard colors

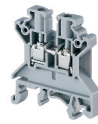

**Feed Through**  
page 6-8



**Multi-Connection**  
page 9



**Double Level**  
page 10-12

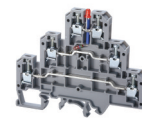

**Triple Level**  
page 14-15



**Ground / Earth**  
page 16-17

**Fuse Terminal Blocks**

- 1/4" x 1" Fuse Terminal Blocks
- 5x20mm/ 5x25mm Fuse Terminal Blocks
- Double level versions
- Component Carrier for flexible requirements
- 10x38, CC, J-Type Fuse Holder



**5x20mm / 5x25mm  
CF4U / CF4SP**  
page 18-19



**Double Lever  
DDFL4U**  
page 20-21

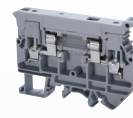

**1/4"x1"  
CAFL4U**  
page 22

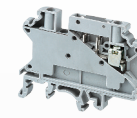

**Component Carrier  
CCC4U**  
page 23



**Fuse Holder**  
page 24-25

**Disconnect & Test Terminal Blocks**

- Slider Style
- Blade/ Knife Style
- Lever Style
- Accessories and matching Feed Through terminals

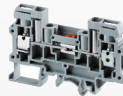

**Slider Style  
CDS6U**  
page 26-27

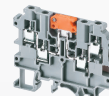

**Blade Style  
CKT4U**  
page 28

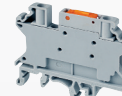

**Blade Style  
CKT4SP**  
page 29

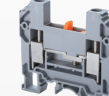

**Slider Style  
CDTTU**  
page 30

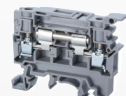

**Lever Style  
CSDL4U**  
page 31

**Power Distribution Terminal Blocks**

- Various I/O configurations
- Up to 150A
- Compact Hybrid Distribution Block

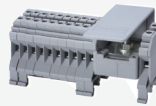

**CDB Series**  
page 32-33



**CMDB Series**  
page 34



**Hybrid CXDB Series**  
page 35



**Distribution/Grounding**  
page 36

**Special Application Terminal Blocks**

- Spring Loaded Terminals for high vibration applications
- 1000V High Voltage Terminals
- Thermocouple Terminals
- Tab Connection Terminals
- Electronic Components Terminals

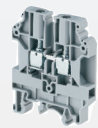

**1000V High Voltage  
CHV Series**  
page 37



**Thermocouple  
CTT2.5U Series**  
page 38

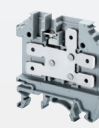

**Tab Connection  
CTC Series**  
page 39

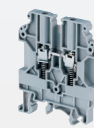

**Spring Loaded  
USC Series**  
page 36-37



**Electronic  
Components**  
page 42-47

**Accessories**

- Internal Jumpers (Uninsulated, Insulated)
- Endplates
- Partition/ Separator Plates
- Protective Covers
- End Stops



**Jumpers**  
page 48



**Endplates, Separators, End Stops, Covers, etc.**  
page 49

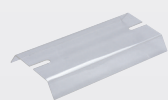
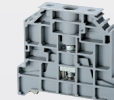

## HIGHLIGHTS

### FEATURES

- Altech CTS Series of Universal Screw Terminal Blocks featuring global standards
- Universal mounting foot for easy snap onto common DIN rail profiles
- Screw-type jumper system
- Current Ratings up to 240A

### APPLICATIONS

- Ex & IECEx approvals for use in potentially explosive areas
- Control, Automation applications
- Power Distribution

### CTS2.5U-N

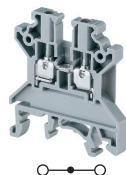

### CTS4U-N

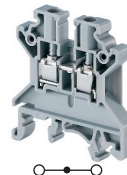

### CTS6U

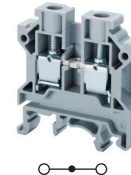

### Dimensions & Weight

	CTS2.5U-N	CTS4U-N	CTS6U
Width	5 mm	6 mm	8 mm
Length	43 mm	43 mm	43 mm
Height w/ DIN Rail	35 x 7.5 mm 35 x 15 mm	46.2 mm 53.7 mm	47.8 mm 55.5 mm
Weight per piece	6.2 g	7.6 g	13.5 g

### Technical Data/Ratings

Approvals	CTS2.5U-N		CTS4U-N		CTS6U	
	UL US E220514	CS US 60947-7-1	UL US E220514	CS US 60947-7-1	UL US E220514	CS US 60947-7-1
Wire Size (solid / stranded)	22-12 AWG	0.2-2.5 mm <sup>2</sup>	22-10 AWG	0.2-4 mm <sup>2</sup>	22-8 AWG	0.5-6 mm <sup>2</sup>
Voltage Rating	600 V	1000V AC/DC	600 V	1000V AC/DC	600 V	1000V AC/DC
Current Rating	25 A	24 A	35 A	32 A	50 A	41 A
Torque	7 lb-in	0.4 Nm	7 lb-in	0.5 Nm	14 lb-in	0.8 Nm
Insulation Material	Polyamide 66		Polyamide 66		Polyamide 66	

### Installation Instructions

	CTS2.5U-N	CTS4U-N	CTS6U
Wire Stripping Length	8 mm	8 mm	9 mm
Screwdriver	Flat Head 0.5 x 3.0 mm	Flat Head 0.6 x 3.5 mm	Flat Head 0.8 x 4.0 mm

### Terminal Blocks

	Cat. No.	Std. Pk.	Cat. No.	Std. Pk.	Cat. No.	Std. Pk.
<b>Grey (standard)</b>	<b>CTS2.5U-N</b>	100	<b>CTS4U-N</b>	100	<b>CTS6U</b>	100
Red R	CTS2.5U-N/R	100	CTS4U-N/R	100	CTS6U/R	100
Blue BU	CTS2.5U-N/BU	100	CTS4U-N/BU	100	CTS6U/BU	100
Black BL	CTS2.5U-N/BL	100	CTS4U-N/BL	100	CTS6U/BL	100
Orange O	CTS2.5U-N/O	100	CTS4U-N/O	100	CTS6U/O	100
Green G	CTS2.5U-N/G	100	CTS4U-N/G	100	CTS6U/G	100
Yellow Y	CTS2.5U-N/Y	100	CTS4U-N/Y	100	CTS6U/Y	100
White W	CTS2.5U-N/W	100	CTS4U-N/W	100	CTS6U/W	100



### Mounting Handle

Mounting handle is used for mounting 10 terminal blocks on a DIN rail, thus saving considerable time. Specially designed pins in the mounting handle grip the terminal blocks when pressed against entry.

Cat. No. Terminal Block Std. Pk.

MH2.5	CTS2.5U-N	1
MH4	CTS4U-N	1



### Accessories

	Cat. No.	Std. Pk.	Cat. No.	Std. Pk.	Cat. No.	Std. Pk.	
End Plate	EP2.5/4UN	50	EP2.5/4UN	50	EP6/10U	50	
Partition Plate	PP2.5/4UN	50	PP2.5/4UN	50	PP6/10U	50	
Separator Plate	SP2.5/4UN	100	SP2.5/4UN	100	SP6/10U	100	
DIN Rail	2511120 CA701-15/S 2511160	20 20 10	2511120 CA701-15/S 2511160	20 20 10	2511120 CA701-15/S 2511160	20 20 10	
End Stop	CA702 CA802 CA202	50 50 25	CA702 CA802 CA202	50 50 25	CA702 CA802 CA202	50 50 25	
Internal Jumper	2 pole 3 pole 4 pole 10 pole 100 pole	CA721/2 CA721/3 CA721/4 CA721/10 CA721/100	100 100 100 10 10	CA722/2 CA722/3 CA722/4 CA722/10 CA722/100	100 100 50 10 10	CA723/2 CA723/3 CA723/4 CA723/10 -	100 50 50 10 -
Insulated Internal Jumper	2 pole 3 pole 4 pole 10 pole 100 pole	CA741/2 CA741/3 CA741/4 CA741/10 CA741/100	100 100 100 10 10	CA742/2 CA742/3 CA742/4 CA742/10 CA742/100	100 100 100 10 10	CA743/2 CA743/3 CA743/4 CA743/10 -	100 50 50 10 -
External Jumper	2 pole 3 pole 4 pole 10 pole	CA717/2 CA717/3 CA717/4 CA717/10	100 100 100 20	CA714/2 CA714/3 CA714/4 CA714/10	100 100 100 20	CA710/2 CA710/3 CA710/4 CA710/10	100 50 50 20
Test Socket	CA707/TS/01	100	CA707/TS/01	100	CA707/TS/05	100	
Marking Tag	MT5	1 Pk. (100 tags)	MT6	1 Pk. (100 tags)	MT8	1 Pk. (100 tags)	

**CTS10U**

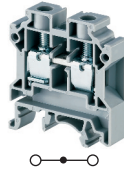

**CTS16U**

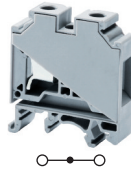

**CTS25U**



**CTS35UN**

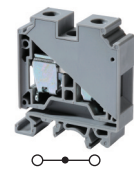

**Dimensions & Weight**

Width	<b>10 mm</b>	<b>12 mm</b>	<b>12 mm</b>	<b>16 mm</b>
Length	43 mm	43 mm	49 mm	50.5 mm
Height w DIN Rail	35 x 7.5 mm 35 x 15 mm	47.8 mm 55.5 mm	47.8 mm 55.5 mm	57.2 mm 64.7 mm
Weight per piece	16.5 g	25.5 g	35.5 g	50.5 g

**Technical Data/Ratings**

Approvals										
Wire Size (solid / stranded)	<b>16-6 AWG</b>	22-6 AWG	0.5-10 mm <sup>2</sup>	<b>20-4 AWG</b>	22-6 AWG	0.2-16 mm <sup>2</sup>	<b>14-2 AWG</b>	4-25 mm <sup>2</sup>	<b>12-1/0 AWG</b>	4-35 mm <sup>2</sup>
Voltage Rating	600 V	600 V	1000V AC/DC	600 V	600 V	1000V AC/DC	600 V	1000V AC/DC	600 V	1000V AC/DC
Current Rating	65 A	65 A	57 A	85 A	70 A	76 A	105 A	101 A	150 A	125 A
Torque	14 lb-in	14 lb-in	1.2 Nm	14 lb-in	14 lb-in	1.2 Nm	30 lb-in	2.0 Nm	50 lb-in	2.5 Nm
Insulation Material	Polyamide 66			Polyamide 66			Polyamide 66		Polyamide 66	

**Installation Instructions**

Wire Stripping Length	11 mm	12 mm	14 mm	15 mm
Screwdriver	Flat Head 0.8 x 4.0 mm	Flat Head 1.0 x 5.5 mm	Flat Head 1.0 x 5.5 mm	Flat Head 1.0 x 5.5 mm

**Terminal Blocks**

	Cat. No.	Std. Pk.	Cat. No.	Std. Pk.	Cat. No.	Std. Pk.	Cat. No.	Std. Pk.
<b>Grey (standard)</b>	<b>CTS10U</b>	100	<b>CTS16U</b>	50	<b>CTS25U</b>	50	<b>CTS35UN</b>	50
Red R	CTS10U/R	100	CTS16U/R	50	CTS25U/R	50	CTS35UN/R	50
Blue BU	CTS10U/BU	100	CTS16U/BU	50	CTS25U/BU	50	CTS35UN/BU	50
Black BL	CTS10U/BL	100	CTS16U/BL	50	CTS25U/BL	50	CTS35UN/BL	50
Orange O	CTS10U/O	100	CTS16U/O	50	CTS25U/O	50	CTS35UN/O	50
Green G	CTS10U/G	100	CTS16U/G	50	CTS25U/G	50	CTS35UN/G	50
Yellow Y	CTS10U/Y	100	CTS16U/Y	50	CTS25U/Y	50	CTS35UN/Y	50
White W	CTS10U/W	100	CTS16U/W	50	CTS25U/W	50	CTS35UN/W	50

**Accessories**

	Cat. No.	Std. Pk.	Cat. No.	Std. Pk.	Cat. No.	Std. Pk.	Cat. No.	Std. Pk.
End Plate	EP6/10U	50	-	-	-	-	-	-
Partition Plate	PP6/10U	50	-	-	PP25UN	50	PP35UN	50
Separator Plate	SP6/10U	100	SP6/10U	100	-	-	-	-
DIN Rail	2511120 CA701-15/S 2511160	20 20 10	2511120 CA701-15/S 2511160	20 20 10	2511120 CA701-15/S 2511160	20 20 10	2511120 CA701-15/S 2511160	20 20 10
End Stop	CA702 CA802 CA202	50 50 25	CA702 CA802 CA202	50 50 25	CA702 CA802 CA202	50 50 25	CA702 CA802 CA202	50 50 25
Internal Jumper	2 pole CA724/2 3 pole CA724/3 4 pole CA724/4 10 pole CA724/10 100 pole -	100 50 50 10 -	2 pole CA751/2 3 pole CA751/3 4 pole CA751/4 10 pole CA751/10 100 pole CA751/100	50 50 50 10 10	2 pole CA725/2 3 pole CA725/3 4 pole CA725/4 10 pole CA725/10 100 pole CA725/100	50 20 20 10 10	2 pole CA771/2 3 pole CA771/3 4 pole CA771/4 10 pole CA771/10 100 pole -	50 20 20 10 -
Insulated Internal Jumper	2 pole CA744/2 3 pole CA744/3 4 pole CA744/4 10 pole CA744/10 100 pole -	100 50 50 10 -	2 pole CA761/2 3 pole CA761/3 4 pole CA761/4 10 pole CA761/10 100 pole CA761/100	100 50 50 10 10	2 pole CA745/2 3 pole CA745/3 4 pole CA745/4 10 pole CA745/10 100 pole CA745/100	50 20 20 10 10	2 pole CA781/2 3 pole CA781/3 4 pole CA781/4 10 pole CA781/10 100 pole -	50 20 20 10 -
External Jumper	2 pole CA718/2 3 pole CA718/3 4 pole CA718/4 10 pole CA718/10	100 50 50 20	- - - -	- - - -	- - - -	- - - -	- - - -	
Test Socket	CA707/TS/05	100	CA707/TS/05	100	CA707/TS/06	100	CA707/TS/06	100
Marking Tag	MT10	1 Pk. (100 tags)	MT12	1 Pk. (100 tags)	MT12	1 Pk. (100 tags)	MT16	1 Pk. (100 tags)



# FEED-THROUGH

## SCREW TERMINAL BLOCKS

## SINGLE LEVEL POWER TERMINAL BLOCKS

### HIGHLIGHTS

#### FEATURES

- DIN Rail and Panel mountable
- Voltage Rating 1000V
- Current Rating up to 240A
- Hex Screw version for easier tightening (NA)
- Auxiliary block for easy plug in

#### APPLICATIONS

- Power Distribution
- Solar Applications
- **AUX6** auxiliary for indicator light or contactor

### CTS50/70N

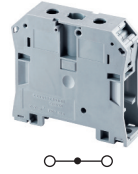

### CTS50/70NA

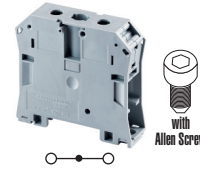

### CTS95/120N

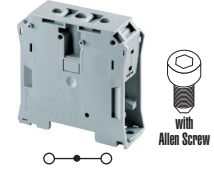

#### Dimensions & Weight

	CTS50/70N	CTS50/70NA	CTS95/120N
Width	20.5 mm	20.5 mm	27.0 mm
Length	77.3 mm	77.3 mm	84.5 mm
Height w DIN Rail	35 x 7.5 mm 35 x 15 mm	71.1 mm 78.1 mm	83.0 mm 90.5 mm
Weight per piece	93.8 g	95.0 g	177.2 g

#### Technical Data/Ratings

Approvals						
Wire Size (solid / stranded)	8-2/0 AWG / 10-70 mm <sup>2</sup>		8-2/0 AWG / 10-70 mm <sup>2</sup>		2-250 KCMIL / 25-120 mm <sup>2</sup>	
Voltage Rating	1000 V / 1000 V AC/DC		1000 V / 1000 V AC/DC		1000 V / 1000 V AC/DC	
Current Rating	175 A / 192 A		175 A / 192 A		240 A / 269 A	
Torque	38 lb-in / 3.0 Nm		38 lb-in / 3.0 Nm		90 lb-in / 6.0 Nm	
Insulation Material	Polyamide 66					

#### Installation Instructions

Wire Stripping Length	22 mm	22 mm	24 mm
Screwdriver	Flat Head 1.0x7.5 mm	Allen Wrench 5 mm	Allen Wrench 6 mm

#### Terminal Blocks

	Cat. No.	Std. Pk.	Cat. No.	Std. Pk.	Cat. No.	Std. Pk.
<b>Grey (standard)</b>	<b>CTS50/70N</b>	20	<b>CTS50/70NA</b>	20	<b>CTS95/120N</b>	10
Red R	CTS50/70N/R	20	CTS50/70NA/R	20	CTS95/120N/R	10
Blue BU	CTS50/70N/BU	20	CTS50/70NA/BU	20	CTS95/120N/BU	10
Black BL	CTS50/70N/BL	20	CTS50/70NA/BL	20	CTS95/120N/BL	10
Orange O	CTS50/70N/O	20	CTS50/70NA/O	20	CTS95/120N/O	10
Green G	CTS50/70N/G	20	CTS50/70NA/G	20	CTS95/120N/G	10
Yellow Y	CTS50/70N/Y	20	CTS50/70NA/Y	20	CTS95/120N/Y	10
White W	CTS50/70N/W	20	CTS50/70NA/W	20	CTS95/120N/W	10

#### Accessories

	Cat. No.	Std. Pk.	Cat. No.	Std. Pk.	Cat. No.	Std. Pk.
DIN Rail	2511120 CA701-15/S 2511160	20 20 10	2511120 CA701-15/S 2511160	20 20 10	2511120 CA701-15/S 2511160	20 20 10
End Stop	CA702 CA802 CA202	50 50 25	CA702 CA802 CA202	50 50 25	CA702 CA802 CA202	50 50 25
Shorting Link System	CA628/2 CA628/3	10 10	CA628/2 CA628/3	10 10	CA629/2 CA629/3	10 10
Marking Tag	MT16	1 Pk. (100 tags)	MT16	1 Pk. (100 tags)	MT16	1 Pk. (100 tags)

#### Cat. No AUX6

##### Auxiliary Terminal Block

Used for:  
CTS50/70N  
CTS50/70NA  
CTS95/120N

In certain power circuits, there is a need to take an extra connection for an Auxiliary circuit like an indicating light or contactor. The AUX6 terminal easily plugs into the terminal and provides this extra connection point.



##### Ratings

###### IEC60947-7-1

Voltage/Current: 1000 V / 41 A  
Torque: 0.8 Nm

###### IEC 60079-7

Voltage/Current: 630 V / 36 A  
Torque: 0.8 Nm

###### UL-1059

Voltage/Current: 600 V / 50 A  
Torque: 14 lb-in

###### CSA22.2-158

Voltage/Current: 600 V / 50 A  
Torque: 14 lb-in

Wire Range: 22-8 AWG

Width x Length x Height: 8 x 53.6 x 29.4 mm

Std. Pk.: 10

Marking Tag: MT8

**CMC1-2**



**CMC2-2**

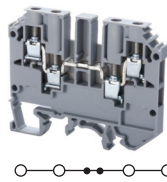

**CMCG4**

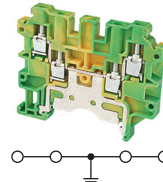

**Dimensions & Weight**

Width	6 mm		6 mm		6 mm	
Length	46.5 mm		65.0 mm		65.0 mm	
Height w/ DIN Rail	35 x 7.5 mm 35 x 15 mm	49.5 mm 56.5 mm	53.4 mm 60.5 mm	53.7 mm 60.9 mm	53.7 mm 60.9 mm	
Weight per piece	11.0 g		16.0 g		21.6 g	

**Technical Data/Ratings**

Approvals						
Wire Size (solid / stranded)	<b>22-10 AWG</b>	0.2-4 mm <sup>2</sup>	<b>22-10 AWG</b>	0.2-4 mm <sup>2</sup>	<b>24-10 AWG</b>	0.2-4 mm <sup>2</sup>
Voltage Rating	600 V	630 V AC/DC	600 V	630 V AC/DC	600 V	1000 V AC/DC
Current Rating	35 A	32 A	35 A	32 A	-	-
Torque	7 lb-in	0.5 Nm	7 lb-in	0.5 Nm	4.5 lb-in	0.5 Nm
Insulation Material	Polyamide 66		Polyamide 66		Polyamide 66	

**Installation Instructions**

Wire Stripping Length	9 mm		9 mm		9 mm	
Screwdriver	Flat Head 0.6 x 3.5 mm		Flat Head 0.6 x 3.5 mm		Flat Head 0.6 x 3.5 mm	

**Terminal Blocks**

	Cat. No.	Std. Pk.	Cat. No.	Std. Pk.	Cat. No.	Std. Pk.
<b>Grey (standard)</b>	<b>CMC1-2</b>	100	<b>CMC2-2</b>	50	<b>CMCG4</b>	50
Red R	CMC1-2/R	100	CMC2-2/R	50	Yellow/Green	
Blue BU	CMC1-2/BU	100	CMC2-2/BU	50		
Black BL	CMC1-2/BL	100	CMC2-2/BL	50		
Orange O	CMC1-2/O	100	CMC2-2/O	50		
Green G	CMC1-2/G	100	CMC2-2/G	50		
Yellow Y	CMC1-2/Y	100	CMC2-2/Y	50		
White W	CMC1-2/W	100	CMC2-2/W	50		

**Accessories**

	Cat. No.	Std. Pk.	Cat. No.	Std. Pk.	Cat. No.	Std. Pk.
End Plate	EPCMC1-2	50	EPCMC2-2	50	EPCMC2-2	50
DIN Rail	2511120 CA701-15/S 2511160	20 20 10	2511120 CA701-15/S 2511160	20 20 10	2511120 CA701-15/S 2511160	20 20 10
End Stop	CA702 CA802 CA202	50 50 25	CA702 CA802 CA202	50 50 25	CA702 CA802 CA202	50 50 25
Internal Jumper	2 pole CA722/2 3 pole CA722/3 4 pole CA722/4 10 pole CA722/10 100 pole CA722/100	100 100 50 10 10	2 pole CA722/2 3 pole CA722/3 4 pole CA722/4 10 pole CA722/10 100 pole CA722/100	100 100 50 10 10	- - - - -	- - - - -
Insulated Internal Jumper	2 pole CA742/2 3 pole CA742/3 4 pole CA742/4 10 pole CA742/10 100 pole CA742/100	100 100 100 10 10	2 pole CA742/2 3 pole CA742/3 4 pole CA742/4 10 pole CA742/10 100 pole CA742/100	100 100 100 10 10	- - - - -	- - - - -
External Jumper	2 pole CA713/2 3 pole CA713/3 4 pole CA713/4 10 pole CA713/10	100 100 100 20	2 pole CA713/2 3 pole CA713/3 4 pole CA713/4 10 pole CA713/10	100 100 100 20	- - - -	- - - -
Test Socket	CA707/TS/01		CA707/TS/01		-	-
Marking Tag	MT6	1 Pk. (100 tags)	MT6	1 Pk. (100 tags)	MT6	1 Pk. (100 tags)

**HIGHLIGHTS**

**FEATURES**

- 3 to 4 connections
- Up to 2 connection points on each side
- 2 jumper channels on **CMC2-2** for individual potential distribution
- **CMCG4** same profile as regular feed-through version

**APPLICATIONS**

- Connecting different type of wires with different wire sizes into a single terminal block
- Simple distribution applications

### HIGHLIGHTS

#### FEATURES

- Accommodates larger **MT6** marking tags on both levels
- Independent and internally shorted version
- CDL4UN** offers jumper channel on both levels
- Same profile Ground versions
- Grounding Level on **CDLG4** is identified by green/yellow imprint

#### APPLICATIONS

- High density wiring applications

### CDL4UN

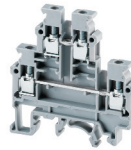

### CDL4UN(I.S)

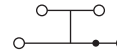
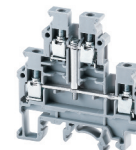

#### Dimensions & Weight

	CDL4UN	CDL4UN(I.S)
Width	6 mm	6 mm
Length	57.0 mm	57.0 mm
Height w DIN Rail	59.5 mm 67.2 mm	59.5 mm 67.2 mm
Weight per piece	13.8 g	15.6 g

#### Technical Data/Ratings

Approvals	CDL4UN		CDL4UN(I.S)	
CE, Ex, IECEx, Lowvoltage, IEC	C US E220514	C SP US 60947-7-1	C US E220514	C SP US 60947-7-1
Wire Size (solid / stranded)	22-10 AWG	0.2-4 mm <sup>2</sup>	22-10 AWG	0.2-4 mm <sup>2</sup>
Voltage Rating	600 V	800 V AC/DC	600 V	800 V AC/DC
Current Rating	35 A	32 A	35 A	32 A
Torque	7 lb-in	0.5Nm	7 lb-in	0.5Nm
Insulation Material	Polyamide 66		Polyamide 66	

#### Installation Instructions

Wire Stripping Length	9 mm	9 mm
Screwdriver	Flat Head 0.6 x 3.5 mm	Flat Head 0.6 x 3.5 mm

#### Terminal Blocks

	Cat. No.	Std. Pk.	Cat. No.	Std. Pk.
<b>Grey (standard)</b>	<b>CDL4UN</b>	100	<b>CDL4UN(I.S)</b>	100
Red R	CDL4UN/R	100	CDL4UN(I.S)/R	100
Blue BU	CDL4UN/BU	100	CDL4UN(I.S)/BU	100
Black BL	CDL4UN/BL	100	CDL4UN(I.S)/BL	100
Orange O	CDL4UN/O	100	CDL4UN(I.S)/O	100
Green G	CDL4UN/G	100	CDL4UN(I.S)/G	100
Yellow Y	CDL4UN/Y	100	CDL4UN(I.S)/Y	100
White W	CDL4UN/W	100	CDL4UN(I.S)/W	100

#### Accessories

	Cat. No.	Std. Pk.	Cat. No.	Std. Pk.
End Plate	EPCDL4UN	50	EPCDL4UN	50
Separator Plate	SPCDL4U	100	SPCDL4U	100
DIN Rail	2511120 CA701-15/S 2511160	20 20 10	2511120 CA701-15/S 2511160	20 20 10
End Stop	CA702 CA802 CA202	50 50 25	CA702 CA802 CA202	50 50 25
Internal Jumper	2 pole 3 pole 4 pole 10 pole 100 pole	CA722/2 CA722/3 CA722/4 CA722/10 CA722/100	100 100 100 10 10	CA722/2 CA722/3 CA722/4 CA722/10 CA722/100
Insulated Internal Jumper	2 pole 3 pole 4 pole 10 pole 100 pole	CA742/2 CA742/3 CA742/4 CA742/10 CA742/100	100 100 100 10 10	CA742/2 CA742/3 CA742/4 CA742/10 CA742/100
External Jumper	2 pole 3 pole 4 pole 10 pole	CA714/2 CA714/3 CA714/4 CA714/10	100 50 50 20	CA714/2 CA714/3 CA714/4 CA714/10
Test Socket	CA707/TS/01	100	CA707/TS/01	100
Marking Tag	MT6	1 Pk. (100 tags)	MT6	1 Pk. (100 tags)

### FEED THROUGH DOUBLE LEVEL

#### CDLG4(I.S)

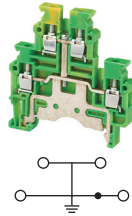

#### CDLG4

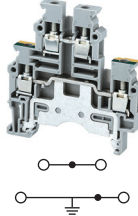

#### CDLG2.5

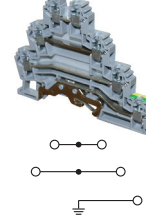

#### Dimensions & Weight

Width	6 mm	6 mm	6 mm
Length	57.0 mm	57.0 mm	71.0 mm
Height w DIN Rail	35 x 7.5 mm 35 x 15 mm	59.5 mm 67.2 mm	59.5 mm 67.2 mm
Weight per piece	22.2 g	20.6 g	20.2 g

#### Technical Data/Ratings

Approvals						
Wire Size (solid / stranded)	24-10 AWG	0.2-4 mm <sup>2</sup>	24-10 AWG	0.2-4 mm <sup>2</sup>	24-12 AWG	0.2-2.5 mm <sup>2</sup>
Voltage Rating	150 V	500 V AC/DC	150 V	500 V AC/DC	300 V	500 V
Current Rating	-	-	32 A (upper level)	32 A	24 A	24 A
Torque	4.5 lb-in	0.5 Nm	4.5 lb-in	0.5 Nm	4.5 lb-in	0.4 Nm
Insulation Material	Polyamide 66		Polyamide 66		Polyamide 66	

#### Installation Instructions

Wire Stripping Length	8 mm	8 mm	9 mm
Screwdriver	Flat Head 0.6 x 3.5 mm	Flat Head 0.6 x 3.5 mm	Flat Head 0.5 x 3.0 mm

#### Terminal Blocks

	Cat. No.	Std. Pk.	Cat. No.	Std. Pk.	Cat. No.	Std. Pk.
<b>Yellow/Green</b>	<b>CDLG4(I.S)</b>	100	<b>CDLG4</b>	100	<b>CDLG2.5</b>	100

#### Accessories

	Cat. No.	Std. Pk.	Cat. No.	Std. Pk.	Cat. No.	Std. Pk.	
End Plate	EPCDL4UN	50	EPCDL4UN	50	EPCDLG2.5	50	
Separator Plate	SPCDL4U	100	SPCDL4U	100	SPCDLG2.5	100	
DIN Rail	2511120 CA701-15/S 2511160	20 20 10	2511120 CA701-15/S 2511160	20 20 10	2511120 CA701-15/S 2511160	20 20 10	
End Stop	CA702 CA802 CA202	50 50 25	CA702 CA802 CA202	50 50 25	CA702 CA802 CA202	50 50 25	
Internal Jumper	2 pole 3 pole 4 pole 10 pole 100 pole	CA722/2 CA722/3 CA722/4 CA722/10 CA722/100	100 100 50 10 10	CA722/2 CA722/3 CA722/4 CA722/10 CA722/100	100 100 50 10 10	CA627/2 CA627/3 CA627/4 CA627/10 -	100 100 100 10 -
Insulated Internal Jumper	2 pole 3 pole 4 pole 10 pole 100 pole	CA742/2 CA742/3 CA742/4 CA742/10 CA742/100	100 100 100 10 10	CA742/2 CA742/3 CA742/4 CA742/10 CA742/100	100 100 100 10 10	- - - - -	- - - - -
External Jumper	2 pole 3 pole 4 pole 10 pole	CA714/2 CA714/3 CA714/4 CA714/10	100 50 50 20	CA714/2 CA714/3 CA714/4 CA714/10	100 50 50 20	CA715/2 CA715/3 CA715/4 CA715/10	100 100 100 20
Test Socket	CA707/TS/01	100	CA707/TS/01	100	CA707/TS/01	100	
Marking Tag	MT6	1 Pk. (100 tags)	MT6	1 Pk. (100 tags)	MT2G	1 Pk. (100 tags)	



# DOUBLE LEVEL

## SCREW TERMINAL BLOCKS

### HIGHLIGHTS

#### FEATURES

- Top Level is offset by half terminal width from lower level
- Offset allows better access to both levels even when fully wired
- Different Endplates for front and back side guarantee flush mounting to neighboring terminal blocks or end stops  
(EPODL4U and EP1ODL4U)

#### APPLICATIONS

- High density wiring applications

## FEED THROUGH OFFSET DOUBLE LEVEL

### ODL4U

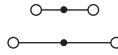
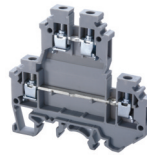

#### Dimensions & Weight

<b>Width</b>	
Length	
Height w DIN Rail	35 x 7.5 mm 35 x 15 mm
Weight per piece	

<b>6 mm</b>
68 mm
65.0 mm 71.1 mm
14.5 g

#### Technical Data/Ratings

Approvals		
Wire Size (solid / stranded)	22-10 AWG	
Voltage Rating	600 V	800 VAC/DC
Current Rating	35 A	32 A
Torque	7 lb-in	0.5 Nm
Insulation Material	Polyamide 66	

22-10 AWG	0.2-4 mm <sup>2</sup>	
600 V	800 VAC/DC	
35 A	32 A	
7 lb-in	0.5 Nm	
Polyamide 66		

#### Installation Instructions

Wire Stripping Length	
Screwdriver	

9 mm
Flat Head 0.6 x 3.5 mm

#### Terminal Blocks

Grey (standard)		
Red	R	
Blue	BU	
Black	BL	
Orange	O	
Green	G	
Yellow	Y	
White	W	

Cat. No.	Std. Pk.
<b>ODL4U</b>	100
ODL4U/R	100
ODL4U/BU	100
ODL4U/BL	100
ODL4U/O	100
ODL4U/G	100
ODL4U/Y	100
ODL4U/W	100

#### Accessories

End Plate	
Separator Plate	
DIN Rail	
End Stop	
Internal Jumper	2 pole 3 pole 4 pole 10 pole 100 pole 
Insulated Internal Jumper	2 pole 3 pole 4 pole 10 pole 100 pole 
External Jumper	2 pole 3 pole 4 pole 10 pole 
Test Socket	
Marking Tag	

Cat. No.	Std. Pk.
EPODL4U (Front)	50
EP1ODL4U (Back)	50
SPCDL4U	100
2511120	20
CA701-15/S	20
2511160	10
CA702	50
CA802	50
CA202	25
CA727/2	100
CA727/3	100
CA727/4	100
CA727/10	10
CA727/100	10
CA747/2	100
CA747/3	100
CA747/4	100
CA747/10	10
CA747/100	10
CA714/2	100
CA714/3	100
CA714/4	100
CA714/10	20
CA707/TS/01	
MT6	1 Pk. (100 tags)

ODL4U  
(without End Plates)

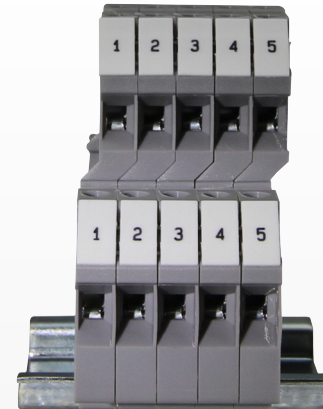

ODL4U  
(with End Plates)

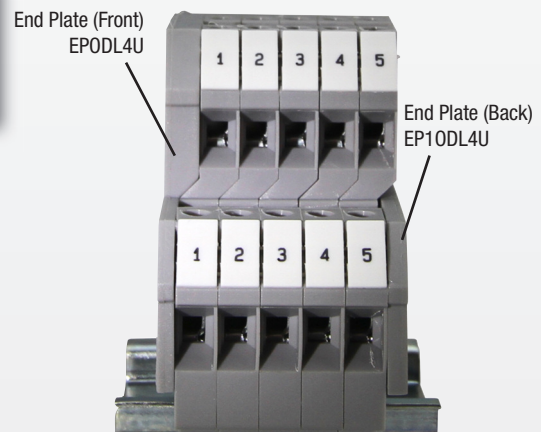

## FEED THROUGH DOUBLE LEVEL

### ODL2.5

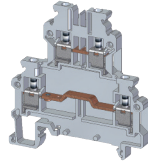

### ODL2.5(I.S)

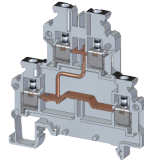

### ODLG2.5

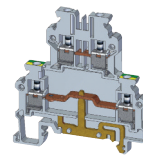

### ODLG2.5(I.S)

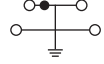
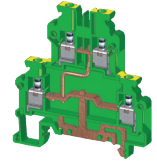

### Dimensions & Weight

	ODL2.5	ODL2.5(I.S)	ODLG2.5	ODLG2.5(I.S)
Width	5 mm	5 mm	5 mm	5 mm
Length	62.0 mm	62.0 mm	62.0 mm	62.0 mm
Height w DIN Rail	35 x 7.5 mm 35 x 15 mm	63.0 mm 70.5 mm	63.0 mm 70.5 mm	63.0 mm 70.5 mm
Weight per piece	13.0 g	14.2 g	15.3 g	17.0 g

### Technical Data/Ratings

Approvals	UL		IEC		UL		IEC	
	60947-7-1		60947-7-1		60947-7-1		60947-7-1	
Wire Size (solid / stranded)	24-12 AWG	0.2-2.5 mm <sup>2</sup>	24-12 AWG	0.2-2.5 mm <sup>2</sup>	24-12 AWG	0.2-2.5 mm <sup>2</sup>	24-12 AWG	0.2-2.5 mm <sup>2</sup>
Voltage Rating	300 V	800 V AC/DC	300 V	800 V AC/DC	300 V	800 V AC/DC	300 V	800 V AC/DC
Current Rating	25 A	24 A	25 A	24 A	25 A	24 A	24 A	24 A
Torque	4.5 lb-in	0.4 Nm	4.5 lb-in	0.4 Nm	4.5 lb-in	0.4 Nm	4.5 lb-in	0.4 Nm
Insulation Material	Polyamide 66		Polyamide 66		Polyamide 66		Polyamide 66	

### Installation Instructions

Wire Stripping Length	8 mm	8 mm	8 mm	8 mm
Screwdriver	Flat Head 0.6 x 3.5 mm	Flat Head 0.6 x 3.5 mm	Flat Head 0.6 x 3.5 mm	Flat Head 0.6 x 3.5 mm

### Terminal Blocks

	Cat. No.	Std. Pk.	Cat. No.	Std. Pk.	Cat. No.	Std. Pk.	Cat. No.	Std. Pk.
<b>Grey Stackable Clip-on</b>	<b>ODL2.5</b>	50	<b>ODL2.5(I.S)</b>	50	<b>ODLG2.5</b>	50	<b>ODLG2.5(I.S)</b>	50
	ODL2.5A	50	ODL2.5A(I.S)	50	ODLG2.5A	50	ODLG2.5A(I.S)	50

### Accessories

	Cat. No.	Std. Pk.	Cat. No.	Std. Pk.	Cat. No.	Std. Pk.	Cat. No.	Std. Pk.
<b>End Plate</b>	EP0DL2.5	50	EP0DL2.5	50	EP0DL2.5	50	EP0DL2.5	50
	EP1ODL2.5	50	EP1ODL2.5	50	EP1ODL2.5	50	EP1ODL2.5	50
<b>DIN Rail</b>	2511120	20	2511120	20	2511120	20	2511120	20
	CA701-15/S	20	CA701-15/S	20	CA701-15/S	20	CA701-15/S	20
<b>End Stop</b>	CA702	50	CA702	50	CA702	50	CA702	50
	CA802	50	CA802	50	CA802	50	CA802	50
	CA202	25	CA202	25	CA202	25	CA202	25
<b>Shorting Link/Jumpers</b>	JX2.5/2	100	JX2.5/2	100	JX2.5/2	100	JX2.5/2	100
	JX2.5/3	50	JX2.5/3	50	JX2.5/3	50	JX2.5/3	50
	JX2.5/4	50	JX2.5/4	50	JX2.5/4	50	JX2.5/4	50
	JX2.5/5	50	JX2.5/5	50	JX2.5/5	50	JX2.5/5	50
	JX2.5/6	10	JX2.5/6	10	JX2.5/6	10	JX2.5/6	10
	JX2.5/7	10	JX2.5/7	10	JX2.5/7	10	JX2.5/7	10
	JX2.5/8	10	JX2.5/8	10	JX2.5/8	10	JX2.5/8	10
	JX2.5/10	10	JX2.5/10	10	JX2.5/10	10	JX2.5/10	10
<b>Marking Tag</b>	MT5	1 Pk. (100 tags)	MT5	1 Pk. (100 tags)	MT5	1 Pk. (100 tags)	MT5	1 Pk. (100 tags)

# TRIPLE LEVEL

## SCREW TERMINAL BLOCKS

## FEED THROUGH TRIPLE LEVEL

### HIGHLIGHTS

#### FEATURES

- 3 Feed through levels
- Marking Tag space on all 3 levels
- Independent Levels and internally shorted version **CTL2.5U(I.S)**
- LED versions to show switching indication in various voltages - **CTL2.5U(L)/XX**
- 3 Level terminal with additional grounding level **CTLG2.5**

#### APPLICATIONS

- Control Systems with sensor applications
- Actuator applications
- Motor applications
- Applications with high wire density

### CTL2.5U

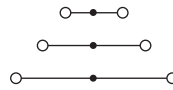
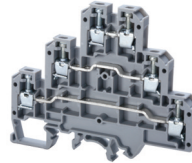

### CTL2.5U-H

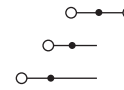
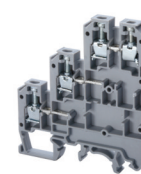

### CTL2.5U(I.S)

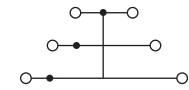
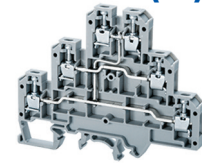

#### Dimensions & Weight

	CTL2.5U	CTL2.5U-H	CTL2.5U(I.S)
Width	6 mm	6 mm	6 mm
Length	84.0 mm	61.0 mm	84.0 mm
Height w DIN Rail	35 x 7.5 mm 35 x 15 mm	68.0 mm 75.6 mm	68.0 mm 75.6 mm
Weight per piece	20.0 g	21.0 g	21.0 g

#### Technical Data/Ratings

Approvals						
Wire Size (solid / stranded)	22-12 AWG	0.2-2.5 mm <sup>2</sup>	22-12 AWG	0.2-2.5 mm <sup>2</sup>	22-12 AWG	0.2-2.5 mm <sup>2</sup>
Voltage Rating	300 V	500 V AC/DC	300 V	500 V AC/DC	150 V	500 V AC/DC
Current Rating	25 A	24 A	25 A	24 A	25 A	24 A
Torque	4.5 lb-in	0.4 Nm	4.5 lb-in	0.4 Nm	4.5 lb-in	0.4 Nm
Insulation Material	Polyamide 66		Polyamide 66		Polyamide 66	

#### Installation Instructions

	CTL2.5U	CTL2.5U-H	CTL2.5U(I.S)
Wire Stripping Length	9 mm	9 mm	9 mm
Screwdriver	Flat Head 0.5 x 3.0 mm	Flat Head 0.5 x 3.0 mm	Flat Head 0.5 x 3.0 mm

#### Terminal Blocks

	Cat. No.	Std. Pk.	Cat. No.	Std. Pk.	Cat. No.	Std. Pk.
<b>Grey (standard)</b>	<b>CTL2.5U</b>	50	<b>CTL2.5U-H</b>	50	<b>CTL2.5U(I.S)</b>	50
Red R	CTL2.5U/R	50	CTL2.5U-H/R	50	CTL2.5U(I.S)/R	50
Blue BU	CTL2.5U/BU	50	CTL2.5U-H/BU	50	CTL2.5U(I.S)/BU	50
Black BL	CTL2.5U/BL	50	CTL2.5U-H/BL	50	CTL2.5U(I.S)/BL	50
Orange O	CTL2.5U/O	50	CTL2.5U-H/O	50	CTL2.5U(I.S)/O	50
Green G	CTL2.5U/G	50	CTL2.5U-H/G	50	CTL2.5U(I.S)/G	50
Yellow Y	CTL2.5U/Y	50	CTL2.5U-H/Y	50	CTL2.5U(I.S)/Y	50
White W	CTL2.5U/W	50	CTL2.5U-H/W	50	CTL2.5U(I.S)/W	50

#### Accessories

	Cat. No.	Std. Pk.	Cat. No.	Std. Pk.	Cat. No.	Std. Pk.
End Plate	EPCTL2.5U	50	EPCTL2.5U-H	50	EPCTL2.5U	50
DIN Rail	2511120	20	2511120	20	2511120	20
	CA701-15/S	20	CA701-15/S	20	CA701-15/S	20
	2511160	10	2511160	10	2511160	10
End Stop	CA702	50	CA702	50	CA702	50
	CA802	50	CA802	50	CA802	50
	CA202	25	CA202	25	CA202	25
Internal Jumper	CA722/2	100	CA722/2	100	CA722/2	100
	CA722/3	100	CA722/3	100	CA722/3	100
	CA722/4	100	CA722/4	100	CA722/4	100
	CA722/10	10	CA722/10	10	CA722/10	10
	CA722/100	10	CA722/100	10	CA722/100	10
External Jumper	CA715/2	100	CA715/2	100	CA715/2	100
	CA715/3	100	CA715/3	100	CA715/3	100
	CA715/4	100	CA715/4	100	CA715/4	100
	CA715/10	20	CA715/10	20	CA715/10	20
Test Socket	CA707/TS/01	100	CA707/TS/01	100	CA707/TS/01	100
Marking Tag	MT2	1 Pk. (100 tags)	MT2	1 Pk. (100 tags)	MT2	1 Pk. (100 tags)

**CTL2.5U-H(L)/XX**

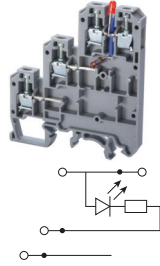

**CTL2.5U(L)/XX**

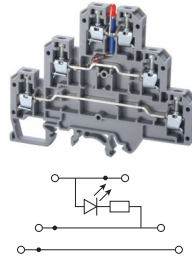

**CTL2.5UH(I.S)D2**

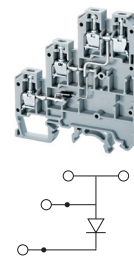

**CTLG2.5**

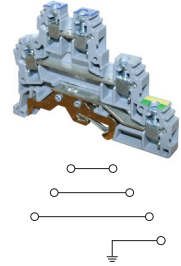

**Dimensions & Weight**

Width	6 mm		6 mm		6 mm		6 mm	
Length	61.0 mm		84.0 mm		61.0 mm		87.5 mm	
Height w DIN Rail	35 x 7.5 mm 35 x 15 mm	68.0 mm 75.6 mm	68.0 mm 75.6 mm	68.0 mm 75.6 mm	68.0 mm 75.6 mm	66.0 mm 74.0 mm	66.0 mm 74.0 mm	27.4 g
Weight per piece	21.0 g		21.0 g		15.1 g		27.4 g	

**Technical Data/Ratings**

Approvals 								
Wire Size (solid / stranded)	22-12 AWG	0.2-2.5 mm <sup>2</sup>	22-12 AWG	0.2-2.5 mm <sup>2</sup>	22-12 AWG	0.2-2.5 mm <sup>2</sup>	24-12 AWG	0.2-2.5 mm <sup>2</sup>
Voltage Rating	300 V	500 V AC/DC	300 V	500 V AC/DC	150 V	500 V AC/DC	300 V	440 V
Current Rating	25 A	24 A	25 A	24 A	25 A	24 A	24 A	24 A
Torque	4.5 lb-in	0.4 Nm	4.5 lb-in	0.4 Nm	4.5 lb-in	0.4 Nm	4.5 lb-in	0.4 Nm
Insulation Material	Polyamide 66		Polyamide 66		Polyamide 66		Polyamide 66	

**Installation Instructions**

Wire Stripping Length	9 mm		9 mm		9 mm		9 mm	
Screwdriver	Flat Head 0.5 x 3.0 mm		Flat Head 0.5 x 3.0 mm		Flat Head 0.5 x 3.0 mm		Flat Head 0.6 x 3.5 mm	

**Terminal Blocks**

	Cat. No.	Std. Pk.	Cat. No.	Std. Pk.	Cat. No.	Std. Pk.	Cat. No.	Std. Pk.
<b>Grey</b>					<b>CTL2.5UH(I.S)D2</b>	<b>50</b>	<b>CTLG2.5</b>	<b>100</b>
<b>LED Voltage 12 V</b>	CTL2.5U-H(L)/12	50	CTL2.5U(L)/12	50			Yellow/Green	
<b>LED Voltage 24 V</b>	<b>CTL2.5U-H(L)/24</b>	50	<b>CTL2.5U(L)/24</b>	50				
<b>LED Voltage 48 V</b>	CTL2.5U-H(L)/48	50	CTL2.5U(L)/48	50				
<b>LED Voltage 110 V</b>	<b>CTL2.5U-H(L)/110</b>	50	<b>CTL2.5U(L)/110</b>	50				
<b>LED Voltage 220 V</b>	CTL2.5U-H(L)/220	50	CTL2.5U(L)/220	50				

**Accessories**

	Cat. No.	Std. Pk.	Cat. No.	Std. Pk.	Cat. No.	Std. Pk.	Cat. No.	Std. Pk.
End Plate	EPCTL2.5U-H	50	EPCTL2.5U	50	EPCTL2.5U-H	50	EPCTLG2.5	50
DIN Rail	2511120	20	2511120	20	2511120	20	2511120	20
	CA701-15/S	20	CA701-15/S	20	CA701-15/S	20	CA701-15/S	20
	2511160	10	2511160	10	2511160	10	2511160	10
End Stop	CA702	50	CA702	50	CA702	50	CA702	50
	CA802	50	CA802	50	CA802	50	CA802	50
	CA202	25	CA202	25	CA202	25	CA202	25
Internal Jumper	CA722/2	100	CA722/2	100	CA722/2	100	CA627/2	100
	CA722/3	100	CA722/3	100	CA722/3	100	CA627/3	100
	CA722/4	100	CA722/4	100	CA722/4	100	CA627/4	100
	CA722/10	10	CA722/10	10	CA722/10	10	CA627/10	10
	CA722/100	10	CA722/100	10	CA722/100	10	-	-
External Jumper	CA715/2	100	CA715/2	100	CA715/2	100	CA715/2	100
	CA715/3	100	CA715/3	100	CA715/3	100	CA715/3	100
	CA715/4	100	CA715/4	100	CA715/4	100	CA715/4	100
	CA715/10	20	CA715/10	20	CA715/10	20	CA715/10	20
Test Socket	CA707/TS/01	100	CA707/TS/01	100	CA707/TS/01	100	CA707/TS/01	100
Marking Tag	MT2	1 Pk. (100 tags)	MT2	1 Pk. (100 tags)	MT2	1 Pk. (100 tags)	MT2G	1 Pk. (100 tags)



### HIGHLIGHTS

#### FEATURES

- Yellow/Green color code as per industry standard
- Clamp mechanically on Rail by tightening middle screw
- Rail serves as grounding busbar to feed ground potential to all other grounding terminals
- **CGT4N, CGT6N, CGT10N and CGT16N** have same profile as respective feed through blocks
- **CGT4U, CGT10U, and CGT35U** mount on both 35mm and 32mm DIN-Rail

#### APPLICATIONS

- Grounding Applications

**CGT4U**

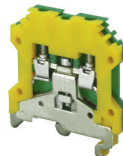

**CGT4N**



**CGT6N**



#### Dimensions & Weight

	<b>6 mm</b>	<b>6 mm</b>	<b>8 mm</b>
Width	6 mm	6 mm	8 mm
Length	43 mm	54.2 mm	54.5 mm
Height w DIN Rail	35 x 7.5 mm 35 x 15 mm	49.5 mm 56.7 mm	47.0 mm 54.4 mm
Weight per piece	21.5 g	22.0 g	27.0 g

#### Technical Data/Ratings

Approvals						
Wire Size (solid / stranded)	<b>22-10 AWG</b>		<b>22-10 AWG</b>		<b>22-8 AWG</b>	
Voltage Rating	600V		600V		600V	
Current Rating	-		-		-	
Torque	7.0 lb-in 0.5 Nm		7 lb-in 0.5 Nm		14 lb-in 1.6 Nm	
Insulation Material	Polyamide 66		Polyamide 66		Polyamide 66	

#### Installation Instructions

Wire Stripping Length	8 mm	8 mm	9 mm
Screwdriver	Flat Head 0.6 x 3.5 mm	Flat Head 0.6 x 3.5 mm	Flat Head 0.8 x 4.0 mm

#### Terminal Blocks

	Cat. No.	Std. Pk.	Cat. No.	Std. Pk.	Cat. No.	Std. Pk.
Yellow/Green	<b>CGT4U</b>	50	<b>CGT4N</b>	50	<b>CGT6N</b>	50

#### Accessories

	Cat. No.	Std. Pk.	Cat. No.	Std. Pk.	Cat. No.	Std. Pk.
End Plate	EPCGT4U/Y	50	-	-	-	-
DIN Rail	2511120 CA701-15/S 2511160	20 20 10	2511120 CA701-15/S 2511160	20 20 10	2511120 CA701-15/S 2511160	20 20 10
Marking Tag	MT6	1 Pk. (100 tags)	MT6	1 Pk. (100 tags)	MT8	1 Pk. (100 tags)

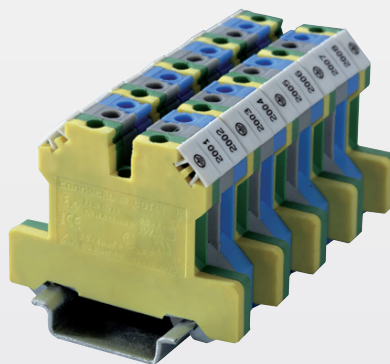

Assembly example for single phase 3 wire circuits.

**CGT10U**



**CGT10N**

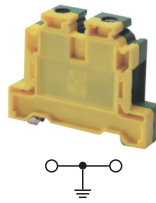

**CGT16N**

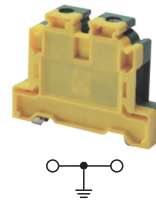

**CGT35U**



**Dimensions & Weight**

Width	<b>10 mm</b>	<b>10 mm</b>	<b>12 mm</b>	<b>16 mm</b>
Length	45.0 mm	55.0 mm	55.0 mm	58.0 mm
Height w DIN Rail	35 x 7.5 mm 35 x 15 mm	51.0 mm 58.2 mm	48.5 mm 56.0 mm	63.7 mm 70.5 mm
Weight per piece	30.5 g	35.2 g	39.6 g	102.0 g

**Technical Data/Ratings**

Approvals 												
Wire Size (solid / stranded)	<b>16-8 AWG</b>	22-6 AWG	0.2-10 mm <sup>2</sup>	<b>16-6 AWG</b>	22-6 AWG	0.2-10 mm <sup>2</sup>	<b>20-4 AWG</b>	22-6 AWG	0.2-16 mm <sup>2</sup>	<b>8-2 AWG</b>	22-6 AWG	2.5-35 mm <sup>2</sup>
Voltage Rating	600 V	600 V	1000 VAC/DC	600 V	600 V	1000 VAC/DC	600 V	600 V	1000 VAC/DC	600 V	600 V	1000 VAC/DC
Current Rating	-			-			-			-		
Torque	14 lb-in	14 lb-in	1.6 Nm	14 lb-in	14 lb-in	1.6 Nm	14 lb-in	14 lb-in	1.6 Nm	25 lb-in	25 lb-in	2.8 Nm
Insulation Material	Polyamide 66			Polyamide 66			Polyamide 66			Polyamide 66		

**Installation Instructions**

Wire Stripping Length	11 mm	11 mm	12 mm	15 mm
Screwdriver	Flat Head 0.8 x 4.0 mm	Flat Head 0.8 x 4.0 mm	Flat Head 1.0 x 5.5 mm	Flat Head 1.0 x 5.5 mm

**Terminal Blocks**

	Cat. No.	Std. Pk.	Cat. No.	Std. Pk.	Cat. No.	Std. Pk.	Cat. No.	Std. Pk.
Yellow/Green	<b>CGT10U</b>	50	<b>CGT10N</b>	50	<b>CGT16N</b>	50	<b>CGT35U</b>	20

**Accessories**

End Plate	-	-	-	-	-	-	-	-
DIN Rail	2511120	20	2511120	20	2511120	20	2511120	20
	CA701-15/S	20	CA701-15/S	20	CA701-15/S	20	CA701-15/S	20
	2511160	10	2511160	10	2511160	10	2511160	10
Marking Tag	MT10	1 Pk. (100 tags)	MT10	1 Pk. (100 tags)	MT12	1 Pk. (100 tags)	MT16	1 Pk. (100 tags)

# FUSE BLOCKS

SCREW TERMINAL BLOCKS

FUSE BLOCKS, 5 x 20 and 5 x 25 mm

## HIGHLIGHTS

### FEATURES

- CF4U Series accepts 5x20mm/ 5x25mm fuse types
- Completely enclosed, no endplates
- CF4U(L) version with LED for blown fuse indication
- Large marking area
- No polarity required
- Blocks can be used for AC & DC Voltages

### APPLICATIONS

- Control systems with fuse protection

### CF4U

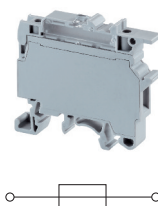

### CF4U(L)/6-60V

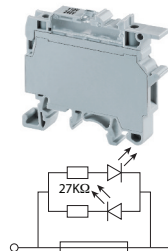

### CF4U(L)/110-240V

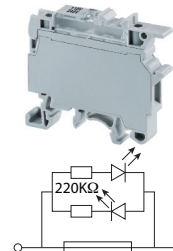

### Dimensions & Weight

Width	8 mm	8 mm	8 mm
Length	57.0 mm	57.0 mm	57.0 mm
Height w DIN Rail	35 x 7.5 mm 35 x 15 mm	50.3 mm 57.6 mm	50.3 mm 57.6 mm
Weight per piece	14.8 g	15.4 g	15.4 g

### Technical Data/Ratings

Approvals						
Wire Size (solid / stranded)	22-10 AWG		0.2-4 mm <sup>2</sup>		22-10 AWG	
Voltage Rating	600 V		800 V AC/DC		600 V	
Current Rating	10 A		6.3 A		10 A	
Torque	7 lb-in		0.5 Nm		7 lb-in	
Insulation Material	Polyamide 66					

### Fuse Specifications

Fuse Type	5x20 mm / 5 x 25 mm	5x20 mm / 5 x 25 mm	5x20 mm / 5 x 25 mm
LED Indicator Voltage	-	6-60V AC/DC	110-240V AC/DC

### Installation Instructions

Wire Stripping Length	9.5 mm	9.5 mm	9.5 mm
Screwdriver	Flat Head 0.6 x 3.5 mm	Flat Head 0.6 x 3.5 mm	Flat Head 0.6 x 3.5 mm

### Terminal Blocks

	Cat. No.	Std. Pk.	Cat. No.	Std. Pk.	Cat. No.	Std. Pk.
<b>Grey (standard)</b>	<b>CF4U</b>	50	<b>CF4U(L)/6-60V</b>	50	<b>CF4U(L)/110-240V</b>	50
Blue BU	CF4U/BU	50	CF4U(L)/6-60V/BU	50	CF4U(L)/110-240V/BU	50
Black BL	CF4U/BL	50	CF4U(L)/6-60V/BL	50	CF4U(L)/110-240V/BL	50

### Accessories

	Cat. No.	Std. Pk.	Cat. No.	Std. Pk.	Cat. No.	Std. Pk.
DIN Rail	2511120	20	2511120	20	2511120	20
	CA701-15/S	20	CA701-15/S	20	CA701-15/S	20
	2511160	10	2511160	10	2511160	10
External Jumper	CA711/2	100	CA711/2	100	CA711/2	100
	CA711/3	50	CA711/3	50	CA711/3	50
	CA711/4	50	CA711/4	50	CA711/4	50
	CA711/10	20	CA711/10	20	CA711/10	20
Marking Tag	MT8	1 Pk. (100 tags)	MT8	1 Pk. (100 tags)	MT8	1 Pk. (100 tags)
On Terminal	MT6	1 Pk. (100 tags)	MT6	1 Pk. (100 tags)	MT6	1 Pk. (100 tags)
On Fuse Carrier						

### Fuses 5 x 20 mm



Current Rating	Slow Blow Cat. No	Fast Blow Cat. No
0.1A	0.1M5x20T	0.1M5x20F
0.2A	0.2M5x20T	0.2M5x20F
0.5A	0.5M5x20T	0.5M5x20F
1.0A	1.0M5x20T	1.0M5x20F
2.0A	2.0M5x20T	2.0M5x20F
4.0A	4.0M5x20T	4.0M5x20F
5.0A	5.0M5x20T	5.0M5x20F
6.3A	6.3M5x20T	6.3M5x20F
8.0A	8.0M5x20T	8.0M5x20F
10.0A	10.0M5x20T	10.0M5x20F

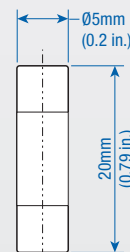

**CF4SP**

**CF4SP(L)/6-60V**

**CF4SP(L)/110-240V**

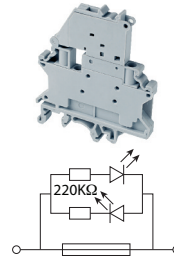
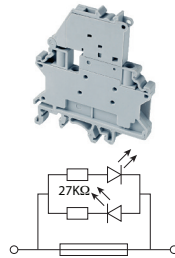
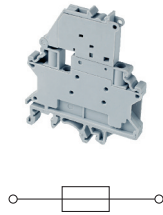

**Dimensions & Weight**

Width	6 mm	
Length	58.5 mm	
Height w/ DIN Rail	35 x 7.5 mm	35 x 15 mm
	70.0 mm	77.5 mm
Weight per piece	16.9 g	17.4 g

**Technical Data/Ratings**

Approvals		
Wire Size (solid / stranded)	24-10 AWG	0.2-4 mm <sup>2</sup>
Voltage Rating	600 V	1000 V AC/DC
Current Rating	10 A	10 A
Torque	4.5 lb-in	0.5 Nm
Insulation Material	Polyamide 66	

**Fuse Specifications**

Fuse Type	5x20 mm / 5 x 25 mm
LED Indicator Voltage	-

**Installation Instructions**

Wire Stripping Length	8 mm
Screwdriver	Flat Head 0.6 x 3.5 mm

**Terminal Blocks**

<b>Grey (standard)</b>	Cat. No.	Std. Pk.	Cat. No.	Std. Pk.	Cat. No.	Std. Pk.
Blue BU	<b>CF4SP</b>	50	<b>CF4SP(L)/6-60V</b>	50	<b>CF4SP(L)/110-240V</b>	50
Black BL	CF4SP/BU	50	CF4SP(L)/6-60V/BU	50	CF4SP(L)/110-240V/BU50	
	CF4SP/BL	50	CF4SP(L)/6-60V/BL	50	CF4SP(L)/110-240V/BL50	

**Accessories**

DIN Rail	Cat. No.	Std. Pk.	Cat. No.	Std. Pk.	Cat. No.	Std. Pk.	
	2511120	20	2511120	20	2511120	20	
	CA701-15/S	20	CA701-15/S	20	CA701-15/S	20	
	2511160	10	2511160	10	2511160	10	
Internal Jumper	Cat. No.	Std. Pk.	Cat. No.	Std. Pk.	Cat. No.	Std. Pk.	
	2 pole CA722/2	100	2 pole CA722/2	100	2 pole CA722/2	100	
	3 pole CA722/3	100	3 pole CA722/3	100	3 pole CA722/3	100	
	4 pole CA722/4	100	4 pole CA722/4	100	4 pole CA722/4	100	
	10 pole CA722/10	10	10 pole CA722/10	10	10 pole CA722/10	10	
	100 pole CA722/100	10	100 pole CA722/100	10	100 pole CA722/100	10	
Insulated Internal Jumper	Cat. No.	Std. Pk.	Cat. No.	Std. Pk.	Cat. No.	Std. Pk.	
	2 pole CA742/2	100	2 pole CA742/2	100	2 pole CA742/2	100	
	3 pole CA742/3	100	3 pole CA742/3	100	3 pole CA742/3	100	
	4 pole CA742/4	100	4 pole CA742/4	100	4 pole CA742/4	100	
	10 pole CA742/10	10	10 pole CA742/10	10	10 pole CA742/10	10	
	100 pole CA742/100	10	100 pole CA742/100	10	100 pole CA742/100	10	
External Jumper	Cat. No.	Std. Pk.	Cat. No.	Std. Pk.	Cat. No.	Std. Pk.	
	2 pole CA714/2	100	2 pole CA714/2	100	2 pole CA714/2	100	
	3 pole CA714/3	100	3 pole CA714/3	100	3 pole CA714/3	100	
	4 pole CA714/4	100	4 pole CA714/4	100	4 pole CA714/4	100	
	10 pole CA714/10	20	10 pole CA714/10	20	10 pole CA714/10	20	
	Marking Tag	On Terminal	MT6	1 Pk. (100 tags)	MT6	1 Pk. (100 tags)	MT6
	On Fuse Carrier	MT6	1 Pk. (100 tags)	MT6	1 Pk. (100 tags)	MT6	1 Pk. (100 tags)

**HIGHLIGHTS**

**FEATURES**

- CF4SP Series accepts 5x20mm fuse types
- 6mm wide, compact design
- Internal shorting channel
- Completely enclosed, no endplates
- CF4SP(L) version with LED for blown fuse indication
- No polarity required

**APPLICATIONS**

- Control systems with fuse protection
- Control Circuits with alternating configuration with (CF4SPFT, CKT4SP, etc...)

**CF4SPFT**

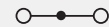
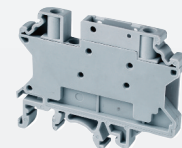

Feed Through Terminal  
Same Profile as CF4SP

**Technical Data/Ratings**

24-10 AWG	0.2-4 mm <sup>2</sup>
600 V	1000 V
30 A	32 A
4.5 lb-in	0.5 Nm
Polyamide 66	



# FUSE BLOCKS

SCREW TERMINAL BLOCKS

## DOUBLE LEVEL FUSE BLOCKS, 5 x 20 / 5 x 25 mm

### HIGHLIGHTS

#### FEATURES

- Top Level fuse link for 5x20mm/ 5x25mm fuse types
- Bottom Level Feed through terminal
- **DDFL4U(E)** version with LED for blown fuse indication in various voltages
- Blocks can be used in AC & DC applications

#### APPLICATIONS

- Tight space fuse applications
- No need for additional Feed through terminal

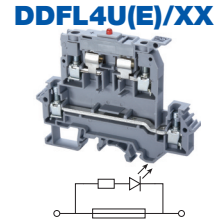
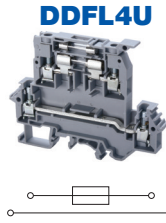

#### Dimensions & Weight

Width	8 mm	
Length	88 mm	
Height w DIN Rail	35 x 7.5 mm 35 x 15 mm	67.4 mm 74.3 mm
Weight per piece	28.0 g	

#### Technical Data/Ratings

Approvals				
Wire Size (solid / stranded)	22-10 AWG		0.2-4 mm <sup>2</sup>	
Voltage Rating	600 V		800 V AC/DC	
Current Rating (top)	6.3 A		6.3 A	
Current Rating (bottom)	35 A		32 A	
Torque	7 lb-in		0.5 Nm	
Insulation Material	Polyamide 66			

#### Fuse Specifications

Fuse Type	5x20 mm / 5 x 25 mm	5x20 mm / 5 x 25 mm
LED Indicator Voltage	-	24V, 48V, 110V, 220V, 440V

#### Installation Instructions

Wire Stripping Length	9.5 mm	9.5 mm
Screwdriver	Flat Head 0.6 x 3.5 mm	Flat Head 0.6 x 3.5 mm

#### Terminal Blocks

	Cat. No.	Std. Pk.	Cat. No.	Std. Pk.
<b>Grey</b>	<b>DDFL4U</b>	20	<b>DDFL4U(E)/24</b>	20
<b>LED Voltage 24V AC/DC</b>			<b>DDFL4U(E)/48</b>	20
<b>LED Voltage 48V AC/DC</b>			<b>DDFL4U(E)/110</b>	20
<b>LED Voltage 110V AC/DC</b>			<b>DDFL4U(E)/220</b>	20
<b>LED Voltage 220V AC/DC</b>			<b>DDFL4U(E)/440</b>	20
<b>LED Voltage 440V AC</b>				

#### Accessories

	Cat. No.	Std. Pk.	Cat. No.	Std. Pk.
End Plate	EPDDL4U	50	EPDDL4U	50
DIN Rail	2511120 CA701-15/S 2511160	20 20 10	2511120 CA701-15/S 2511160	20 20 10
End Stop	CA702 CA802 CA202	50 50 25	CA702 CA802 CA202	50 50 25
Internal Jumper	CA729/2 CA729/3 CA729/4 CA729/10	100 50 50 10	CA729/2 CA729/3 CA729/4 CA729/10	100 50 50 10
Insulated Internal Jumper	CA749/2 CA749/3 CA749/4 CA749/10	100 50 50 10	CA749/2 CA749/3 CA749/4 CA749/10	100 50 50 10
External Jumper	CA711/2 CA711/3 CA711/4 CA711/10	100 50 50 20	CA711/2 CA711/3 CA711/4 CA711/10	100 50 50 20
Marking Tag	MT8 MT2	1 Pk. (100 tags) 1 Pk. (100 tags)	MT8 MT2	1 Pk. (100 tags) 1 Pk. (100 tags)

DOUBLE LEVEL FUSE BLOCKS, 5 x 20 / 5 x 25 mm  
WITH 2 CONNECTION POINTS

### DDFL4ULR

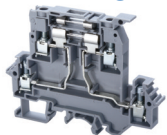

### DDFL4U(E)LR/XX

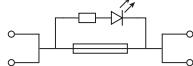
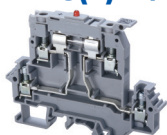

### Dimensions & Weight

Width	8 mm	8 mm
Length	88 mm	88 mm
Height w DIN Rail	35 x 7.5 mm 35 x 15 mm	67.4 mm 74.3 mm
Weight per piece	24.5 g	27.0 g

### Technical Data/Ratings

Approvals				
Wire Size (solid / stranded)	22-10 AWG	0.2-4 mm <sup>2</sup>	22-10 AWG	0.2-4 mm <sup>2</sup>
Voltage Rating	600 V	800 V AC/DC	600 V	800 V AC/DC
Current Rating (top)	6.3 A	6.3 A	6.3 A	6.3 A
Torque	7 lb-in	0.5 Nm	7 lb-in	0.5 Nm
Insulation Material	Polyamide 66		Polyamide 66	

### Fuse Specifications

Fuse Type	5x20 mm / 5 x 25 mm	5x20 mm / 5 x 25 mm
LED Indicator Voltage	-	24V, 48V, 110V, 220V, 440V

### Installation Instructions

Wire Stripping Length	9.5 mm	9.5 mm
Screwdriver	Flat Head 0.6 x 3.5 mm	Flat Head 0.6 x 3.5 mm

### Terminal Blocks

	Cat. No.	Std. Pk.	Cat. No.	Std. Pk.
<b>Grey</b> LED Voltage 24V AC/DC LED Voltage 48V AC/DC LED Voltage 110V AC/DC LED Voltage 220V AC/DC LED Voltage 440V AC	<b>DDFL4ULR</b>	20	<b>DDFL4U(E)LR/24</b>	20
			<b>DDFL4U(E)LR/48</b>	20
			<b>DDFL4U(E)LR/110</b>	20
			<b>DDFL4U(E)LR/220</b>	20
			<b>DDFL4U(E)LR/440</b>	20

### Accessories

	Cat. No.	Std. Pk.	Cat. No.	Std. Pk.	
End Plate	EPDDL4U	50	EPDDL4U	50	
DIN Rail	2511120	20	2511120	20	
	CA701-15/S	20	CA701-15/S	20	
	2511160	10	2511160	10	
End Stop	CA702	50	CA702	50	
	CA802	50	CA802	50	
	CA202	25	CA202	25	
Internal Jumper	2 pole	CA729/2	100	CA729/2	100
	3 pole	CA729/3	50	CA729/3	50
	4 pole	CA729/4	50	CA729/4	50
	10 pole	CA729/10	10	CA729/10	10
	Insulated Internal Jumper	2 pole	CA749/2	100	CA749/2
3 pole		CA749/3	50	CA749/3	50
4 pole		CA749/4	50	CA749/4	50
10 pole		CA749/10	10	CA749/10	10
External Jumper		2 pole	CA711/2	100	CA711/2
	3 pole	CA711/3	50	CA711/3	50
	4 pole	CA711/4	50	CA711/4	50
	10 pole	CA711/10	20	CA711/10	20
	Marking Tag	on terminal	MT8	1 Pk. (100 tags)	MT8
on lever		MT2	1 Pk. (100 tags)	MT2	1 Pk. (100 tags)

## HIGHLIGHTS

### FEATURES

- Modified version of **DDFL4U** with 2 equipotential
- **DDFL4U(E)** version with LED for blown fuse indication in various voltages
- Blocks can be used in AC & DC applications

### APPLICATIONS

- Control Circuits with multi wire fuse application

# FUSE BLOCKS

SCREW TERMINAL BLOCKS

FUSE BLOCKS, 1/4 x 1 and 1/4 x 1 1/4 in.

## HIGHLIGHTS

### FEATURES

- **CAFL4U** Series accepts 1/4" x 1-1/4" (6.3x32mm) fuse types
- **CAFL4U(L)** versions with LED for blown fuse indication (24V, 48V, 110V, 220V)
- **CAFL4U(N)** version with Neon bulb for blown fuse indication
- Large marking area
- Blocks can be used in AC & DC applications

### APPLICATIONS

- Control systems with 1/4" x 1-1/4" fuse protection

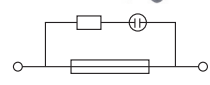
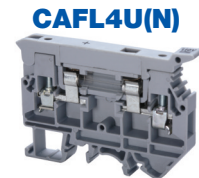
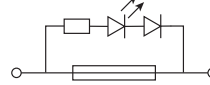
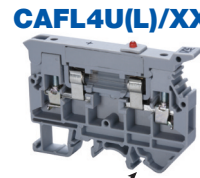
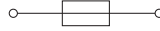
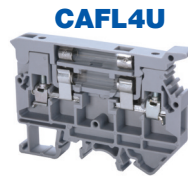

### Dimensions & Weight

	CAFL4U	CAFL4U(L)/XX	CAFL4U(N)
Width	9 mm	9 mm	9 mm
Length	72 mm	72 mm	72 mm
Height w/ DIN Rail	35 x 7.5 mm 35 x 15 mm	55.3 mm 63.0 mm	55.3 mm 63.0 mm
Weight per piece	20.5 g	20.5 g	20.5 g

### Technical Data/Ratings

Approvals	CAFL4U		CAFL4U(L)/XX		CAFL4U(N)	
	UL E220514	IEC 60947-7-3	UL E220514	IEC 60947-7-3	UL E220514	IEC 60947-7-3
Wire Size (solid / stranded)	22-10 AWG	0.2-4 mm <sup>2</sup>	22-10 AWG	0.2-4 mm <sup>2</sup>	22-10 AWG	0.2-4 mm <sup>2</sup>
Voltage Rating	600 V	1000 V	600 V	1000 V	600 V	1000 V
Current Rating	16 A	6.3 A	16 A	6.3 A	16 A	6.3 A
Torque	7 lb-in	0.5 Nm	7 lb-in	0.5 Nm	7 lb-in	0.5 Nm
Insulation Material	Polyamide 66		Polyamide 66		Polyamide 66	

### Installation Instructions

	CAFL4U	CAFL4U(L)/XX	CAFL4U(N)
Wire Stripping Length	9.5 mm	9.5 mm	9.5 mm
Screwdriver	Flat Head 0.6 x 3.5 mm	Flat Head 0.6 x 3.5 mm	Flat Head 0.6 x 3.5 mm

### Fuse Specifications

	CAFL4U	CAFL4U(L)/XX	CAFL4U(N)
Fuse Type	1/4" x 1" (6.3 x 32 mm)	1/4" x 1" (6.3 x 32 mm)	1/4" x 1" (6.3 x 32 mm)
LED/Neon Indicator Voltage	-	24V, 48V, 110V, 220V	110V - 240V

### Terminal Blocks

	Cat. No.	Std. Pk.	Cat. No.	Std. Pk.	Cat. No.	Std. Pk.
<b>Grey (standard)</b>	<b>CAFL4U</b>	25	-	-	-	-
Blue BU	CAFL4U/BU	25	-	-	-	-
Black BL	CAFL4U/BL	25	-	-	-	-
LED Voltage 24V AC/DC	-	-	<b>CAFL4U(L)/24</b>	25	-	-
LED Voltage 48V AC/DC	-	-	<b>CAFL4U(L)/48</b>	25	-	-
LED Voltage 110V AC/DC	-	-	<b>CAFL4U(L)/110</b>	25	-	-
LED Voltage 220V AC/DC	-	-	<b>CAFL4U(L)/220</b>	25	-	-
Neon Bulb 110-300V AC/DC	-	-	-	-	<b>CAFL4U(N)</b>	25

### Accessories

	Cat. No.	Std. Pk.	Cat. No.	Std. Pk.	Cat. No.	Std. Pk.
End Plate	EPCAF4U	50	EPCAF4U	50	EPCAF4U	50
DIN Rail	2511120	20	2511120	20	2511120	20
	CA701-15/S	20	CA701-15/S	20	CA701-15/S	20
	2511160	10	2511160	10	2511160	10
End Stop	CA702	50	CA702	50	CA702	50
	CA802	50	CA802	50	CA802	50
	CA202	25	CA202	25	CA202	25
External Jumper	CA716/2	50	CA716/2	50	CA716/2	50
	CA716/3	50	CA716/3	50	CA716/3	50
	CA716/4	50	CA716/4	50	CA716/4	50
	CA716/10	20	CA716/10	20	CA716/10	20
Marking Tag	MT9	1 Pk. (100 tags)	MT9	1 Pk. (100 tags)	MT9	1 Pk. (100 tags)

### Fuses 1/4" x 1-1/4" (6.3 x 32mm)



Current Rating	Slow Blow Cat. No	Fast Blow Cat. No	Current Rating	Slow Blow Cat. No	Fast Blow Cat. No
0.1A	0.1M6.3x32T	0.1M6x32F	4.0A	4.0M6.3x32T	4.0M6x32F
0.2A	0.2M6.3x32T	0.2M6x32F	5.0A	5.0M6.3x32T	5.0M6x32F
0.5A	0.5M6.3x32T	0.5M6x32F	6.3A	6.3M6.3x32T	6.3M6x32F
1.0A	1.0M6.3x32T	1.0M6x32F	8.0A	8.0M6.3x32T	8.0M6x32F
2.0A	2.0M6.3x32T	2.0M6x32F	10.0A	10.0M6.3x32T	10.0M6x32F

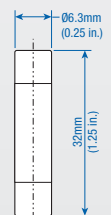

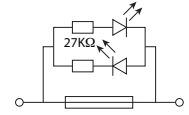
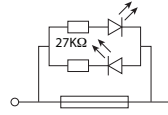
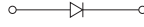
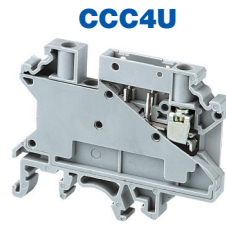

**Dimensions**

Width	<b>6 mm</b>	<b>6 mm</b>	<b>6 mm</b>	<b>6 mm</b>
Length	58.5 mm	28 mm	28 mm	28 mm
Height w DIN Rail	35 x 7.5 mm 35 x 15 mm	46 mm 53.5 mm	35 mm	35 mm
Weight per piece	10.2 g	3.8 g	3.8 g	4.2 g

**Technical Data/Ratings**

Approvals							
Wire Size (solid   stranded)	0.2-6 mm <sup>2</sup>   0.2-4 mm <sup>2</sup>	<b>24-10 AWG</b>   0.2-4 mm <sup>2</sup>	0.2-4 mm <sup>2</sup>	<b>24-10 AWG</b>   0.2-4 mm <sup>2</sup>	0.2-4 mm <sup>2</sup>	<b>24-10 AWG</b>   0.2-4 mm <sup>2</sup>	0.2-4 mm <sup>2</sup>
Voltage Rating	1000 V AC/DC	600 V   1000V AC/DC	1000V AC/DC	600 V   1000V AC/DC	1000V AC/DC	600 V   1000V AC/DC	1000V AC/DC
Current Rating	*	1 A   1 A	1 A	10 A   10 A	10 A	10 A   10 A	10 A
Insulation Material	Polyamide 66	Polyamide 66	Polyamide 66	Polyamide 66	Polyamide 66	Polyamide 66	Polyamide 66

**Carrier Specifications**

Component Type	<b>Component carrier base</b>	<b>Plug module with diode Diode Type IN4007</b>	<b>Plug module for 5x20 mm fuse</b>	<b>Plug module for 5x20 mm fuse with LED indicator</b>
LED Indicator Voltage	-	-	-	<b>6-60V AC/DC 110-240V AC/DC</b>

**Installation Instructions**

Wire Stripping Length	<b>8 mm</b>	<b>10 mm</b>	<b>10 mm</b>	<b>10 mm</b>
Screwdriver	Flat Head 0.6 x 3.5 mm	Flat Head 0.6 x 3.5 mm	Flat Head 0.6 x 3.5 mm	Flat Head 0.6 x 3.5 mm

**Terminal Blocks**

	Cat. No.	Std. Pk.	Cat. No.	Std. Pk.	Cat. No.	Std. Pk.	Cat. No.	Std. Pk.
<b>Grey (standard)</b>	<b>CCC4U</b>	<b>50</b>	<b>CPF</b>	<b>50</b>	<b>CPFL6-60V</b>	<b>50</b>	<b>CPFL110-240V</b>	<b>50</b>

**Accessories**

	Cat. No.	Std. Pk.	Cat. No.	Std. Pk.	Cat. No.	Std. Pk.	Cat. No.	Std. Pk.
DIN Rail	2511120 CA701-15/S	20 10	- -	- -	- -	- -	- -	- -
End Stop	CA702 CA802 CA103	50 50 50	- - -	- - -	- - -	- - -	- - -	- - -
Internal Jumpers	2 pole 3 pole 4 pole 10 pole 100 pole	CA722/2 CA722/3 CA722/4 CA722/10 CA722/100	100 100 100 10 10	- - - - -	- - - - -	- - - - -	- - - - -	- - - - -
Marking Tag	MT6	1 Pk. (100 tags)	MT6	1 Pk. (100 tags)	MT6	1 Pk. (100 tags)	MT6	1 Pk. (100 tags)

\* Current Rating is based on plug used.



### 10x38 Midget Fuse Holders



**UL**  
E212627

Pole Configuration	Without Indication	With LED Indication	Fuse Size	Max Voltage & Current		Drawing No.
				IEC	UL	
<b>PCF 10 &amp; PCF 10 LED</b>						
1-pole	002550001	002550011	10x38	690V AC / 32A	600V AC/DC / 30A	1
1-pole+N	002550002	002550012	10x38	690V AC / 32A	600V AC/DC / 30A	1
2-pole	002550003	002550013	10x38	690V AC / 32A	600V AC/DC / 30A	1
3-pole	002550004	002550014	10x38	690V AC / 32A	600V AC/DC / 30A	1
3-pole+N	002550005	002550015	10x38	690V AC / 32A	600V AC/DC / 30A	1
<b>EFD 10 &amp; EFD 10 LED</b>						
▶ 1-pole	002540001	002540011	10x38	690V AC/DC / 32A	600V AC/DC / 30A	2
▶ 1-pole+N	002540002	002540012	10x38	690V AC/DC / 32A	600V AC/DC / 30A	2
▶ 2-pole	002540003	002540013	10x38	690V AC/DC / 32A	600V AC/DC / 30A	2
▶ 3-pole	002540004	002540014	10x38	690V AC/DC / 32A	600V AC/DC / 30A	2
▶ 3-pole+N	002540005	002540015	10x38	690V AC/DC / 32A	600V AC/DC / 30A	2

### CC Type and J Type Fuse Holders



**UL**  
E212627

Pole Configuration	Without Indication	With LED Indication	Fuse Size	SCR	UL Rating Voltage/Amp.	Drawing No.
1-pole	002550101	002550111	CC Type	200 kA	600V AC/DC / 30A	1
2-pole	002550103	002550113	CC Type	200 kA	600V AC/DC / 30A	1
3-pole	002550104	002550114	CC Type	200 kA	600V AC/DC / 30A	1
<b>EFD CC &amp; EFD CC LED</b>						
▶ 1-pole	002540101	002540111	CC Type	200 kA	600V AC / 30A	2
▶ 2-pole	002540103	002540113	CC Type	200 kA	600V AC / 30A	2
▶ 3-pole	002540104	002540114	CC Type	200 kA	600V AC / 30A	2
<b>EFD J30 DC &amp; EFD J30 10 DC LED</b>						
▶ 1-pole	002570101	002570111	J-TYPE	200 kA	600V AC/DC / 30A	3
▶ 2-pole	002570103	002570113	J-TYPE	200 kA	600V AC/DC / 30A	3
▶ 3-pole	002570104	002570114	J-TYPE	200 kA	600V AC/DC / 30A	3

### PV Type Fuse Holders



**UL**  
E356295

Pole Configuration	Without Indication	With LED Indication	Fuse Size	Max Voltage & Current		Drawing No.
				IEC	UL	
<b>PCF 10 DC &amp; PCF 10 DC LED</b>						
1-pole	002550201	002550211	10x38	1000V DC / 25A	1000V DC / 25A	1
2-pole	002550203	002550213	10x38	1000V DC / 25A	1000V DC / 25A	1
<b>EFH 10 DC &amp; EFH 10 DC LED</b>						
▶ 1-pole	002540201	002540211	10x38	1000V DC / 25A	1000V DC / 25A	2
▶ 2-pole	002540203	002540213	10x38	1000V DC / 25A	1000V DC / 25A	2
<b>EFH 14 DC &amp; EFH 14 DC LED</b>						
▶ 1-pole	002560201	002560211	14x51	1000V DC / 50A	1000V DC / 50A	3
▶ 2-pole	002560203	002560213	14x51	1000V DC / 50A	1000V DC / 50A	3

### IEC Type Fuse Holders



**UL**  
E212627

Pole Configuration	Without Indication	With LED Indication	Fuse Size	Max Voltage & Current		Drawing No.
				IEC	UL	
<b>EFD 14 &amp; EFD 14 LED</b>						
▶ 1-pole	002560001	002560011	14x51	690V AC / 50A	600V AC/DC / 50A	3
▶ 1-pole+N	002560002	002560012	14x51	690V AC / 50A	600V AC/DC / 50A	3
▶ 2-pole	002560003	002560013	14x51	690V AC / 50A	600V AC/DC / 50A	3
▶ 3-pole	002560004	002560014	14x51	690V AC / 50A	600V AC/DC / 50A	3
▶ 3-pole+N	002560005	002560015	14x51	690V AC / 50A	600V AC/DC / 50A	3
<b>EFD 22 &amp; EFD 22 LED</b>						
▶ 1-pole	002570001	002570011	22x58	690V AC / 100A	600V AC/DC / 100A	4
▶ 1-pole+N	002570002	002570012	22x58	690V AC / 100A	600V AC/DC / 100A	4
▶ 2-pole	002570003	002570013	22x58	690V AC / 100A	600V AC/DC / 100A	4
▶ 3-pole	002570004	002570014	22x58	690V AC / 100A	600V AC/DC / 100A	4
▶ 3-pole+N	002570005	002570015	22x58	690V AC / 100A	600V AC/DC / 100A	4

## FUSE HOLDERS, 10 x 38 mm and CC Type

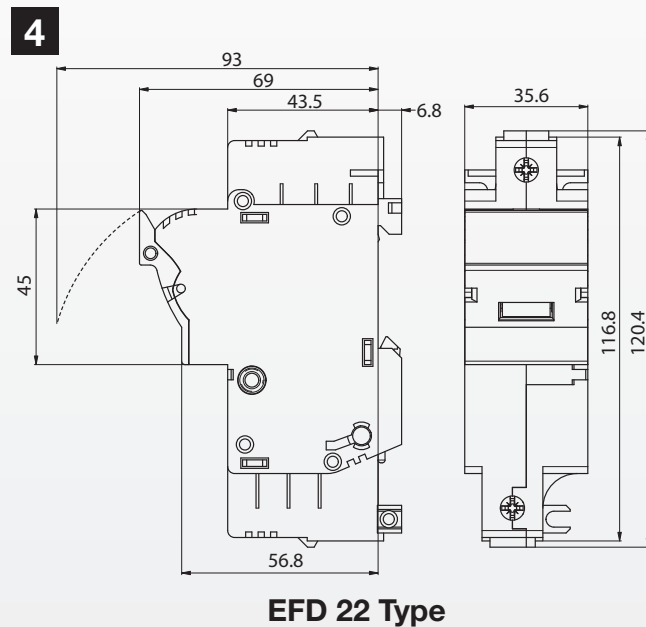
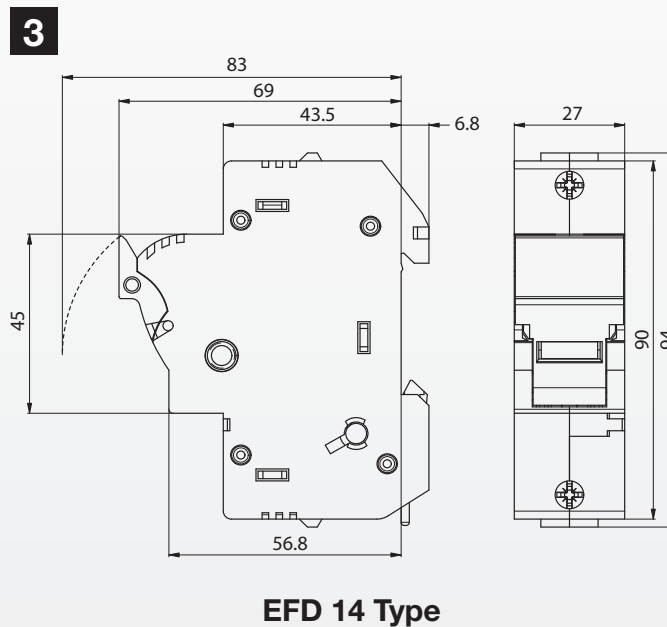
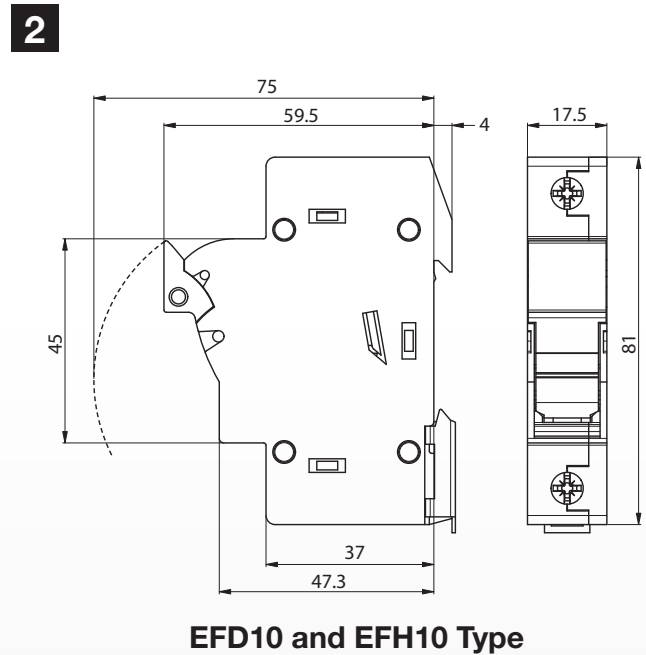
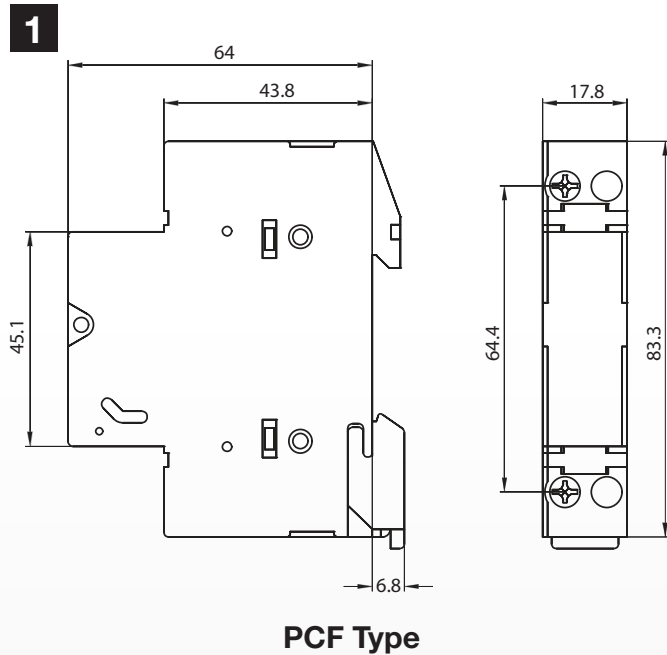

**NOTE:** All dimensions are shown in millimeters. To convert to inches multiply by 0.03937

### Accessories for The Modular Type PCF, EFD and EFH

Modular fuse holders have a unique user configurable feature. By using the modular snap kit (parts sold individually) a customer can configure any pole configuration by inserting the connecting element (3 per pole) into the slot in the side of the fuse holder and then pushing them together and inserting the connecting shaft into the handle.

**NOTE:** 1 kit suffices for the assembly of 50 sets.



#### 2 Pole Connection Kits

Model No.	Usable with
002540948	EFD 8, EFD 10, EFH 10, PCF 8, PCF 10, EFD CC, PCF CC
002560948	EFD 14, EFH 14
002570948	EFD 22, EFD J30

#### 3 Pole Connection Kits

Model No.	Usable with
002540949	EFD 8, EFD 10, PCF 8, PCF 10, EFD CC, PCF CC
002560949	EFD 14
002570949	EFD 22, EFD J30

### Auxiliary Switches

Model No.	Usable with	Type
002559001	PCF 10	1NO/1NC
002569001	EFD 14	1NO/1NC
002579001	EFD 22	1NO/1NC

For Auxiliary switches to operate, a fuse with striker pin must be used.



# DISCONNECT & TEST

## SCREW TERMINAL BLOCKS

## DISCONNECT AND TEST TERMINAL BLOCKS

### HIGHLIGHTS

#### FEATURES

- Slider Style Disconnect Terminals
  - **CDS6U** - Standard Slider Disconnect
  - **CDS6U/TS** - Slider Disconnect with integrated testing points
  - **CDS6U/FT** - Same profile Feed-Through
- Separate Testing points allow insertion of standard test probes
- Disconnect is achieved by operating sliding link with screw driver
- **SLS2, SLS4** slide shorting link system
- **QJ8/2** - Shorting Plug

#### APPLICATIONS

(see following page)

- Disconnect & Test Applications
- Measuring / Control Circuits
- Utility Instruments and Transformer Applications
- Meter Replacement
- External Current Measurement
- Switch Boards

### CDS6U

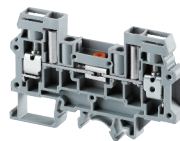

Slider Disconnect Terminal	<b>8 mm</b>
Width	<b>8 mm</b>
Length	82 mm
Height w DIN Rail	51.0 mm 59.2 mm
Weight per piece	33.8 g

### CDS6U/TS

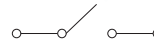
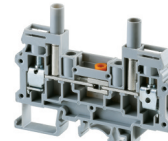

Slider Disconnect Terminal Including Test Sockets	<b>8 mm</b>
Width	<b>8 mm</b>
Length	82 mm
Height w DIN Rail	51.0 mm 59.2 mm
Weight per piece	33.8 g

### CDS6U/FT

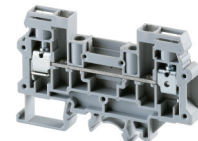

Feed Through Terminal with CDS6U profile	<b>6 mm</b>
Width	<b>6 mm</b>
Length	82 mm
Height w DIN Rail	51.0 mm 59.2 mm
Weight per piece	21.2 g

#### Dimensions & Weight

Width	<b>8 mm</b>
Length	82 mm
Height w DIN Rail	51.0 mm 59.2 mm
Weight per piece	33.8 g

#### Technical Data/Ratings

Approvals	CE, IEC, UL, Lloyd's Register
Wire Size (solid / stranded)	<b>22-8 AWG</b>
Voltage Rating	600 V
Current Rating	45 A
Torque	14 lb-in
Insulation Material	Polyamide 66

Approvals	UL, IEC, C-SP
Wire Size (solid / stranded)	<b>22-8 AWG</b>
Voltage Rating	600 V
Current Rating	45 A
Torque	14 lb-in
Insulation Material	Polyamide 66

Approvals	UL, IEC, C-SP
Wire Size (solid / stranded)	<b>22-8 AWG</b>
Voltage Rating	600 V
Current Rating	45 A
Torque	14 lb-in
Insulation Material	Polyamide 66

Approvals	UL, IEC, C-SP
Wire Size (solid / stranded)	<b>22-8 AWG</b>
Voltage Rating	600 V
Current Rating	45 A
Torque	14 lb-in
Insulation Material	Polyamide 66

#### Installation Instructions

Wire Stripping Length	10 mm
Screwdriver	Flat Head 0.8 x 4 mm

Wire Stripping Length	10 mm
Screwdriver	Flat Head 0.8 x 4 mm

Wire Stripping Length	10 mm
Screwdriver	Flat Head 0.8 x 4 mm

Wire Stripping Length	10 mm
Screwdriver	Flat Head 0.8 x 4 mm

#### Terminal Blocks

<b>Grey (standard)</b>	
Red	R
Blue	BU
Black	BL
Orange	O
Green	G
Yellow	Y
White	W

Cat. No.	Std. Pk.
<b>CDS6U</b>	50
CDS6U/R	50
CDS6U/BU	50
CDS6U/BL	50
CDS6U/O	50
CDS6U/G	50
CDS6U/Y	50
CDS6U/W	50

Cat. No.	Std. Pk.
<b>CDS6U/TS</b>	50
CDS6U/TS/R	50
CDS6U/TS/BU	50
CDS6U/TS/BL	50
CDS6U/TS/O	50
CDS6U/TS/G	50
CDS6U/TS/Y	50
CDS6U/TS/W	50

Cat. No.	Std. Pk.
<b>CDS6U/FT</b>	50
CDS6U/FT/R	50
CDS6U/FT/BU	50
CDS6U/FT/BL	50
CDS6U/FT/O	50
CDS6U/FT/G	50
CDS6U/FT/Y	50
CDS6U/FT/W	50

#### Accessories

End Plate		EPCDS6U	50
DIN Rail	32mm, 35mm	2511120	20
End Stop		CA702	50
Internal Jumper	2 pole, 3 pole, 4 pole, 10 pole	CA723/2	100
Slide Shorting Link	2 pole, 3 pole, 4 pole	SLS2	50
Insulated Test Socket	grey, red, yellow, blue, black	TPSLS	100
Lock Out Cap		LCCDS	50
Shorting Plug		QJ8/2	25
Marking Tag		MT6	1 Pk. (100 tags)

Cat. No.	Std. Pk.
EPCDS6U	50
2511120	20
CA701-15/S	20
2511160	10
CA702	50
CA802	50
CA202	25
CA723/2	100
CA723/3	50
CA723/4	50
CA723/10	10
SLS2	50
SLS3	25
SLS4	25
TPSLS	100
TPSLSR	100
TPSLSY	100
TPSLSBU	100
TPSLSBK	100
LCCDS	50
QJ8/2	25
MT6	1 Pk. (100 tags)

Cat. No.	Std. Pk.
EPCDS6U	50
2511120	20
CA701-15/S	20
2511160	10
CA702	50
CA802	50
CA202	25
CA723/2	100
CA723/3	50
CA723/4	50
CA723/10	10
SLS2	50
SLS3	25
SLS4	25
TPSLS	100
TPSLSR	100
TPSLSY	100
TPSLSBU	100
TPSLSBK	100
LCCDS	50
QJ8/2	25
MT6	1 Pk. (100 tags)

Cat. No.	Std. Pk.
EPCDS6U	50
2511120	20
CA701-15/S	20
2511160	10
CA702	50
CA802	50
CA202	25
CA723/2	100
CA723/3	50
CA723/4	50
CA723/10	10
SLS2	50
SLS3	25
SLS4	25
TPSLS	100
TPSLSR	100
TPSLSY	100
TPSLSBU	100
TPSLSBK	100
LCCDS	50
QJ8/2	25
MT8	1 Pk. (100 tags)

**Single Phase Current Transformer Test Circuit**

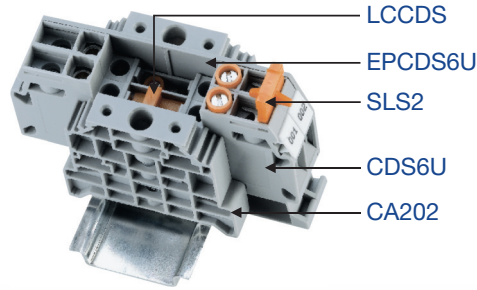

**3 Phase current Transformer Test Set**

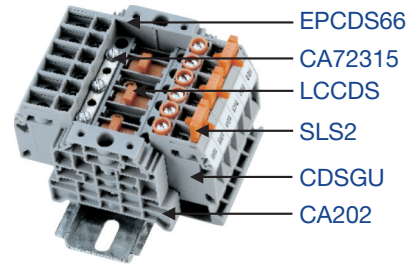

**Operating status**

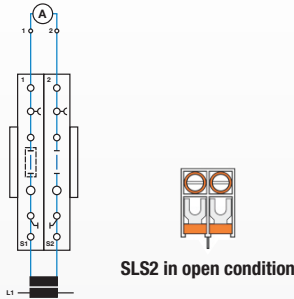

**Operating status**

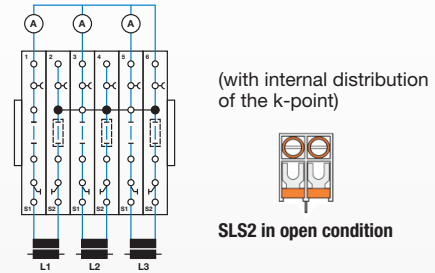

**Comparison measurement for L1**

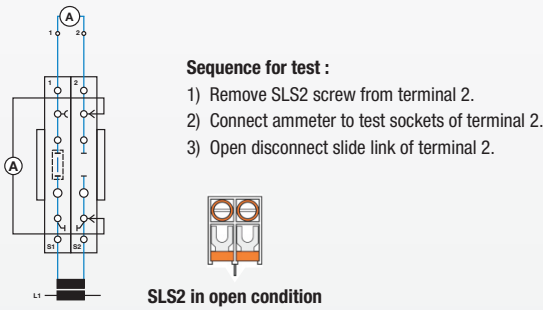

**Comparison measurement for L1**

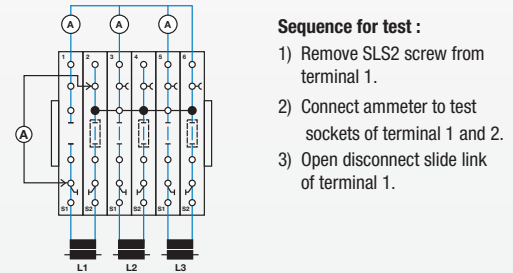

**Meter test for L1 through external power supply**

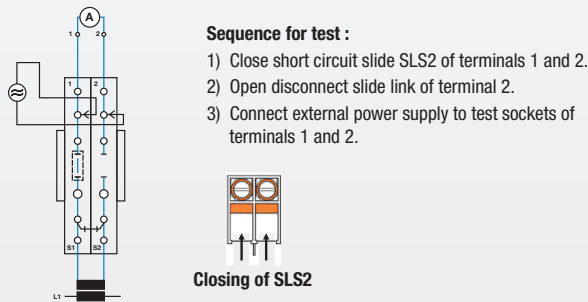

**Meter test for L1 through external power supply**

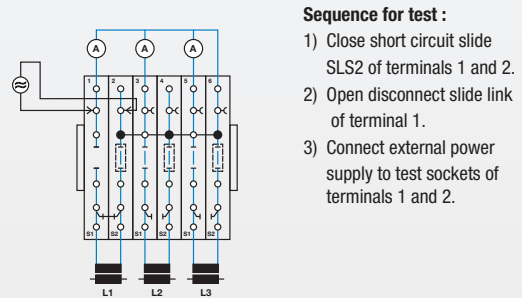

**Meter replacement**

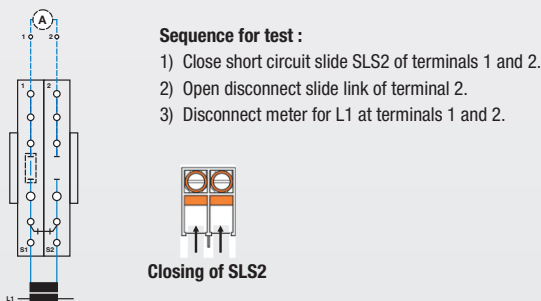

**Meter Replacement for L1**

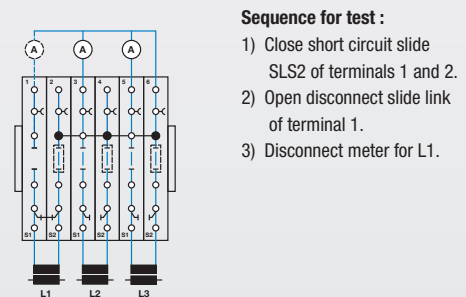

# DISCONNECT & TEST

SCREW TERMINAL BLOCKS

## BLADE/KNIFE STYLE DISCONNECT TERMINAL BLOCKS

### HIGHLIGHTS

#### FEATURES

- Knife / Blade Style Disconnect Terminals
  - **CKT4U** - Standard Knife Disconnect
  - **CKT4U/4** - 4 Connection Knife Disconnect
- Specially designed socket headed screws act as fast monitoring points

#### APPLICATIONS

- Disconnect & Test Applications

**CKT4U**



**CKT4U/4**

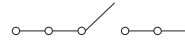
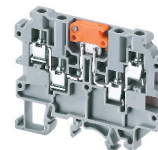

#### Dimensions & Weight

	Knife Style Disconnect 2 Connections	Knife Style Disconnect 4 Connections
<b>Width</b>	<b>6 mm</b>	<b>6 mm</b>
Length	46.3 mm	65.0 mm
Height w DIN Rail	48.3 mm 35 x 7.5 mm 56.0 mm 35 x 15 mm	54.3 mm 62.0 mm
Weight per piece	10.5 g	16.6 g

#### Technical Data/Ratings

Approvals					
Wire Size (solid / stranded)	22-10 AWG	22-10 AWG	0.2-4 mm <sup>2</sup>	<b>22-10 AWG</b>	0.2-4 mm <sup>2</sup>
Voltage Rating	600 V	600 V	800 V	600 V	800 V
Current Rating	35 A	16 A	28 A	20 A	17.5 A
Torque	7 lb-in	7 lb-in	0.5 Nm	7 lb-in	0.5 Nm
Insulation Material	Polyamide 66			Polyamide 66	

#### Installation Instructions

Wire Stripping Length	8 mm	8 mm
Screwdriver	Flat Head 0.6 x 3.5 mm	Flat Head 0.6 x 3.5 mm

#### Terminal Blocks

	Cat. No.	Std. Pk.	Cat. No.	Std. Pk.
<b>Grey (standard)</b>	<b>CKT4U</b>	50	<b>CKT4U/4</b>	50
Red R	CKT4U/R	50	CKT4U/4/R	50
Blue BU	CKT4U/BU	50	CKT4U/4/BU	50
Black BL	CKT4U/BL	50	CKT4U/4/BL	50
Orange O	CKT4U/O	50	CKT4U/4/O	50
Green G	CKT4U/G	50	CKT4U/4/G	50
Yellow Y	CKT4U/Y	50	CKT4U/4/Y	50
White W	CKT4U/W	50	CKT4U/4/W	50

#### Accessories

	Cat. No.	Std. Pk.	Cat. No.	Std. Pk.
End Plate	EPCKT4U	50	EPCKT4U/4	50
DIN Rail	2511120 CA701-15/S 2511160	20 20 10	2511120 CA701-15/S 2511160	20 20 10
End Stop	CA702 CA802 CA202	50 50 25	CA702 CA802 CA202	50 50 25
External Jumper	2 pole CA714/2 3 pole CA714/3 4 pole CA714/4 10 pole CA714/10	100 100 100 20	CA714/2* CA714/3* CA714/4* CA714/10*	100 100 100 20
Marking Tag	MT6	1 Pk. (100 tags)	MT6	1 Pk. (100 tags)

\* Insulated External shorting links can be used only in the upper level clamping unit of the Terminal Block.



**CKT4SP**

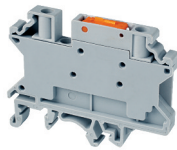

**CF4SPFT**

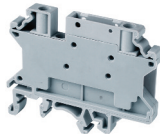

**CF4SP**

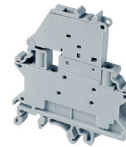

**HIGHLIGHTS**

**FEATURES**

- Knife Style Disconnect Terminal
- **CF4SPFT** same profile Feed Through Terminal
- **CF4SP** same profile as Fuse Terminal, 5 x 20 mm Fuse Types

**APPLICATIONS**

- Control Systems with Fuse Protection
- Fused Control Circuits with alternating configurations (CF4SP, CF4SPFT, CGT4SP)
- Switch Boards

**Dimensions & Weight**

	Knife Style Disconnect Same profile as CF4SP Fuse Block	Feed-Through Terminal Same profile as CF4SP Fuse Block	Fuse Block 5x20 mm Fuse Type
Width	6 mm	6 mm	8 mm
Length	58.5 mm	58.5 mm	57.0 mm
Height w DIN Rail 35 x 7.5 mm 35 x 15 mm	46.0 mm 53.5 mm	46.0 mm 53.5 mm	50.3 mm 57.6 mm
Weight per piece	27.2 g	g	16.9 g

**Technical Data/Ratings**

Approvals						
Wire Size (solid / stranded)	24-10 AWG	0.2-4 mm <sup>2</sup>	24-10 AWG	0.2-4 mm <sup>2</sup>	24-10 AWG	0.2-4 mm <sup>2</sup>
Voltage Rating	600 V	1000 V	600 V	1000 V	600 V	1000 V AC/DC
Current Rating	30 A	28 A	30 A	32 A	10 A	10 A
Torque	4.5 lb-in	0.5 Nm	4.5 lb-in	0.5 Nm	4.5 lb-in	0.5 Nm
Insulation Material	Polyamide 66		Polyamide 66		Polyamide 66	

**Installation Instructions**

Wire Stripping Length	8 mm	8 mm	8 mm
Screwdriver	Flat Head 0.6 x 3.5 mm	Flat Head 0.6 x 3.5 mm	Flat Head 0.6 x 3.5 mm

**Terminal Blocks**

	Cat. No.	Std. Pk.	Cat. No.	Std. Pk.	Cat. No.	Std. Pk.
<b>Grey (standard)</b>	<b>CKT4SP</b>	50	<b>CF4SPFT</b>	50	<b>CF4SP</b>	50
Red R	CKT4SP/R	50	CF4SPFT/R	50	CF4SP/BU	50
Blue BU	CKT4SP/BU	50	CF4SPFT/BU	50	CF4SP/BL	50
Black BL	CKT4SP/BL	50	CF4SPFT/BL	50		
Orange O	CKT4SP/O	50	CF4SPFT/O	50		
Green G	CKT4SP/G	50	CF4SPFT/G	50		
Yellow Y	CKT4SP/Y	50	CF4SPFT/Y	50		
White W	CKT4SP/W	50	CF4SPFT/W	50		

**Accessories**

	Cat. No.	Std. Pk.	Cat. No.	Std. Pk.	Cat. No.	Std. Pk.
DIN Rail 	2511120 CA701-15/S 2511160	20 20 10	2511120 CA701-15/S 2511160	20 20 10	2511120 CA701-15/S 2511160	20 20 10
End Stop 	CA702 CA802 CA202	50 50 25	CA702 CA802 CA202	50 50 25	- - -	- - -
Internal Jumper 	CA722/2 CA722/3 CA722/4 CA722/10 CA722/100	100 100 100 10 10	CA722/2 CA722/3 CA722/4 CA722/10 CA722/100	100 100 100 10 10	CA722/2 CA722/3 CA722/4 CA722/10 CA722/100	100 100 100 10 10
Insulated Internal Jumper 	CA742/2 CA742/3 CA742/4 CA742/10 CA742/100	100 100 100 10 10	CA742/2 CA742/3 CA742/4 CA742/10 CA742/100	100 100 100 10 10	CA742/2 CA742/3 CA742/4 CA742/10 CA742/100	100 100 100 10 10
External Jumper 	CA714/2 CA714/3 CA714/4 CA714/10	100 100 100 20	CA714/2 CA714/3 CA714/4 CA714/10	100 100 100 20	CA714/2 CA714/3 CA714/4 CA714/10	100 100 100 20
Marking Tag 	MT6	1 Pk. (100 tags)	MT6	1 Pk. (100 tags)	MT6	1 Pk. (100 tags)

# DISCONNECT & TEST

## SCREW TERMINAL BLOCKS

## SLIDER STYLE DISCONNECT TERMINAL BLOCKS

### HIGHLIGHTS

#### FEATURES

- Slider Style Disconnect Terminals
  - **CDTTU** - Standard Slider Disconnect
  - **CDTTU-SH** - Double Disconnect Terminal
  - **CDTTUFT** - Same profile Feed-Through
- Specially designed socket headed screws act as fast monitoring points
- Disconnect is achieved by operating sliding link with screw driver

#### APPLICATIONS

- Disconnect & Test Applications

#### CDTTU

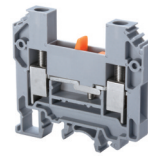

Slider Disconnect Terminal

#### CDTTU-SH

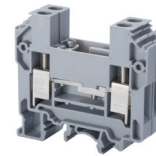

Slider Double Disconnect Terminal

#### CDTTUFT

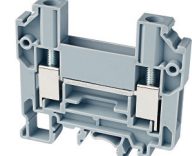

Feed Through Terminal Slider Disconnect Profile

#### Dimensions & Weight

	CDTTU	CDTTU-SH	CDTTUFT
Width	8 mm	16 mm	8 mm
Length	63 mm	63 mm	63 mm
Height w/ DIN Rail	35 x 7.5 mm 35 x 15 mm	58.7 mm 65.7 mm	58.7 mm 65.7 mm
Weight per piece	28.5 g	59.2 g	27.1 g

#### Technical Data/Ratings

Approvals							
Wire Size (solid / stranded)	16-8 AWG / 1.5-10 mm <sup>2</sup>		16-8 AWG	16-8 AWG	1.5-10 mm <sup>2</sup>	16-8 AWG / 1.5-10 mm <sup>2</sup>	
Voltage Rating	600 V / 800 V		300 V	300 V	160 V	600 V / 800 V	
Current Rating	41 A / 57 A		25 A	25 A	10 A	41 A / 57 A	
Torque	14 lb-in / 1.2 Nm		14 lb-in	14 lb-in	1.2 Nm	14 lb-in / 1.2 Nm	
Insulation Material	Polyamide 66		Polyamide 66			Polyamide 66	

#### Installation Instructions

Wire Stripping Length	CDTTU	CDTTU-SH	CDTTUFT
Wire Stripping Length	12 mm	12 mm	12 mm
Screwdriver	Flat Head 1.0 x 5.5 mm	Flat Head 1.0 x 5.5 mm	Flat Head 1.0 x 5.5 mm

#### Terminal Blocks

	Cat. No.	Std. Pk.	Cat. No.	Std. Pk.	Cat. No.	Std. Pk.
<b>Grey (standard)</b>	<b>CDTTU</b>	50	<b>CDTTU-SH</b>	20	<b>CDTTUFT</b>	50
Red R	CDTTU/R	50	CDTTU-SH/R	20	CDTTUFT/R	50
Blue BU	CDTTU/BU	50	CDTTU-SH/BU	20	CDTTUFT/BU	50
Black BL	CDTTU/BL	50	CDTTU-SH/BL	20	CDTTUFT/BL	50
Orange O	CDTTU/O	50	CDTTU-SH/O	20	CDTTUFT/O	50
Green G	CDTTU/G	50	CDTTU-SH/G	20	CDTTUFT/G	50
Yellow Y	CDTTU/Y	50	CDTTU-SH/Y	20	CDTTUFT/Y	50
White W	CDTTU/W	50	CDTTU-SH/W	20	CDTTUFT/W	50

#### Accessories

	Cat. No.	Std. Pk.	Cat. No.	Std. Pk.	Cat. No.	Std. Pk.
End Plate	EPCDTTU	50	EPCDTTU	50	EPCDTTU	50
DIN Rail	2511120	20	2511120	20	2511120	20
	CA701-15/S	20	CA701-15/S	20	CA701-15/S	20
	2511160	10	2511160	10	2511160	10
End Stop	CA702	50	CA702	50	CA702	50
	CA802	50	CA802	50	CA802	50
	CA202	25	CA202	25	CA202	25
Shorting Plug	QJ8/2	25	QJ8/2	25	QJ8/2	25
External Jumper	CA710/2	100	CA710/2	100	CA710/2	100
	CA710/3	50	CA710/3	50	CA710/3	50
	CA710/4	50	CA710/4	50	CA710/4	50
	CA710/10	20	CA710/10	20	CA710/10	20
Shorting Plug	QJ8/2	25	-	-	QJ8/2	25
Marking Tag	MT8	1 Pk. (100 tags)	MT8	1 Pk. (100 tags)	MT8	1 Pk. (100 tags)

### LEVER STYLE DISCONNECT TERMINAL BLOCKS

#### CSDL4U

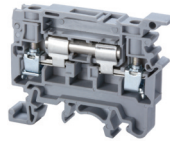

#### DDDL4U

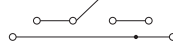
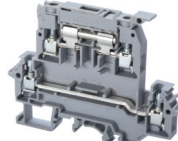

#### Dimensions & Weight

	Lever Style Disconnect	Lever Style Disconnect Bottom Level Feed Through
Width	8 mm	8 mm
Length	58 mm	88 mm
Height w DIN Rail	35 x 7.5 mm 35 x 15 mm	67.4 mm 74.3 mm
Weight per piece	15.0 g	27.0 g

#### Technical Data/Ratings

Approvals					
Wire Size (solid / stranded)	22-10 AWG	0.2-4 mm <sup>2</sup>	22-10 AWG	22-10 AWG	0.2-4 mm <sup>2</sup>
Voltage Rating	600 V	1000 V	600 V	600 V	800 V
Current Rating	Top Bottom	14 A -	6.3 A 35 A	14 A 32 A	10 A 32 A
Torque		7 lb-in 0.5 Nm	7 lb-in	7 lb-in	0.5 Nm
Insulation Material	Polyamide 66		Polyamide 66		

#### Installation Instructions

Wire Stripping Length	9.5 mm	9.5 mm
Screwdriver	Flat Head 0.6 x 3.5 mm	Flat Head 0.6 x 3.5 mm

#### Terminal Blocks

	Cat. No.	Std. Pk.	Cat. No.	Std. Pk.
<b>Grey (standard)</b>	<b>CSDL4U</b>	100	<b>DDDL4U</b>	20
Red R	CSDL4U/R	100	DDDL4U/R	20
Blue BU	CSDL4U/BU	100	DDDL4U/BU	20
Black BL	CSDL4U/BL	100	DDDL4U/BL	20
Orange O	CSDL4U/O	100	DDDL4U/O	20
Green G	CSDL4U/G	100	DDDL4U/G	20
Yellow Y	CSDL4U/Y	100	DDDL4U/Y	20
White W	CSDL4U/W	100	DDDL4U/W	20

#### Accessories

	Cat. No.	Std. Pk.	Cat. No.	Std. Pk.
End Plate	EPCSFL4U	50	EPDDL4U	50
Isolation Partition	PPCSFL4U	50	-	-
DIN Rail	2511120	20	2511120	20
	CA701-15/S	20	CA701-15/S	20
	2511160	10	2511160	10
End Stop	CA702	50	CA702	50
	CA802	50	CA802	50
	CA202	50	CA202	50
Internal Jumper	-	-	CA729/2	100
	-	-	CA729/3	50
	-	-	CA729/4	50
	-	-	CA729/10	10
Insulated Jumper	-	-	CA749/2	100
	-	-	CA749/3	50
	-	-	CA749/4	50
	-	-	CA749/10	10
External Jumper	CA711/2	100	CA711/2	100
	CA711/3	50	CA711/3	50
	CA711/4	50	CA711/4	50
	CA711/10	20	CA711/10	2
Marking Tag  on terminal on lever	MT8	1 Pk. (100 tags)	MT8	1 Pk. (100 tags)
	MT2	1 Pk. (100 tags)	MT2	1 Pk. (100 tags)

### HIGHLIGHTS

#### FEATURES

- Lever Style Disconnect Terminals
- **CSDL4U** - Standard Lever Disconnect
- **DDDL4U** - Lever Disconnect with Lower Level Feed-Through
- Same profile as **CAFL4U**

#### APPLICATIONS

- Disconnect Applications

### CDB4/X(1)

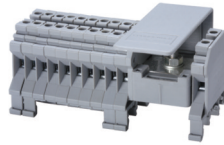

## HIGHLIGHTS

### FEATURES

- Distribution blocks with various output configurations
- Stud/Bolt to secure incoming wire
- Internally connected terminals
- Side/center feed versions
- up to 150A
- Protective shield for incoming wire

### APPLICATIONS

- Simplified distribution systems
- Phase distribution application

### INSTALLATION NOTES

- Sum of outgoing wires not to exceed incoming current
- Higher output currents should be connected close to the input

### Dimensions & Weight

Width	6 Outputs	52.0 mm
	8 Outputs	58.0 mm
	10 Outputs	64.0 mm
	12 Outputs	70.0 mm
	14 Outputs	76.0 mm
	22 Outputs	100.0 mm
24 Outputs	106.0 mm	

Length	43 mm
--------	-------

Height w DIN Rail	35 x 7.5 mm	46.2 mm
	35 x 15 mm	53.7 mm

50A Distribution Terminal Block Side Feed	
---	--

Width	52.0 mm
	58.0 mm
	64.0 mm
	70.0 mm
	76.0 mm
	100.0 mm
24 Outputs	106.0 mm

### General Specifications

Approvals	
-----------	--

--	--	--

Voltage Rating	600 V	800 V AC/DC
----------------	-------	-------------

Insulation Material	Polyamide 66	
---------------------	--------------	--

### INPUT

#### Technical Data/Ratings

Wire Size (solid / stranded)	10-8 AWG	6-16 mm <sup>2</sup>
------------------------------	----------	----------------------

Current Rating	50 A	64 A
----------------	------	------

Torque	26 lb-in	2.0 Nm
--------	----------	--------

### Installation Instructions

Wire Stripping Length	8 mm
-----------------------	------

Screwdriver	Hex Nut Driver M8
-------------	-------------------

### OUTPUT

#### Technical Data/Ratings

Wire Size (solid / stranded)	22-10 AWG	0.2-4 mm <sup>2</sup>
------------------------------	-----------	-----------------------

Current Rating	35 A	64 A*
----------------	------	-------

Torque	7 lb-in	0.5 Nm
--------	---------	--------

### Installation Instructions

Wire Stripping Length	8 mm
-----------------------	------

Screwdriver	Flat Head 0.6 x 3.5 mm
-------------	------------------------

### Terminal Blocks

Grey (standard)		
6 Outputs	CDB4/2(1)	10
8 Outputs	CDB4/3(1)	10
10 Outputs	CDB4/4(1)	10
12 Outputs	CDB4/5(1)	5
14 Outputs	CDB4/6(1)	5
22 Outputs	CDB4/10(1)	5
24 Outputs	CDB4/11(1)	5

Cat. No.	Std. Pk.
----------	----------

### Accessories

DIN Rail		2511120	20
		CA701-15/S	20
		2511160	10

End Stop		CA702	50
		CA802	50

Marking Tag		MT6	1 Pk. (100 tags)
-------------	--	-----	------------------

Cat. No.	Std. Pk.
----------	----------

\* Total output current of system

### Phase Distribution Application with CDB Terminals

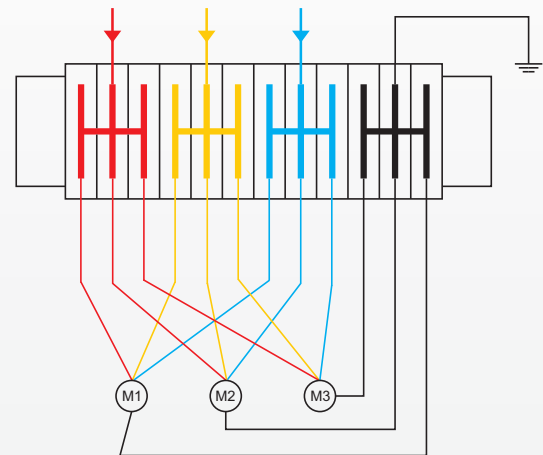

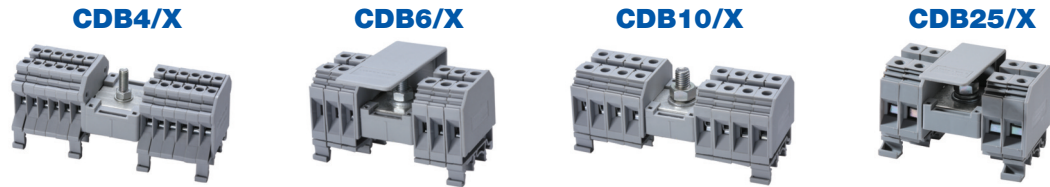

**Dimensions & Weight**

	50A Distribution Terminal Block Center Feed	100A Distribution Terminal Block Center Feed	130A Distribution Terminal Block Center Feed	150A Distribution Terminal Block Center Feed
<b>Width</b>	4 Outputs 8 Outputs 12 Outputs 16 Outputs 20 Outputs 24 Outputs	44.0 mm 56.0 mm 68.0 mm 80.0 mm 96.0 mm 108.0 mm	48.0 mm 64.0 mm 80.0 mm 96.0 mm -	- 88.0 mm 112.0 mm 136.0 mm -
<b>Length</b>	43 mm	48 mm	48 mm	49 mm
<b>Height w DIN Rail</b>	35 x 7.5 mm 35 x 15 mm	46.2 mm 53.7 mm	47.8 mm 55.5 mm	57.2 mm 64.7 mm

**General Specifications**

Approvals	CE	UL US E220514	CS US 60947-7-1	IEC 60947-7-1	UL US E220514	CS US 60947-7-1	IEC 60947-7-1	UL US E220514	CS US 60947-7-1	IEC 60947-7-1		
<b>Voltage Rating</b>	600 V		800 V AC/DC		600 V		800 V AC/DC		600 V		800 V AC/DC	
<b>Insulation Material</b>	Polyamide 66											

**INPUT**

**Technical Data/Ratings**

Wire Size (solid / stranded)	10-8 AWG	6-16 mm <sup>2</sup>	10-2 AWG	6-25 mm <sup>2</sup>	8-1/0 AWG	10-35 mm <sup>2</sup>	6-2/0 AWG	10-50 mm <sup>2</sup>
<b>Current Rating</b>	50 A	64 A	100 A	82 A	130 A	114 A	150 A	150 A
<b>Torque</b>	26 lb-in	2.0 Nm	35 lb-in	3.0 Nm	53 lb-in	6.0 Nm	53 lb-in	6.0 Nm

**Installation Instructions**

Wire Stripping Length	8 mm	9 mm	11 mm	14 mm
Screwdriver	Hex Nut Driver M8	Hex Nut Driver M10	Hex Nut Driver M13	Hex Nut Driver M15

**OUTPUT**

**Technical Data/Ratings**

Wire Size (solid / stranded)	22-10 AWG	0.2-4 mm <sup>2</sup>	22-8 AWG	1.5-6 mm <sup>2</sup>	22-6 AWG	1.5-10 mm <sup>2</sup>	12-2 AWG	6-25 mm <sup>2</sup>
<b>Current Rating (per output)</b>	35 A	32 A	50 A	41 A	65 A	57 A	75 A	75 A
<b>Torque</b>	7 lb-in	0.5 Nm	14 lb-in	0.8 Nm	14 lb-in	1.2 Nm	22 lb-in	2.0 Nm

**Installation Instructions**

Wire Stripping Length	8 mm	9 mm	11 mm	14 mm
Screwdriver	Flat Head 0.6 x 3.5 mm	Flat Head 0.8 x 4 mm	Flat Head 0.8 x 4 mm	Flat Head 1.0 x 5.5 mm

**Terminal Blocks**

	Cat. No.	Std. Pk.	Cat. No.	Std. Pk.	Cat. No.	Std. Pk.	Cat. No.	Std. Pk.
<b>Grey (standard)</b>								
4 Outputs	CDB4/1	10	CDB6/1	10	-	-	CDB25/1	10
8 Outputs	CDB4/2	10	CDB6/2	10	CDB10/2	10	CDB25/2	10
12 Outputs	CDB4/3	10	CDB6/3	10	CDB10/3	10	CDB25/3	10
16 Outputs	CDB4/4	10	CDB6/4	5	CDB10/4	5	CDB25/4	5
20 Outputs	CDB4/5	5	-	-	-	-	-	-
24 Outputs	CDB4/6	5	-	-	-	-	-	-

**Accessories**

	Cat. No.	Std. Pk.	Cat. No.	Std. Pk.	Cat. No.	Std. Pk.	Cat. No.	Std. Pk.
<b>DIN Rail</b>								
32mm	2511120	20	2511120	20	2511120	20	2511120	20
35mm	CA701-15/S	20	CA701-15/S	20	CA701-15/S	20	CA701-15/S	20
	2511160	10	2511160	10	2511160	10	2511160	10
<b>End Stop</b>	CA702	50	CA702	50	CA702	50	CA702	50
	CA802	50	CA802	50	CA802	50	CA802	50
<b>Marking Tag</b>	MT6	1 Pk. (100 tags)	MT8	1 Pk. (100 tags)	MT10	1 Pk. (100 tags)	MT12	1 Pk. (100 tags)



### CMDB4/X



### CMDB6/X



### CMDB10/X



### CMDB25/X



### Dimensions

	35 A Distribution Terminal Block	50 A Distribution Terminal Block	65 A Distribution Terminal Block	85 A Distribution Terminal Block	
<b>Width</b>	2 pole 3 pole 4 pole 10 pole	13.5 mm 19.5 mm 25.5 mm 61.5 mm	17.5 mm 25.5 mm 33.5 mm 81.5 mm	21.5 mm 31.5 mm 41.5 mm 101.5 mm	26.0 mm 38.0 mm 50.0 mm 62.0 mm
<b>Length</b>	43 mm	48 mm	48 mm	49 mm	
<b>Height w DIN Rail</b>	35 x 7.5 mm 35 x 15 mm	46.2 mm 53.7 mm	47.8 mm 55.5 mm	47.8 mm 55.5 mm	57.2 mm 64.7 mm

### Technical Data/Ratings

Approvals								
<b>Wire Size (solid / stranded)</b>	<b>22-10 AWG</b>	0.2-4 mm <sup>2</sup>	<b>22-8 AWG</b>	1.5-6 mm <sup>2</sup>	<b>22-6 AWG</b>	1.5-10 mm <sup>2</sup>	<b>12-4 AWG</b>	6.0-25 mm <sup>2</sup>
<b>Voltage Rating</b>	600 V	1000V AC/DC	600 V	1000V AC/DC	600 V	1000V AC/DC	600 V	800V AC/DC
<b>Current Rating</b>	35 A	32 A	50 A	41 A	65 A	57 A	85 A	101 A
<b>Torque</b>	7 lb-in	0.5 Nm	14 lb-in	0.8 Nm	14 lb-in	1.2 Nm	22 lb-in	2.0 Nm
<b>Insulation Material</b>	Polyamide 66		Polyamide 66		Polyamide 66		Polyamide 66	

### Installation Instructions

<b>Wire Stripping Length</b>	8 mm	9 mm	11 mm	14 mm
<b>Screwdriver</b>	Flat Head 0.6 x 3.5 mm	Flat Head 0.8 x 4 mm	Flat Head 0.8 x 4 mm	Flat Head 1.0 x 5.5 mm

### Terminal Blocks

#### 4 Outputs

	Cat. No.	Std. Pk.	Cat. No.	Std. Pk.	Cat. No.	Std. Pk.	Cat. No.	Std. Pk.
<b>Grey (standard)</b>	<b>CMDB4/2</b>	10	<b>CMDB6/2</b>	10	<b>CMDB10/2</b>	10	<b>CMDB25/2</b>	10
Red R	CMDB4/2/R	10	CMDB6/2/R	10	CMDB10/2/R	10	CMDB25/2/R	10
Blue BU	CMDB4/2/BU	10	CMDB6/2/BU	10	CMDB10/2/BU	10	CMDB25/2/BU	10
Black BL	CMDB4/2/BL	10	CMDB6/2/BL	10	CMDB10/2/BL	10	CMDB25/2/BL	10

#### 6 Outputs

	Cat. No.	Std. Pk.	Cat. No.	Std. Pk.	Cat. No.	Std. Pk.	Cat. No.	Std. Pk.
<b>Grey (standard)</b>	<b>CMDB4/3</b>	10	<b>CMDB6/3</b>	10	<b>CMDB10/3</b>	10	<b>CMDB25/3</b>	10
Red R	CMDB4/3/R	10	CMDB6/3/R	10	CMDB10/3/R	10	CMDB25/3/R	10
Blue BU	CMDB4/3/BU	10	CMDB6/3/BU	10	CMDB10/3/BU	10	CMDB25/3/BU	10
Black BL	CMDB4/3/BL	10	CMDB6/3/BL	10	CMDB10/3/BL	10	CMDB25/3/BL	10

#### 8 Outputs

	Cat. No.	Std. Pk.	Cat. No.	Std. Pk.	Cat. No.	Std. Pk.	Cat. No.	Std. Pk.
<b>Grey (standard)</b>	<b>CMDB4/4</b>	10	<b>CMDB6/4</b>	10	<b>CMDB10/4</b>	10	<b>CMDB25/4</b>	10
Red R	CMDB4/4/R	10	CMDB6/4/R	10	CMDB10/4/R	10	CMDB25/4/R	10
Blue BU	CMDB4/4/BU	10	CMDB6/4/BU	10	CMDB10/4/BU	10	CMDB25/4/BU	10
Black BL	CMDB4/4/BL	10	CMDB6/4/BL	10	CMDB10/4/BL	10	CMDB25/4/BL	10

#### 20 Outputs

	Cat. No.	Std. Pk.	Cat. No.	Std. Pk.	Cat. No.	Std. Pk.	Cat. No.	Std. Pk.
<b>Grey (standard)</b>	<b>CMDB4/10</b>	10	<b>CMDB6/10</b>	10	<b>CMDB10/10</b>	5	<b>CMDB25/10</b>	10
Red R	CMDB4/10/R	10	CMDB6/10/R	10	CMDB10/10/R	5	CMDB25/10/R	10
Blue BU	CMDB4/10/BU	10	CMDB6/10/BU	10	CMDB10/10/BU	5	CMDB25/10/BU	10
Black BL	CMDB4/10/BL	10	CMDB6/10/BL	10	CMDB10/10/BL	5	CMDB25/10/BL	10

### Accessories

	Cat. No.	Std. Pk.	Cat. No.	Std. Pk.	Cat. No.	Std. Pk.	Cat. No.	Std. Pk.
<b>DIN Rail</b>	2511120	20	2511120	20	2511120	20	2511120	20
	CA701-15/S	20	CA701-15/S	20	CA701-15/S	20	CA701-15/S	20
	2511160	10	2511160	10	2511160	10	2511160	10
<b>End Stop</b>	CA702	50	CA702	50	CA702	50	CA702	50
	CA802	50	CA802	50	CA802	50	CA802	50
<b>Marking Tag</b>	MT6	1 Pk. (100 tags)	MT8	1 Pk. (100 tags)	MT10	1 Pk. (100 tags)	MT12	1 Pk. (100 tags)

**CXDB35/10**

**CXDB35/10A**

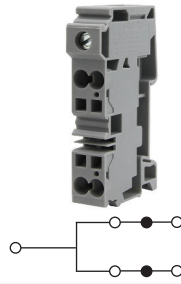

1 Flat Head Screw Input  
4 Spring Clamp Outputs

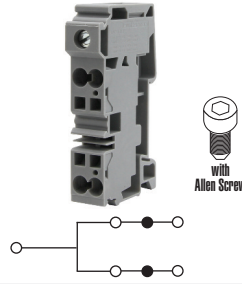

1 Hex Screw Input  
4 Spring Clamp Outputs

**Dimensions & Weight**

Width	16 mm	16 mm
Length	81.6 mm	81.6 mm
Height w DIN Rail	35 x 7.5 mm 35 x 15 mm	46.8 mm 54.3 mm
Weight per piece	53.2 g	53.2 g

**General Specifications**

Approvals		
Voltage Rating	600 V 1000V AC/DC	600 V 1000V AC/DC
Insulation Material	Polyamide 66	Polyamide 66

**INPUT**

**Technical Data/Ratings**

Wire Size (solid / stranded)	14-2 AWG 1.5-35 mm <sup>2</sup>	14-2 AWG 1.5-35 mm <sup>2</sup>
Current Rating	115 A 125 A	115 A 125 A
Torque	25 lb-in 2.5 Nm	25 lb-in 2.5 Nm

**Installation Instructions**

Wire Stripping Length	17 mm	17 mm
Screwdriver	Flat Head 1.0 x 5.5 mm	Hex Screw M5

**OUTPUT**

**Technical Data/Ratings**

Wire Size (solid / stranded)	24-8 AWG 0.2-10 mm <sup>2</sup>	24-8 AWG 0.2-10 mm <sup>2</sup>
Current Rating	41 A 41 A	41 A 41 A

**Installation Instructions**

Wire Stripping Length	15 mm	15 mm
Screwdriver	Flat Head 0.8 x 4 mm	Flat Head 0.8 x 4 mm

**Terminal Blocks**

	Cat. No.	Std. Pk.	Cat. No.	Std. Pk.
<b>Grey</b>	<b>CXDB35/10</b>	20	<b>CXDB35/10A</b>	20

**Accessories**

	Cat. No.	Std. Pk.	Cat. No.	Std. Pk.
DIN Rail	2511120 CA701-15/S	20 20	2511120 CA701-15/S	20 20
End Clamp	CA702 CA802 CA103	50 50 50	CA702 CA802 CA103	50 50 50
Jumpers	JX6/2 JX6/3 JX6/4 JX6/10	100 50 50 10	JX6/2 JX6/3 JX6/4 JX6/10	100 50 50 10
Marking Tag	MT16	1 Pk. (100 tags)	MT16	1 Pk. (100 tags)

**HIGHLIGHTS**

**FEATURES**

- Hybrid Distribution Terminal Block
- Screw input (115A)
- 4 spring clamp outputs (4 x41A)
- Modular system
- Standard slot & hex screw versions
- Expandable with standard CX Series jumpers and terminal blocks
- Easy Installation

**APPLICATIONS**

- Miniature Circuit Breaker (MCB) distribution
- Limited space distribution

**Output Expansion**

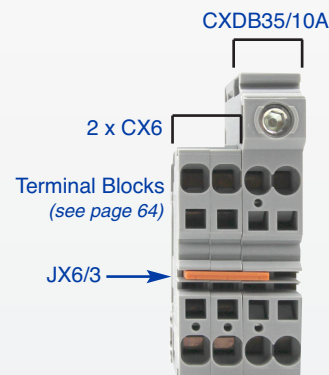

**MCB Distribution Example**



### HIGHLIGHTS

#### FEATURES

- 3 Clamp Sizes
- Panel Mount
  - NES
  - NEB6
- DIN Rail Mount
  - CA202
  - NEB10
- Tin Plated Copper Busbars
- Busbar Current rating 140A
- Standard Color: Green
- Various colors

#### APPLICATIONS

- Grounding Solution
- Terminating Neutral an Grounding Wires to a single busbar
- Distribution Applications



#### Dimensions & Weight

	CENC4	CENC16	CENC35
Width	7.5 mm	9.8 mm	14.5 mm
Length	23.3 mm	23.3 mm	27.3 mm
Weight per piece	8 g	10.5 g	20 g

#### Technical Data/Ratings

Approvals	CE	UL E220514	CS US 60947-7-2	IEC 60947-7-2	UL E220514	CS US 60947-7-2	IEC 60947-7-2	UL E220514	CS US 60947-7-2	IEC 60947-7-2
Wire Size (solid / stranded)	22-12 AWG	22-12 AWG	0.2-6 mm <sup>2</sup>	10-6 AWG	10-6 AWG	10-16 mm <sup>2</sup>	8-2 AWG	8-2 AWG	10-35 mm <sup>2</sup>	
Voltage Rating	600 V	600 V	800 V	600 V	600 V	800 V	600 V	600 V	800 V	
Current Rating	-	-	37 A	-	-	76 A	-	-	125 A	
Torque	14 lb-in	14 lb-in	0.8 Nm	17.5 lb-in	17.5 lb-in	2.0 Nm	25 lb-in	25 lb-in	2.5 Nm	
Insulation Material	Polyamide 66			Polyamide 66			Polyamide 66			

#### Installation Instructions

Wire Stripping Length	CENC4	CENC16	CENC35
Wire Stripping Length	12 mm	16 mm	16 mm
Screwdriver	Flat Head 0.8 x 4 mm	Flat Head 1.0 x 5.5 mm	Flat Head 1.0 x 5.5 mm

#### Terminal Blocks

	Cat. No.	Std. Pk.	Cat. No.	Std. Pk.	Cat. No.	Std. Pk.
<b>Green (standard)</b>						
Black	BL	50	CENC16	50	CENC35	50
Blue	BU	50	CENC16/BL	50	CENC35/BL	50
Grey	GR	50	CENC16/BU	50	CENC35/BU	50
Yellow	Y	50	CENC16/GR	50	CENC35/GR	50
			CENC16/Y	50	CENC35/Y	50

#### Mounting Accessories

##### Panel Mount

	Cat. No.	Std. Pk.	Cat. No.	Std. Pk.	Cat. No.	Std. Pk.
Busbar (6 x 6 mm)	NEB6	1 m	NEB6	1 m	NEB6	1 m
Plastic Support with Fixing Screw	NES	50	NES	50	NES	50
Marking Tag	MT5	1 Pk. (100 tags)	MT6	1 Pk. (100 tags)	MT6	1 Pk. (100 tags)

##### Mounting Accessories

##### DIN Rail Mount

	Cat. No.	Std. Pk.	Cat. No.	Std. Pk.	Cat. No.	Std. Pk.
Busbar (10 x 3 mm)	NEB10	1 m	NEB10	1 m	NEB10	1 m
End Clamp/Busbar support for rail mounting	CA202	50	CA202	50	CA202	50
Marking Tag	MT5	1 Pk. (100 tags)	MT6	1 Pk. (100 tags)	MT6	1 Pk. (100 tags)

#### Panel Mount Assembly Example

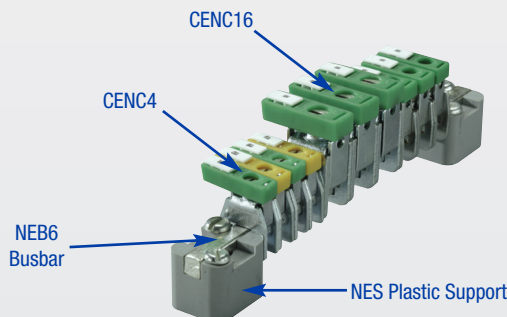

#### DIN Rail Mount Assembly Example

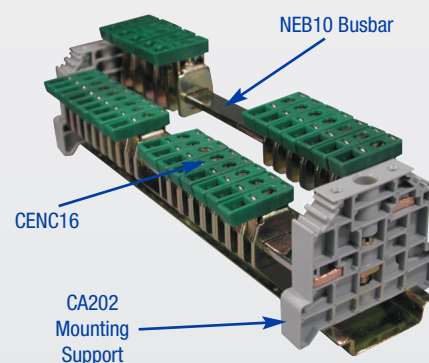

**CHV4U**



**CHV6U**

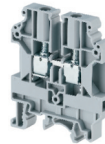

**CHV10U**



**Dimensions & Weight**

Width	<b>6 mm</b>	<b>8 mm</b>	<b>10 mm</b>
Length	52 mm	52 mm	52 mm
Height w/ DIN Rail	35 x 7.5 mm 35 x 15 mm	63.4 mm 70.8 mm	63.4 mm 70.8 mm
Weight per piece	11.0 g	16.0 g	21.6 g

**Technical Data/Ratings**

Approvals						
Wire Size (solid / stranded)	<b>22-10 AWG</b>	0.2-4 mm <sup>2</sup>	<b>22-8 AWG</b>	0.2-6 mm <sup>2</sup>	<b>20-6 AWG</b>	0.2-10 mm <sup>2</sup>
Voltage Rating	1000 V	1500 V AC/DC	1000 V	1500 V AC/DC	1000 V	1500 V AC/DC
Current Rating	35 A	32 A	50 A	41 A	65 A	57 A
Torque	7 lb-in	0.5 Nm	14 lb-in	0.8 Nm	14 lb-in	1.2 Nm
Insulation Material	Polyamide 66		Polyamide 66		Polyamide 66	

**Installation Instructions**

Wire Stripping Length	12 mm	14 mm	14 mm
Screwdriver	Flat Head 0.6 x 3.5 mm	Flat Head 0.8 x 4 mm	Flat Head 0.8 x 4 mm

**Terminal Blocks**

	Cat. No.	Std. Pk.	Cat. No.	Std. Pk.	Cat. No.	Std. Pk.
<b>Grey (standard)</b>	<b>CHV4U</b>	50	<b>CHV6U</b>	50	<b>CHV10U</b>	50
Red R	CHV4U/R	50	CHV6U/R	50	CHV10U/R	50
Blue BU	CHV4U/BU	50	CHV6U/BU	50	CHV10U/BU	50
Black BL	CHV4U/BL	50	CHV6U/BL	50	CHV10U/BL	50
Orange O	CHV4U/O	50	CHV6U/O	50	CHV10U/O	50
Green G	CHV4U/G	50	CHV6U/G	50	CHV10U/G	50
Yellow Y	CHV4U/Y	50	CHV6U/Y	50	CHV10U/Y	50
White W	CHV4U/W	50	CHV6U/W	50	CHV10U/W	50

**Accessories**

	Cat. No.	Std. Pk.	Cat. No.	Std. Pk.	Cat. No.	Std. Pk.	
End Plate	EPUSC	50	EPUSC	50	EPUSC	50	
Separator Plate	SP2.5/4UN	50	SP2.5/4UN	50	SP2.5/4UN	50	
DIN Rail	2511120 CA701-15/S 2511160	20 20 10	2511120 CA701-15/S 2511160	20 20 10	2511120 CA701-15/S 2511160	20 20 10	
End Stop	CA702 CA802 CA202	50 50 25	CA702 CA802 CA202	50 50 25	CA702 CA802 CA202	50 50 25	
Internal Jumper	2 pole 3 pole 4 pole 10 pole 100 pole	CA623/2 CA623/3 CA623/4 CA623/10	100 100 100 10	CA624/2 CA624/3 CA624/4 CA624/10	100 100 100 10	CA625/2 CA625/3 CA625/4 CA625/10	100 100 100 10
Marking Tag	MT6	1 Pk. (100 tags)	MT8	1 Pk. (100 tags)	MT10	1 Pk. (100 tags)	

**HIGHLIGHTS**

**FEATURES**

- High Voltage Terminal Blocks
- 1000V UL Rating
- 1500V IEC DC Rating
- Same Profile on all Current Ratings

**APPLICATIONS**

- Solar Applications
- High Voltage Applications

# THERMOCOUPLE

SCREW TERMINAL BLOCKS

THERMOCOUPLE BLOCKS

## HIGHLIGHTS

### FEATURES

- Thermocouple terminal blocks are used to extend thermocouple compensating lines in measuring circuits
- The current bar of the terminal block is made of the same material as the thermocouple wire (As per EN 60584/DINEN 60584)
- No loss of potential at the connection points
- Available types:
  - K Type** - Chromel (NiCr), Alumel (Ni)
  - J Type** - Iron (Fe), Constantan (CuNi)
  - T Type** - Copper (Cu), Constantan (CuNi)
  - E Type** - Chromel (NiCr), Constantan (CuNi)

### APPLICATIONS

- Measurement applications

## CTT2.5UK/J/T/E

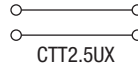

### Dimensions & Weight

Width	10 mm	
Length	43 mm	
Height w DIN Rail	35 x 7.5 mm	46.2 mm
	35 x 15 mm	53.7 mm
Weight per piece	12.4 g	

### Technical Data/Ratings

Approvals		
Wire Size (solid / stranded)	22-14 AWG	0.2-2.5 mm <sup>2</sup>
Voltage Rating	1000 V AC/DC	
Current Rating	10 A	
Torque	7 lb-in / 0.4 Nm	
Insulation Material	Polyamide 66	

### Installation Instructions

Wire Stripping Length	8 mm
Screwdriver	Flat Head 0.5 x 3 mm

### Terminal Blocks

	Cat. No.	Std. Pk.
Grey		
U Type	CTT2.5UK	50
J Type	CTT2.5UJ	50
T Type	CTT2.5UT	50
G Type	CTT2.5UG	50

### Accessories

	Cat. No.	Std. Pk.
End Plate	EP2.5/4UN	50
Partition Plate	PP2.5/4UN	50
DIN Rail	2511120	20
	CA701-15/S	20
	2511160	10
End Stop	CA702	100
	CA802	100
Marking Tag	INCLUDED	

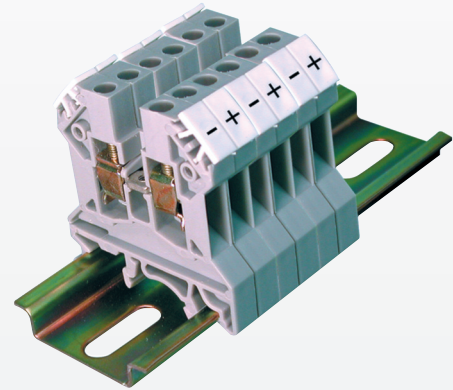

### Typical Temperature Measuring Circuit

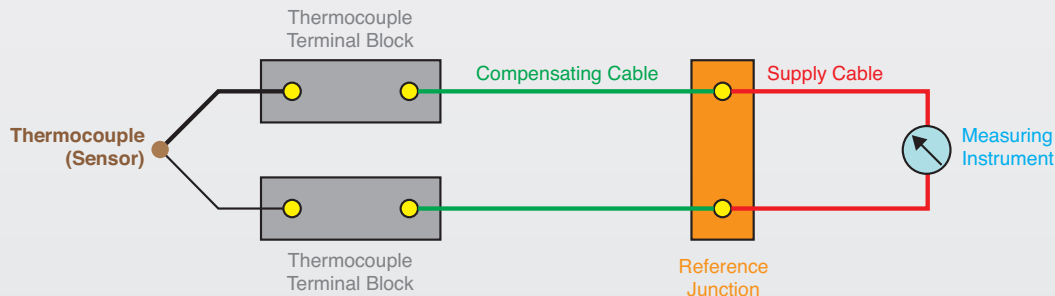



**CTC4U**

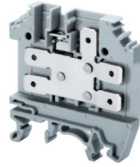

**Dimensions & Weight**

<b>Width</b>	<b>6 mm</b>
Length	47 mm
Height w DIN Rail	51.2 mm 58.8 mm
Weight per piece	8.0 g

**Technical Data/Ratings**

Approvals	
Wire Size (solid   stranded)	0.2-4.0 mm <sup>2</sup>   24-12 AWG
Voltage Rating	300 V
Current Rating	32 A
Tab (Blade) Size	6.3x0.8 mm
Insulation Material	Polyamide 66

**Installation Instructions**

Wire Stripping Length	9 mm
-----------------------	------

**Terminal Blocks**

	Cat. No.	Std. Pk.
<b>Grey (standard)</b>	<b>CTC4U</b>	100
Red R	CTC4U/R	100
Blue BU	CTC4U/BU	100
Black BL	CTC4U/BL	100
Orange O	CTC4U/O	100
Green G	CTC4U/G	100
Yellow Y	CTC4U/Y	100
White W	CTC4U/W	100

**Accessories**

	Cat. No.	Std. Pk.
End Plate	EPCTC4U	50
DIN Rail	2511120	20
	CA701-15/S	20
	2511160	10
End Stop	CA702	100
	CA802	100
Test Socket	CA707/TS/01	
Marking Tag	MT6	1 Pk. (100 tags)

**HIGHLIGHTS**

**FEATURES**

- Standard tab connection terminals
- Quick-Connect Tabs

**APPLICATIONS**

- Transportation
- Railroad Applications

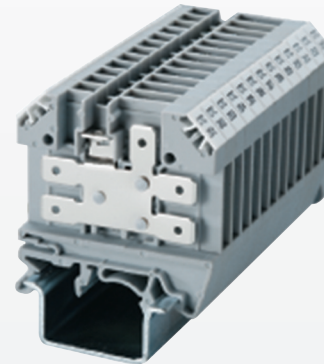

### HIGHLIGHTS

#### FEATURES

- Feed Through Terminals with Springs below clamps
- High torque screws
- Built-in springs guarantee secure connection even when screw is not tight
- 4 mm, 6 mm, 10mm terminal blocks with same size profile
- It is recommended to use hook type lugs/ ferrules for wire termination
- Both, high-torque screws and built-in spring
- Various disconnect terminals

#### APPLICATIONS

- Vibration Applications
- Projects which follow the following safety regulations:
  - Electric Supply Standard (ESI)
  - British CEGB Standard
  - NTPC standard

### CTS4USC



### CTS6USC

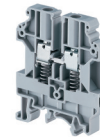

### CTS10USC

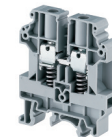

#### Dimensions & Weight

	Feed Through Terminal Spring Loaded	Feed Through Terminal Spring Loaded	Feed Through Terminal Spring Loaded
<b>Width</b>	<b>6 mm</b>	<b>8 mm</b>	<b>10 mm</b>
Length	52 mm	52 mm	52 mm
Height w DIN Rail	35 x 7.5 mm 35 x 15 mm	63.4 mm 70.8 mm	63.4 mm 70.8 mm
Weight per piece	13.0 g	10.0 g	12.6 g

#### Technical Data/Ratings

Approvals						
Wire Size (solid / stranded)	<b>22-10 AWG</b>		0.2-4 mm <sup>2</sup>		<b>22-8 AWG</b>	
Voltage Rating	600 V		1500V AC/DC		1000 V	
Current Rating	35 A		32 A		41 A	
Torque	7 lb-in		0.5 Nm		14 lb-in	
Insulation Material	Polyamide 66		Polyamide 66		Polyamide 66	
	60947-7-1		60947-7-1		60947-7-1	
	0.2-10 mm <sup>2</sup>		1500V AC/DC		57 A	
	1500V AC/DC		1.2 Nm		1.2 Nm	

#### Installation Instructions

Wire Stripping Length	12 mm	14 mm	14 mm
Screwdriver	Flat Head 0.6 x 3.5 mm	Flat Head 0.8 x 4 mm	Flat Head 0.8 x 4 mm

#### Terminal Blocks

	Cat. No.	Std. Pk.	Cat. No.	Std. Pk.	Cat. No.	Std. Pk.
<b>Grey (standard)</b>	<b>CTS4USC</b>	50	<b>CTS6USC</b>	50	<b>CTS10USC</b>	50
Red R	CTS4USC/R	50	CTS6USC/R	50	CTS10USC/R	50
Blue BU	CTS4USC/BU	50	CTS6USC/BU	50	CTS10USC/BU	50
Black BL	CTS4USC/BL	50	CTS6USC/BL	50	CTS10USC/BL	50
Orange O	CTS4USC/O	50	CTS6USC/O	50	CTS10USC/O	50
Green G	CTS4USC/G	50	CTS6USC/G	50	CTS10USC/G	50
Yellow Y	CTS4USC/Y	50	CTS6USC/Y	50	CTS10USC/Y	50
White W	CTS4USC/W	50	CTS6USC/W	50	CTS10USC/W	50

#### Accessories

	Cat. No.	Std. Pk.	Cat. No.	Std. Pk.	Cat. No.	Std. Pk.
End Plate	EPUSC	50	EPUSC	50	EPUSC	50
Separator Plate	SP2.5/4UN	50	SP2.5/4UN	50	SP2.5/4UN	50
DIN Rail	2511120	20	2511120	20	2511120	20
	CA701-15/S	20	CA701-15/S	20	CA701-15/S	20
	2511160	10	2511160	10	2511160	10
End Stop	CA702	100	CA702	100	CA702	100
	CA802	50	CA802	50	CA802	50
	CA202	50	CA202	50	CA202	50
Hook Type	CA604/1	100	CA604/1	100	CA604/1	100
Lug / Ferrule	CA604/2	100	CA604/2	100	CA604/2	100
	CA604/5	100	CA604/5	100	CA604/5	100
	CA604/4	100	CA604/4	100	CA604/4	100
	CA604/3	100	CA604/3	100	CA604/3	100
Pre Assembled Jumpers	CA623/2	100	CA624/2	100	CA625/2	100
	CA623/3	100	CA624/3	100	CA625/3	100
	CA623/4	100	CA624/4	100	CA625/4	100
	CA623/10	10	CA624/10	10	CA625/10	10
Marking Tag	MT6	1 Pk. (100 tags)	MT8	1 Pk. (100 tags)	MT10	1 Pk. (100 tags)

**CKT4SPSC**

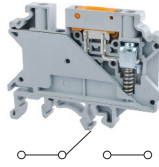

**CDS6U/SC**

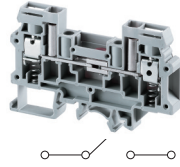

**CDTTUSC**

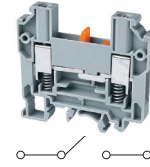

**CDTTUFTSC**

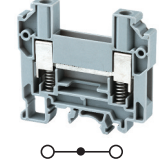

**Dimensions & Weight**

	CKT4SPSC	CDS6U/SC	CDTTUSC	CDTTUFTSC
Width	6 mm	8 mm	8 mm	8 mm
Length	58.5 mm	82 mm	63 mm	63 mm
Height w DIN Rail	35 x 7.5 mm 35 x 15 mm	46.0 mm 53.5 mm	58.7 mm 65.7 mm	58.7 mm 65.7 mm
Weight per piece	14.1 g	30.9 g	31.0 g	25.4 g

**Technical Data/Ratings**

Approvals								
Wire Size (solid / stranded)	24-10 AWG	0.2-4 mm <sup>2</sup>	22-8 AWG	0.2-6 mm <sup>2</sup>	16-8 AWG	1.5-10 mm <sup>2</sup>	16-8 AWG	1.5-10 mm <sup>2</sup>
Voltage Rating	600 V	1000V AC/DC	600 V	800V AC/DC	600 V	800V AC/DC	600 V	800V AC/DC
Current Rating	30 A	28 A	45 A	41 A	41 A	57 A	41 A	57 A
Torque	4.5 lb-in	0.5Nm	14 lb-in	0.8 Nm	14 lb-in	1.2Nm	14 lb-in	1.2Nm
Insulation Material	Polyamide 66		Polyamide 66		Polyamide 66		Polyamide 66	

**Installation Instructions**

Wire Stripping Length	CKT4SPSC	CDS6U/SC	CDTTUSC	CDTTUFTSC
Screwdriver	Flat Head 0.6 x 3.5 mm	Flat Head 0.8 x 4 mm	Flat Head 1.0 x 5.5 mm	Flat Head 1.0 x 5.5 mm

**Terminal Blocks**

	Cat. No.	Std. Pk.	Cat. No.	Std. Pk.	Cat. No.	Std. Pk.	Cat. No.	Std. Pk.
<b>Grey (standard)</b>	<b>CKT4SPSC</b>	50	<b>CDS6U/SC</b>	50	<b>CDTTUSC</b>	50	<b>CDTTUFTSC</b>	50
Red R	CKT4SPSC/R	50	CDS6U/SC/R	50	CDTTUSC/R	50	CDTTUFTSC/R	50
Blue BU	CKT4SPSC/BU	50	CDS6U/SC/BU	50	CDTTUSC/BU	50	CDTTUFTSC/BU	50
Black BL	CKT4SPSC/BL	50	CDS6U/SC/BL	50	CDTTUSC/BL	50	CDTTUFTSC/BL	50
Orange O	CKT4SPSC/O	50	CDS6U/SC/O	50	CDTTUSC/O	50	CDTTUFTSC/O	50
Green G	CKT4SPSC/G	50	CDS6U/SC/G	50	CDTTUSC/G	50	CDTTUFTSC/G	50
Yellow Y	CKT4SPSC/Y	50	CDS6U/SC/Y	50	CDTTUSC/Y	50	CDTTUFTSC/Y	50
White W	CKT4SPSC/W	50	CDS6U/SC/W	50	CDTTUSC/W	50	CDTTUFTSC/W	50

**Accessories**

	Cat. No.	Std. Pk.	Cat. No.	Std. Pk.	Cat. No.	Std. Pk.	Cat. No.	Std. Pk.
End Plate	-	-	EPDCS6U	50	EPCDTTU	50	EPCDTTU	50
DIN Rail	2511120 CA701-15/S 2511160	20 20 10	2511120 CA701-15/S 2511160	20 20 10	2511120 CA701-15/S 2511160	20 20 10	2511120 CA701-15/S 2511160	20 20 10
End Stop	CA702 CA802 CA202	100 50 50	CA702 CA802 CA202	100 50 50	CA702 CA802 CA202	100 50 50	CA702 CA802 CA202	100 50 50
Pre Assembled Jumpers	CA722/2 CA722/3 CA722/4 CA722/10 CA722/100	100 100 100 10 10	CA723/2 CA723/3 CA723/4 CA723/10	100 50 50 10	- - - -	- - - -	- - - -	- - - -
Insulated Jumpers	CA742/2 CA742/3 CA742/4 CA742/10 CA742/100	100 100 100 10 10	- - - - -	- - - - -	- - - - -	- - - - -	- - - - -	- - - - -
External Jumpers	CA714/2 CA714/3 CA714/4 CA714/10	100 100 100 20	- - - -	- - - -	CA710/2 CA710/3 CA710/4 CA710/10	100 50 50 20	CA710/2 CA710/3 CA710/4 CA710/10	100 50 50 20
Shorting Plug	-	-	-	-	QJ8/2	25	-	-
Marking Tag	MT6	1 Pk. (100 tags)	MT8	1 Pk. (100 tags)	MT8	1 Pk. (100 tags)	MT8	1 Pk. (100 tags)

### HIGHLIGHTS

#### FEATURES

- Various configurations of Electronic components soldered into **CDL4U** double level terminal block
- Various Diode / Resistor combinations
- 4 connection points for convenient wiring
- Terminal Block with open current bar **CDL4U(O)** can be individually soldered with electronic components
- Spacer **CDL4USP** can be used to cover overlapping components when soldered individually

#### APPLICATIONS

- Reverse polarity protection
- Lamp testing

### CDL4U(E)D1/D2

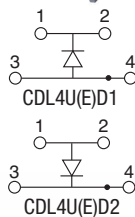
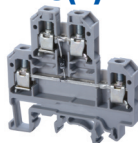

### CDL4U(E)D3



### CDL4U(E)DD1/DD2

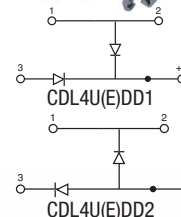

#### Dimensions & Weight

	CDL4U(E)D1/D2	CDL4U(E)D3	CDL4U(E)DD1/DD2
Width	6 mm	6 mm	6 mm
Length	55.5 mm	55.5 mm	55.5 mm
Height w DIN Rail	35 x 7.5 mm 35 x 15 mm	55.7 mm 63.1 mm	55.7 mm 63.1 mm
Weight per piece	13.6 g	13.4 g	13.4 g

#### Technical Data/Ratings

Approvals	CDL4U(E)D1/D2			CDL4U(E)D3			CDL4U(E)DD1/DD2		
	CE	UL US E220514	UL US C 60947-7-1	UL US E220514	UL US C 60947-7-1	UL US E220514	UL US C 60947-7-1	UL US E220514	UL US C 60947-7-1
Wire Size (solid / stranded)	22-10 AWG 0.2-4 mm <sup>2</sup>			22-10 AWG 0.2-4 mm <sup>2</sup>			22-10 AWG 0.2-4 mm <sup>2</sup>		
Voltage Rating	600 V	300 V	500 V AC	600 V	300 V	500 V AC	600 V	300 V	500 V AC
Current Rating	35 A	25 A	32 A	35 A	25 A	32 A	35 A	25 A	32 A
Torque	7 lb-in 0.5 Nm			7 lb-in 0.5 Nm			7 lb-in 0.5 Nm		
Insulation Material	Polyamide 66			Polyamide 66			Polyamide 66		

#### Electronic Component Specifications

	CDL4U(E)D1/D2	CDL4U(E)D3	CDL4U(E)DD1/DD2
Diode Type	1N 4007	1N 4007	1N 4007
Diode Reverse Voltage / Current	1000 V / 1 A	1000 V / 1 A	1000 V / 1 A
Indicator Voltage	-	-	-

#### Installation Instructions

	CDL4U(E)D1/D2	CDL4U(E)D3	CDL4U(E)DD1/DD2
Wire Stripping Length	9 mm	9 mm	9 mm
Screwdriver	Flat Head 0.6 x 3.5 mm	Flat Head 0.6 x 3.5 mm	Flat Head 0.6 x 3.5 mm

#### Terminal Blocks

	Cat. No.	Std. Pk.	Cat. No.	Std. Pk.	Cat. No.	Std. Pk.
Grey	CDL4U(E)D1	100	CDL4U(E)D3	100	CDL4U(E)DD1	100
	CDL4U(E)D2	100			CDL4U(E)DD2	100

#### Accessories

	Cat. No.	Std. Pk.	Cat. No.	Std. Pk.	Cat. No.	Std. Pk.
End Plate	EPCDL4U	50	EPCDL4U	50	EPCDL4U	50
Spacer	CDL4USP	50	CDL4USP	50	CDL4USP	50
DIN Rail	2511120	20	2511120	20	2511120	20
	CA701-15/S	20	CA701-15/S	20	CA701-15/S	20
	2511160	10	2511160	10	2511160	10
End Stop	CA702	50	CA702	50	CA702	50
	CA802	50	CA802	50	CA802	50
Internal Jumper	2 pole CA727/2	100	2 pole CA727/2	100	2 pole CA727/2	100
	3 pole CA727/3	100	3 pole CA727/3	100	3 pole CA727/3	100
	4 pole CA727/4	100	4 pole CA727/4	100	4 pole CA727/4	100
	10 pole CA727/10	10	10 pole CA727/10	10	10 pole CA727/10	10
	Marking Tag	MT2	1 Pk. (100 tags)	MT2	1 Pk. (100 tags)	MT2

### CDL4U SPACER

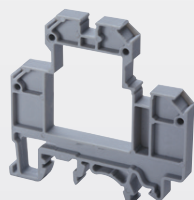

Spacer to cover electronic components which stick out of CDL4U(O)

Cat. No.	Std. Pk.
CDL4USP	50

**CDL4U(E)DD3/DD4**

**CDL4U(E)D4**

**CDL4U(E)DD5**

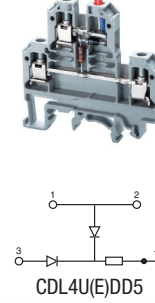
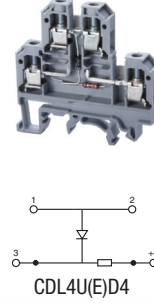
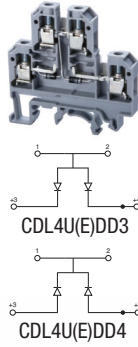

**Dimensions & Weight**

<b>Width</b>	<b>6 mm</b>	<b>6 mm</b>	<b>6 mm</b>
<b>Length</b>	55.5 mm	55.5 mm	55.5 mm
<b>Height w DIN Rail</b>	35 x 7.5 mm 35 x 15 mm	55.7 mm 63.1 mm	55.7 mm 63.1 mm
<b>Weight per piece</b>	13.6 g	13.6 g	13.6 g

**Technical Data/Ratings**

<b>Approvals</b>									
<b>Wire Size (solid / stranded)</b>	22-10 AWG			22-10 AWG			22-10 AWG		
<b>Voltage Rating</b>	600 V	300 V	500 V AC	600 V	300 V	500 V AC	600 V	300 V	500 V AC
<b>Current Rating</b>	35 A	25 A	32 A	35 A	25 A	32 A	35 A	25 A	32 A
<b>Torque</b>	7 lb-in		0.5 Nm	7 lb-in		0.5 Nm	7 lb-in		0.5 Nm
<b>Insulation Material</b>	Polyamide 66			Polyamide 66			Polyamide 66		

**Electronic Component Specifications**

<b>Diode Type</b>	1N 4007	1N 4007	1N 4007
<b>Diode Reverse Voltage / Current</b>	1000 V / 1 A	1000 V / 1 A	1000 V / 1 A
<b>Indicator Voltage</b>	-	-	-

**Installation Instructions**

<b>Wire Stripping Length</b>	9 mm	9 mm	9 mm
<b>Screwdriver</b>	Flat Head 0.6 x 3.5 mm	Flat Head 0.6 x 3.5 mm	Flat Head 0.6 x 3.5 mm

**Terminal Blocks**

<b>Grey</b>	Cat. No.	Std. Pk.	Cat. No.	Std. Pk.	Cat. No.	Std. Pk.
	CDL4U(E)DD3	100	CDL4U(E)D4/12V	100	CDL4U(E)DD5/12V	100
	CDL4U(E)DD4	100	CDL4U(E)D4/24V	100	CDL4U(E)DD5/24V	100

**Accessories**

<b>End Plate</b>	Cat. No.	Std. Pk.	Cat. No.	Std. Pk.	Cat. No.	Std. Pk.	
	EPCDL4U	50	EPCDL4U	50	EPCDL4U	50	
<b>Spacer</b>	CDL4USP	50	CDL4USP	50	CDL4USP	50	
<b>DIN Rail</b>	2511120	20	2511120	20	2511120	20	
	CA701-15/S	20	CA701-15/S	20	CA701-15/S	20	
	2511160	10	2511160	10	2511160	10	
<b>End Stop</b>	CA702	50	CA702	50	CA702	50	
	CA802	50	CA802	50	CA802	50	
<b>Internal Jumper</b>	2 pole	CA727/2	100	CA727/2	100	CA727/2	100
	3 pole	CA727/3	100	CA727/3	100	CA727/3	100
	4 pole	CA727/4	100	CA727/4	100	CA727/4	100
	10 pole	CA727/10	10	CA727/10	10	CA727/10	10
<b>Marking Tag</b>	MT2	1 Pk. (100 tags)	MT2	1 Pk. (100 tags)	MT2	1 Pk. (100 tags)	



### HIGHLIGHTS

#### FEATURES

- Various configurations of Electronic components soldered into **CDL4U** double level terminal block
- Various Indicator options
- AC voltage indicator
- DC voltage indicator
- LED and Neon lamp versions
- 4 connection points for convenient wiring
- Terminal Block with open current bar **CDL4U(O)** can be individually soldered with electronic components
- Spacer **CDL4USP** can be used to cover overlapping components when soldered individually

#### APPLICATIONS

- AC voltage indication
- DC voltage indication

### CDL4U(E)N1

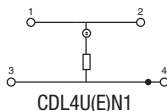
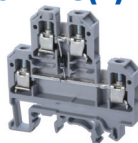

### CDL4U(E)LD5

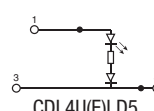

### CDL4U(E)LD3

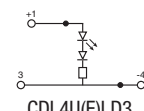

#### Dimensions & Weight

	AC Voltage indicator with Neon lamp	AC Voltage indicator with LED	AC Voltage indicator with LED
Width	6 mm	6 mm	6 mm
Length	55.5 mm	55.5 mm	55.5 mm
Height w DIN Rail	55.7 mm 63.1 mm	55.7 mm 63.1 mm	55.7 mm 63.1 mm
Weight per piece	13.6 g	12.4 g	12.4 g

#### Technical Data/Ratings

Approvals									
Wire Size (solid / stranded)	22-10 AWG 0.2-4 mm <sup>2</sup>			22-10 AWG 0.2-4 mm <sup>2</sup>			22-10 AWG 0.2-4 mm <sup>2</sup>		
Voltage Rating	600 V	300 V	500 V AC	600 V	300 V	500 V AC	600 V	300 V	500 V AC
Current Rating	35 A	25 A	32 A	35 A	25 A	32 A	35 A	25 A	32 A
Torque	7 lb-in		0.5 Nm	7 lb-in		0.5 Nm	7 lb-in		0.5 Nm
Insulation Material	Polyamide 66			Polyamide 66			Polyamide 66		

#### Electronic Component Specifications

Diode Type	1N 4007			1N 4007			1N 4007		
Diode Reverse Voltage / Current	1000 V / 1 A			1000 V / 1 A			1000 V / 1 A		
Indicator Voltage	110, 220 VAC			24, 48, 110, 220 VAC			12, 24 VAC		

#### Installation Instructions

Wire Stripping Length	9 mm			9 mm			9 mm		
Screwdriver	Flat Head 0.6 x 3.5 mm			Flat Head 0.6 x 3.5 mm			Flat Head 0.6 x 3.5 mm		

#### Terminal Blocks

	Cat. No.	Std. Pk.	Cat. No.	Std. Pk.	Cat. No.	Std. Pk.
Grey	<b>CDL4U(E)N1/110V</b>	100	<b>CDL4U(E)LD5/24V</b>	100	<b>CDL4U(E)LD3/12V</b>	100
	<b>CDL4U(E)N1/220V</b>	100	<b>CDL4U(E)LD5/48V</b>	100	<b>CDL4U(E)LD3/24V</b>	100
			<b>CDL4U(E)LD5/110V</b>	100		
			<b>CDL4U(E)LD5/220V</b>	100		

#### Accessories

	Cat. No.	Std. Pk.	Cat. No.	Std. Pk.	Cat. No.	Std. Pk.
End Plate	EPCDL4U	50	EPCDL4U	50	EPCDL4U	50
Spacer	CDL4USP	50	CDL4USP	50	CDL4USP	50
DIN Rail	2511120	20	2511120	20	2511120	20
	CA701-15/S	20	CA701-15/S	20	CA701-15/S	20
	2511160	10	2511160	10	2511160	10
End Stop	CA702	50	CA702	50	CA702	50
	CA802	50	CA802	50	CA802	50
Internal Jumper	2 pole CA727/2	100	2 pole CA727/2	100	2 pole CA727/2	100
	3 pole CA727/3	100	3 pole CA727/3	100	3 pole CA727/3	100
	4 pole CA727/4	100	4 pole CA727/4	100	4 pole CA727/4	100
	10 pole CA727/10	10	10 pole CA727/10	10	10 pole CA727/10	10
	Marking Tag	MT2	1 Pk. (100 tags)	MT2	1 Pk. (100 tags)	MT2

**CDL4U(E)LD1/LD2**

**CDL4U(E)LD4**

**CDL4U(E)L1/L2**

**CDL4U(O)**

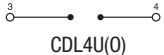
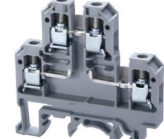
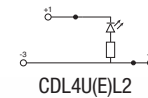
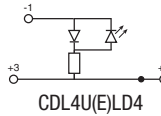
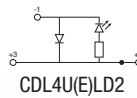
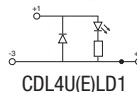

DC Voltage Indicator with LED	AC Voltage indicator with LED	DC Voltage Indicator with LED	Terminal Block with open current to solder custom components
-------------------------------	-------------------------------	-------------------------------	--

**Dimensions & Weight**

<b>Width</b>	<b>6 mm</b>	<b>6 mm</b>	<b>6 mm</b>	<b>6 mm</b>
<b>Length</b>	55.5 mm	55.5 mm	55.5 mm	55.5 mm
<b>Height w/ DIN Rail</b>	35 x 7.5 mm 35 x 15 mm	55.7 mm 63.1 mm	55.7 mm 63.1 mm	55.7 mm 63.1 mm
<b>Weight per piece</b>	12.4 g	12.4 g	12.4 g	13.0 g

**Technical Data/Ratings**

<b>Approvals</b>												
<b>Wire Size (solid / stranded)</b>	22-10 AWG			0.2-4 mm <sup>2</sup>			22-10 AWG			0.2-4 mm <sup>2</sup>		
<b>Voltage Rating</b>	600 V	300 V	500 V AC	600 V	300 V	500 V AC	600 V	300 V	500 V AC	600 V	300 V	500 V AC
<b>Current Rating</b>	35 A	25 A	32 A	35 A	25 A	32 A	35 A	25 A	32 A	35 A	35 A	32 A
<b>Torque</b>	7 lb-in			0.5 Nm			7 lb-in			0.5 Nm		
<b>Insulation Material</b>	Polyamide 66											

**Electronic Component Specifications**

<b>Diode Type</b>	1N 4007	1N 4007	1N 4007	1N 4007
<b>Diode Reverse Voltage / Current</b>	1000 V / 1 A	1000 V / 1 A	1000 V / 1 A	1000 V / 1 A
<b>Indicator Voltage</b>	12, 24 VAC	24, 48 VAC	6, 24 VAC	-

**Installation Instructions**

<b>Wire Stripping Length</b>	9 mm	9 mm	9 mm	9 mm
<b>Screwdriver</b>	Flat Head 0.6 x 3.5 mm	Flat Head 0.6 x 3.5 mm	Flat Head 0.6 x 3.5 mm	Flat Head 0.6 x 3.5 mm

**Terminal Blocks**

<b>Grey</b>	Cat. No.	Std. Pk.	Cat. No.	Std. Pk.	Cat. No.	Std. Pk.	Cat. No.	Std. Pk.
	<b>CDL4U(E)LD1/12V</b>	100	<b>CDL4U(E)LD4/24V</b>	100	<b>CDL4U(E)L1/6V</b>	100	<b>CDL4U(O)</b>	100
	<b>CDL4U(E)LD1/24V</b>	100	<b>CDL4U(E)LD4/48V</b>	100	<b>CDL4U(E)L1/24V</b>	100		
	<b>CDL4U(E)LD2/12V</b>	100			<b>CDL4U(E)L2/6V</b>	100		
	<b>CDL4U(E)LD2/24V</b>	100			<b>CDL4U(E)L2/24V</b>	100		

**Accessories**

<b>End Plate</b>	Cat. No.	Std. Pk.	Cat. No.	Std. Pk.	Cat. No.	Std. Pk.	Cat. No.	Std. Pk.
	EPCDL4U	50	EPCDL4U	50	EPCDL4U	50	EPCDL4U	50
<b>Spacer</b>	CDL4USP	50	CDL4USP	50	CDL4USP	50	CDL4USP	50
<b>DIN Rail</b>	2511120	20	2511120	20	2511120	20	2511120	20
	CA701-15/S	20	CA701-15/S	20	CA701-15/S	20	CA701-15/S	20
	2511160	10	2511160	10	2511160	10	2511160	10
<b>End Stop</b>	CA702	50	CA702	50	CA702	50	CA702	50
	CA802	50	CA802	50	CA802	50	CA802	50
<b>Internal Jumper</b>	CA727/2	100	CA727/2	100	CA727/2	100	CA727/2	100
	CA727/3	100	CA727/3	100	CA727/3	100	CA727/3	100
	CA727/4	100	CA727/4	100	CA727/4	100	CA727/4	100
	CA727/10	10	CA727/10	10	CA727/10	10	CA727/10	10
<b>Marking Tag</b>	MT2	1 Pk. (100 tags)	MT2	1 Pk. (100 tags)	MT2	1 Pk. (100 tags)	MT2	1 Pk. (100 tags)

### HIGHLIGHTS

#### FEATURES

- Various solutions to protect single lines against surges
- Lightning Arrestors (**CDL4U(E)LA**)
- MOVs (**CDL4U(E)MOV**)
- RC Circuits (**CDL4U(E)RC**)
- Suppressor Diode (**CDL4U(E)SD**)

#### APPLICATIONS

- Surge suppressor applications
- Equipment protection

### CDL4U(E)LA

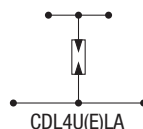
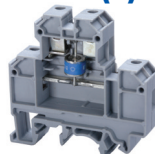

### CDL4U(E)3LA

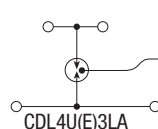
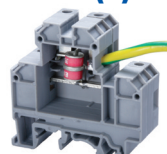

### CDL4U(E)RC

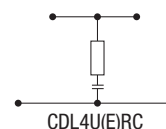

#### Dimensions & Weight

	CDL4U(E)LA	CDL4U(E)3LA	CDL4U(E)RC
Width	18 mm	18 mm	18 mm
Length	55.5 mm	55.5 mm	55.5 mm
Height w DIN Rail	35 x 7.5 mm 35 x 15 mm	55.7 mm 63.1 mm	55.7 mm 63.1 mm
Weight per piece	30.0 g	34.2 g	22.4 g

#### Technical Data/Ratings / Component Specifications

	CDL4U(E)LA	CDL4U(E)3LA	CDL4U(E)RC
Wire Size (solid / stranded)	22-10 AWG	22-10 AWG	22-10 AWG
Insulation Material	Polyamide 66	Polyamide 66	Polyamide 66
Nominal Current	10 A	5 A	-
Peak Current	-	-	2kA-6.5kA (8/20μs)
Nominal Discharge Current	20 KA (8/20μs)	10 KA (8/20μs)	-
Response Time	100 ns	100 ns	< 25 ns
Capacitance	< 1.5 pf	< 1.0 pf	100 - 20,000 pf
Voltage Rating	75, 90, 230, 600, 1000 V DC	90, 230, 350, 600 V DC	30, 60, 75, 130, 275, 460, 510, 625, 680 V AC

#### Installation Instructions

	CDL4U(E)LA	CDL4U(E)3LA	CDL4U(E)RC
Wire Stripping Length	9 mm	9 mm	9 mm
Screwdriver	Flat Head 0.6 x 3.5 mm	Flat Head 0.6 x 3.5 mm	Flat Head 0.6 x 3.5 mm

#### Terminal Blocks

	Cat. No.	Std. Pk.	Cat. No.	Std. Pk.	Cat. No.	Std. Pk.
Grey	<b>CDL4U(E)LA/75V</b>	<b>20</b>	<b>CDL4U(E)3LA/90V</b>	<b>20</b>	<b>0.1 μF</b>	<b>10</b>
	<b>CDL4U(E)LA/90V</b>	<b>20</b>	<b>CDL4U(E)3LA/230V</b>	<b>20</b>	<b>CDL4U(E)RC0.1</b>	<b>10</b>
	<b>CDL4U(E)LA/230V</b>	<b>20</b>	<b>CDL4U(E)3LA/350V</b>	<b>20</b>	<b>0.22 μF</b>	<b>10</b>
	<b>CDL4U(E)LA/600V</b>	<b>20</b>	<b>CDL4U(E)3LA/600V</b>	<b>20</b>	<b>CDL4U(E)RC0.22</b>	<b>10</b>
	<b>CDL4U(E)LA/1000V</b>	<b>20</b>				

#### Accessories

	Cat. No.	Std. Pk.	Cat. No.	Std. Pk.	Cat. No.	Std. Pk.
End Plate	EPCDL4U	50	EPCDL4U	50	EPCDL4U	50
Spacer	CDL4USP	50	CDL4USP	50	CDL4USP	50
DIN Rail	2511120	20	2511120	20	2511120	20
	CA701-15/S	20	CA701-15/S	20	CA701-15/S	20
	2511160	10	2511160	10	2511160	10
End Stop	CA702	50	CA702	50	CA702	50
	CA802	50	CA802	50	CA802	50
Marking Tag	MT2	1 Pk. (100 tags)	MT2	1 Pk. (100 tags)	MT2	1 Pk. (100 tags)

**CDL4U(E)MOV**

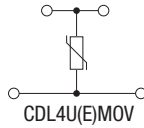

**CTLG2.5(E)MOV**

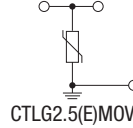
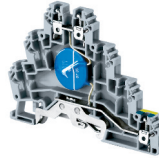

**CDL4U(E)SD**

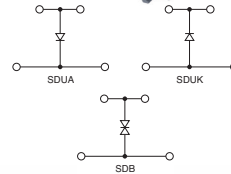
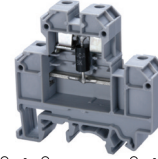

**Dimensions & Weight**

	MOV for voltage surge spike protection	MOV for voltage surge spike protection	Suppressor Diode to fine protect sensors, contacts, etc
<b>Width</b>	<b>12 mm</b>	<b>6 mm</b>	<b>12 mm</b>
<b>Length</b>	55.5 mm	87.5 mm	55.5 mm
<b>Height w DIN Rail</b>	55.7 mm 63.1 mm	66.0 mm 74.0 mm	55.7 mm 63.1 mm
<b>Weight per piece</b>	19.2 g	14.8 g	18.0 g

**Technical Data/Ratings / Component Specifications**

<b>Wire Size (solid / stranded)</b>	22-10 AWG	22-10 AWG	22-10 AWG
<b>Insulation Material</b>	Polyamide 66	Polyamide 66	Polyamide 66
<b>Nominal Current</b>	-	5 A	-
<b>Peak Current</b>	2kA-6.5kA (8/20µs)	2kA-6.5kA (8/20µs)	-
<b>Nominal Discharge Current</b>	-	10 KA (8/20µs)	1.5 KA
<b>Response Time</b>	< 25 ns	< 25 ns	1 ns (D.C) / 5 ns (A.C)
<b>Capacitance</b>	100 - 20,000 pf	100 - 20,000 pf	-
<b>Voltage Rating</b>	30, 60, 75, 130, 275, 460, 510, 625, 680 V AC	Up to 275V	30, 60, 75, 130, 275, 460, 510, 625, 680 V AC

**Installation Instructions**

<b>Wire Stripping Length</b>	9 mm	9 mm	9 mm
<b>Screwdriver</b>	Flat Head 0.6 x 3.5 mm	Flat Head 0.6 x 3.5 mm	Flat Head 0.6 x 3.5 mm

**Terminal Blocks**

	Cat. No.	Std. Pk.	Cat. No.	Std. Pk.	Cat. No.	Std. Pk.
<b>Grey</b>	<b>CDL4U(E)MOV30V</b>	20	<b>CTLG2.5(E)MOV30V</b>	20	<b>DC - Anode</b>	
	<b>CDL4U(E)MOV60V</b>	20	<b>CTLG2.5(E)MOV60V</b>	20	<b>CDL4U(E)SDUA12VDC</b>	20
	<b>CDL4U(E)MOV75V</b>	20	<b>CTLG2.5(E)MOV75V</b>	20	<b>CDL4U(E)SDUA24VDC</b>	20
	<b>CDL4U(E)MOV130V</b>	20	<b>CTLG2.5(E)MOV130V</b>	20	<b>CDL4U(E)SDUA48VDC</b>	20
	<b>CDL4U(E)MOV275V</b>	20	<b>CTLG2.5(E)MOV275V</b>	20	<b>DC - Cathode</b>	
	<b>CDL4U(E)MOV460V</b>	20			<b>CDL4U(E)SDUK12VDC</b>	20
	<b>CDL4U(E)MOV510V</b>	20			<b>CDL4U(E)SDUK24VDC</b>	20
	<b>CDL4U(E)MOV625V</b>	20			<b>CDL4U(E)SDUK48VDC</b>	20
	<b>CDL4U(E)MOV680V</b>	20			<b>AC</b>	
					<b>CDL4U(E)SDB12VAC</b>	
				<b>CDL4U(E)SDB24VAC</b>		
				<b>CDL4U(E)SDB48VAC</b>		
				<b>CDL4U(E)SDB160VAC</b>		

**Accessories**

	Cat. No.	Std. Pk.	Cat. No.	Std. Pk.	Cat. No.	Std. Pk.
<b>End Plate</b>	EPCDL4U	50	EPCTLG2.5	50	EPCDL4U	50
<b>Spacer</b>	CDL4USP	50	-	-	CDL4USP	50
<b>DIN Rail</b>	2511120 CA701-15/S 2511160	20 20 10	2511120 CA701-15/S 2511160	20 20 10	2511120 CA701-15/S 2511160	20 20 10
<b>End Stop</b>	CA702 CA802	50 50	CA702 CA802	50 50	CA702 CA802	50 50
<b>Marking Tag</b>	MT2	1 Pk. (100 tags)	MT2	1 Pk. (100 tags)	MT2	1 Pk. (100 tags)

# ACCESSORIES

## SCREW TERMINAL BLOCKS

## JUMPER / SHORTING LINKS

### Internal Jumper



### Insulated Internal Jumper



### External Jumper



### Current Bar



### Shorting Sleeve & Screws



	Poles	Cat. No.	Std. Pk.	Cat. No.	Std. Pk.	Cat. No.	Std. Pk.	Cat. No.	Std. Pk.	Cat. No.	Std. Pk.		
<b>CTS2.5U-N</b>	2 Pole	CA721/2	100	CA741/2	100	CA717/2	100	CA703/01	100	CA707/S/Q/01	100		
	3 Pole	CA721/3	100	CA741/3	100	CA717/3	100	CA704/01	100				
	4 Pole	CA721/4	100	CA741/4	100	CA717/4	100	CA705/01	100				
	10 Pole	CA721/10	10	CA741/10	10	CA717/10	20	CA731/10	100				
	100 Pole	CA721/100	10	CA741/100	10	-	-	CA731/100	10				
<b>CTS4U-N, CCC4U, CMC1-2, CMC2-2, CDL4UN, CDL4U(I.S), CDLG4, CDLG(I.S), CF4SP, CF4SP(L), CKT4U<sup>1</sup>, CKT4SP</b>	2 Pole	CA722/2	100	CA742/2	100	CA714/2	100	CA703/1	100	CA707/S/Q/01	100		
	3 Pole	CA722/3	100	CA742/3	100	CA714/3	100	CA704/1	100				
	4 Pole	CA722/4	100	CA742/4	100	CA714/4	100	CA705/1	100				
	10 Pole	CA722/10	10	CA742/10	10	CA714/10	20	CA732/10	100				
	100 Pole	CA722/100	10	CA742/100	10	-	-	CA732/100	10				
<b>CTS6U, CDS6U CDTTU<sup>1</sup>, CDTTU-SH<sup>1</sup></b>	2 Pole	CA723/2	100	CA743/2	100	CA710/2	100	CA703/2	100	CA707/S/Q/1	100		
	3 Pole	CA723/3	50	CA743/3	50	CA710/3	50	CA704/2	100				
	4 Pole	CA723/4	50	CA743/4	50	CA710/4	50	CA705/2	100				
	10 Pole	CA723/10	10	CA743/10	10	CA710/10	20	CA733/10	10				
	2 Pole	CA724/2	100	CA744/2	100	CA718/2	100	CA703/3	100				
<b>CTS10U</b>	3 Pole	CA724/3	50	CA744/3	50	CA718/3	50	CA704/3	100	CA707/S/Q/1	100		
	4 Pole	CA724/4	50	CA744/4	50	CA718/4	50	CA705/3	100				
	10 Pole	CA724/10	10	CA744/10	10	CA718/10	20	CA734/10	10				
	2 Pole	CA751/2	50	CA761/2	50	-	-	CA703/8	100			CA707/S/Q/1	100
	3 Pole	CA751/3	50	CA761/3	50	-	-	CA704/8	100				
4 Pole	CA751/4	50	CA761/4	50	-	-	CA705/8	100					
10 Pole	CA751/10	10	CA761/10	10	-	-	CA739/10	10					
2 Pole	CA725/2	50	CA745/2	50	-	-	CA703/4	100	CA707/S/Q/2	100			
3 Pole	CA725/3	20	CA745/3	20	-	-	CA704/4	100					
4 Pole	CA725/4	20	CA745/4	20	-	-	CA705/4	100					
10 Pole	CA725/10	10	CA745/10	10	-	-	CA735/10	100					
2 Pole	CA771/2	50	CA781/2	50	-	-	CA703/10	100			CA707/S/Q/2	100	
3 Pole	CA771/3	20	CA781/3	20	-	-	CA704/10	100					
4 Pole	CA771/4	20	CA781/4	20	-	-	CA705/10	100					
10 Pole	CA771/10	10	CA781/10	10	-	-	CA770/10	10					
2 Pole	CA628/2	10	-	-	-	-	-	-	-	-			-
3 Pole	CA628/3	10	-	-	-	-	-	-	-	-	-		
2 Pole	CA629/2	10	-	-	-	-	-	-	-	-	-		
3 Pole	CA629/3	10	-	-	-	-	-	-	-	-	-		
2 Pole	CA722/2	100	-	-	CA715/2	100	CA703/1	100	CA707/S/Q/01	100			
3 Pole	CA722/3	100	-	-	CA715/3	100	CA704/1	100					
4 Pole	CA722/4	100	-	-	CA715/4	100	CA705/1	100					
10 Pole	CA722/10	10	-	-	CA715/10	20	CA732/10	100					
100 Pole <sup>2</sup>	CA722/100	10	-	-	-	-	CA732/100	10					
2 Pole	CA727/2	100	CA747/2	100	CA714/2	100	CA703/1	100	CA607/S/Q	100			
3 Pole	CA727/3	100	CA747/3	100	CA714/3	100	CA704/1	100					
4 Pole	CA727/4	100	CA747/4	100	CA714/4	100	CA705/1	100					
10 Pole	CA727/10	10	CA747/10	10	CA714/10	20	CA732/10	100					
100 Pole <sup>2</sup>	CA727/100	10	CA747/100	10	-	-	CA732/100	10					
2 Pole	CA627/2	100	-	-	CA715/2	100	CA703/1	100	CA611/S/Q	100			
3 Pole	CA627/3	100	-	-	CA715/3	100	CA704/1	100					
4 Pole	CA627/4	100	-	-	CA715/4	100	CA705/1	100					
10 Pole	CA627/10	10	-	-	CA715/10	20	CA732/10	10					
2 Pole	-	-	-	-	CA711/2	100	-	-			-	-	
3 Pole	-	-	-	-	CA711/3	50	-	-	-	-			
4 Pole	-	-	-	-	CA711/4	50	-	-	-	-			
10 Pole	-	-	-	-	CA711/10	20	-	-	-	-			
2 Pole	CA729/2	100	CA749/2	100	CA711/2	100	CA703/6	100	CA707/S/Q/3	100			
3 Pole	CA729/3	50	CA749/3	50	CA711/3	50	CA704/6	100					
4 Pole	CA729/4	50	CA749/4	50	CA711/4	50	CA705/6	100					
10 Pole	CA729/10	10	CA749/10	10	CA711/10	20	CA737/10	100					
2 Pole	-	-	-	-	CA716/2	50	-	-			-	-	
3 Pole	-	-	-	-	CA716/3	50	-	-	-	-			
4 Pole	-	-	-	-	CA716/4	50	-	-	-	-			
10 Pole	-	-	-	-	CA716/10	20	-	-	-	-			
2 Pole	CA623/2	100	-	-	-	-	-	-	-	-			
3 Pole	CA623/3	100	-	-	-	-	-	-	-	-			
4 Pole	CA623/4	100	-	-	-	-	-	-	-	-			
10 Pole	CA623/10	10	-	-	-	-	-	-	-	-			
2 Pole	CA624/2	100	-	-	-	-	-	-	-	-			
3 Pole	CA624/3	100	-	-	-	-	-	-	-	-			
4 Pole	CA624/4	100	-	-	-	-	-	-	-	-			
10 Pole	CA624/10	10	-	-	-	-	-	-	-	-			
2 Pole	CA625/2	100	-	-	-	-	-	-	-	-			
3 Pole	CA625/3	100	-	-	-	-	-	-	-	-			
4 Pole	CA625/4	100	-	-	-	-	-	-	-	-			
10 Pole	CA625/10	10	-	-	-	-	-	-	-	-			

<sup>1</sup> Internal shorting system not available.

<sup>2</sup> 100 pole strip is breakable into any number of poles needed.



ENDPLATES



Terminal Block	Cat. No.	Dimensions	Std. Pk.
<b>CTS2.5U-N, CTS4U-N</b>	EP2.5/4UN	32 x 39 x 1.5mm	50
<b>CTT2.5UK/J/T/E</b>			
<b>CCTS6U, CTS10U</b>	EP6/10U	31 x 42.5 x 1.5mm	50
<b>CMC1-2</b>	EPCMC1-2	35.5 x 46.5 x 2.5mm	50
<b>CMC2-2, CMCG4</b>	EPCMC2-2	40.5 x 65 x 2.5mm	50
<b>CDL4UN, CDLG4</b>	EPCDL4UN	47.5 x 57 x 1.5mm	50
<b>CDLG2.5</b>	EPCDLG2.5	48 x 71.4 x 1.2mm	50
<b>CTLG2.5</b>	EPCTLG2.5	62.5 x 87.5 x 1.2mm	50
<b>ODL4U</b>	EPODL4U (Front)	49 x 86 x 5.5mm	50
	EP10DL4U (Back)	24 x 68 x 3mm	50
<b>CHV Series, CTSUSC Series</b>	EPUSC	52 x 48.5 x 1.5mm	50
<b>CTL2.5U Series</b>	EPCTL2.5U	55.5 x 84 x 1.5mm	50
<b>CTL2.5U-H Series</b>	EPCTL2.5U-H	55.5 x 61 x 1.5mm	50
<b>CAFL4U Series</b>	EPCAF4U	32 x 72 x 1.5mm	50
<b>CDS6U</b>	EPCDS6U	37.2 x 82 x 1.5mm	50
<b>CKT4U</b>	EPCKT4U	30.5 x 46.5 x 2.5mm	50
<b>EPCKT4U</b>	EPCKT4U/4	65 x 38.3 x 1.5mm	50
<b>CDTTU Series</b>	EPCDTTU	41 x 63 x 3mm	50
<b>CSDL4U</b>	EPCSFL4U	28 x 55.5 x 1.6mm	50
<b>DDDL4U, DDFL4U</b>	EPDDL4U	49 x 87.6 x 3mm	50
<b>CDL4U(E)</b>	EPCDL4U	43 x 55 x 2.4mm	50
<b>CTC4U</b>	EPCTC4U	34.5 x 47 x 2.5mm	50
<b>CMT4</b>	EPCMT4	23 x 27 x 1.5mm	50
<b>CMB4</b>	EPCMB4	27 x 27 x 7mm	50
<b>ODL2.5 Series</b>	EPODL2.5	49 x 59 x 4.6mm	50
	EP10DL2.5	23 x 59 x 2.5mm	50

PARTITION PLATES

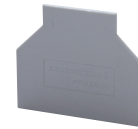

Terminal Block	Cat. No.	Dimensions	Std. Pk.
<b>CTS2.5U-N, CTS4U-N</b>	PP2.5/4UN	37 x 44 x 1.6mm	50
<b>CTT2.5UK/J/T/E</b>			
<b>CTS6U, CTS10U</b>	PP6/10U	37.5 x 56 x 1.5mm	50
<b>CTS25UN</b>	PP25UN	42.5 x 62 x 1mm	50
<b>CTS35UN</b>	PP35UN	50 x 64.5 x 1mm	50
<b>CMT4</b>	PPCMT4	32 x 37 x 1.6mm	50

SEPARATOR PLATES



Terminal Block	Cat. No.	Dimensions	Std. Pk.
<b>CTS2.5U-N, CTS4U-N</b>	SP2.5/4UN	17.5 x 17.4 x 1.4mm	100
<b>CTT2.5UK/J/T/E</b>			
<b>CTS6U, CTS10U, CTS16U</b>	SP6/10U	15.4 x 16.2 x 1.5mm	100
<b>CSL4UN, CDL4UN(I.S.)</b>	SPCDL4U	15.4 x 16.2 x 1.6mm	100
<b>CBM4</b>	SPCMB4	14.5 x 12 x 1.5mm	100
<b>CDLG2.5</b>	SPCDLG2.5	11 x 10.5 x 1	100

END STOPS

CA202



Cat. No.	Dimensions	Std. Pk.
CA202	44.5 x 50 x 9.5mm	50

CA802



Cat. No.	Dimensions	Std. Pk.
CA802	45 x 32 x 8mm	50

CA702



Cat. No.	Dimensions	Std. Pk.
CA702	34 x 45 x 9mm	50

CA102

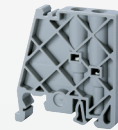

Cat. No.	Dimensions	Std. Pk.
CA102	80 x 46 x 9mm	50

PROTECTIVE COVER

CTSPC COVER

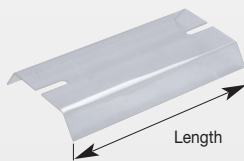

Cat. No.	Length	Std. Pk.
CTSPC/40	40mm	2
CTSPC/90	90mm	2
CTSPC/100	100mm	2
CTSPC/130	130mm	2
CTSPC/150	150mm	2
CTSPC/200	200mm	2
CTSPC/300	300mm	2
CTSPC/330	330mm	2

SUPPORT PLATE

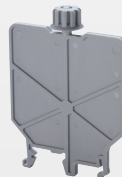

Cat. No.	Std. Pk.
CSP1	50

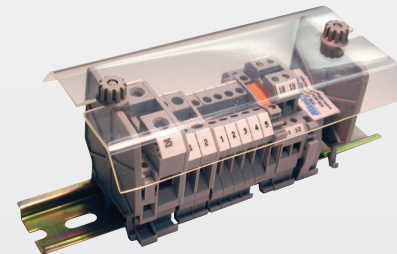

Assembled Block installed with Protective Cover

## X-ON Electronics

Largest Supplier of Electrical and Electronic Components

*Click to view similar products for [Circuit Breaker Accessories](#) category:*

*Click to view products by [Altech](#) manufacturer:*

Other Similar products are found below :

[CSC-403PS](#) [8T1-D-11A](#) [8T1-E-125](#) [NEB10](#) [8T1-E-275](#) [8T1-E-278](#) [506-11315-001](#) [3803221](#) [X10506BF](#) [9-1393249-0](#) [XFPB-4](#) [30.329](#)  
[X22261102](#) [CX2.5/4/O](#) [618.6335.069](#) [BAC03](#) [JX2.5/4](#) [JX2.5/5](#) [HSP6/10U](#) [DB16/BU](#) [932146100](#) [930120000](#) [601.1231.909](#) [600.6101.036](#)  
[3PRG1](#) [3PLBR4LU](#) [3803241](#) [351.5900.149](#) [311.2850.340](#) [2624.0](#) [17BSSV](#) [1-1423696-8](#) [X20080104](#) [LS3-WH](#) [BAC12](#) [Y30028402](#) [30.617](#)  
[8T1-E-114](#) [SF06-5,08](#) [PLLA3](#) [G32S22](#) [2LP199](#) [ZG20-2](#) [3PSML401](#) [3PSML402](#) [2LP219](#) [930109101](#) [930122000](#) [930435101](#) [PAM-1](#)