

Altech Corp.®



Quality
Endorsed
Company

Features

- Small size
- Universal input
- Three-year Warranty



Class II Isolation



Low Profile Power Supplies

PSD-15 Series

FEATURES

- High Efficiency
- 100% Full Load Burn-In
- Low Ripple & Noise
- Adjustable DC Voltage Output
- Class II Isolation Level
- UL62368-1 and CAN / CSA C22.2
- Protections: Overload / Over Voltage / Short Circuit
- Three-year Warranty



Input: 90-240VAC 50/60Hz
 Output Voltage: 5V-48V DC
 Rated Power: 15W max.



CATALOG NUMBER

PSD-1505

PSD-1512

PSD-1515

PSD-1524

PSD-1548

INPUT

Input Voltage	90-264VAC				
Input Frequency	47-63Hz				
Inrush Current	25 Amps max. at 115VAC/60Hz, Full Load & 45Amps max. at 240VAC/50Hz, Full Load				
AC Current	0.5A/115VAC 0.25A/230VAC				
Leakage Current (MAX)	<0.25mA/240VAC				
Efficiency	79%	85%	85%	86%	87%

OUTPUT

DC Voltage	5V	12V	15V	24V	48V
Rated Current	2A	1.25A	1A	0.63A	0.32A
Rated Power	10W	15W	15W	15W	15W
Ripple and Noise	80mVp-p	120mVp-p	120mVp-p	150mVp-p	240mVp-p
Line Regulation	±1%				
Load Regulation	±1%				
Setup, Rise, Hold Up Time	2S/ 80mS/ 15mS (115V/60HZ MAX ROAD); 1S/ 80mS/ 30mS (230V/50HZ MAX ROAD)				

ENVIRONMENTAL

Operating Temperature	-20°C to 50°C, Full Load, Normal Operation
Storage Temperature	-40°C to 80°C
Storage Humidity	10 ~ 95% RH
Working Humidity	20% ~ 90% RH Non-Condensing

PROTECTIONS

Overload Protection	>130%-200% Rated Output Power Protection type: Hiccup Mode- recovers automatically after fault condition is removed
Over Voltage Protection	110~145% Protection Type: Clamp by Zener diode
Short Circuit Protection	Protection to Zero Voltage
Over Current Protection	110%-180%

SAFETY & EMC

Safety Regulations	UL60950-1, UL508, BSMI CNS14336-1, TUV EN61558-2-16 IEC60950-1, EAC TPTC 004, TUV EN60950-1 UL62368-1 and CAN / CSA C22.2 No.62368-1-14
Withstand Voltage	I/P-O/P: 3KVAC
Isolation Resistance	I/P-O/P: 100M Ohms / 500VDC / 25 / 70% RH
EMC Emission	EN55032(CISPR32), CNS13438 Class B, EN61000-3-2 Class A, EN61000-3-3, EN61000-4-2,3,4,5,6,8,11, EN55024, EN55035, EN61000-6-2, EN61204-3

OTHER

MTBF	200,000 Hours Minimum at Full Load at 25°C Ambient
Size	90 x 18 x 58mm
Weight	78g / pcs
Packaging	100PCS/CTN

Mechanical Specification

Pin #	Assignment	Pin #	Assignment
1	+V	3	AC / N
2	-V	4	AC / L

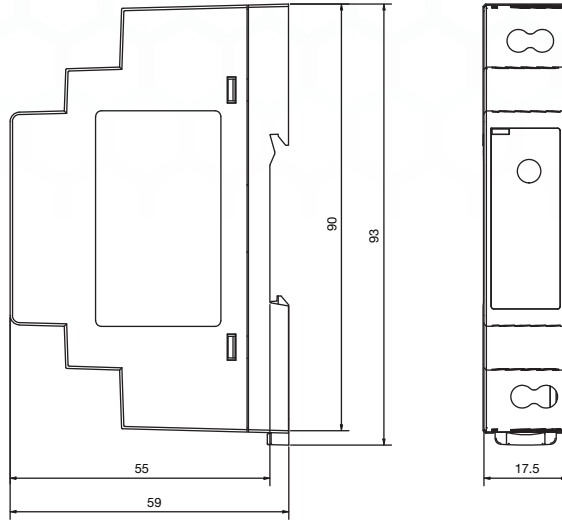

Block Diagram

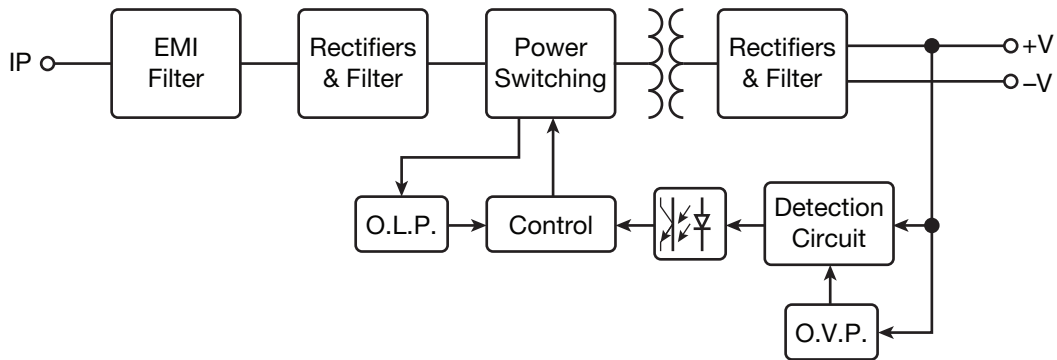

Deduction Curve and Temperature:

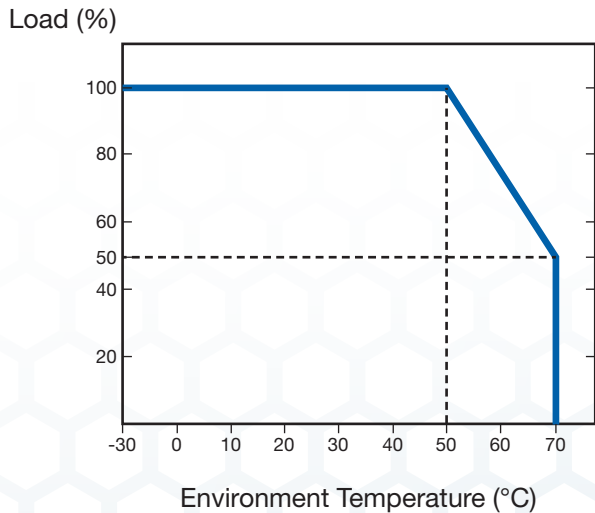

Minus Output and Input Voltage Curves:

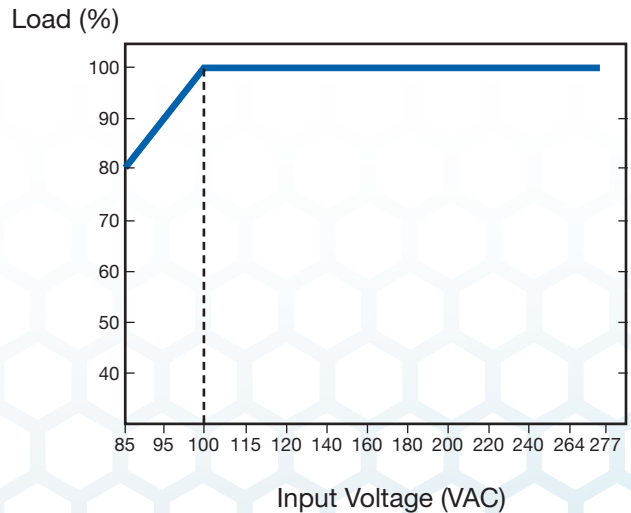

PSD-30 Series

FEATURES

- High Efficiency
- 100% Full Load Burn-In
- Low Ripple & Noise
- Adjustable DC Voltage Output
- Class II Isolation Level
- UL62368-1 and CAN / CSA C22.2
- Protections: Overload / Over Voltage / Short Circuit
- Three-year Warranty



Input: 90-240VAC 50/60Hz
Output Voltage: 5V-48V DC
Rated Power: 30W max.



CATALOG NUMBER

PSD-3005

PSD-3012

PSD-3015

PSD-3024

PSD-3048

INPUT

Input Voltage	90-264VAC				
Input Frequency	47-63Hz				
Inrush Current	25 Amps max. at 115VAC/60Hz, Full Load & 45Amps max. at 240VAC/50Hz, Full Load				
AC Current	0.88A/115VAC 0.48A/230VAC				
Leakage Current (MAX)	<0.25mA/240VAC				
Efficiency	82%	88%	89%	89%	90%

OUTPUT

DC Voltage	5V	12V	15V	24V	48V
Rated Current	3A	2A	2A	1A	0.6A
Rated Power	15W	24W	30W	24W	29W
Ripple and Noise	80mVp-p	120mVp-p	120mVp-p	150mVp-p	240mVp-p
Line Regulation	±1%				
Load Regulation	±1%				
Setup, Rise, Hold Up Time	500mS/ 50mS/ 12mS (115V/60HZ MAX ROAD) 500mS/ 50mS/ 30mS (230V/50HZ MAX ROAD)				

ENVIRONMENTAL

Operating Temperature	-20°C to 50°C, Full Load, Normal Operation
Storage Temperature	-40°C to 80°C
Storage Humidity	10 ~ 95% RH
Working Humidity	20% ~ 90% RH Non-Condensing

PROTECTIONS

Overload Protection	>130%-200% Rated Output Power Protection type: Hiccup Mode- recovers automatically after fault condition is removed
Over Voltage Protection	110~145% Protection Type: Clamp by Zener diode
Short Circuit Protection	Protection to Zero Voltage
Over Current Protection	110%-180%

SAFETY & EMC

Safety Regulations	UL60950-1, UL508, BSMI CNS14336-1, TUV EN61558-2-16 IEC60950-1, EAC TPTC 004, TUV EN60950-1 UL62368-1 and CAN / CSA C22.2 No.62368-1-14
Withstand Voltage	I/P-O/P: 3KVAC
Isolation Resistance	I/P-O/P: 100M Ohms / 500VDC / 25 / 70% RH
EMC Emission	EN55032 (CISPR32), CNS13438 Class B, EN61000-3-2 Class A, EN61000-3-3, EN61000-4-2,3,4,5,6,8,11, EN55024, EN55035, EN61000-6-2, EN61204-3

OTHER

MTBF	200,000 Hours Minimum at Full Load at 25°C Ambient
Size	90 x 35 x 58mm
Weight	120g / pcs
Packaging	100PCS/CTN

For the latest on Altech Power Supply specifications please visit www.altechcorp.com/power.

Dimensions and Installation:

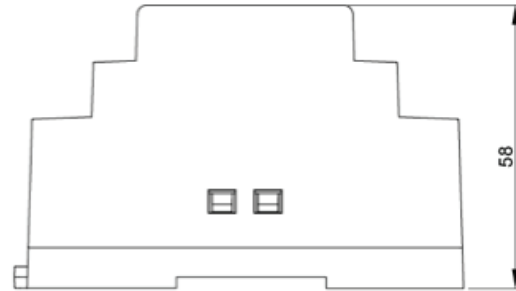
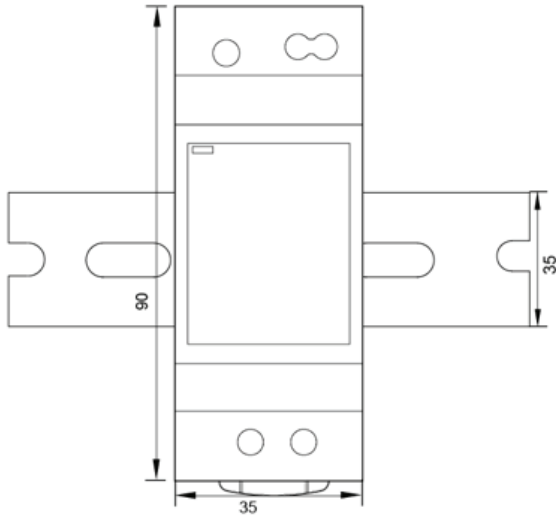

Deduction Curve and Temperature:

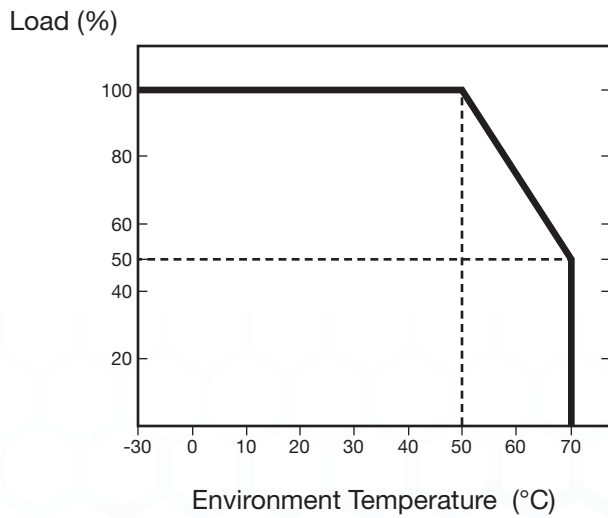

Minus Output and Input Voltage Curves:

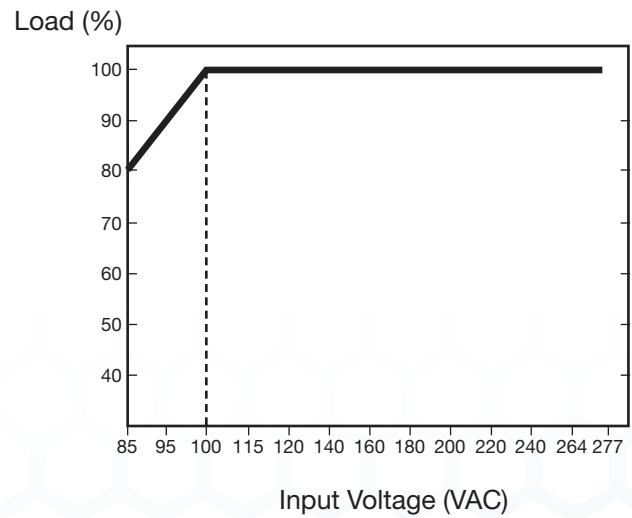

PSD-60 Series

FEATURES

- High Efficiency
- 100% Full Load Burn-In
- Low Ripple & Noise
- Adjustable DC Voltage Output
- Class II Isolation Level
- UL62368-1 and CAN / CSA C22.2
- Protections: Overload / Over Voltage / Short Circuit
- Three-year Warranty

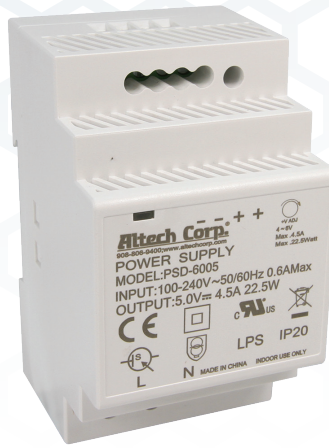

Input: 90-240VAC 50/60Hz
Output Voltage: 5V-48V DC
Rated Power: 60W max.



CATALOG NUMBER

PSD-6005

PSD-6012

PSD-6015

PSD-6024

PSD-6048

INPUT

INPUT	Input Voltage	90-264VAC				
Input Frequency	47-63Hz					
Inrush Current	30Amps max. at 115VAC/60Hz, Full Load & 60Amps max. at 240VAC/50Hz, Full Load					
AC Current	1.2A/115VAC 0.8A/230VAC					
Leakage Current (MAX)	<0.25mA/240VAC					
Efficiency	85%	88%	89%	90%	91%	

OUTPUT

DC Voltage	5V	12V	15V	24V	48V
Rated Current	4.5A	4.5A	4A	2.5A	1.25A
Rated Power	23W	54W	60W	60W	60W
Ripple and Noise	80mVp-p	120mVp-p	120mVp-p	150mVp-p	240mVp-p
Line Regulation	±1%				
Load Regulation	±1%				
Setup, Rise, Hold Up Time	500mS/ 80mS/ 12mS (115V/60HZ MAX ROAD) 500mS/ 80mS/ 30mS (230V/50HZ MAX ROAD)				

ENVIRONMENTAL

Operating Temperature	-20°C to 50°C, Full Load, Normal Operation
Storage Temperature	-40°C to 80°C
Storage Humidity	10 ~ 95% RH
Working Humidity	20% ~ 90% RH Non-Condensing

PROTECTIONS

Overload Protection	>130%-200% Rated Output Power Protection type: Hiccup Mode- recovers automatically after fault condition is removed
Over Voltage Protection	110~145% Protection Type: Clamp by Zener diode
Short Circuit Protection	Protection to Zero Voltage
Over Current Protection	110%-180%

SAFETY & EMC

Safety Regulations	UL60950-1, UL508, BSMI CNS14336-1, TUV EN61558-2-16 IEC60950-1, EAC TPTC 004, TUV EN60950-1 UL62368-1 and CAN / CSA C22.2 No.62368-1-14
Withstand Voltage	I/P-O/P: 3KVAC
Isolation Resistance	I/P-O/P: 100M Ohms / 500VDC / 25 / 70% RH
EMC Emission	EN55032 (CISPR32), CNS13438 Class B, EN61000-3-2 Class A, EN61000-3-3, EN61000-4-2,3,4,5,6,8,11, EN55024, EN55035, EN61000-6-2, EN61204-3

OTHER

MTBF	200,000 Hours Minimum at Full Load at 25°C Ambient
Size	90 x 52.5 x 58mm
Weight	190g / pcs
Packaging	100PCS/CTN

For the latest on Altech Power Supply specifications please visit www.altechcorp.com/power.

Dimensions and Installation:

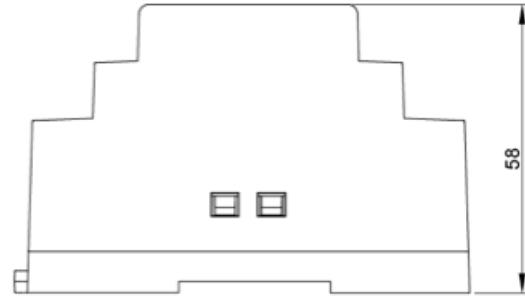
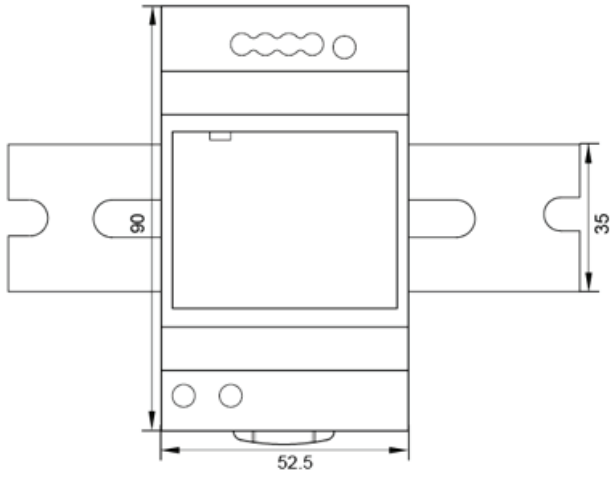

Deduction Curve and Temperature:

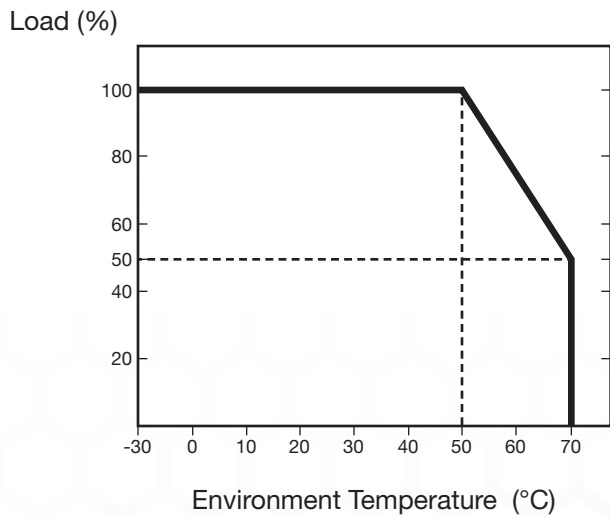

Minus Output and Input Voltage Curves:

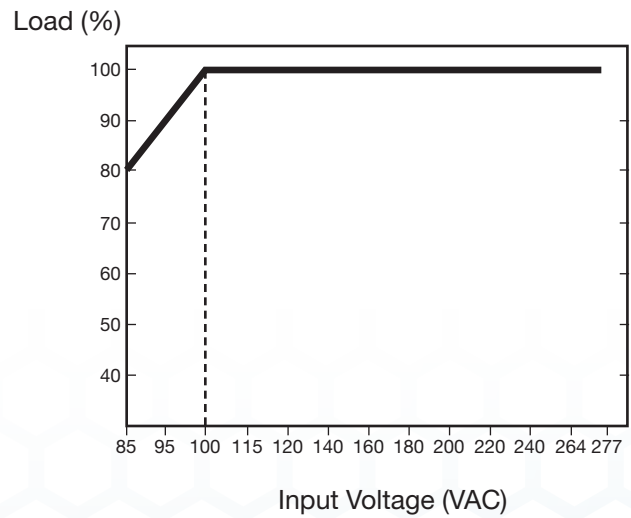

PSD-100 Series

FEATURES

- High Efficiency
- 100% Full Load Burn-In
- Low Ripple & Noise
- Adjustable DC Voltage Output
- Class II Isolation Level
- UL62368-1 and CAN / CSA C22.2
- Protections: Overload / Over Voltage / Short Circuit
- Three-year Warranty



Input: 90-240VAC 50/60Hz
Output Voltage: 5V-48V DC
Rated Power: 100W max.



CATALOG NUMBER

PSD-10012

PSD-10015

PSD-10024

PSD-10048

INPUT

Input Voltage	90-264VAC
Input Frequency	47-63Hz
Inrush Current	35Amps max. at 115VAC/60Hz, Full Load & 70Amps max. at 240VAC/50Hz, Full Load
AC Current	3A/115VAC 1.6A/230VAC
Leakage Current (MAX)	<0.25mA/240VAC
Efficiency	88%

OUTPUT

DC Voltage	12V	15V	24V	48V
Rated Current	7.1A	6.13A	3.8A	2.1A
Rated Power	86W	92W	91W	100W
Ripple and Noise	120mVp-p	120mVp-p	150mVp-p	240mVp-p
Line Regulation	±1%			
Load Regulation	±1%			
Setup, Rise, Hold Up Time	500mS/ 60mS/ 12mS (115V/60HZ MAX ROAD)			
	500mS/ 60mS/ 30mS (230V/50HZ MAX ROAD)			

ENVIRONMENTAL

Operating Temperature	-20°C to 50°C, Full Load, Normal Operation.
Storage Temperature	-40°C to 80°C
Storage Humidity	10 ~ 95% RH
Working Humidity	20% ~ 90% RH Non-Condensing

PROTECTIONS

Overload Protection	>130%-200% Rated Output Power Protection type: Hiccup Mode- recovers automatically after fault condition is removed
Over Voltage Protection	110~145% Protection Type: Clamp by Zener diode
Short Circuit Protection	Protection to Zero Voltage
Over Current Protection	110%-180%

SAFETY & EMC

Safety Regulations	UL60950-1, UL508, BSMI CNS14336-1, TUV EN61558-2-16 IEC60950-1, EAC TPTC 004, TUV EN60950-1 UL62368-1 and CAN / CSA C22.2 No.62368-1-14
Withstand Voltage	I/P-O/P: 3KVAC
Isolation Resistance	I/P-O/P: 100M Ohms / 500VDC / 25 / 70% RH
EMC Emission	EN55032 (CISPR32), CNS13438 Class B, EN61000-3-2 Class A, EN61000-3-3, EN61000-4-2,3,4,5,6,8,11, EN55024, EN55035, EN61000-6-2, EN61204-3

OTHER

MTBF	200,000 Hours Minimum at Full Load at 25°C Ambient
Size	90 x 70 x 58mm
Weight	270g / pcs
Packaging	50 PCS/CTN

For the latest on Altech Power Supply specifications please visit www.altechcorp.com/power.

Mechanical Specification

Pin #	Assignment	Pin #	Assignment
1,2	-V	5	AC / L
3,4	+V	6	AC / N
O	Voltage adjuster		

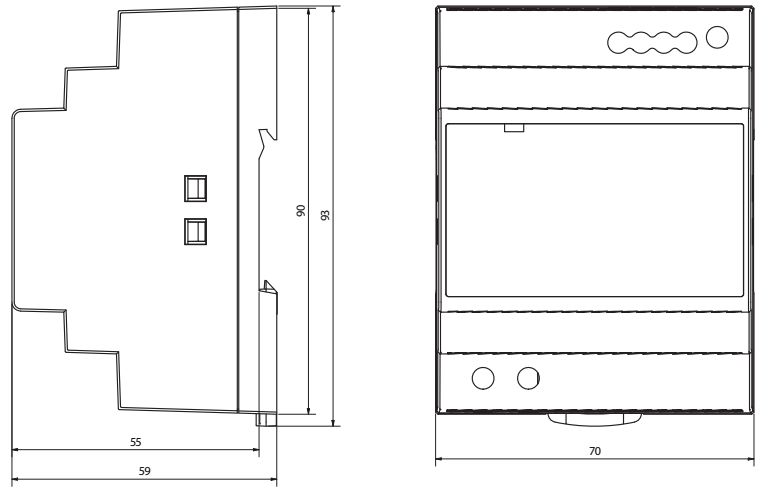

Block Diagram

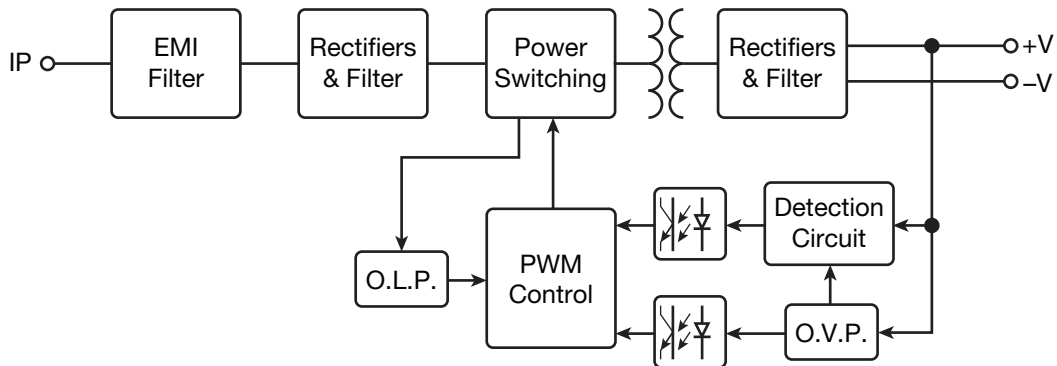

Deduction Curve and Temperature:

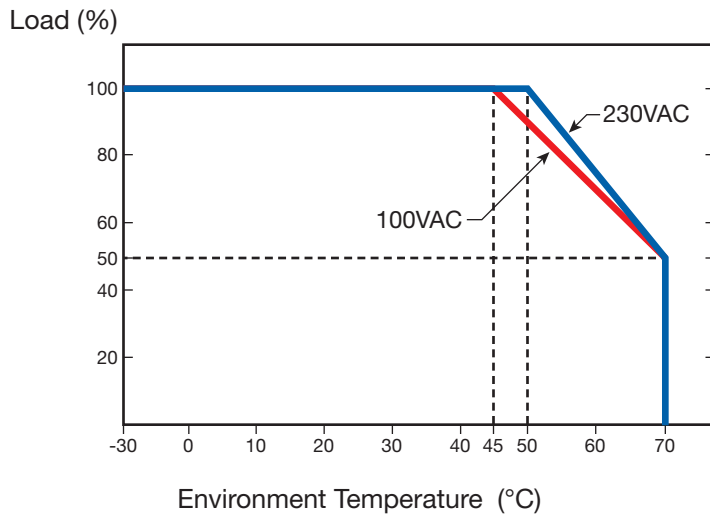

Minus Output and Input Voltage Curves:

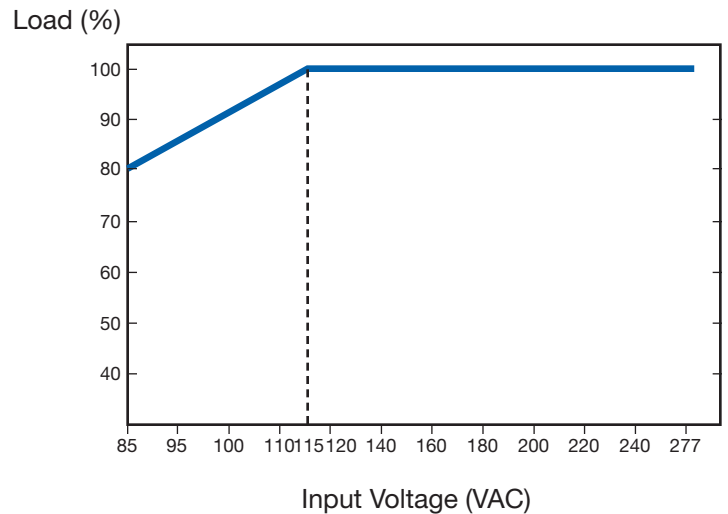



Altech Search

Google



- Home
- Stock Check
- Distributors
- Information
- News
- Contact
- Rep/Dist Login
- Altech Mexico

WEB TOOLS

- Drawings & Photos
- Enclosure Finder
- Altech Videos
- Request for Quote
- Sample Request
- Catalog Request
- Product Crossings
- eBook Catalog

PRODUCT MENU

- ATEX Products
- Circuit Protection/Control >
- Connectors >
- Enclosures >
- Fuses >
- Digital Panel Meters
- Foot Switches
- Interface Modules >
- Panel Accessories
- Power Supplies
- Power Semi-Conductors
- PCB Connection Technology >
- Programmable Controllers
- Push Buttons & Pilot Lights >
- Relays >
- Sensors >
- Safety Switches >
- Standard Switches >
- Solid State Relays
- Terminal Blocks >
- Test & Measurement
- Tower Lights

New Products and Promotions

The NEW

Altech



ENCLOSURE FINDER

Click here to begin

CIRCUIT PROTECTION

	Circuit Protection Devices		Busbar & Power Distribution		Contactors, Overload Relays, Manual Motor Starters		Motor Disconnect Switches		European Fuses & Holders
---	----------------------------	---	-----------------------------	---	--	---	---------------------------	---	--------------------------

CONNECTORS

	Pin & Sleeve Devices		Receptacles
---	----------------------	---	-------------

ENCLOSURES

	Industrial & ATEX Enclosures		DIN Enclosures		Control Enclosures and Suspension Systems
---	------------------------------	---	----------------	---	---

FOOT SWITCHES

	Industrial		Medical
---	------------	---	---------

MODULES & RELAYS

	Interface Modules		Safety Relays		Industrial & Slimline Relays
---	-------------------	---	---------------	---	------------------------------

PANEL ACCESSORIES

	Panel Lights		Heaters, Filters & Thermostats
---	--------------	---	--------------------------------



SPARE PARTS

	European Spare Parts
---	----------------------

PILOT DEVICES

	22 & 30 mm Push Buttons & Enclosures		Pilot Lights & E-Stops
---	--------------------------------------	---	------------------------

POWER DEVICES

	Power Supplies		DC-UPS & Battery Chargers
---	----------------	---	---------------------------



POWER MANAGEMENT

	Altech Smart Relays		Digital Panel Meters		Digital Timers
---	---------------------	---	----------------------	---	----------------



SAFETY SWITCHES

	Keyed Safety Switches		Keyed Solenoid Locking Switches		Hinged Safety Switches		Non-Contact Safety Switches		Safety Rope Pull Switches
---	-----------------------	---	---------------------------------	---	------------------------	---	-----------------------------	---	---------------------------

STANDARD SWITCHES

	Limit Switches		Foot Switches
---	----------------	---	---------------

SENSORS

	Cylindrical & Capacitive		Flat Pack & Ring		Metal Detection
---	--------------------------	---	------------------	---	-----------------

X-ON Electronics

Largest Supplier of Electrical and Electronic Components

Click to view similar products for [DIN Rail Power Supplies](#) category:

Click to view products by [Altech](#) manufacturer:

Other Similar products are found below :

[PS-3015](#) [DVP01PU-S](#) [DVP06AD-S](#) [DVPPS02](#) [PS9Z-5R1G](#) [PS-C24024](#) [ADNB040-24-1PM-C](#) [SS14011524](#) [PSW-12024](#) [S8T-BUS03](#) [PS-S4024](#) [NTPS-24-1.3](#) [PS-10024](#) [PS-C12024](#) [PSP-480S24](#) [PS-C48024](#) [PS-C480P24](#) [PSC-2024](#) [PSC-4012](#) [PSC-4048](#) [PSC-9615](#) [PSC-15124](#) [PSC-15148](#) [PSC-24148](#) [PSC-48148](#) [PSS18/24/0.75](#) [PSS120/24/5](#) [PSD-A120W12](#) [NDR-7524](#) [NDR-12024](#) [AMED15-48SNZ-B](#) [AMED15-5SNZ-B](#) [AMED120-48SJZ](#) [AMED120-24SJZ](#) [AMED15-24SNZ-B](#) [AMED75-48SJZ](#) [1SVR427043R1200](#) [1110466](#) [50995](#) [50903](#) [50997](#)
[EL50-D](#) [18924-9989](#) [50996](#) [HDN-3024](#) [ISEDR-120-24](#) [1335699](#) [1335698](#) [LWR1601-6ER](#) [1170952](#)