

TASKING[®]

***TASKING VX-toolset for ARM
User Guide***

MA101-800 (v5.2) July 24, 2015

Copyright © 2015 Altium BV.

All rights reserved. You are permitted to print this document provided that (1) the use of such is for personal use only and will not be copied or posted on any network computer or broadcast in any media, and (2) no modifications of the document is made. Unauthorized duplication, in whole or part, of this document by any means, mechanical or electronic, including translation into another language, except for brief excerpts in published reviews, is prohibited without the express written permission of Altium BV. Unauthorized duplication of this work may also be prohibited by local statute. Violators may be subject to both criminal and civil penalties, including fines and/or imprisonment. Altium, TASKING, and their respective logos are trademarks or registered trademarks of Altium Limited or its subsidiaries. All other registered or unregistered trademarks referenced herein are the property of their respective owners and no trademark rights to the same are claimed.

Table of Contents

1. C Language	1
1.1. Data Types	1
1.2. Changing the Alignment: <code>__unaligned</code> , <code>__packed__</code> and <code>__align()</code>	2
1.3. Placing an Object at an Absolute Address: <code>__at()</code>	3
1.4. Accessing Hardware from C	4
1.5. Shift JIS Kanji Support	5
1.6. Using Assembly in the C Source: <code>__asm()</code>	6
1.7. Attributes	12
1.8. Pragmas to Control the Compiler	15
1.9. Predefined Preprocessor Macros	21
1.10. Switch Statement	22
1.11. Functions	24
1.11.1. Calling Convention	24
1.11.2. Inlining Functions: <code>inline</code>	24
1.11.3. Interrupt Functions / Exception Handlers	26
1.11.4. Intrinsic Functions	28
2. C++ Language	39
2.1. C++ Language Extension Keywords	39
2.2. C++ Dialect Accepted	39
2.2.1. Default C++ Mode	40
2.2.2. GNU C++ Mode	41
2.2.3. Anachronisms Accepted	42
2.3. Namespace Support	43
2.4. Template Instantiation	45
2.4.1. Instantiation Modes	46
2.4.2. Instantiation <code>#pragma</code> Directives	46
2.4.3. Implicit Inclusion	48
2.5. Inlining Functions	48
2.6. Extern Inline Functions	49
2.7. Pragmas to Control the C++ Compiler	50
2.8. Predefined Macros	50
2.9. Precompiled Headers	54
2.9.1. Automatic Precompiled Header Processing	55
2.9.2. Manual Precompiled Header Processing	58
2.9.3. Other Ways to Control Precompiled Headers	58
2.9.4. Performance Issues	59
3. Assembly Language	61
3.1. Assembly Syntax	61
3.2. Assembler Significant Characters	62
3.3. Operands of an Assembly Instruction	63
3.4. Symbol Names	63
3.4.1. Predefined Preprocessor Symbols	64
3.5. Registers	65
3.6. Assembly Expressions	65
3.6.1. Numeric Constants	66
3.6.2. Strings	66
3.6.3. Expression Operators	67
3.7. Working with Sections	68

3.8. Built-in Assembly Functions	69
3.9. Assembler Directives	74
3.9.1. Overview of Assembler Directives	75
3.9.2. Detailed Description of Assembler Directives	76
3.10. Macro Operations	116
3.10.1. Defining a Macro	116
3.10.2. Calling a Macro	116
3.10.3. Using Operators for Macro Arguments	117
3.11. Generic Instructions	120
3.11.1. ARM Generic Instructions	120
3.11.2. ARM and Thumb-2 32-bit Generic Instructions	121
3.11.3. Thumb 16-bit Generic Instructions	123
4. Using the C Compiler	125
4.1. Compilation Process	125
4.2. Calling the C Compiler	126
4.3. How the Compiler Searches Include Files	128
4.4. Compiling for Debugging	129
4.5. Compiler Optimizations	130
4.5.1. Generic Optimizations (frontend)	131
4.5.2. Core Specific Optimizations (backend)	134
4.5.3. Optimize for Code Size or Execution Speed	135
4.6. Static Code Analysis	139
4.6.1. C Code Checking: CERT C	140
4.6.2. C Code Checking: MISRA C	142
4.7. C Compiler Error Messages	143
5. Using the C++ Compiler	145
5.1. Calling the C++ Compiler	145
5.2. How the C++ Compiler Searches Include Files	147
5.3. C++ Compiler Error Messages	148
6. Using the Assembler	151
6.1. Assembly Process	151
6.2. Assembler Versions	152
6.3. Calling the Assembler	152
6.4. How the Assembler Searches Include Files	153
6.5. Generating a List File	154
6.6. Assembler Error Messages	155
7. Using the Linker	157
7.1. Linking Process	157
7.1.1. Phase 1: Linking	159
7.1.2. Phase 2: Locating	160
7.2. Calling the Linker	161
7.3. Linking with Libraries	162
7.3.1. How the Linker Searches Libraries	165
7.3.2. How the Linker Extracts Objects from Libraries	166
7.4. Incremental Linking	166
7.5. Importing Binary Files	167
7.6. Linker Optimizations	168
7.7. Controlling the Linker with a Script	169
7.7.1. Purpose of the Linker Script Language	169
7.7.2. Eclipse and LSL	170

7.7.3. Structure of a Linker Script File	172
7.7.4. The Architecture Definition	174
7.7.5. The Derivative Definition	176
7.7.6. The Processor Definition	177
7.7.7. The Memory Definition	178
7.7.8. The Section Layout Definition: Locating Sections	179
7.8. Linker Labels	181
7.9. Generating a Map File	182
7.10. Linker Error Messages	183
8. Run-time Environment	185
8.1. Startup Code	185
8.2. Reset Handler and Vector Table	186
8.3. CMSIS Support	190
8.4. Stack and Heap	191
9. Using the Utilities	195
9.1. Control Program	195
9.2. Make Utility amk	197
9.2.1. Makefile Rules	197
9.2.2. Makefile Directives	199
9.2.3. Macro Definitions	199
9.2.4. Makefile Functions	201
9.2.5. Conditional Processing	202
9.2.6. Makefile Parsing	202
9.2.7. Makefile Command Processing	203
9.2.8. Calling the amk Make Utility	204
9.3. Eclipse Console Utility	205
9.3.1. Headless Build	205
9.3.2. Generating Makefiles from the Command Line	206
9.4. Archiver	208
9.4.1. Calling the Archiver	208
9.4.2. Archiver Examples	210
9.5. HLL Object Dumper	212
9.5.1. Invocation	212
9.5.2. HLL Dump Output Format	212
9.6. Expire Cache Utility	218
10. Using the Debugger	219
10.1. Reading the Eclipse Documentation	219
10.2. Creating a Customized Debug Configuration	219
10.3. Troubleshooting	225
10.4. TASKING Debug Perspective	226
10.4.1. Debug View	226
10.4.2. Breakpoints View	228
10.4.3. File System Simulation (FSS) View	230
10.4.4. Disassembly View	230
10.4.5. Expressions View	231
10.4.6. Memory View	231
10.4.7. Compare Application View	232
10.4.8. Heap View	232
10.4.9. Logging View	233
10.4.10. RTOS View	233

10.4.11. Registers View	234
10.4.12. Trace View	235
10.5. Programming a Flash Device	236
11. Tool Options	241
11.1. Configuring the Command Line Environment	247
11.2. C Compiler Options	248
11.3. C++ Compiler Options	322
11.4. Assembler Options	459
11.5. Linker Options	501
11.6. Control Program Options	555
11.7. Parallel Make Utility Options	624
11.8. Archiver Options	638
11.9. HLL Object Dumper Options	653
11.10. Expire Cache Utility Options	675
12. Influencing the Build Time	685
12.1. MIL Linking	685
12.2. Optimization Options	685
12.3. Automatic Inlining	686
12.4. Code Compaction	686
12.5. Compiler Cache	686
12.6. Header Files	687
12.7. Parallel Build	687
12.8. Number of Sections	688
13. Profiling	689
13.1. What is Profiling?	689
13.1.1. Methods of Profiling	689
13.2. Profiling using Code Instrumentation (Dynamic Profiling)	690
13.2.1. Step 1: Build your Application for Profiling	691
13.2.2. Step 2: Execute the Application	693
13.2.3. Step 3: Displaying Profiling Results	695
13.3. Profiling at Compile Time (Static Profiling)	698
13.3.1. Step 1: Build your Application with Static Profiling	698
13.3.2. Step 2: Displaying Static Profiling Results	699
14. Libraries	701
14.1. Using the CMSIS DSP Library	703
14.2. Library Functions	703
14.2.1. assert.h	703
14.2.2. complex.h	704
14.2.3. ctype.h and wctype.h	705
14.2.4. dbg.h	706
14.2.5. errno.h	706
14.2.6. except.h	707
14.2.7. fcntl.h	708
14.2.8. fenv.h	708
14.2.9. float.h	709
14.2.10. inttypes.h and stdint.h	709
14.2.11. io.h	710
14.2.12. iso646.h	710
14.2.13. limits.h	710
14.2.14. locale.h	710

14.2.15. malloc.h	711
14.2.16. math.h and tgmath.h	711
14.2.17. setjmp.h	715
14.2.18. signal.h	716
14.2.19. stdarg.h	716
14.2.20. stdbool.h	717
14.2.21. stddef.h	717
14.2.22. stdint.h	717
14.2.23. stdio.h and wchar.h	717
14.2.24. stdlib.h and wchar.h	725
14.2.25. string.h and wchar.h	728
14.2.26. time.h and wchar.h	730
14.2.27. unistd.h	733
14.2.28. wchar.h	733
14.2.29. wctype.h	734
14.3. C Library Reentrancy	735
15. List File Formats	747
15.1. Assembler List File Format	747
15.2. Linker Map File Format	748
16. Object File Formats	757
16.1. ELF/DWARF Object Format	757
16.2. Intel Hex Record Format	757
16.3. Motorola S-Record Format	760
17. Linker Script Language (LSL)	763
17.1. Structure of a Linker Script File	763
17.2. Syntax of the Linker Script Language	765
17.2.1. Preprocessing	765
17.2.2. Lexical Syntax	766
17.2.3. Identifiers and Tags	766
17.2.4. Expressions	767
17.2.5. Built-in Functions	767
17.2.6. LSL Definitions in the Linker Script File	770
17.2.7. Memory and Bus Definitions	770
17.2.8. Architecture Definition	772
17.2.9. Derivative Definition	775
17.2.10. Processor Definition and Board Specification	776
17.2.11. Section Setup	776
17.2.12. Section Layout Definition	776
17.3. Expression Evaluation	781
17.4. Semantics of the Architecture Definition	782
17.4.1. Defining an Architecture	783
17.4.2. Defining Internal Buses	784
17.4.3. Defining Address Spaces	784
17.4.4. Mappings	788
17.5. Semantics of the Derivative Definition	791
17.5.1. Defining a Derivative	791
17.5.2. Instantiating Core Architectures	792
17.5.3. Defining Internal Memory and Buses	793
17.6. Semantics of the Board Specification	794
17.6.1. Defining a Processor	794

17.6.2. Instantiating Derivatives	795
17.6.3. Defining External Memory and Buses	795
17.7. Semantics of the Section Setup Definition	796
17.7.1. Setting up a Section	797
17.8. Semantics of the Section Layout Definition	798
17.8.1. Defining a Section Layout	799
17.8.2. Creating and Locating Groups of Sections	799
17.8.3. Creating or Modifying Special Sections	805
17.8.4. Creating Symbols	809
17.8.5. Conditional Group Statements	810
18. Debug Target Configuration Files	811
18.1. Custom Board Support	811
18.2. Description of DTC Elements and Attributes	812
18.3. Special Resource Identifiers	814
19. CPU Problem Bypasses and Checks	817
20. CERT C Secure Coding Standard	821
20.1. Preprocessor (PRE)	821
20.2. Declarations and Initialization (DCL)	822
20.3. Expressions (EXP)	823
20.4. Integers (INT)	824
20.5. Floating Point (FLP)	824
20.6. Arrays (ARR)	825
20.7. Characters and Strings (STR)	825
20.8. Memory Management (MEM)	825
20.9. Environment (ENV)	826
20.10. Signals (SIG)	826
20.11. Miscellaneous (MSC)	827
21. MISRA C Rules	829
21.1. MISRA C:1998	829
21.2. MISRA C:2004	833
21.3. MISRA C:2012	841

Chapter 1. C Language

This chapter describes the target specific features of the C language, including language extensions that are not standard in ISO-C. For example, pragmas are a way to control the compiler from within the C source.

The TASKING VX-toolset for ARM® C compiler fully supports the ISO-C standard and adds extra possibilities to program the special functions of the target.

In addition to the standard C language, the compiler supports the following:

- attribute to specify alignment and absolute addresses
- intrinsic (built-in) functions that result in target specific assembly instructions
- pragmas to control the compiler from within the C source
- predefined macros
- the possibility to use assembly instructions in the C source
- keywords for inlining functions and programming interrupt routines
- libraries

All non-standard keywords have two leading underscores (`__`).

In this chapter the target specific characteristics of the C language are described, including the above mentioned extensions.

1.1. Data Types

The TASKING C compiler for the ARM supports the following data types.

C type	Size	Align	Limits
<code>_Bool</code>	1	8	0 or 1
signed char	8	8	$[-2^7, 2^7-1]$
unsigned char	8	8	$[0, 2^8-1]$
short	16	16	$[-2^{15}, 2^{15}-1]$
unsigned short	16	16	$[0, 2^{16}-1]$
int	32	32	$[-2^{31}, 2^{31}-1]$
unsigned int	32	32	$[0, 2^{32}-1]$
enum	32	32	$[-2^{31}, 2^{31}-1]$
long	32	32	$[-2^{31}, 2^{31}-1]$
unsigned long	32	32	$[0, 2^{32}-1]$

C type	Size	Align	Limits
long long	64	64	$[-2^{63}, 2^{63}-1]$
unsigned long long	64	64	$[0, 2^{64}-1]$
float (23-bit mantissa)	32	32	$[-3.402E+38, -1.175E-38]$ $[+1.175E-38, +3.402E+38]$
double long double (52-bit mantissa)	64	64	$[-1.797E+308, -2.225E-308]$ $[+2.225E-308, +1.797E+308]$
_Imaginary float	32	32	$[-3.402E+38i, -1.175E-38i]$ $[+1.175E-38i, +3.402E+38i]$
_Imaginary double _Imaginary long double	64	64	$[-1.797E+308i, -2.225E-308i]$ $[+2.225E-308i, +1.797E+308i]$
_Complex float	64	32	real part + imaginary part
_Complex double _Complex long double	128	64	real part + imaginary part
pointer to data or function	32	32	$[0, 2^{32}-1]$

1.2. Changing the Alignment: `__unaligned`, `__packed` and `__align()`

Normally data, pointers and structure members are aligned according to the table in the previous section.

Suppress alignment

With the type qualifier `__unaligned` you can specify to suppress the alignment of objects or structure members. This can be useful to create compact data structures. In this case the alignment will be one bit for bit-fields or one byte for other objects or structure members.

At the left side of a pointer declaration you can use the type qualifier `__unaligned` to mark the pointer value as potentially unaligned. This can be useful to access externally defined data. However the compiler can generate less efficient instructions to dereference such a pointer, to avoid unaligned memory access.

You can always convert a normal pointer to an unaligned pointer. Conversions from an unaligned pointer to an aligned pointer are also possible. However, the compiler will generate a warning in this situation, with the exception of the following case: when the logical type of the destination pointer is `char` or `void`, no warning will be generated.

Example:

```
struct
{
    char c;
    __unaligned int i; /* aligned at offset 1 ! */
} s;

__unaligned int * up = & s.i;
```

Packed structures

To prevent alignment gaps in structures, you can use the attribute `__packed__`. When you use the attribute `__packed__` directly after the keyword `struct`, all structure members are marked `__unaligned`. For example the following two declarations are the same:

```
struct __packed__
{
    char  c;
    int * i;
} s1;

struct
{
    char  __unaligned c;
    int * __unaligned i; /* __unaligned at right side of '*'
                        to pack pointer member          */
} s2;
```

The attribute `__packed__` has the same effect as adding the type qualifier `__unaligned` to the declaration to suppress the standard alignment.

You can also use `__packed__` in a pointer declaration. In that case it affects the alignment of the pointer itself, not the value of the pointer. The following two declarations are the same:

```
int * __unaligned p;
int * p __packed__;
```

Change alignment

With the attribute `__align(n)` you can overrule the default alignment of objects or structure members to n bytes.

1.3. Placing an Object at an Absolute Address: `__at()`

With the attribute `__at()` you can specify an absolute address.

The compiler checks the address range, the alignment and if an object crosses a page boundary.

Examples

```
unsigned char Display[80*24] __at( 0x2000 );
```

The array `Display` is placed at address `0x2000`. In the generated assembly, an absolute section is created. On this position space is reserved for the variable `Display`.

```
int i __at(0x1000) = 1;
```

The variable `i` is placed at address `0x1000` and is initialized.

TASKING VX-toolset for ARM User Guide

```
void f(void) __at( 0xf0ff + 1 ) { }
```

The function `f` is placed at address `0xf100`.

Restrictions

Take note of the following restrictions if you place a variable at an absolute address:

- The argument of the `__at()` attribute must be a constant address expression.
- You can place only global variables at absolute addresses. Parameters of functions, or automatic variables within functions cannot be placed at absolute addresses.
- A variable that is declared `extern`, is not allocated by the compiler in the current module. Hence it is not possible to use the keyword `__at()` on an external variable. Use `__at()` at the definition of the variable.
- You cannot place structure members at an absolute address.
- Absolute variables cannot overlap each other. If you declare two absolute variables at the same address, the assembler and/or linker issues an error. The compiler does not check this.

1.4. Accessing Hardware from C

It is easy to access Special Function Registers (SFRs) that relate to peripherals from C. The SFRs are defined in a special include file (`*.h`) as symbol names for use with the compiler.

The TASKING VX-toolset for ARM supports the Cortex Microcontroller Software Interface Standard (CMSIS). You can find details about this standard on www.arm.com.

The product includes a full set of CMSIS files in the `cmsis` directory under the product installation directory. This includes SFR files for the various Cortex cores. The organization of the CMSIS files in the product installation is as follows:

<code>cmsis/Device/ARM</code>	CMSIS-CORE files for the supported ARM processors
<code>cmsis/DSP_Lib</code>	DSP Library Collection
<code>cmsis/Include</code>	CMSIS-CORE header files
<code>cmsis/RTOS/Template</code>	Contains the template header file <code>cmsis_os.h</code> for a CMSIS-RTOS compliant RTOS

When you include CMSIS SFR file in your source you must set an include search path to the appropriate CMSIS directory.

Example of including an SFR file:

```
#include "ARMCM3.h"
```

```
void main(void)
{
```

```

    NVIC->ISER[0] = 1;
}

```

Compiler invocation:

```

ccarm -CARMv7M -I"installation_dir\cmsis\Device\ARM\ARMCM3\Include"
      -I"installation_dir\cmsis\Include" file.c

```

When you use Eclipse you can easily add the include search paths by using the option **Project » Properties for » C/C++ Build » Settings » C/C++ Compiler » Add CMSIS include paths.**

1.5. Shift JIS Kanji Support

In order to allow for Japanese character support on non-Japanese systems (like PCs), you can use the Shift JIS Kanji Code standard. This standard combines two successive ASCII characters to represent one Kanji character. A valid Kanji combination is only possible within the following ranges:

- First (high) byte is in the range 0x81-0x9f or 0xe0-0xef.
- Second (low) byte is in the range 0x40-0x7e or 0x80-0xfc

Compiler option **-Ak** enables support for Shift JIS encoded Kanji multi-byte characters in strings and (wide) character constants. Without this option, encodings with 0x5c as the second byte conflict with the use of the backslash ('\') as an escape character. Shift JIS in comments is supported regardless of this option.

Note that Shift JIS also includes Katakana and Hiragana.

Example:

```

// Example usage of Shift JIS Kanji
// Do not switch off option -Ak
// At the position of the italic text you can
// put your Shift JIS Kanji code
int i; // put Shift JIS Kanji here
char c1;
char c2;
unsigned int ui;
const char mes[]="put Shift JIS Kanji here";
const unsigned int ar[5]={'K','a','n',
                          'j','i'};
                          // 5 Japanese array

void main(void)
{
    i=(int)c1;
    i++; /* put Shift JIS Kanji here\
          continuous comment */
    c2=mes[9];
    ui=ar[0];
}

```

1.6. Using Assembly in the C Source: `__asm()`

With the keyword `__asm` you can use assembly instructions in the C source and pass C variables as operands to the assembly code. Be aware that C modules that contain assembly are not portable and harder to compile in other environments.

The compiler does not interpret assembly blocks but passes the assembly code to the assembly source file; they are regarded as a black box. So, it is your responsibility to make sure that the assembly block is syntactically correct. Possible errors can only be detected by the assembler.

You need to tell the compiler exactly what happens in the inline assembly code because it uses that for code generation and optimization. The compiler needs to know exactly which registers are written and which registers are only read. For example, if the inline assembly writes to a register from which the compiler assumes that it is only read, the generated code after the inline assembly is based on the fact that the register still contains the same value as before the inline assembly. If that is not the case the results may be unexpected. Also, an inline assembly statement using multiple input parameters may be assigned the same register if the compiler finds that the input parameters contain the same value. As long as this register is only read this is not a problem.

General syntax of the `__asm` keyword

```
__asm( "instruction_template"
      [ : output_param_list
      [ : input_param_list
      [ : register_reserve_list]] ] );
```

<i>instruction_template</i>	Assembly instructions that may contain parameters from the input list or output list in the form: <code>%parm_nr</code>
<code>%parm_nr</code>	Parameter number in the range 0 .. 9.
<i>output_param_list</i>	[[" <code>&</code>] <i>constraint_char</i> "(<i>C_expression</i>)],...]
<i>input_param_list</i>	[[" <i>constraint_char</i> "(<i>C_expression</i>)],...]
<code>&</code>	Says that an output operand is written to before the inputs are read, so this output must not be the same register as any input.
<i>constraint_char</i>	Constraint character: the type of register to be used for the <i>C_expression</i> . See the table below.
<i>C_expression</i>	Any C expression. For output parameters it must be an lvalue, that is, something that is legal to have on the left side of an assignment.
<i>register_reserve_list</i>	[[" <i>register_name</i> "],...]
<i>register_name</i>	Name of the register you want to reserve. For example because this register gets clobbered by the assembly code. The compiler will not use this register for inputs or outputs. Note that reserving too many registers can make register allocation impossible.

Specifying registers for C variables

With a *constraint character* you specify the register type for a parameter.

You can reserve the registers that are used in the assembly instructions, either in the parameter lists or in the reserved register list (*register_reserve_list*). The compiler takes account of these lists, so no unnecessary register saves and restores are placed around the inline assembly instructions.

Constraint character	Type	Operand	Remark
r	general purpose register	r0 .. r11, lr	Thumb mode r0 .. r7
<i>number</i>	type of operand it is associated with	same as <i>%number</i>	Input constraint only. The <i>number</i> must refer to an output parameter. Indicates that <i>%number</i> and <i>number</i> are the same register.

If an input parameter is modified by the inline assembly then this input parameter must also be added to the list of output parameters (see [Example 6](#)). If this is not the case, the resulting code may behave differently than expected since the compiler assumes that an input parameter is not being changed by the inline assembly.

Loops and conditional jumps

The compiler does not detect loops with multiple `__asm()` statements or (conditional) jumps across `__asm()` statements and will generate incorrect code for the registers involved.

If you want to create a loop with `__asm()`, the whole loop must be contained in a single `__asm()` statement. The same counts for (conditional) jumps. As a rule of thumb, all references to a label in an `__asm()` statement must be in that same statement. You can use numeric labels for these purposes.

Example 1: no input or output

A simple example without input or output parameters. You can use any instruction or label. When it is required that a sequence of `__asm()` statements generates a contiguous sequence of instructions, then they can be best combined to a single `__asm()` statement. Compiler optimizations can insert instruction(s) in between `__asm()` statements. Note that you can use standard C escape sequences. Use newline characters `'\n'` to continue on a new line in a `__asm()` statement. For multi-line output, use tab characters `'\t'` to indent instructions.

```
__asm( "nop\n"
      "\tnop" );
```

Example 2: using output parameters

Assign the result of inline assembly to a variable. With the constraint `r` a general purpose register is chosen for the parameter; the compiler decides which register it uses. The `%0` in the instruction template is replaced with the name of this register. The compiler generates code to assign the result to the output variable.

```
int out;
void main( void )
{
```

```
__asm( "mov %0,#0xff"
      : "=r" (out) );
}
```

Generated assembly code:

```
mov r0,#0xff
ldr  r1,.L2
str  r0,[r1,#0]
bx  lr
.size main,$-main
.align 4
.L2:
.dw  out
```

Example 3: using input parameters

Assign a variable to a register. A register is chosen for the parameter because of the constraint `r`; the compiler decides which register is best to use. The `%0` in the instruction template is replaced with the name of this register. The compiler generates code to move the input variable to the input register. Because there are no output parameters, the output parameter list is empty. Only the colon has to be present.

```
int in;
void initreg( void )
{
    __asm( "MOV R0,%0"
          :
          : "r" (in) );
}
```

Generated assembly code:

```
ldr  r0,.L2
ldr  r0,[r0,#0]
MOV  R0,r0
bx  lr
.size initreg,$-initreg
.align 4
.L2:
.dw  in
```

Example 4: using input and output parameters

Add two C variables and assign the result to a third C variable. Registers are used for the input and output parameters (constraint `r`, `%0` for `out`, `%1` for `in1`, `%2` for `in2` in the instruction template). The compiler generates code to move the input expressions into the input registers and to assign the result to the output variable.

```
int in1, in2, out;

void add32( void )
```



```
{
  __asm( "add %0, %1, %2"
        : "=r" (out)
        : "r" (in1), "r" (in2) );
}
```

Generated assembly code:

```
    ldr    r0, .L2
    ldr    r1, [r0, #0]
    ldr    r0, [r0, #4]
    add   r0, r1, r0
    ldr    r1, .L2
    str    r0, [r1, #8]
    bx    lr
    .size  add32, $-add32
    .align 4
.L2:
    .dw    in1

    .section .bss
    .global in1
    .align 4
in1: .type  object
    .size  in1, 4
    .ds    4
    .global in2
    .align 4
in2: .type  object
    .size  in2, 4
    .ds    4
    .global out
    .align 4
out: .type  object
    .size  out, 4
    .ds    4
    .endsec
```

Example 5: reserving registers

Sometimes an instruction knocks out certain specific registers. The most common example of this is a function call, where the called function is allowed to do whatever it likes with some registers. If this is the case, you can list specific registers that get clobbered by an operation after the inputs.

Same as *Example 4*, but now register `r0` is a reserved register. You can do this by adding a reserved register list (`: "r0"`). As you can see in the generated assembly code, register `r0` is not used (the first register used is `r1`).

```
int in1, in2, out;

void add32( void )
```

```
{
  __asm( "add %0, %1, %2"
        : "=r" (out)
        : "r" (in1), "r" (in2)
        : "r0" );
}
```

Generated assembly code:

```
ldr    r2, .L2
ldr    r2, [r1, #0]
ldr    r1, [r1, #4]
add   r1, r2, r1
ldr    r0, .L2
str    r1, [r0, #8]
bx     lr
.size  add32, $-add32
.align 4
.L2:
.dw    in1
```

Example 6: use the same register for input and output

As input constraint you can use a number to refer to an output parameter. This tells the compiler that the same register can be used for the input and output parameter. When the input and output parameter are the same C expression, these will effectively be treated as if the input parameter is also used as output. In that case it is allowed to write to this register. For example:

```
inline int foo(int par1, int par2, int * par3)
{
  int retvalue;

  __asm(
    "add %2,%1,%1,ls1 #2\n\t"
    "mov %5,%2\n\t"
    "mov %0,%2"
    : "=&r" (retvalue), "=r" (par1), "=r" (par2)
    : "1" (par1), "2" (par2), "r" (par3)
    );
  return retvalue;
}

int result, parm;

void func(void)
{
  result = foo(1000, 1000, &parm);
}
```

In this example the "1" constraint for the input parameter `par1` refers to the output parameter `par1`, and similar for the "2" constraint and `par2`. In the inline assembly `%1` (`par1`) and `%2` (`par2`) are written. This is allowed because the compiler is aware of this.

This results in the following generated assembly code:

```

mov  r0,#1000
mov  r1,r0
ldr  r2, .L2

add  r1,r0,r0,ls1 #2
mov  r2,r1
mov  r3,r1

ldr  r0, .L2+4
str  r3,[r0,#0]

bx   lr
.L2:
.dw  parm
.dw  result

```

However, when the inline assembly would have been as given below, the compiler would have assumed that `%1` (`par1`) and `%2` (`par2`) were read-only. Because of the `inline` keyword the compiler knows that `par1` and `par2` both contain 1000. Therefore the compiler can optimize and assign the same register to `%1` and `%2`. This would have given an unexpected result.

```

__asm(
    "add  %2,%1,%1,ls1 #2\n\t"
    "mov  %3,%2\n\t"
    "mov  %0,%2"
    : "=&r" (retvalue)
    : "r" (par1), "r" (par2), "r" (par3)
);

```

Generated assembly code:

```

ldr  r0, .L2
mov  r1,#1000

add  r1,r1,r1,ls1 #2    ; same register, but is expected read-only
mov  r0,r1
mov  r2,r1

ldr  r0, .L2+4
str  r2,[r0,#0]        ; contains unexpected result

bx   lr
.L2:
.dw  parm
.dw  result

```

1.7. Attributes

You can use the keyword `__attribute__` to specify special attributes on declarations of variables, functions, types, and fields.

Syntax:

```
__attribute__((name,...))
```

or:

```
__name__
```

The second syntax allows you to use attributes in header files without being concerned about a possible macro of the same name.

alias("symbol")

You can use `__attribute__((alias("symbol")))` to specify that the function declaration appears in the object file as an alias for another symbol. For example:

```
void __f() { /* function body */; }  
void f() __attribute__((weak, alias("__f")));
```

declares 'f' to be a weak alias for '__f'.

const

You can use `__attribute__((const))` to specify that a function has no side effects and will not access global data. This can help the compiler to optimize code. See also attribute [pure](#).

The following kinds of functions should not be declared `__const__`:

- A function with pointer arguments which examines the data pointed to.
- A function that calls a non-const function.

export

You can use `__attribute__((export))` to specify that a variable/function has external linkage and should not be removed. During MIL linking, the compiler treats external definitions at file scope as if they were declared `static`. As a result, unused variables/functions will be eliminated, and the alias checking algorithm assumes that objects with static storage cannot be referenced from functions outside the current module. During MIL linking not all uses of a variable/function can be known to the compiler. For example when a variable is referenced in an assembly file or a (third-party) library. With the `export` attribute the compiler will not perform optimizations that affect the unknown code.

```
int i __attribute__((export)); /* 'i' has external linkage */
```

flatten

You can use `__attribute__((flatten))` to force inlining of all function calls in a function, including nested function calls.

Unless inlining is impossible or disabled by `__attribute__((noinline))` for one of the calls, the generated code for the function will not contain any function calls.

format(type, arg_string_index, arg_check_start)

You can use `__attribute__((format(type, arg_string_index, arg_check_start)))` to specify that functions take `printf`, `scanf`, `strftime` or `strfmon` style arguments and that calls to these functions must be type-checked against the corresponding format string specification.

type determines how the format string is interpreted, and should be `printf`, `scanf`, `strftime` or `strfmon`.

arg_string_index is a constant integral expression that specifies which argument in the declaration of the user function is the format string argument.

arg_check_start is a constant integral expression that specifies the first argument to check against the format string. If there are no arguments to check against the format string (that is, diagnostics should only be performed on the format string syntax and semantics), *arg_check_start* should have a value of 0. For `strftime`-style formats, *arg_check_start* must be 0.

Example:

```
int foo(int i, const char * my_format, ...) __attribute__((format(printf, 2, 3)));
```

The format string is the second argument of the function `foo` and the arguments to check start with the third argument.

leaf

You can use `__attribute__((leaf))` to specify that a function is a leaf function. A leaf function is an external function that does not call a function in the current compilation unit, directly or indirectly. The attribute is intended for library functions to improve dataflow analysis. The attribute has no effect on functions defined within the current compilation unit.

malloc

You can use `__attribute__((malloc))` to improve optimization and error checking by telling the compiler that:

- The return value of a call to such a function points to a memory location or can be a null pointer.
- On return of such a call (before the return value is assigned to another variable in the caller), the memory location mentioned above can be referenced only through the function return value; e.g., if the pointer value is saved into another global variable in the call, the function is not qualified for the `malloc` attribute.

- The lifetime of the memory location returned by such a function is defined as the period of program execution between a) the point at which the call returns and b) the point at which the memory pointer is passed to the corresponding deallocation function. Within the lifetime of the memory object, no other calls to malloc routines should return the address of the same object or any address pointing into that object.

noinline

You can use `__attribute__((noinline))` to prevent a function from being considered for inlining. Same as keyword `__noinline` or `#pragma noinline`.

always_inline

With `__attribute__((always_inline))` you force the compiler to inline the specified function, regardless of the optimization strategy of the compiler itself. Same as keyword `inline` or `#pragma inline`.

noreturn

Some standard C function, such as `abort` and `exit` cannot return. The C compiler knows this automatically. You can use `__attribute__((noreturn))` to tell the compiler that a function never returns. For example:

```
void fatal() __attribute__((noreturn));

void fatal( /* ... */ )
{
    /* Print error message */
    exit(1);
}
```

The function `fatal` cannot return. The compiler can optimize without regard to what would happen if `fatal` ever did return. This can produce slightly better code and it helps to avoid warnings of uninitialized variables.

protect

You can use `__attribute__((protect))` to exclude a variable/function from the duplicate/unreferenced section removal optimization in the linker. When you use this attribute, the compiler will add the "protect" section attribute to the symbol's section. Example:

```
int i __attribute__((protect));
```

Note that the `protect` attribute will not prevent the compiler from removing an unused variable/function (see the `used symbol attribute`).

This attribute is the same as `#pragma protect/endprotect`.

pure

You can use `__attribute__((pure))` to specify that a function has no side effects, although it may read global data. Such pure functions can be subject to common subexpression elimination and loop optimization. See also attribute `const`.

section("section_name")

You can use `__attribute__((section("name")))` to specify that a function must appear in the object file in a particular section. For example:

```
extern void foobar(void) __attribute__((section("bar")));
```

puts the function `foobar` in the section named `bar`.

See also `#pragma section`.

used

You can use `__attribute__((used))` to prevent an unused symbol from being removed, by both the compiler and the linker. Example:

```
static const char copyright[] __attribute__((used)) = "Copyright 2010 Altium BV";
```

When there is no C code referring to the `copyright` variable, the compiler will normally remove it. The `__attribute__((used))` symbol attribute prevents this. Because the linker should also not remove this symbol, `__attribute__((used))` implies `__attribute__((protect))`.

unused

You can use `__attribute__((unused))` to specify that a variable or function is possibly unused. The compiler will not issue warning messages about unused variables or functions.

weak

You can use `__attribute__((weak))` to specify that the symbol resulting from the function declaration or variable must appear in the object file as a weak symbol, rather than a global one. This is primarily useful when you are writing library functions which can be overwritten in user code without causing duplicate name errors.

See also `#pragma weak`.

1.8. Pragmas to Control the Compiler

Pragmas are keywords in the C source that control the behavior of the compiler. Pragmas overrule compiler options. Put pragmas in your C source where you want them to take effect. Unless stated

TASKING VX-toolset for ARM User Guide

otherwise, a pragma is in effect from the point where it is included to the end of the compilation unit or until another pragma changes its status.

The syntax is:

```
#pragma [label:]pragma-spec pragma-arguments [on | off | default | restore]
```

or:

```
_Pragma( "[label:]pragma-spec pragma-arguments [on | off | default | restore]" )
```

Some pragmas can accept the following special arguments:

on	switch the flag on (same as without argument)
off	switch the flag off
default	set the pragma to the initial value
restore	restore the previous value of the pragma

Label pragmas

Some pragmas support a label prefix of the form "*label*:" between `#pragma` and the pragma name. Such a label prefix limits the effect of the pragma to the statement following a label with the specified name. The `restore` argument on a pragma with a label prefix has a special meaning: it removes the most recent definition of the pragma for that label.

You can see a label pragma as a kind of macro mechanism that inserts a pragma in front of the statement after the label, and that adds a corresponding `#pragma ... restore` after the statement.

Compared to regular pragmas, label pragmas offer the following advantages:

- The pragma text does not clutter the code, it can be defined anywhere before a function, or even in a header file. So, the pragma setting and the source code are uncoupled. When you use different header files, you can experiment with a different set of pragmas without altering the source code.
- The pragma has an implicit end: the end of the statement (can be a loop) or block. So, no need for `pragma restore / endoptimize` etc.

Example:

```
#pragma lab1:optimize P

volatile int v;

void f( void )
{
    int i, a;

    a = 42;

lab1: for( i=1; i<10; i++ )
```



```

    {
        /* the entire for loop is part of the pragma optimize */
        a += i;
    }
    v = a;
}

```

Supported pragmas

The compiler recognizes the following pragmas, other pragmas are ignored. Pragmas marked with (*) support a label prefix.

alias *symbol*=*defined_symbol*

Define *symbol* as an alias for *defined_symbol*. It corresponds to a `.ALIAS` directive at assembly level. The *symbol* should not be defined elsewhere, and *defined_symbol* should be defined with static storage duration (not extern or automatic).

call {near | far | default | restore} (*)

By default, functions are called with 26-bit PC-relative calls. This *near* call is directly coded into the instruction, resulting in higher execution speed and smaller code size. The destination address of a near call must be located within +/-32 MB from the program counter.

The other call mode is a 32-bit indirect call. With *far* calls you can address the full range of memory. The address is first loaded into a register after which the call is executed.

See C compiler option `--call (-m)`.

compactmaxmatch {value | default | restore} (*)

With this pragma you can control the maximum size of a match.

See C compiler option `--compact-max-size`.

extension isuffix [on | off | default | restore] (*)

Enables a language extension to specify imaginary floating-point constants. With this extension, you can use an "i" suffix on a floating-point constant, to make the type `_Imaginary`.

```
float 0.5i
```

extern *symbol*

Normally, when you use the C keyword `extern`, the compiler generates an `.EXTERN` directive in the generated assembly source. However, if the compiler does not find any references to the `extern` symbol in the C module, it optimizes the assembly source by leaving the `.EXTERN` directive out.

With this pragma you can force an external reference (`.EXTERN` assembler directive), even when the *symbol* is not used in the module.

fp_negzero [on | off | default | restore] (*)

With this pragma you can control the **+negzero** flag of C compiler option **--fp-model**.

fp_rewrite [on | off | default | restore] (*)

With this pragma you can control the **+rewrite** flag of C compiler option **--fp-model**.

inline / noinline / smartinline

See Section 1.11.2, *Inlining Functions: inline*.

inline_max_incr / inline_max_size {value | default | restore} (*)

With these pragmas you can control the automatic function inlining optimization process of the compiler. It has only effect when you have enabled the inlining optimization (**--optimize=+inline (-Oi)**).

See C compiler options **--inline-max-incr** and **--inline-max-size**.

macro / nomacro [on | off | default | restore] (*)

Turns macro expansion on or off. By default, macro expansion is enabled.

maxcalldepth {value | default | restore} (*)

With this pragma you can control the maximum call depth. Default is infinite (-1).

See C compiler option **--max-call-depth**.

message "message" ...

Print the message string(s) on standard output.

nomisrac [nr,...] [default | restore] (*)

Without arguments, this pragma disables MISRA C checking. Alternatively, you can specify a comma-separated list of MISRA C rules to disable.

See C compiler option **--misrac** and Section 4.6.2, *C Code Checking: MISRA C*.

optimize [flags | default | restore] (*) / endoptimize

You can overrule the C compiler option **--optimize** for the code between the pragmas `optimize` and `endoptimize`. The pragma works the same as C compiler option **--optimize**.

See Section 4.5, *Compiler Optimizations*.

profile [*flags* | default | restore] (*) / endprofile

Control the profile settings. The pragma works the same as C compiler option `--profile`. Note that this pragma will only be checked at the start of a function. `endprofile` switches back to the previous profiling settings.

profiling [on | off | default | restore] (*)

If profiling is enabled on the command line (C compiler option `--profile`), you can disable part of your source code for profiling with the pragmas `profiling off` and `profiling`.

protect [on | off | default | restore] (*) / endprotect

With these pragmas you can protect sections against linker optimizations. This excludes a section from unreferenced section removal and duplicate section removal by the linker. `endprotect` restores the default section protection.

runtime [*flags* | default | restore] (*)

With this pragma you can control the generation of additional code to check for a number of errors at run-time. The pragma argument syntax is the same as for the arguments of the C compiler option `--runtime`. You can use this pragma to control the run-time checks for individual statements. In addition, objects declared when the "bounds" sub-option is disabled are not bounds checked. The "malloc" sub-option cannot be controlled at statement level, as it only extracts an alternative malloc implementation from the library.

section [*name*={*suffix* |-f|-m|-fm} [default | restore] (*) / endsection

Rename sections by adding a *suffix* to all section names specified with *name*, or restore default section naming. If you specify only a *suffix* (without a name), the suffix is added to all section names. See C compiler option `--rename-sections` and assembler directive `.SECTION` for more information.

section_code_init [on | off | default | restore] (*) / section_no_code_init

Copy or do not copy code sections from ROM to RAM at application startup.

section_const_init [on | off | default | restore] (*) / section_no_const_init

Copy or do not copy read-only data sections from ROM to RAM at application startup.

silicon_bug [*bug*,...] [default | restore] (*)

Without arguments, all silicon bug workarounds are enabled. Alternatively, you can specify a comma-separated list of silicon bug workarounds.

See C compiler option `--silicon-bug` and Chapter 19, *CPU Problem Bypasses and Checks*.

source [on | off | default | restore] (*) / nosource

With these pragmas you can choose which C source lines must be listed as comments in assembly output.

See C compiler option `--source`.

stdinc [on | off | default | restore] (*)

This pragma changes the behavior of the `#include` directive. When set, the C compiler options `--include-directory` and `--no-stdinc` are ignored.

linear_switch / jump_switch / binary_switch / smart_switch / tbb_switch / tbb_switch / no_tbb_switch

With these pragmas you can overrule the compiler chosen switch method:

<code>linear_switch</code>	Force jump chain code. A jump chain is comparable with an if/else-if/else-if/else construction.
<code>jump_switch</code>	Force jump table code. A jump table is a table filled with jump instructions for each possible switch value. The switch argument is used as an index to jump within this table.
<code>binary_switch</code>	Force binary lookup table code. A binary search table is a table filled with a value to compare the switch argument with and a target address to jump to.
<code>smart_switch</code>	Let the compiler decide the switch method used.
<code>tbb_switch</code>	Force use of the <code>tbb</code> instruction. Uses a table of 8-bit jump offsets.
<code>tbb_switch</code>	Force use of the <code>tbb</code> instruction. Uses a table of 8-bit jump offsets.
<code>no_tbb_switch</code>	Same as <code>smart_switch</code> , but do not use the <code>tbb</code> instruction.

See Section 1.10, *Switch Statement*.

tradeoff {/level | default | restore} (*)

Specify tradeoff between speed (0) and size (4). See C compiler option `--tradeoff`

warning [number,...] [default | restore] (*)

With this pragma you can disable warning messages. If you do not specify a warning number, all warnings will be suppressed.

weak symbol

Mark a symbol as "weak" (`.WEAK` assembler directive). The symbol must have external linkage, which means a global or external object or function. A static symbol cannot be declared weak.

A weak external reference is resolved by the linker when a global (or weak) definition is found in one of the object files. However, a weak reference will not cause the extraction of a module from a library to resolve the reference. When a weak external reference cannot be resolved, the null pointer is substituted.

A weak definition can be overruled by a normal global definition. The linker will not complain about the duplicate definition, and ignore the weak definition.

1.9. Predefined Preprocessor Macros

The TASKING C compiler supports the predefined macros as defined in the table below. The macros are useful to create conditional C code.

Macro	Description
<code>__ARM__</code>	Expands to 1 for the ARM toolset, otherwise unrecognized as macro.
<code>__BIG_ENDIAN__</code>	Expands to 1 if big-endian mode is selected (option <code>--endianness=big</code>), otherwise unrecognized as macro.
<code>__BUILD__</code>	Identifies the build number of the compiler, composed of decimal digits for the build number, three digits for the major branch number and three digits for the minor branch number. For example, if you use build 1.22.1 of the compiler, <code>__BUILD__</code> expands to 1022001. If there is no branch number, the branch digits expand to zero. For example, build 127 results in 127000000.
<code>__CARM__</code>	Expands to 1 for the ARM toolset, otherwise unrecognized as macro.
<code>__CPU__</code>	Expands to the ARM architecture name (option <code>--cpu=arch</code>). When no <code>--cpu</code> is supplied, this symbol is not defined. For example, if <code>--cpu=ARMv7M</code> is specified, the symbol <code>__CPU__</code> expands to <code>ARMv7M</code> .
<code>__CPU_arch__</code>	A symbol is defined depending on the option <code>--cpu=arch</code> . The <i>arch</i> is converted to uppercase. For example, if <code>--cpu=ARMv7M</code> is specified, the symbol <code>__CPU_ARMV7M__</code> is defined. When no <code>--cpu</code> is supplied, this symbol <code>__CPU_ARMV7M__</code> is the default.
<code>__DATE__</code>	Expands to the compilation date: "mmm dd yyyy".
<code>__DOUBLE_FP__</code>	Expands to 1 if you used option <code>--fp-model=float</code> , otherwise unrecognized as macro.
<code>__DSPC__</code>	Indicates conformation to the DSP-C standard. It expands to 1.
<code>__DSPC_VERSION__</code>	Expands to the decimal constant 200001L.
<code>__FILE__</code>	Expands to the current source file name.
<code>__FPU_fpu__</code>	A symbol is defined depending on the option <code>--fpu=fpu</code> . The <i>fpu</i> is converted to uppercase and the lowercase "v" and the '-' will be removed. For example, if <code>--fpu=VFPv3-sp</code> is specified, the symbol <code>__FPU_VFP3SP__</code> is defined. When no <code>--fpu</code> is supplied, the symbol <code>__FPU_NONE__</code> is the default.
<code>__FPU_VFP__</code>	Expands to 1 if one the options <code>--fpu=fpu</code> is specified and <i>fpu</i> is not NONE.
<code>__LINE__</code>	Expands to the line number of the line where this macro is called.
<code>__LITTLE_ENDIAN__</code>	Expands to 1 if little-endian mode is selected (option <code>--endianness=little</code>), otherwise unrecognized as macro. This is the default.
<code>__MISRAC_VERSION__</code>	Expands to the MISRA C version used 1998, 2004 or 2012 (option <code>--misrac-version</code>). The default is 2004.

Macro	Description
<code>__PROF_ENABLE__</code>	Expands to 1 if profiling is enabled, otherwise expands to 0.
<code>__REVISION__</code>	Expands to the revision number of the compiler. Digits are represented as they are; characters (for prototypes, alphas, betas) are represented by -1. Examples: v1.0r1 -> 1, v1.0rb -> -1
<code>__SINGLE_FP__</code>	Expands to 1 if you used option <code>--fp-model=+float</code> (Treat 'double' as 'float'), otherwise unrecognized as macro.
<code>__STDC__</code>	Identifies the level of ANSI standard. The macro expands to 1 if you set option <code>--language</code> (Control language extensions), otherwise expands to 0.
<code>__STDC_HOSTED__</code>	Always expands to 0, indicating the implementation is not a hosted implementation.
<code>__STDC_VERSION__</code>	Identifies the ISO-C version number. Expands to 199901L for ISO C99 or 199409L for ISO C90.
<code>__TASKING__</code>	Identifies the compiler as a TASKING compiler. Expands to 1 if a TASKING compiler is used.
<code>__THUMB__</code>	Expands to 1 if you used option <code>--thumb</code> , otherwise unrecognized as macro.
<code>__TIME__</code>	Expands to the compilation time: "hh:mm:ss"
<code>__VERSION__</code>	Identifies the version number of the compiler. For example, if you use version 3.0r1 of the compiler, <code>__VERSION__</code> expands to 3000 (dot and revision number are omitted, minor version number in 3 digits).

Example

```
#ifdef __CARM__
/* this part is only compiled for the ARM */
...
#endif
```

1.10. Switch Statement

The TASKING C compiler supports three ways of code generation for a switch statement: a jump chain (linear switch), a jump table or a binary search table.

A *jump chain* is comparable with an if/else-if/else-if/else construction. A *jump table* is a table filled with jump instructions for each possible switch value. The switch argument is used as an index to jump within this table. A *binary search table* is a table filled with a value to compare the switch argument with and a target address to jump to.

`#pragma smart_switch` is the default of the compiler. The compiler will automatically choose the most efficient switch implementation based on code and data size and execution speed. With the C compiler option `--tradeoff` you can tell the compiler to put more emphasis on speed than on memory size.

For a switch with a long type argument, only linear code is used.

For an int type argument, a jump table switch is only used when the table of cases is not too sparse.

Especially for large switch statements, the jump table approach executes faster than the binary search table approach. Also the jump table has a predictable behavior in execution speed: independent of the switch argument, every case is reached in the same execution time. However, when the case labels are distributed far apart, the jump table becomes sparse, wasting code memory. The compiler will not use the jump table method when the waste becomes excessive.

With a small number of cases, the jump chain method can be faster in execution and shorter in size.

For ARMv7M a switch using the `tbb` instruction gets priority over a normal switch table implementation.

How to overrule the default switch method

You can overrule the compiler chosen switch method by using a pragma:

```
#pragma linear_switch    force jump chain code
#pragma jump_switch      force jump table code
#pragma binary_switch    force binary search table code
#pragma smart_switch     let the compiler decide the switch method used
#pragma tbb_switch       force use of tbb instruction (uses a table of 8-bit jump offsets)
#pragma tbh_switch       force use of tbh instruction (uses a table of 16-bit jump offsets)
#pragma no_tbh_switch    same as smart_switch, but do not use tbh instruction
```

Using a pragma cannot overrule the restrictions as described earlier.

The switch pragmas must be placed before the `switch` statement. Nested `switch` statements use the same switch method, unless the nested `switch` is implemented in a separate function which is preceded by a different switch pragma.

Example:

```
/* place pragma before function body */

#pragma jump_switch

void test(unsigned char val)
{ /* function containing the switch */
    switch (val)
    {
        /* use jump table */
    }
}
```

1.11. Functions

1.11.1. Calling Convention

Parameter passing

A lot of execution time of an application is spent transferring parameters between functions. The fastest parameter transport is via registers. Therefore, function parameters are first passed via registers. If no more registers are available for a parameter, the compiler pushes parameters on the stack.

Registers available for parameter passing are r0, r1, r2 and r3.

Parameter type	Registers used for parameters
_Bool, char, short, int, long, float, 32-bit pointer, 32-bit struct	R0, R1, R2, R3
long long, double, 64-bit struct	R0R1, R1R2, R2R3

The parameters are processed from left to right. The first not used and fitting register is used. Registers are searched for in the order listed above. When a parameter is > 64 bit, or all registers are used, parameter passing continues on the stack. The stack grows from higher towards lower addresses. The first parameter is pushed at the lowest stack address. The alignment on the stack depends on the data type as listed in [Section 1.1, Data Types](#).

Examples:

```
void func1( int a, char * b, char c );      /* R0 R1 R2 */
void func2( long long d, char e );        /* R0R1 R2 */
void func4( double f, long long g, char h );
                                           /* R0R1 R2R3 stack */
```

Function return values

The C compiler uses registers to store C function return values, depending on the function return types.

Return type	Register
_Bool, char, short, int, long, float, 32-bit pointer, 32-bit struct	R0
long long, double, 64-bit struct	R0R1

Objects larger than 64 bits are returned via the stack.

1.11.2. Inlining Functions: inline

With the C compiler option `--optimize+=inline`, the C compiler automatically inlines small functions in order to reduce execution time (smart inlining). The compiler inserts the function body at the place the function is called. The C compiler decides which functions will be inlined. You can overrule this behavior with the two keywords `inline` (ISO-C) and `__noinline`.

With the `inline` keyword you force the compiler to inline the specified function, regardless of the optimization strategy of the compiler itself:

```
inline unsigned int abs(int val)
{
    unsigned int abs_val = val;
    if (val < 0) abs_val = -val;
    return abs_val;
}
```

If a function with the keyword `inline` is not called at all, the compiler does not generate code for it.

You must define inline functions in the same source module as in which you call the function, because the compiler only inlines a function in the module that contains the function definition. When you need to call the inline function from several source modules, you must include the definition of the inline function in each module (for example using a header file).

With the `__noinline` keyword, you prevent a function from being inlined:

```
__noinline unsigned int abs(int val)
{
    unsigned int abs_val = val;
    if (val < 0) abs_val = -val;
    return abs_val;
}
```

Using pragmas: inline, noinline, smartinline

Instead of the `inline` qualifier, you can also use `#pragma inline` and `#pragma noinline` to inline a function body:

```
#pragma inline
unsigned int abs(int val)
{
    unsigned int abs_val = val;
    if (val < 0) abs_val = -val;
    return abs_val;
}
#pragma noinline
void main( void )
{
    int i;
    i = abs(-1);
}
```

If a function has an `inline`/`__noinline` function qualifier, then this qualifier will overrule the current pragma setting.

With the `#pragma noinline`/`#pragma smartinline` you can temporarily disable the default behavior that the C compiler automatically inlines small functions when you turn on the [C compiler option `--optimize+=inline`](#).

With the C compiler options `--inline-max-incr` and `--inline-max-size` you have more control over the automatic function inlining process of the compiler.

Combining inline with `__asm` to create intrinsic functions

With the keyword `__asm` it is possible to use assembly instructions in the body of an inline function. Because the compiler inserts the (assembly) body at the place the function is called, you can create your own intrinsic function. See [Section 1.11.4.2, Writing Your Own Intrinsic Function](#).

1.11.3. Interrupt Functions / Exception Handlers

The TASKING C compiler supports a number of function qualifiers and keywords to program exception handlers. An *exception handler* (or: interrupt function) is called when an exception occurs.

The ARM supports seven types of exceptions. The next table lists the types of exceptions and the processor mode that is used to process that exception. When an exception occurs, execution is forced from a fixed memory address corresponding to the type of exception. These fixed addresses are called the exception vectors.

Exception type	Mode	Normal address	High vector address	Function type qualifier
Reset	Supervisor	0x00000000	0xFFFF0000	
Undefined instructions	Undefined	0x00000004	0xFFFF0004	<code>__interrupt_und</code>
Supervisor call (software interrupt)	Supervisor	0x00000008	0xFFFF0008	<code>__interrupt_svc</code>
Prefetch abort	Abort	0x0000000C	0xFFFF000C	<code>__interrupt_iabt</code>
Data abort	Abort	0x00000010	0xFFFF0010	<code>__interrupt_dabt</code>
IRQ (interrupt)	IRQ	0x00000018	0xFFFF0018	<code>__interrupt_irq</code>
FIQ (fast interrupt)	FIQ	0x0000001C	0xFFFF001C	<code>__interrupt_fiq</code>

ARMv6-M and ARMv7-M (M-profile architectures) have a different exception model. Read the *ARM Architecture Reference Manual* for details.

1.11.3.1. Defining an Exception Handler: `__interrupt` Keywords

You can define six types of exception handlers with the function type qualifiers `__interrupt_und`, `__interrupt_svc`, `__interrupt_iabt`, `__interrupt_dabt`, `__interrupt_irq` and `__interrupt_fiq`. You can also use the general `__interrupt()` function qualifier.

Interrupt functions and other exception handlers cannot return anything and must have a **void** argument type list:

```
void __interrupt_xxx
isr( void )
{
```

```

...
}

void __interrupt(n)
isr2( void )
{
...
}

```

Example

```

void __interrupt_irq serial_receive( void )
{
...
}

```

Vector symbols

When you use one or more of these `__interrupt_XXX` function qualifiers, the compiler generates a corresponding vector symbol to designate the start of an exception handler function. The linker uses this symbol to automatically generate the exception vector.

Function type qualifier	Vector symbol	Vector symbol M-profile
<code>__interrupt_und</code>	<code>_vector_1</code>	-
<code>__interrupt_svc</code>	<code>_vector_2</code>	<code>_vector_11</code>
<code>__interrupt_iabt</code>	<code>_vector_3</code>	-
<code>__interrupt_dabt</code>	<code>_vector_4</code>	-
<code>__interrupt_irq</code>	<code>_vector_6</code>	-
<code>__interrupt_fiq</code>	<code>_vector_7</code>	-
<code>__interrupt(<i>n</i>)</code>	<code>_vector_<i>n</i></code>	<code>_vector_<i>n</i></code>

Note that the reset handler is designated by the symbol `_START` instead of `_vector_0` (`_vector_1` for M-profile architectures).

You can prevent the compiler from generating the `_vector_n` symbol by specifying the function qualifier `__novector`. This can be necessary if you have more than one interrupt handler for the same exception, for example for different IRQ's or for different run-time phases of your application. Without the `__novector` function qualifier the compiler generates the `_vector_n` symbol multiple times, which results in a link error.

```

void __interrupt_irq __novector another_handler( void )
{
... // used __novector to prevent multiple _vector_6 symbols
}

```

Enable interrupts in exception handlers (not for M-profile architectures)

Normally interrupts are disabled when an exception handler is entered. With the function qualifier `__nesting_enabled` you can force that the link register (LR) is saved and that interrupts are enabled. For example:

```
void __interrupt_svc __nesting_enabled svc( int n )
{
    if ( n == 2 )
    {
        __svc(3);
    }
    ...
}
```

1.11.3.2. Interrupt Frame: `__frame()`

With the function type qualifier `__frame()` you can specify which registers and SFRs must be saved for a particular interrupt function. Only the specified registers will be pushed and popped from the stack. If you do not specify the function qualifier `__frame()`, the C compiler determines which registers must be pushed and popped. The syntax is:

```
void __interrupt_xxx
    __frame(reg[, reg]...) isr( void )
{
    ...
}
```

where, *reg* can be any register defined as an SFR. The compiler generates a warning if some registers are missing which are normally required to be pushed and popped in an interrupt function prolog and epilg to avoid run-time problems.

Example

```
__interrupt_irq __frame(R4,R5,R6) void alarm( void )
{
    ...
}
```

1.11.4. Intrinsic Functions

Some specific assembly instructions have no equivalence in C. *Intrinsic functions* give the possibility to use these instructions. Intrinsic functions are predefined functions that are recognized by the compiler. The compiler generates the most efficient assembly code for these functions.

The compiler always inlines the corresponding assembly instructions in the assembly source (rather than calling it as a function). This avoids parameter passing and register saving instructions which are normally necessary during function calls.

Intrinsic functions produce very efficient assembly code. Though it is possible to inline assembly code by hand, intrinsic functions use registers even more efficiently. At the same time your C source remains very readable.

You can use intrinsic functions in C as if they were ordinary C (library) functions. All intrinsics begin with a double underscore character (`__`).

On the command line you can see a list of intrinsic functions with the following command:

```
carm --help=intrinsics
```

The TASKING ARM C compiler recognizes the following intrinsic functions:

`__alloc`

```
void * volatile __alloc( __size_t size );
```

Allocate memory. Returns a pointer to space of `size` bytes on the stack of the calling function. Memory allocated through this function is freed when the calling function returns. This function is used internally for variable length arrays, it is not to be used by end users.

`__free`

```
void volatile __free( void * p );
```

Deallocate the memory pointed to by `p`. `p` must point to memory earlier allocated by a call to `__alloc()`.

`__nop`

```
void __nop( void );
```

Generate a NOP instruction.

`__get_return_address`

```
__codeptr volatile __get_return_address( void );
```

Used by the compiler for profiling when you compile with the option `--profile`. Returns the return address of a function.

`__remap_pc`

```
void volatile __remap_pc( void );
```

Load the 'real' program address. This intrinsic is used in the startup code to assure that the reset handler is immune for any ROM/RAM remapping.

`__setsp`

```
void volatile __setsp( __data void * stack );
```

Initialize the stack pointer with 'stack'.

__getspsr

```
unsigned int volatile __getspsr( void );
```

Get the value of the SPSR status register. Returns the value of the status register SPSR.

__setspsr

```
unsigned int volatile __setspsr( int set, int clear);
```

Set or clear bits in the SPSR status register. Returns the new value of the SPSR status register.

Example:

```
#define SR_F 0x00000040
#define SR_I 0x00000080

i = __setspsr (0, SR_F | SR_I);

    if (i & (SR_F | SR_I))
    {
        exit (6);    /* Interrupt flags not correct */
    }

    if (__getspsr () & (SR_F | SR_I))
    {
        exit (7);    /* Interrupt flags not correct */
    }
```

__getcpsr

```
unsigned int volatile __getcpsr( void );
```

Get the value of the CPSR status register. Returns the value of the status register CPSR.

__setcpsr

```
unsigned int volatile __setcpsr( int set, int clear);
```

Set or clear bits in the CPSR status register. Returns the new value of the CPSR status register.

__getapsr

```
unsigned int volatile __getapsr( void );
```

Get the value of the APSR status register (ARMv6-M and ARMv7-M). Returns the value of the status register APSR.

__setapsr

```
unsigned int volatile __setapsr( int set, int clear);
```

Set or clear bits in the APSR status register (ARMv6-M and ARMv7-M). Returns the new value of the APSR status register.

`__getipsr`

```
unsigned int volatile __getipsr( void );
```

Get the value of the IPSR status register (ARMv6-M and ARMv7-M). Returns the value of the status register IPSR.

`__svc`

```
void volatile __svc(int number);
```

Generate a supervisor call (software interrupt). Number must be a constant value.

1.11.4.1. CMSIS Intrinsic

The TASKING VX-toolset for ARM supports the Cortex Micro-controller Software Interface Standard (CMSIS). You can find details about this standard on www.arm.com.

The required functions as defined in the CMSIS are supported by the compiler as intrinsic functions and do not have any implementation in the CMSIS-CORE files. The implemented intrinsic functions are:

CMSIS core register access

`__enable_irq`

```
void volatile __enable_irq( void );
```

Global Interrupt enable (using the instruction CPSIE i).

`__disable_irq`

```
void volatile __disable_irq( void );
```

Global Interrupt disable (using the instruction CPSID i).

`__set_PRIMASK`

```
void volatile __set_PRIMASK( unsigned int value );
```

Assign value to Priority Mask Register (using the instruction MSR).

`__get_PRIMASK`

```
unsigned int __get_PRIMASK( void );
```

Return Priority Mask Register (using the instruction MRS).

TASKING VX-toolset for ARM User Guide

__enable_fault_irq

```
void volatile __enable_fault_irq( void );
```

Global Fault exception and Interrupt enable (using the instruction CPSIE f).

__disable_fault_irq

```
void volatile __disable_fault_irq( void );
```

Global Fault exception and Interrupt disable (using the instruction CPSID f).

__set_FAULTMASK

```
void volatile __set_FAULTMASK( unsigned int value );
```

Assign value to Fault Mask Register (using the instruction MSR).

__get_FAULTMASK

```
unsigned int __get_FAULTMASK( void );
```

Return Fault Mask Register (using the instruction MRS).

__set_BASEPRI

```
void volatile __set_BASEPRI( unsigned int value );
```

Set Base Priority (using the instruction MSR).

__get_BASEPRI

```
unsigned int __get_BASEPRI( void );
```

Return Base Priority (using the instruction MRS).

__set_CONTROL

```
void volatile __set_CONTROL( unsigned int value );
```

Set CONTROL register value (using the instruction MSR).

__get_CONTROL

```
unsigned int __get_CONTROL( void );
```

Return Control Register Value (using the instruction MRS).

__set_PSP

```
void volatile __set_PSP( unsigned int value );
```

Set Process Stack Pointer value (using the instruction MSR).

__get_PSP

```
unsigned int __get_PSP( void );
```

Return Process Stack Pointer (using the instruction MRS).

__set_MSP

```
void volatile __set_MSP( unsigned int value );
```

Set Main Stack Pointer (using the instruction MSR).

__get_MSP

```
unsigned int __get_MSP( void );
```

Return Main Stack Pointer (using the instruction MRS).

CMSIS core instruction access**__NOP**

```
void volatile __NOP( void );
```

No Operation. This instruction does nothing. You can use this instruction for code alignment purposes.

__WFI

```
void volatile __WFI( void );
```

Wait for Interrupt. Suspends execution until one of a number of events occurs.

__WFE

```
void volatile __WFE( void );
```

Wait for Event. Permits the processor to enter a low-power state until one of a number of events occurs.

__SEV

```
void volatile __SEV( void );
```

Set Event. Causes an event to be signaled to the CPU.

__ISB

```
void volatile __ISB( void );
```

Instruction Synchronization Barrier. Flushes the pipeline in the processor, so that all instructions following the ISB are fetched from cache or memory, after the instruction has been completed.

__DSB

```
void volatile __DSB( void );
```

Data Synchronization Barrier. This function acts as a special kind of Data Memory Barrier. It completes when all explicit memory accesses before this instruction have been completed.

__DMB

```
void volatile __DMB( void );
```

Data Memory Barrier. This function ensures the apparent order of the explicit memory operations before and after the instruction, without ensuring their completion.

__REV

```
unsigned int __REV( unsigned int value );
```

Reverse byte order in integer value.

__REV16

```
unsigned int __REV16( unsigned short value );
```

Reverse byte order in unsigned short value.

__REVSH

```
signed int __REVSH( signed int value );
```

Reverse byte order in signed short value with sign extension to integer.

__RBIT

```
unsigned int __RBIT( unsigned int value );
```

Reverse bit order of value.

__ROR

```
unsigned int __ROR( unsigned int op, unsigned int shift );
```

Rotate Right in unsigned value (32 bit). This function Rotate Right (immediate) provides the value of the contents of a register rotated by a variable number of bits.

__LDREXB

```
unsigned volatile char __LDREXB( unsigned char * addr );
```

Load exclusive byte. This function performs an exclusive LDR command for 8-bit values.

__LDREXH

```
unsigned volatile short __LDREXH( unsigned short * addr );
```

Load exclusive half-word. This function performs an exclusive LDR command for 16-bit values.

__LDREXW

```
unsigned int volatile __LDREXW( unsigned int * addr );
```

Load exclusive word. This function performs an exclusive LDR command for 32-bit values.

__STREXB

```
unsigned int volatile __STREXB( unsigned char value, unsigned char * addr );
```

Store exclusive byte. This function performs an exclusive STR command for 8-bit values.

__STREXH

```
unsigned int volatile __STREXH( unsigned short value, unsigned short * addr );
```

Store exclusive half-word. This function performs an exclusive STR command for 16-bit values.

__STREXW

```
unsigned int volatile __STREXW( unsigned int value, unsigned int * addr );
```

Store exclusive word. This function performs an exclusive STR command for 32-bit values.

__CLREX

```
void volatile __CLREX( void );
```

Remove the exclusive lock created by `__LDREXB`, `__LDREXH`, or `__LDREXW`.

__RRX

```
unsigned int volatile __RRX( unsigned int value );
```

Rotate Right with Extend (32-bit). This function moves each bit of a bit string right by one bit. The carry input is shifted in at the left end of the bit string.

__LDRBT

```
unsigned char volatile __LDRBT( unsigned char *addr );
```

LDRT Unprivileged (8-bit). This function performs an Unprivileged LDRT command for 8-bit values.

__LDRHT

```
unsigned volatile short __LDRHT( unsigned short *addr );
```

TASKING VX-toolset for ARM User Guide

LDRT Unprivileged (16-bit). This function performs an Unprivileged LDRT command for 16-bit values.

__LDRT

```
unsigned char volatile __LDRT( unsigned int *addr );
```

LDRT Unprivileged (32-bit). This function performs an Unprivileged LDRT command for 32-bit values.

__STRBT

```
void volatile __STRBT( unsigned char value, unsigned char *addr );
```

STRT Unprivileged (8-bit). This function performs an Unprivileged STRT command for 8-bit values.

__STRHT

```
void volatile __STRHT( unsigned short value, unsigned short *addr );
```

STRT Unprivileged (16-bit). This function performs an Unprivileged STRT command for 16-bit values.

__STRT

```
void volatile __STRT( unsigned int value, unsigned int *addr );
```

STRT Unprivileged (32-bit). This function performs an Unprivileged STRT command for 32-bit values.

__BKPT

```
void volatile __BKPT( unsigned short int );
```

Set Breakpoint. This function causes the processor to enter Debug state. Debug tools can use this to investigate system state when the instruction at a particular address is reached.

__CLZ

```
unsigned char __CLZ( unsigned int value );
```

Count leading zeros. This function counts the number of leading zeros of a data value.

__SSAT

```
int __SSAT( int value, unsigned int sat );
```

Signed Saturate. This function saturates a signed value.

__USAT

```
unsigned int __USAT( unsigned int value, unsigned int sat );
```

Unsigned Saturate. This function saturates an unsigned value.

1.11.4.2. Writing Your Own Intrinsic Function

Because you can use any assembly instruction with the `__asm()` keyword, you can use the `__asm()` keyword to create your own intrinsic functions. The essence of an intrinsic function is that it is inlined.

1. First write a function with assembly in the body using the keyword `__asm()`. See [Section 1.6, Using Assembly in the C Source: `__asm\(\)`](#)
2. Next make sure that the function is inlined rather than being called. You can do this with the function qualifier `inline`. This qualifier is discussed in more detail in [Section 1.11.2, Inlining Functions: `inline`](#).

```
inline int __my_pow( int base, int power )
{
    int result;

    __asm( "movs  %0,#1\n"
          "1:\n\t"
          "subs  %2,%2,#1\n\t"
          "mul   %0,%0,%1\n\t"
          "bne   1p\n\t"
          : "=r"(result)
          : "r"(base), "r"(power) );

    return result;
}

int main(void)
{
    int result;

    // call to function __my_pow
    result = __my_pow(3,2);

    return result;
}
```

Generated assembly code (compiled for ARMv7M):

```
main:    .type func
        ; __my_pow code is inlined here
        mov     r1,#2
        mov     r2,#3

        movs   r0,#1
1:      subs   r1,r1,#1
        mul   r0,r0,r2
        bne   1p
```

As you can see, the generated assembly code for the function `__my_pow` is inlined rather than called. Numeric labels are used for the loop.

Chapter 2. C++ Language

The TASKING C++ compiler (**cparm**) offers a new approach to high-level language programming for your ARM architecture. The C++ compiler accepts the C++ language as defined by the ISO/IEC 14882:2003 standard. It also accepts the language extensions of the C compiler (see [Chapter 1, C Language](#)).

This chapter describes the C++ language implementation and some specific features.

Note that the C++ language itself is not described in this document. For more information on the C++ language, see

- The C++ Programming Language (second edition) by Bjarne Strastrup (1991, Addison Wesley)
- ISO/IEC 14882:1998 C++ standard [ANSI]
- ISO/IEC 14882:2003 C++ standard [ISO/IEC]
- ISO/IEC 14882:2011 C++ standard [ISO/IEC]
- ISO/IEC 14882:2014 C++ standard [ISO/IEC]

More information on the standards can be found at <http://www.iso.org/>

2.1. C++ Language Extension Keywords

The C++ compiler supports the same language extension keywords as the C compiler. When [option `--strict`](#) is used, the extensions will be disabled.

pragmas

The C++ compiler supports the pragmas as explained in [Section 2.7, *Pragmas to Control the C++ Compiler*](#). Pragmas give directions to the code generator of the compiler.

2.2. C++ Dialect Accepted

The C++ compiler accepts the complete C++ language as defined by the ISO/IEC 14882:2003 standard.

With [option `--c++11`](#) the C++ compiler accepts the complete C++11 language as defined by the ISO/IEC 14882:2011 standard.

With [option `--c++14`](#) the C++ compiler accepts the complete C++14 language as defined by the ISO/IEC 14882:2014 standard.

Command line options are also available to enable and disable anachronisms and strict standard-conformance checking.

2.2.1. Default C++ Mode

The following extensions are accepted in default C++ mode. Most of these are also accepted in any other C++ mode (except when strict ANSI/ISO violations are diagnosed as errors or were explicitly noted):

- A `friend` declaration for a class may omit the `class` keyword:

```
class A {
    friend B; // Should be "friend class B"
};
```

- Constants of scalar type may be defined within classes:

```
class A {
    const int size = 10;
    int a[size];
};
```

- In the declaration of a class member, a qualified name may be used:

```
struct A {
    int A::f(); // Should be int f();
};
```

- The `restrict` keyword is allowed.
- A `const` qualified object with file scope or namespace scope and the `__at()` attribute will have external linkage, unless explicitly declared `static`. Examples:

```
const int i = 5; // internal linkage
const int j __at( 0x1234 ) = 10; // external linkage
static const int k __at( 0x1236 ) = 15; // internal linkage
```

Note that no warning is generated when 'j' is not used.

- Implicit type conversion between a pointer to an extern "C" function and a pointer to an extern "C++" function is permitted. Here's an example:

```
extern "C" void f(); // f's type has extern "C" linkage
void (*pf)() // pf points to an extern "C++" function
    = &f; // error unless implicit conversion is
          // allowed
```

This extension is allowed in environments where C and C++ functions share the same calling conventions. It is enabled by default.

- A "?" operator whose second and third operands are string literals or wide string literals can be implicitly converted to `"char *"` or `"wchar_t *"`. (Recall that in C++ string literals are `const`. There is a deprecated implicit conversion that allows conversion of a string literal to `"char *"`, dropping the `const`.)

That conversion, however, applies only to simple string literals. Allowing it for the result of a "?" operation is an extension.)

```
char *p = x ? "abc" : "def";
```

- Default arguments may be specified for function parameters other than those of a top-level function declaration (e.g., they are accepted on `typedef` declarations and on pointer-to-function and pointer-to-member-function declarations).
- Non-static local variables of an enclosing function can be referenced in a non-evaluated expression (e.g., a `sizeof` expression) inside a local class. A warning is issued.
- In default C++ mode, the friend class syntax is extended to allow nonclass types as well as class types expressed through a `typedef` or without an elaborated type name. For example:

```
typedef struct S ST;
class C {
    friend S;           // OK (requires S to be in scope).
    friend ST;         // OK (same as "friend S;").
    friend int;        // OK (no effect).
    friend S const;    // Error: cv-qualifiers cannot
                       // appear directly.
};
```

- In default C++ mode, mixed string literal concatenations are accepted. (This is a feature carried over from C99 and also available in GNU modes).

```
wchar_t *str = "a" L"b"; // OK, same as L"ab".
```

- In default C++ mode, variadic macros are accepted. (This is a feature carried over from C99 and also available in GNU modes.)
- In default C++ mode, empty macro arguments are accepted (a feature carried over from C99).
- A trailing comma in the definition of an enumeration type is silently accepted (a feature carried over from C99):

```
enum E { e, };
```

2.2.2. GNU C++ Mode

The C++ compiler can be configured to support GNU C++ (command line option `--g++`). In GNU C++ mode, many extensions provided by the GNU C++ compiler are accepted.

Because the GNU C++ compiler frequently changes behavior between releases, the C++ compiler provides an option (`--gnu_version`) to specify a specific version of GCC to emulate. Generally speaking, features and bugs are emulated to exactly match each known version of GCC, but occasionally the emulation is approximate and in such cases the C++ compiler is often a little more permissive than GCC on the principle that it is more important to accept source that GCC accepts than to diagnose every case that GCC

diagnoses. The C++ compiler does not, however, attempt to emulate every GCC command line option; in particular, GCC options to be extra-permissive are not emulated (however, the severity of specific error diagnostics can sometimes be decreased to accept constructs that are not by-default allowed in GNU emulation mode).

The following GNU extensions are *not* supported:

- The forward declaration of function parameters (so they can participate in variable-length array parameters).
- GNU-style complex integral types (complex floating-point types are supported)
- Nested functions
- Local structs with variable-length array fields.

2.2.3. Anachronisms Accepted

The following anachronisms are accepted when anachronisms are enabled (with `--anachronisms`):

- `overload` is allowed in function declarations. It is accepted and ignored.
- Definitions are not required for static data members that can be initialized using default initialization. The anachronism does not apply to static data members of template classes; they must always be defined.
- The number of elements in an array may be specified in an array `delete` operation. The value is ignored.
- A single `operator++()` and `operator--()` function can be used to overload both prefix and postfix operations.
- The base class name may be omitted in a base class initializer if there is only one immediate base class.
- Assignment to `this` in constructors and destructors is allowed. This is allowed only if anachronisms are enabled and the "assignment to `this`" configuration parameter is enabled.
- A bound function pointer (a pointer to a member function for a given object) can be cast to a pointer to a function.
- A nested class name may be used as a non-nested class name provided no other class of that name has been declared. The anachronism is not applied to template classes.
- A reference to a non-const type may be initialized from a value of a different type. A temporary is created, it is initialized from the (converted) initial value, and the reference is set to the temporary.
- A reference to a non-const class type may be initialized from an rvalue of the class type or a derived class thereof. No (additional) temporary is used.
- A function with old-style parameter declarations is allowed and may participate in function overloading as though it were prototyped. Default argument promotion is not applied to parameter types of such

functions when the check for compatibility is done, so that the following declares the overloading of two functions named `f`:

```
int f(int);
int f(x) char x; { return x; }
```

Note that in C this code is legal but has a different meaning: a tentative declaration of `f` is followed by its definition.

- When option `--nonconst-ref-anachronism` is set, a reference to a non-const class can be bound to a class rvalue of the same type or a derived type thereof.

```
struct A {
    A(int);
    A operator=(A&);
    A operator+(const A&);
};
main () {
    A b(1);
    b = A(1) + A(2); // Allowed as anachronism
}
```

2.3. Namespace Support

Namespaces are enabled by default. You can use the [command line option `--no-namespaces`](#) to disable the features.

When doing name lookup in a template instantiation, some names must be found in the context of the template definition while others may also be found in the context of the template instantiation. The C++ compiler implements two different instantiation lookup algorithms: the one mandated by the standard (referred to as "dependent name lookup"), and the one that existed before dependent name lookup was implemented.

Dependent name lookup is done in strict mode (unless explicitly disabled by another command line option) or when dependent name processing is enabled by either a configuration flag or command line option.

Dependent Name Processing

When doing dependent name lookup, the C++ compiler implements the instantiation name lookup rules specified in the standard. This processing requires that non-class prototype instantiations be done. This in turn requires that the code be written using the `typename` and `template` keywords as required by the standard.

Lookup Using the Referencing Context

When not using dependent name lookup, the C++ compiler uses a name lookup algorithm that approximates the two-phase lookup rule of the standard, but does so in such a way that is more compatible with existing code and existing compilers.

When a name is looked up as part of a template instantiation but is not found in the local context of the instantiation, it is looked up in a synthesized instantiation context that includes both names from the context of the template definition and names from the context of the instantiation. Here's an example:

```
namespace N {
    int g(int);
    int x = 0;
    template <class T> struct A {
        T f(T t) { return g(t); }
        T f() { return x; }
    };
}

namespace M {
    int x = 99;
    double g(double);
    N::A<int> ai;
    int i = ai.f(0); // N::A<int>::f(int) calls
                   // N::g(int)
    int i2 = ai.f(); // N::A<int>::f() returns
                   // 0 (= N::x)

    N::A<double> ad;
    double d = ad.f(0); // N::A<double>::f(double)
                       // calls M::g(double)
    double d2 = ad.f(); // N::A<double>::f() also
                       // returns 0 (= N::x)
}
```

The lookup of names in template instantiations does not conform to the rules in the standard in the following respects:

- Although only names from the template definition context are considered for names that are not functions, the lookup is not limited to those names visible at the point at which the template was defined.
- Functions from the context in which the template was referenced are considered for all function calls in the template. Functions from the referencing context should only be visible for "dependent" function calls.

Argument Dependent Lookup

When argument-dependent lookup is enabled (this is the default), functions made visible using argument-dependent lookup overload with those made visible by normal lookup. The standard requires that this overloading occurs even when the name found by normal lookup is a block `extern` declaration. The C++ compiler does this overloading, but in default mode, argument-dependent lookup is suppressed when the normal lookup finds a block `extern`.

This means a program can have different behavior, depending on whether it is compiled with or without argument-dependent lookup `--no-arg-dep-lookup`, even if the program makes no use of namespaces. For example:

```

struct A { };
A operator+(A, double);
void f() {
    A a1;
    A operator+(A, int);
    a1 + 1.0; // calls operator+(A, double)
             // with arg-dependent lookup enabled but
             // otherwise calls operator+(A, int);
}

```

2.4. Template Instantiation

The C++ language includes the concept of *templates*. A template is a description of a class or function that is a model for a family of related classes or functions.¹ For example, one can write a template for a `Stack` class, and then use a stack of integers, a stack of floats, and a stack of some user-defined type. In the source, these might be written `Stack<int>`, `Stack<float>`, and `Stack<X>`. From a single source description of the template for a stack, the compiler can create *instantiations* of the template for each of the types required.

The instantiation of a class template is always done as soon as it is needed in a compilation. However, the instantiations of template functions, member functions of template classes, and static data members of template classes (hereafter referred to as template entities) are not necessarily done immediately, for several reasons:

- One would like to end up with only one copy of each instantiated entity across all the object files that make up a program. (This of course applies to entities with external linkage.)
- The language allows one to write a *specialization* of a template entity, i.e., a specific version to be used in place of a version generated from the template for a specific data type. (One could, for example, write a version of `Stack<int>`, or of just `Stack<int>::push`, that replaces the template-generated version; often, such a specialization provides a more efficient representation for a particular data type.) Since the compiler cannot know, when compiling a reference to a template entity, if a specialization for that entity will be provided in another compilation, it cannot do the instantiation automatically in any source file that references it.
- The language also dictates that template functions that are not referenced should not be compiled, that, in fact, such functions might contain semantic errors that would prevent them from being compiled. Therefore, a reference to a template class should not automatically instantiate all the member functions of that class.

(It should be noted that certain template entities are always instantiated when used, e.g., inline functions.)

From these requirements, one can see that if the compiler is responsible for doing all the instantiations automatically, it can only do so on a program-wide basis. That is, the compiler cannot make decisions about instantiation of template entities until it has seen all the source files that make up a complete program.

¹Since templates are descriptions of entities (typically, classes) that are parameterizable according to the types they operate upon, they are sometimes called *parameterized types*.

This C++ compiler provides an instantiation mechanism that does automatic instantiation at link time. For cases where you want more explicit control over instantiation, the C++ compiler also provides instantiation modes and instantiation pragmas, which can be used to exert fine-grained control over the instantiation process.

2.4.1. Instantiation Modes

Normally, when a file is compiled, template entities are instantiated everywhere where they are used. The overall instantiation mode can, however, be changed by a command line option:

--instantiate=used

Instantiate those template entities that were used in the compilation. This will include all static data members for which there are template definitions. This is the default.

--instantiate=all

Instantiate all template entities declared or referenced in the compilation unit. For each fully instantiated template class, all of its member functions and static data members will be instantiated whether or not they were used. Non-member template functions will be instantiated even if the only reference was a declaration.

--instantiate=local

Similar to **--instantiate=used** except that the functions are given internal linkage. This is intended to provide a very simple mechanism for those getting started with templates. The compiler will instantiate the functions that are used in each compilation unit as local functions, and the program will link and run correctly (barring problems due to multiple copies of local static variables.) However, one may end up with many copies of the instantiated functions, so this is not suitable for production use. **--instantiate=local** cannot be used in conjunction with automatic template instantiation. If automatic instantiation is enabled by default, it will be disabled by the **--instantiate=local** option.

In the case where the **ccarm** command is given a single file to compile and link, e.g.,

```
ccarm test.cc
```

the compiler knows that all instantiations will have to be done in the single source file. Therefore, it uses the **--instantiate=used** mode and suppresses automatic instantiation.

2.4.2. Instantiation #pragma Directives

Instantiation pragmas can be used to control the instantiation of specific template entities or sets of template entities. There are three instantiation pragmas:

- The **instantiate** pragma causes a specified entity to be instantiated.
- The **do_not_instantiate** pragma suppresses the instantiation of a specified entity. It is typically used to suppress the instantiation of an entity for which a specific definition will be supplied.
- The **can_instantiate** pragma indicates that a specified entity can be instantiated in the current compilation, but need not be; it is used in conjunction with automatic instantiation, to indicate potential sites for instantiation if the template entity turns out to be required.

The argument to the instantiation pragma may be:

- a template class name `A<int>`
- a template class declaration `class A<int>`
- a member function name `A<int>::f`
- a static data member name `A<int>::i`
- a static data declaration `int A<int>::i`
- a member function declaration `void A<int>::f(int, char)`
- a template function declaration `char* f(int, float)`

A pragma in which the argument is a template class name (e.g., `A<int>` or `class A<int>`) is equivalent to repeating the pragma for each member function and static data member declared in the class. When instantiating an entire class a given member function or static data member may be excluded using the **do_not_instantiate** pragma. For example,

```
#pragma instantiate A<int>
#pragma do_not_instantiate A<int>::f
```

The template definition of a template entity must be present in the compilation for an instantiation to occur. If an instantiation is explicitly requested by use of the **instantiate** pragma and no template definition is available or a specific definition is provided, an error is issued.

```
template <class T> void f1(T); // No body provided
template <class T> void g1(T); // No body provided

void f1(int) {} // Specific definition
void main()
{
    int i;
    double d;
    f1(i);
    f1(d);
    g1(i);
    g1(d);
}

#pragma instantiate void f1(int) // error - specific
                                // definition
#pragma instantiate void g1(int) // error - no body
                                // provided
```

`f1(double)` and `g1(double)` will not be instantiated (because no bodies were supplied) but no errors will be produced during the compilation (if no bodies are supplied at link time, a linker error will be produced).

TASKING VX-toolset for ARM User Guide

A member function name (e.g., `A<int>::f`) can only be used as a pragma argument if it refers to a single user defined member function (i.e., not an overloaded function). Compiler-generated functions are not considered, so a name may refer to a user defined constructor even if a compiler-generated copy constructor of the same name exists. Overloaded member functions can be instantiated by providing the complete member function declaration, as in

```
#pragma instantiate char* A<int>::f(int, char*)
```

The argument to an instantiation pragma may not be a compiler-generated function, an inline function, or a pure virtual function.

2.4.3. Implicit Inclusion

When implicit inclusion is enabled, the C++ compiler is given permission to assume that if it needs a definition to instantiate a template entity declared in a `.h` file it can implicitly include the corresponding `.cc` file to get the source code for the definition. For example, if a template entity `ABC::f` is declared in file `xyz.h`, and an instantiation of `ABC::f` is required in a compilation but no definition of `ABC::f` appears in the source code processed by the compilation, the compiler will look to see if a file `xyz.cc` exists, and if so it will process it as if it were included at the end of the main source file.

To find the template definition file for a given template entity the C++ compiler needs to know the path name specified in the original include of the file in which the template was declared and whether the file was included using the system include syntax (e.g., `#include <file.h>`). This information is not available for preprocessed source containing `#line` directives. Consequently, the C++ compiler will not attempt implicit inclusion for source code containing `#line` directives.

The file to be implicitly included is found by replacing the file suffix with each of the suffixes specified in the instantiation file suffix list. The normal include search path mechanism is then used to look for the file to be implicitly included.

By default, the list of definition file suffixes tried is `.c`, `.cc`, `.cpp`, and `.cxx`.

Implicit inclusion works well alongside automatic instantiation, but the two are independent. They can be enabled or disabled independently, and implicit inclusion is still useful when automatic instantiation is not done.

The implicit inclusion mode can be turned on by the [command line option `--implicit-include`](#).

Implicit inclusions are only performed during the normal compilation of a file, (i.e., not when doing only preprocessing). A common means of investigating certain kinds of problems is to produce a preprocessed source file that can be inspected. When using implicit inclusion it is sometimes desirable for the preprocessed source file to include any implicitly included files. This may be done using the [command line option `--no-preprocessing-only`](#). This causes the preprocessed output to be generated as part of a normal compilation. When implicit inclusion is being used, the implicitly included files will appear as part of the preprocessed output in the precise location at which they were included in the compilation.

2.5. Inlining Functions

The C++ compiler supports a minimal form of function inlining. When the C++ compiler encounters a call of a function declared `inline` it can replace the call with the body of the function with the parameters

replaced by the corresponding arguments. When a function call occurs as a statement, the statements of the function body are inserted in place of the call. When the function call occurs within an expression, the body of the function is rewritten as one large expression and that expression is inserted in the proper place in the containing expression. It is not always possible to do this sort of inlining: there are certain constructs (e.g. loops and inline assembly) that cannot be rendered in expression form. Even when inlining is done at the statement level, there are certain constructs that are not practical to inline. Calls that cannot be inlined are left in their original call form, and an out-of-line copy of the function is used. When enabled, a remark is issued.

When the C++ compiler decides not to inline a function, the keyword `inline` is passed to the generated C file. This allows for the C compiler to decide again whether to inline a function or not.

A function is disqualified for inlining immediately if any of the following are true:

- The function has local static variables.
- The function has local constants.
- The function has local types.
- The function has block scopes.
- The function includes pragmas.
- The function has a variable argument list.

2.6. Extern Inline Functions

Depending on the way in which the C++ compiler is configured, out-of-line copies of `extern inline` functions are either implemented using static functions, or are instantiated using a mechanism like the template instantiation mechanism. Note that out-of-line copies of inline functions are only required in cases where the function cannot be inlined, or when the address of the function is taken (whether explicitly by the user, by implicitly generated functions, or by compiler-generated data structures such as virtual function tables or exception handling tables).

When static functions are used, local static variables of the functions are promoted to global variables with specially encoded names, so that even though there may be multiple copies of the code, there is only one copy of such global variables. This mechanism does not strictly conform to the standard because the address of an extern inline function is not constant across translation units.

When the instantiation mechanism is used, the address of an extern inline function is constant across translation units, but at the cost of requiring the use of one of the template instantiation mechanisms, even for programs that don't use templates. Definitions of extern inline functions can be provided either through use of the automatic instantiation mechanism or by use of the `--instantiate=used` or `--instantiate=all` instantiation modes. There is no mechanism to manually control the definition of extern inline function bodies.

2.7. Pragas to Control the C++ Compiler

Pragas are keywords in the C++ source that control the behavior of the compiler. Pragas overrule compiler options.

The syntax is:

```
#pragma pragma-spec
```

The C++ compiler supports the following pragmas:

instantiate / do_not_instantiate / can_instantiate

These are template instantiation pragmas. They are described in detail in [Section 2.4.2, *Instantiation #pragma Directives*](#).

hdrstop / no_pch

These are precompiled header pragmas. They are described in detail in [Section 2.9, *Precompiled Headers*](#).

once

When placed at the beginning of a header file, indicates that the file is written in such a way that including it several times has the same effect as including it once. Thus, if the C++ compiler sees `#pragma once` at the start of a header file, it will skip over it if the file is `#included` again.

A typical idiom is to place an `#ifndef` guard around the body of the file, with a `#define` of the guard variable after the `#ifndef`:

```
#pragma once    // optional
#ifndef FILE_H
#define FILE_H
... body of the header file ...
#endif
```

The `#pragma once` is marked as optional in this example, because the C++ compiler recognizes the `#ifndef` idiom and does the optimization even in its absence. `#pragma once` is accepted for compatibility with other compilers and to allow the programmer to use other guard-code idioms.

2.8. Predefined Macros

The C++ compiler defines a number of preprocessing macros. Many of them are only defined under certain circumstances. This section describes the macros that are provided and the circumstances under which they are defined.

Macro	Description
<code>__ABI_COMPATIBILITY_VERSION</code>	Defines the ABI compatibility version being used. This macro is set to 9999, which means the latest version. This macro is used when building the C++ library.
<code>__ABI_CHANGES_FOR_RTTI</code>	This macro is set to <code>TRUE</code> , meaning that the ABI changes for RTTI are implemented. This macro is used when building the C++ library.
<code>__ABI_CHANGES_FOR_ARRAY_NEW_AND_DELETE</code>	This macro is set to <code>TRUE</code> , meaning that the ABI changes for array <code>new</code> and <code>delete</code> are implemented. This macro is used when building the C++ library.
<code>__ABI_CHANGES_FOR_PLACEMENT_DELETE</code>	This macro is set to <code>TRUE</code> , meaning that the ABI changes for placement <code>delete</code> are implemented. This macro is used when building the C++ library.
<code>__ARRAY_OPERATORS</code>	Defined when array <code>new</code> and <code>delete</code> are enabled. This is the default.
<code>__BASE_FILE__</code>	Similar to <code>__FILE__</code> but indicates the primary source file rather than the current one (i.e., when the current file is an included file).
<code>__BIG_ENDIAN__</code>	Expands to 1 if big-endian mode is selected (option <code>--endianness=big</code>), otherwise unrecognized as macro.
<code>_BOOL</code>	Defined when <code>bool</code> is a keyword. This is the default.
<code>__BUILD__</code>	Identifies the build number of the C++ compiler, composed of decimal digits for the build number, three digits for the major branch number and three digits for the minor branch number. For example, if you use build 1.22.1 of the compiler, <code>__BUILD__</code> expands to 1022001. If there is no branch number, the branch digits expand to zero. For example, build 127 results in 127000000.
<code>__CHAR_MIN / __CHAR_MAX</code>	Used in <code>limits.h</code> to define the minimum/maximum value of a plain <code>char</code> respectively.
<code>__CHAR16_T_AND_CHAR32_T</code>	Defined when <code>char16_t</code> and <code>char32_t</code> are keywords. These keywords are enabled when you use C++ compiler option <code>--uliterals</code> .
<code>__CHAR16_TYPE__</code>	Defined as the underlying type for <code>char16_t</code> (GNU version 40400 and above, see <code>--gnu-version</code>).

Macro	Description
__CHAR32_TYPE__	Defined as the underlying type for <code>char32_t</code> (GNU version 40400 and above, see --gnu-version).
__CPARM__	Identifies the C++ compiler. You can use this symbol to flag parts of the source which must be recognized by the <code>cparm</code> C++ compiler only. It expands to 1.
__cplusplus	Always defined.
__CPU__	Expands to a string with the CPU supplied with the option --cpu . When no <code>--cpu</code> is supplied, this symbol is not defined.
__DATE__	Defined to the date of the compilation in the form "Mmm dd yyyy".
__DELTA_TYPE	Defines the type of the offset field in the virtual function table. This macro is used when building the C++ library.
__DOUBLE_FP__	Expands to 1 if you did <i>not</i> use option --no-double (Treat 'double' as 'float'), otherwise unrecognized as macro.
__embedded_cplusplus	Defined as 1 in Embedded C++ mode.
__EXCEPTIONS	Defined when exception handling is enabled (--exceptions).
__FILE__	Expands to the current source file name.
__FUNCTION__	Defined to the name of the current function. An error is issued if it is used outside of a function.
__func__	Same as <code>__FUNCTION__</code> in GNU mode.
__IMPLICIT_USING_STD	Defined when the standard header files should implicitly do a using-directive on the <code>std</code> namespace (--using-std).
__JMP_BUF_ELEMENT_TYPE	Specifies the type of an element of the <code>setjmp</code> buffer. This macro is used when building the C++ library.
__JMP_BUF_NUM_ELEMENTS	Defines the number of elements in the <code>setjmp</code> buffer. This macro is used when building the C++ library.
__LINE__	Expands to the line number of the line where this macro is called.
__LITTLE_ENDIAN__	Expands to 1 if little-endian mode is selected (option --endianness=little), otherwise unrecognized as macro. This is the default.

Macro	Description
<code>__NAMESPACES</code>	Defined when namespaces are supported (this is the default, you can disable support for namespaces with <code>--no-namespaces</code>).
<code>__NO_LONG_LONG</code>	Defined when the <code>long long</code> type is not supported. This is the default.
<code>__NULL_EH_REGION_NUMBER</code>	Defines the value used as the null region number value in the exception handling tables. This macro is used when building the C++ library.
<code>__PLACEMENT_DELETE</code>	Defined when placement delete is enabled.
<code>__PRETTY_FUNCTION__</code>	Defined to the name of the current function. This includes the return type and parameter types of the function. An error is issued if it is used outside of a function.
<code>__PTRDIFF_MIN / __PTRDIFF_MAX</code>	Used in <code>stdint.h</code> to define the minimum/maximum value of a <code>ptrdiff_t</code> type respectively.
<code>__PTRDIFF_TYPE__</code>	Defined to be the type of <code>ptrdiff_t</code> .
<code>__REGION_NUMBER_TYPE</code>	Defines the type of a region number field in the exception handling tables. This macro is used when building the C++ library.
<code>__REVISION__</code>	Expands to the revision number of the C++ compiler. Digits are represented as they are; characters (for prototypes, alphas, betas) are represented by <code>-1</code> . Examples: <code>v1.0r1 -> 1</code> , <code>v1.0rb -> -1</code>
<code>__RTTI</code>	Defined when RTTI is enabled (<code>--rtti</code>).
<code>__RUNTIME_USES_NAMESPACES</code>	Defined when the run-time uses namespaces.
<code>__SIGNED_CHARS__</code>	Defined when plain <code>char</code> is signed.
<code>__SINGLE_FP__</code>	Expands to 1 if you used option <code>--no-double</code> (Treat 'double' as 'float'), otherwise unrecognized as macro.
<code>__SIZE_MIN / __SIZE_MAX</code>	Used in <code>stdint.h</code> to define the minimum/maximum value of a <code>size_t</code> type respectively.
<code>__SIZE_TYPE__</code>	Defined to be the type of <code>size_t</code> .
<code>__STDC__</code>	Always defined, but the value may be redefined.
<code>__STDC_VERSION__</code>	Identifies the ISO-C version number. Expands to 199901L for ISO C99, but the value may be redefined.

Macro	Description
<code>_STLP_NO_IOSTREAMS</code>	Defined when option <code>--io-streams</code> is not used. This disables I/O stream functions in the STLport C++ library.
<code>__TASKING__</code>	Always defined for the TASKING C++ compiler.
<code>__THUMB__</code>	Expands to 1 if you used option <code>--thumb</code> , otherwise unrecognized as macro.
<code>__TIME__</code>	Expands to the compilation time: "hh:mm:ss"
<code>__TYPE_TRAITS_ENABLED</code>	Defined when type traits pseudo-functions (to ease the implementation of ISO/IEC TR 19768; e.g., <code>__is_union</code>) are enabled. This is the default in C++ mode.
<code>__VAR_HANDLE_TYPE</code>	Defines the type of the variable-handle field in the exception handling tables. This macro is used when building the C++ library.
<code>__VARIADIC_TEMPLATES</code>	Defined when C++11 variadic templates are supported (option <code>--variadic-templates</code>).
<code>__VERSION__</code>	Identifies the version number of the C++ compiler. For example, if you use version 2.1r1 of the compiler, <code>__VERSION__</code> expands to 2001 (dot and revision number are omitted, minor version number in 3 digits).
<code>__VIRTUAL_FUNCTION_INDEX_TYPE</code>	Defines the type of the virtual function index field of the virtual function table. This macro is used when building the C++ library.
<code>__WCHAR_MIN / __WCHAR_MAX</code>	Used in <code>stdint.h</code> to define the minimum/maximum value of a <code>wchar_t</code> type respectively.
<code>_WCHAR_T</code>	Defined when <code>wchar_t</code> is a keyword.

2.9. Precompiled Headers

It is often desirable to avoid recompiling a set of header files, especially when they introduce many lines of code and the primary source files that `#include` them are relatively small. The C++ compiler provides a mechanism for, in effect, taking a snapshot of the state of the compilation at a particular point and writing it to a disk file before completing the compilation; then, when recompiling the same source file or compiling another file with the same set of header files, it can recognize the "snapshot point", verify that the corresponding precompiled header (PCH) file is reusable, and read it back in. Under the right circumstances, this can produce a dramatic improvement in compilation time; the trade-off is that PCH files can take a lot of disk space.

2.9.1. Automatic Precompiled Header Processing

When `--pch` appears on the command line, automatic precompiled header processing is enabled. This means the C++ compiler will automatically look for a qualifying precompiled header file to read in and/or will create one for use on a subsequent compilation.

The PCH file will contain a snapshot of all the code preceding the "header stop" point. The header stop point is typically the first token in the primary source file that does not belong to a preprocessing directive, but it can also be specified directly by `#pragma hdrstop` (see below) if that comes first. For example:

```
#include "xxx.h"
#include "yyy.h"
int i;
```

The header stop point is `int` (the first non-preprocessor token) and the PCH file will contain a snapshot reflecting the inclusion of `xxx.h` and `yyy.h`. If the first non-preprocessor token or the `#pragma hdrstop` appears within a `#if` block, the header stop point is the outermost enclosing `#if`. To illustrate, here's a more complicated example:

```
#include "xxx.h"
#ifdef YY_H
#define YY_H 1
#include "yyy.h"
#endif
#if TEST
int i;
#endif
```

Here, the first token that does not belong to a preprocessing directive is again `int`, but the header stop point is the start of the `#if` block containing it. The PCH file will reflect the inclusion of `xxx.h` and conditionally the definition of `YY_H` and inclusion of `yyy.h`; it will not contain the state produced by `#if TEST`.

A PCH file will be produced only if the header stop point and the code preceding it (mainly, the header files themselves) meet certain requirements:

- The header stop point must appear at file scope -- it may not be within an unclosed scope established by a header file. For example, a PCH file will not be created in this case:

```
// xxx.h
class A {

// xxx.C
#include "xxx.h"
int i; };
```

- The header stop point may not be inside a declaration started within a header file, nor (in C++) may it be part of a declaration list of a linkage specification. For example, in the following case the header stop point is `int`, but since it is not the start of a new declaration, no PCH file will be created:

TASKING VX-toolset for ARM User Guide

```
// yyy.h
static

// yyy.C
#include "yyy.h"
int i;
```

- Similarly, the header stop point may not be inside a `#if` block or a `#define` started within a header file.
- The processing preceding the header stop must not have produced any errors. (Note: warnings and other diagnostics will not be reproduced when the PCH file is reused.)
- No references to predefined macros `__DATE__` or `__TIME__` may have appeared.
- No use of the `#line` preprocessing directive may have appeared.
- **#pragma no_pch** (see below) must not have appeared.
- The code preceding the header stop point must have introduced a sufficient number of declarations to justify the overhead associated with precompiled headers. The minimum number of declarations required is 1.

When the host system does not support memory mapping, so that everything to be saved in the precompiled header file is assigned to preallocated memory (MS-Windows), two additional restrictions apply:

- The total memory needed at the header stop point cannot exceed the size of the block of preallocated memory.
- No single program entity saved can exceed 16384, the preallocation unit.

When a precompiled header file is produced, it contains, in addition to the snapshot of the compiler state, some information that can be checked to determine under what circumstances it can be reused. This includes:

- The compiler version, including the date and time the compiler was built.
- The current directory (i.e., the directory in which the compilation is occurring).
- The command line options.
- The initial sequence of preprocessing directives from the primary source file, including `#include` directives.
- The date and time of the header files specified in `#include` directives.

This information comprises the PCH prefix. The prefix information of a given source file can be compared to the prefix information of a PCH file to determine whether the latter is applicable to the current compilation.

As an illustration, consider two source files:

```
// a.cc
#include "xxx.h"
...           // Start of code
// b.cc
#include "xxx.h"
...           // Start of code
```

When `a.cc` is compiled with `--pch`, a precompiled header file named `a.pch` is created. Then, when `b.cc` is compiled (or when `a.cc` is recompiled), the prefix section of `a.pch` is read in for comparison with the current source file. If the command line options are identical, if `xxx.h` has not been modified, and so forth, then, instead of opening `xxx.h` and processing it line by line, the C++ compiler reads in the rest of `a.pch` and thereby establishes the state for the rest of the compilation.

It may be that more than one PCH file is applicable to a given compilation. If so, the largest (i.e., the one representing the most preprocessing directives from the primary source file) is used. For instance, consider a primary source file that begins with

```
#include "xxx.h"
#include "yyy.h"
#include "zzz.h"
```

If there is one PCH file for `xxx.h` and a second for `xxx.h` and `yyy.h`, the latter will be selected (assuming both are applicable to the current compilation). Moreover, after the PCH file for the first two headers is read in and the third is compiled, a new PCH file for all three headers may be created.

When a precompiled header file is created, it takes the name of the primary source file, with the suffix replaced by an implementation-specified suffix (`pch` by default). Unless `--pch-dir` is specified (see below), it is created in the directory of the primary source file.

When a precompiled header file is created or used, a message such as

```
"test.cc": creating precompiled header file "test.pch"
```

is issued. The user may suppress the message by using the [command line option `--no-pch-messages`](#).

When the [option `--pch-verbose`](#) is used the C++ compiler will display a message for each precompiled header file that is considered that cannot be used giving the reason that it cannot be used.

In automatic mode (i.e., when `--pch` is used) the C++ compiler will deem a precompiled header file obsolete and delete it under the following circumstances:

- if the precompiled header file is based on at least one out-of-date header file but is otherwise applicable for the current compilation; or
- if the precompiled header file has the same base name as the source file being compiled (e.g., `xxx.pch` and `xxx.cc`) but is not applicable for the current compilation (e.g., because of different command line options).

This handles some common cases; other PCH file clean-up must be dealt with by other means (e.g., by the user).

Support for precompiled header processing is not available when multiple source files are specified in a single compilation: an error will be issued and the compilation aborted if the command line includes a request for precompiled header processing and specifies more than one primary source file.

2.9.2. Manual Precompiled Header Processing

Command line option `--create-pch=file-name` specifies that a precompiled header file of the specified name should be created.

Command line option `--use-pch=file-name` specifies that the indicated precompiled header file should be used for this compilation; if it is invalid (i.e., if its prefix does not match the prefix for the current primary source file), a warning will be issued and the PCH file will not be used.

When either of these options is used in conjunction with `--pch-dir`, the indicated file name (which may be a path name) is tacked on to the directory name, unless the file name is an absolute path name.

The options `--create-pch`, `--use-pch`, and `--pch` may not be used together. If more than one of these options is specified, only the last one will apply. Nevertheless, most of the description of automatic PCH processing applies to one or the other of these modes -- header stop points are determined the same way, PCH file applicability is determined the same way, and so forth.

2.9.3. Other Ways to Control Precompiled Headers

There are several ways in which the user can control and/or tune how precompiled headers are created and used.

- **#pragma hdrstop** may be inserted in the primary source file at a point prior to the first token that does not belong to a preprocessing directive. It enables you to specify where the set of header files subject to precompilation ends. For example,

```
#include "xxx.h"
#include "yyy.h"
#pragma hdrstop
#include "zzz.h"
```

Here, the precompiled header file will include processing state for `xxx.h` and `yyy.h` but not `zzz.h`. (This is useful if the user decides that the information added by what follows the **#pragma hdrstop** does not justify the creation of another PCH file.)

- **#pragma no_pch** may be used to suppress precompiled header processing for a given source file.
- Command line option `--pch-dir=directory-name` is used to specify the directory in which to search for and/or create a PCH file.

Moreover, when the host system does not support memory mapping and preallocated memory is used instead, then one of the command line options `--pch`, `--create-pch`, or `--use-pch`, if it appears at all, must be the *first* option on the command line.

2.9.4. Performance Issues

The relative overhead incurred in writing out and reading back in a precompiled header file is quite small for reasonably large header files.

In general, it does not cost much to write a precompiled header file out even if it does not end up being used, and if it *is* used it almost always produces a significant speedup in compilation. The problem is that the precompiled header files can be quite large (from a minimum of about 250K bytes to several megabytes or more), and so one probably does not want many of them sitting around.

Thus, despite the faster recompilations, precompiled header processing is not likely to be justified for an arbitrary set of files with nonuniform initial sequences of preprocessing directives. Rather, the greatest benefit occurs when a number of source files can share the same PCH file. The more sharing, the less disk space is consumed. With sharing, the disadvantage of large precompiled header files can be minimized, without giving up the advantage of a significant speedup in compilation times.

Consequently, to take full advantage of header file precompilation, users should expect to reorder the `#include` sections of their source files and/or to group `#include` directives within a commonly used header file.

Below is an example of how this can be done. A common idiom is this:

```
#include "comnfile.h"
#pragma hdrstop
#include ...
```

where `comnfile.h` pulls in, directly and indirectly, a few dozen header files; the `#pragma hdrstop` is inserted to get better sharing with fewer PCH files. The PCH file produced for `comnfile.h` can be a bit over a megabyte in size. Another idiom, used by the source files involved in declaration processing, is this:

```
#include "comnfile.h"
#include "decl_hdrs.h"
#pragma hdrstop
#include ...
```

`decl_hdrs.h` pulls in another dozen header files, and a second, somewhat larger, PCH file is created. In all, the source files of a particular program can share just a few precompiled header files. If disk space were at a premium, you could decide to make `comnfile.h` pull in *all* the header files used -- then, a single PCH file could be used in building the program.

Different environments and different projects will have different needs, but in general, users should be aware that making the best use of the precompiled header support will require some experimentation and probably some minor changes to source code.

Chapter 3. Assembly Language

This chapter describes the most important aspects of the TASKING assembly language for ARM and contains a detailed description of all built-in assembly functions and assembler directives. For a complete overview of the architecture you are using and a description of the assembly instruction set, refer to the target's core reference manual (for example the *ARM Architecture Reference Manual* ARM DDI 0100I [2005, ARM Limited]).

3.1. Assembly Syntax

An assembly program consists of statements. A statement may optionally be followed by a comment. Any source statement can be extended to more lines by including the line continuation character (\) as the last character on the line. The length of a source statement (first line and continuation lines) is only limited by the amount of available memory.

Mnemonics, directives and other keywords are case insensitive. Labels, symbols, directive arguments, and literal strings are case sensitive.

The syntax of an assembly statement is:

```
[label[:]] [instruction | directive | macro_call] [;comment]
```

label

A label is a special symbol which is assigned the value and type of the current program location counter. A label can consist of letters, digits and underscore characters (_). The first character cannot be a digit. The label can also be a *number*. A label which is prefixed by whitespace (spaces or tabs) has to be followed by a colon (:). The size of an identifier is only limited by the amount of available memory.

number is a number ranging from 1 to 255. This type of label is called a *numeric label* or *local label*. To refer to a numeric label, you must put an **n** (next) or **p** (previous) immediately after the label. This is required because the same label number may be used repeatedly.

Examples:

```
    LAB1: ; This label is followed by a colon and
          ; can be prefixed by whitespace
LAB1    ; This label has to start at the beginning
          ; of a line
1: b lp  ; This is an endless loop
          ; using numeric labels
```

- instruction* An instruction consists of a mnemonic and zero, one or more operands. It must not start in the first column.
- All instructions of the ARM Unified Assembler Language (UAL) are supported. With assembler option `--old-syntax` you can specify to use the pre-UAL syntax. VFP instructions are only supported in the UAL syntax.
- Operands are described in [Section 3.3, Operands of an Assembly Instruction](#). The instructions are described in the target's core Architecture Reference Manual.
- The instruction can also be a so-called 'generic instruction'. Generic instructions are pseudo instructions (no instructions from the instruction set). Depending on the situation in which a generic instruction is used, the assembler replaces the generic instruction with appropriate real assembly instruction(s). For a complete list, see [Section 3.11, Generic Instructions](#).
- directive* With directives you can control the assembler from within the assembly source. Except for preprocessing directives, these must not start in the first column. Directives are described in [Section 3.9, Assembler Directives](#).
- macro_call* A call to a previously defined macro. It must not start in the first column. See [Section 3.10, Macro Operations](#).
- comment* Comment, preceded by a ; (semicolon).

You can use empty lines or lines with only comments.

3.2. Assembler Significant Characters

You can use all ASCII characters in the assembly source both in strings and in comments. Also the extended characters from the ISO 8859-1 (Latin-1) set are allowed.

Some characters have a special meaning to the assembler. Special characters associated with expression evaluation are described in [Section 3.6.3, Expression Operators](#). Other special assembler characters are:

Character	Description
;	Start of a comment
\	Line continuation character or macro operator: argument concatenation
?	Macro operator: return decimal value of a symbol
%	Macro operator: return hex value of a symbol
^	Macro operator: override local label
"	Macro string delimiter or quoted string .DEFINE expansion character
'	String constants delimiter
@	Start of a built-in assembly function
\$	Location counter substitution
#	Immediate addressing

Character	Description
++	String concatenation operator
[]	Load and store addressing mode

3.3. Operands of an Assembly Instruction

In an instruction, the mnemonic is followed by zero, one or more operands. An operand has one of the following types:

Operand	Description
<i>symbol</i>	A symbolic name as described in Section 3.4, <i>Symbol Names</i> . Symbols can also occur in expressions.
<i>register</i>	Any valid register as listed in Section 3.5, <i>Registers</i> .
<i>expression</i>	Any valid expression as described in Section 3.6, <i>Assembly Expressions</i> .
<i>address</i>	A combination of <i>expression</i> , <i>register</i> and <i>symbol</i> .

Addressing modes

The ARM assembly language has several addressing modes. These are described in detail in the target's core Architecture Reference Manual.

3.4. Symbol Names

User-defined symbols

A user-defined *symbol* can consist of letters, digits and underscore characters (`_`). The first character cannot be a digit. The size of an identifier is only limited by the amount of available memory. The case of these characters is significant. You can define a symbol by means of a label declaration or an equate or set directive.

Predefined preprocessor symbols

These symbols start and end with two underscore characters, `__symbol__`, and you can use them in your assembly source to create conditional assembly. See [Section 3.4.1, *Predefined Preprocessor Symbols*](#).

Labels

Symbols used for memory locations are referred to as labels. It is allowed to use reserved symbols as labels as long as the label is followed by a colon or starts at the first column.

Reserved symbols

Symbol names and other identifiers beginning with a period (.) are reserved for the system (for example for directives or section names). Instructions and registers are also reserved. The case of these built-in symbols is insignificant.

Examples

Valid symbol names:

```
loop_1
ENTRY
a_B_c
_aBC
```

Invalid symbol names:

```
1_loop      ; starts with a number
.DEFINE     ; reserved directive name
```

3.4.1. Predefined Preprocessor Symbols

The TASKING assembler knows the predefined symbols as defined in the table below. The symbols are useful to create conditional assembly.

Symbol	Description
<code>__ASARM__</code>	Expands to 1 for the ARM toolset, otherwise unrecognized as macro.
<code>__BUILD__</code>	Identifies the build number of the assembler, composed of decimal digits for the build number, three digits for the major branch number and three digits for the minor branch number. For example, if you use build 1.22.1 of the assembler, <code>__BUILD__</code> expands to 1022001. If there is no branch number, the branch digits expand to zero. For example, build 127 results in 127000000.
<code>__REVISION__</code>	Expands to the revision number of the assembler. Digits are represented as they are; characters (for prototypes, alphas, betas) are represented by -1. Examples: v1.0r1 -> 1, v1.0rb -> -1
<code>__TASKING__</code>	Identifies the assembler as a TASKING assembler. Expands to 1 if a TASKING assembler is used.
<code>__VERSION__</code>	Identifies the version number of the assembler. For example, if you use version 2.1r1 of the assembler, <code>__VERSION__</code> expands to 2001 (dot and revision number are omitted, minor version number in 3 digits).

Example

```
.if @defined('__ASARM__')
    ; this part is only for the asarm assembler
...
#endif
```

3.5. Registers

The following register names, either uppercase or lowercase, should not be used for user-defined symbol names in an assembly language source file:

```
R0 .. R15    (general purpose registers)
IP (alias for R12)
SP (alias for R13)
LR (alias for R14)
PC (alias for R15)
```

3.6. Assembly Expressions

An expression is a combination of symbols, constants, operators, and parentheses which represent a value that is used as an operand of an assembler instruction (or directive).

Expressions can contain user-defined labels (and their associated integer or floating-point values), and any combination of integers, floating-point numbers, or ASCII literal strings.

Expressions follow the conventional rules of algebra and boolean arithmetic.

Expressions that can be evaluated at assembly time are called *absolute expressions*. Expressions where the result is unknown until all sections have been combined and located, are called *relocatable* or *relative expressions*.

When any operand of an expression is relocatable, the entire expression is relocatable. Relocatable expressions are emitted in the object file and evaluated by the linker. Relocatable expressions can only contain integral functions; floating-point functions and numbers are not supported by the ELF/DWARF object format.

The assembler evaluates expressions with 64-bit precision in two's complement.

The syntax of an *expression* can be any of the following:

- *numeric constant*
- *string*
- *symbol*
- *expression binary_operator expression*
- *unary_operator expression*
- *(expression)*
- *function call*

All types of expressions are explained in separate sections.

3.6.1. Numeric Constants

Numeric constants can be used in expressions. If there is no prefix, by default the assembler assumes the number is a decimal number. Prefixes can be used in either lowercase or uppercase.

Base	Description	Example
Binary	A 0b prefix followed by binary digits (0,1). Or use a b suffix.	0B1101 11001010b
Hexadecimal	A 0x prefix followed by hexadecimal digits (0-9, A-F, a-f). Or use a h suffix.	0x12FF 0x45 0fa10h
Decimal integer	Decimal digits (0-9).	12 1245
Decimal floating-point	Decimal digits (0-9), includes a decimal point, or an 'E' or 'e' followed by the exponent.	6E10 .6 3.14 2.7e10

3.6.2. Strings

ASCII characters, enclosed in single (') or double (") quotes constitute an ASCII string. Strings between double quotes allow symbol substitution by a `.DEFINE` directive, whereas strings between single quotes are always literal strings. Both types of strings can contain escape characters.

Strings constants in expressions are evaluated to a number (each character is replaced by its ASCII value). Strings in expressions can have a size of up to 8 characters or less depending on the operand of an instruction or directive; any subsequent characters in the string are ignored. In this case the assembler issues a warning. An exception to this rule is when a string is used in a `.DB` assembler directive; in that case all characters result in a constant value of the specified size. Null strings have a value of 0.

Examples

```
'ABCD'           ; (0x44434241)
''79'           ; to enclose a quote double it
"A\"BC"         ; or to enclose a quote escape it
'AB'+1          ; (0x4341) string used in expression
''             ; null string
.DW 'abcdef'    ; (0x64636261) 'ef' are ignored
                ; warning: string value truncated
'ab'++'cd'      ; you can concatenate
                ; two strings with the '++' operator.
                ; This results in 'abcd'
```

3.6.3. Expression Operators

The next table shows the assembler operators. They are ordered according to their precedence. Operators of the same precedence are evaluated left to right. Parenthetical expressions have the highest priority (innermost first).

Valid operands include numeric constants, literal ASCII strings and symbols.

Most assembler operators can be used with both integer and floating-point values. If one operand has an integer value and the other operand has a floating-point value, the integer is converted to a floating-point value before the operator is applied. The result is a floating-point value.

Type	Operator	Name	Description
	()	parenthesis	Expressions enclosed by parenthesis are evaluated first.
Unary	+	plus	Returns the value of its operand.
	-	minus	Returns the negative of its operand.
	~	one's complement	Integer only. Returns the one's complement of its operand. It cannot be used with a floating-point operand.
	!	logical negate	Returns 1 if the operands' value is 0; otherwise 0. For example, if <code>buf</code> is 0 then <code>!buf</code> is 1. If <code>buf</code> has a value of 1000 then <code>!buf</code> is 0.
Arithmetic	*	multiplication	Yields the product of its operands.
	/	division	Yields the quotient of the division of the first operand by the second. For integer operands, the divide operation produces a truncated integer result.
	%	modulo	Integer only. This operator yields the remainder from the division of the first operand by the second.
	+	addition	Yields the sum of its operands.
	-	subtraction	Yields the difference of its operands.
Shift	<<	shift left	Integer only. Causes the left operand to be shifted to the left (and zero-filled) by the number of bits specified by the right operand.
	>>	shift right	Integer only. Causes the left operand to be shifted to the right by the number of bits specified by the right operand. The sign bit will be extended.

Type	Operator	Name	Description
Relational	<	less than	Returns an integer 1 if the indicated condition is TRUE or an integer 0 if the indicated condition is FALSE.
	<=	less than or equal	
	>	greater than	
	>=	greater than or equal	For example, if D has a value of 3 and E has a value of 5, then the result of the expression $D < E$ is 1, and the result of the expression $D > E$ is 0.
	==	equal	
	!=	not equal	Use tests for equality involving floating-point values with caution, since rounding errors could cause unexpected results.
Bitwise	&	AND	Integer only. Yields the bitwise AND function of its operand.
		OR	Integer only. Yields the bitwise OR function of its operand.
	^	exclusive OR	Integer only. Yields the bitwise exclusive OR function of its operands.
Logical	&&	logical AND	Returns an integer 1 if both operands are non-zero; otherwise, it returns an integer 0.
		logical OR	Returns an integer 1 if either of the operands is non-zero; otherwise, it returns an integer 1

The relational operators and logical operators are intended primarily for use with the conditional assembly `.if` directive, but can be used in any expression.

3.7. Working with Sections

Sections are absolute or relocatable blocks of contiguous memory that can contain code or data. Some sections contain code or data that your program declared and uses directly, while other sections are created by the compiler or linker and contain debug information or code or data to initialize your application. These sections can be named in such a way that different modules can implement different parts of these sections. These sections are located in memory by the linker (using the linker script language, LSL) so that concerns about memory placement are postponed until after the assembly process.

All instructions and directives which generate data or code must be within an active section. The assembler emits a warning if code or data starts without a section definition. The compiler automatically generates sections. If you program in assembly you have to define sections yourself.

For more information about locating sections see [Section 7.7.8, The Section Layout Definition: Locating Sections](#).

Section definition

Sections are defined with the `.SECTION/.ENDSEC` directive and have a name. The names have a special meaning to the locating process and have to start with a predefined name, optionally extended by a dot

'.' and a user defined name. Optionally, you can specify the `at ()` attribute to locate a section at a specific address.

```
.SECTION  name[,at(address)]
; instructions etc.
.ENDSEC
```

See the description of the [.SECTION directive](#) for more information.

Examples

```
.SECTION .data                ; Declare a .data section
; ...
.ENDSEC

.SECTION .data.abs, at(0x0)   ; Declare a .data.abs section at
                               ; an absolute address

; ...
.ENDSEC
```

3.8. Built-in Assembly Functions

The TASKING assembler has several built-in functions to support data conversion, string comparison, and math computations. You can use functions as terms in any expression.

Syntax of an assembly function

```
@function_name([argument[,argument]...])
```

Functions start with the '@' character and have zero or more arguments, and are always followed by opening and closing parentheses. White space (a blank or tab) is not allowed between the function name and the opening parenthesis and between the (comma-separated) arguments.

The names of assembly functions are case insensitive.

Overview of assembly functions

Function	Description
@ALUPCREL (<i>expr</i> , <i>group</i> [, <i>check</i>])	PC-relative ADD/SUB with operand split
@ARG (' <i>symbol</i> ' <i>expr</i>)	Test whether macro argument is present
@BIGENDIAN ()	Test if assembler generates code for big-endian mode
@CNT ()	Return number of macro arguments
@CPU (' <i>architecture</i> ')	Test if current CPU matches <i>architecture</i>
@DEFINED (' <i>symbol</i> ' <i>symbol</i>)	Test whether <i>symbol</i> exists
@LSB (<i>expr</i>)	Least significant byte of the expression
@LSH (<i>expr</i>)	Least significant half word of the absolute expression

Function	Description
@LSW(<i>expr</i>)	Least significant word of the expression
@MSB(<i>expr</i>)	Most significant byte of the expression
@MSH(<i>expr</i>)	Most significant half word of the absolute expression
@MSW(<i>expr</i>)	Most significant word of the expression
@PRE_UAL()	Test if the assembler runs in pre-UAL syntax mode or in UAL syntax mode by default (option --old-syntax)
@STRCAT(<i>str1</i> , <i>str2</i>)	Concatenate <i>str1</i> and <i>str2</i>
@STRCMP(<i>str1</i> , <i>str2</i>)	Compare <i>str1</i> with <i>str2</i>
@STRLEN(<i>string</i>)	Return length of string
@STRPOS(<i>str1</i> , <i>str2</i> [, <i>start</i>])	Return position of <i>str2</i> in <i>str1</i>
@STRSUB(<i>str</i> , <i>expr1</i> , <i>expr2</i>)	Return substring
@THUMB()	Test if the assembler runs in Thumb mode or in ARM mode by default (option --thumb)

Detailed Description of Built-in Assembly Functions

@ALUPCREL(*expression*,*group*[,*check*])

This function is used internally by the assembler with the generic instructions ADR, ADRL and ADRL. This function returns the PC-relative address of the *expression* for use in these generic instructions. *group* is 0 for ADR, 1 for ADRL or 2 for ADRL.

With *check* you can specify to check for overflow (1 means true, 0 means false). If *check* is omitted, the default is 1.

Example:

```
; The instruction "ADRAL R1,label" expands to
ADRAL R1,PC,@ALUPCREL(label,0,1)
```

@ARG('symbol' | *expression*)

Returns integer 1 if the macro argument represented by *symbol* or *expression* is present, 0 otherwise.

You can specify the argument with a *symbol* name (the name of a macro argument enclosed in single quotes) or with *expression* (the ordinal number of the argument in the macro formal argument list). If you use this function when macro expansion is not active, the assembler issues a warning.

Example:

```
.IF @ARG('TWIDDLE') ;is argument twiddle present?
.IF @ARG(1)         ;is first argument present?
```

@BIGENDIAN()

Returns 1 if the assembler generates code for big-endian mode, returns 0 if the assembler generates code for little-endian mode (this is the default).

@CNT()

Returns the number of macro arguments of the current macro expansion as an integer. If you use this function when macro expansion is not active, the assembler issues a warning.

Example:

```
ARGCOUNT .SET @CNT() ; reserve argument count
```

@CPU('architecture')

Returns 1 if *architecture* corresponds to the architecture that was specified with the option `--cpu=architecture`; 0 otherwise. See also [assembler option --cpu \(Select architecture\)](#).

Example:

```
.IF @CPU('ARMv7EM')      ; true if you specified option --cpu=ARMv7EM
... ; code for the ARMv7EM
.ELIF @CPU('ARMv6M')    ; true if you specified option --cpu=ARMv6M
... ; code for the ARMv6-M
.ELSE
... ; code for other architectures
.ENDIF
```

@DEFINED('symbol' | symbol)

Returns 1 if *symbol* has been defined, 0 otherwise. If *symbol* is quoted, it is looked up as a `.DEFINE` symbol; if it is not quoted, it is looked up as an ordinary symbol, macro or label.

Example:

```
.IF @DEFINED('ANGLE')           ;is symbol ANGLE defined?
.ELSE
.ELSEIF @DEFINED(ANGLE)         ;does label ANGLE exist?
.ELSE

```

@LSB(expression)

Returns the *least* significant byte of the result of the *expression*. The result of the expression is calculated as 16 bits.

Example:

```
.DB @LSB(0x1234) ; stores 0x34
.DB @MSB(0x1234) ; stores 0x12
```

@LSH(*expression*)

Returns the *least* significant half word (bits 0..15) of the result of the absolute *expression*. The result of the expression is calculated as a word (32 bits).

@LSW(*expression*)

Returns the *least* significant word (bits 0..31) of the result of the *expression*. The result of the expression is calculated as a double-word (64 bits).

Example:

```
.DW @LSW(0x12345678) ; stores 0x5678
.DW @MSW(0x123456) ; stores 0x0012
```

@MSB(*expression*)

Returns the *most* significant byte of the result of the *expression*. The result of the expression is calculated as 16 bits.

@MSH(*expression*)

Returns the *most* significant half word (bits 16..31) of the result of the absolute *expression*. The result of the expression is calculated as a word (32 bits). @MSH(*expression*) is equivalent to $((\text{expression} \gg 16) \& 0xffff)$.

@MSW(*expression*)

Returns the *most* significant word of the result of the *expression*. The result of the expression is calculated as a double-word (64 bits).

@PRE_UAL()

Returns 1 if the assembler runs in pre-UAL syntax mode by default, or 0 if the assembler runs in UAL syntax mode (default). This function reflects the setting of the [assembler option --old-syntax](#).

Example:

```
.IF @PRE_UAL() ; true if you specified option --old-syntax
... ; old code
.ELSE
... ; new code, UAL syntax
.ENDIF
```

@STRCAT(*string1*,*string2*)

Concatenates *string1* and *string2* and returns them as a single string. You must enclose *string1* and *string2* either with single quotes or with double quotes.

Example:

```
.DEFINE ID "@STRCAT('TAS','KING')"; ID = 'TASKING'
```

@STRCMP(*string1*,*string2*)

Compares *string1* with *string2* by comparing the characters in the string. The function returns the difference between the characters at the first position where they disagree, or zero when the strings are equal:

<0 if *string1* < *string2*

0 if *string1* == *string2*

>0 if *string1* > *string2*

Example:

```
.IF (@STRCMP(STR,'MAIN'))==0 ; does STR equal 'MAIN'?
```

@STRLEN(*string*)

Returns the length of *string* as an integer.

Example:

```
SLEN .SET @STRLEN('string') ; SLEN = 6
```

@STRPOS(*string1*,*string2*[,*start*])

Returns the position of *string2* in *string1* as an integer. If *string2* does not occur in *string1*, the last string position + 1 is returned.

With *start* you can specify the starting position of the search. If you do not specify *start*, the search is started from the beginning of *string1*.

Example:

```
ID .set @STRPOS('TASKING','ASK') ; ID = 1
ID .set @STRPOS('TASKING','BUG') ; ID = 7
```

@STRSUB(*string*,*expression1*,*expression2*)

Returns the substring from *string* as a string. *expression1* is the starting position within *string*, and *expression2* is the length of the desired string. The assembler issues an error if either *expression1* or *expression2* exceeds the length of string. Note that the first position in a string is position 0.

Example:

```
.DEFINE ID "@STRSUB('TASKING',3,4)"; ID = 'KING'
```

@THUMB()

Returns 1 if the assembler runs in Thumb mode by default or 0 if the assembler runs in ARM mode (default). This function reflects the setting of the [assembler option `--thumb`](#). So, it does not depend on the `.CODE16`, `.CODE32`, `.ARM` or `.THUMB` directive.

If you are in a `.CODE32` part and you specified `--thumb`, `@THUMB()` still returns 1.

3.9. Assembler Directives

An assembler directive is simply a message to the assembler. Assembler directives are not translated into machine instructions. There are three main groups of assembler directives.

- Assembler directives that tell the assembler how to go about translating instructions into machine code. This is the most typical form of assembly directives. Typically they tell the assembler where to put a program in memory, what space to allocate for variables, and allow you to initialize memory with data. When the assembly source is assembled, a location counter in the assembler keeps track of where the code and data is to go in memory.

The following directives fall under this group:

- Assembly control directives
- Symbol definition and section directives
- Data definition / Storage allocation directives
- High Level Language (HLL) directives
- Directives that are interpreted by the macro preprocessor. These directives tell the macro preprocessor how to manipulate your assembly code before it is actually being assembled. You can use these directives to write macros and to write conditional source code. Parts of the code that do not match the condition, will not be assembled at all. Unlike other directives, preprocessor directives can start in the first column.
- Some directives act as assembler options and most of them indeed do have an equivalent assembler (command line) option. The advantage of using a directive is that with such a directive you can overrule the assembler option for a particular part of the code. Directives of this kind are called *controls*. A typical example is to tell the assembler with an option to generate a list file while with the directives `.NOLIST` and `.LIST` you overrule this option for a part of the code that you do not want to appear in the list file. Directives of this kind sometimes are called *controls*.

Each assembler directive has its own syntax. Some assembler directives can be preceded with a label. If you do not precede an assembler directive with a label, you must use white space instead (spaces or tabs). You can use assembler directives in the assembly code as pseudo instructions. The assembler recognizes both uppercase and lowercase for directives.

3.9.1. Overview of Assembler Directives

The following tables provide an overview of all assembler directives. For a detailed description of these directives, refer to [Section 3.9.2, *Detailed Description of Assembler Directives*](#).

Overview of assembly control directives

Directive	Description
<code>.END</code>	Indicates the end of an assembly module
<code>.INCLUDE</code>	Include file
<code>.MESSAGE</code>	Programmer generated message

Overview of symbol definition and section directives

Directive	Description
<code>.ALIAS</code>	Create an alias for a symbol
<code>.EQU</code>	Set permanent value to a symbol
<code>.EXTERN</code>	Import global section symbol
<code>.GLOBAL</code>	Declare global section symbol
<code>.SECTION, .ENDSEC</code>	Start a new section
<code>.SET</code>	Set temporary value to a symbol
<code>.SIZE</code>	Set size of symbol in the ELF symbol table
<code>.SOURCE</code>	Specify name of original C source file
<code>.TYPE</code>	Set symbol type in the ELF symbol table
<code>.WEAK</code>	Mark a symbol as 'weak'

Overview of data definition / storage allocation directives

Directive	Description
<code>.ALIGN</code>	Align location counter
<code>.BS, .BSB, .BSH, .BSW, .BSD</code>	Define block storage (initialized)
<code>.DB</code>	Define byte
<code>.DH</code>	Define half word (16 bits)
<code>.DW</code>	Define word (32 bits)
<code>.DD</code>	Define double-word (64 bits)
<code>.DOUBLE</code>	Define a 64-bit floating-point constant
<code>.DS, .DSB, .DSH, .DSW, .DSD</code>	Define storage
<code>.FLOAT</code>	Define a 32-bit floating-point constant

Directive	Description
<code>.OFFSET</code>	Move location counter forwards

Overview of macro preprocessor directives

Directive	Description
<code>.DEFINE</code>	Define substitution string
<code>.BREAK</code>	Break out of current macro expansion
<code>.REPEAT, .ENDREP</code>	Repeat sequence of source lines
<code>.FOR, .ENDFOR</code>	Repeat sequence of source lines n times
<code>.IF, .ELIF, .ELSE</code>	Conditional assembly directive
<code>.ENDIF</code>	End of conditional assembly directive
<code>.MACRO, .ENDM</code>	Define macro
<code>.UNDEF</code>	Undefine <code>.DEFINE</code> symbol or macro

Overview of listing control directives

Directive	Description
<code>.LIST, .NOLIST</code>	Print / do not print source lines to list file
<code>.PAGE</code>	Set top of page/size of page
<code>.TITLE</code>	Set program title in header of assembly list file

Overview of HLL directives

Directive	Description
<code>.CALLS</code>	Pass call tree information and/or stack usage information
<code>.MISRAC</code>	Pass MISRA C information

Overview of ARM specific directives

Directive	Description
<code>.CODE16, .CODE32</code>	Treat instructions as Thumb or ARM instructions using pre-UAL syntax
<code>.THUMB, .ARM</code>	Treat instructions as Thumb or ARM instructions using UAL syntax
<code>.LTOrg</code>	Assemble current literal pool immediately

3.9.2. Detailed Description of Assembler Directives

.ALIAS

Syntax

alias-name **.ALIAS** *symbol-name*

Description

With the **.ALIAS** directive you can create an alias of a symbol. The C compiler generates this directive when you use the `#pragma alias`.

Example

```
exit .ALIAS _Exit
```

Related information

[Pragma alias](#)

.ALIGN

Syntax

```
.ALIGN expression
```

Description

With the `.ALIGN` directive you instruct the assembler to align the location counter. By default the assembler aligns on one byte.

When the assembler encounters the `.ALIGN` directive, it advances the location counter to an address that is aligned as specified by *expression* and places the next instruction or directive on that address. The alignment is in minimal addressable units (MAUs). The assembler fills the 'gap' with NOP instructions for code sections or with zeros for data sections. If the location counter is already aligned on the specified alignment, it remains unchanged. The location of absolute sections will not be changed.

The *expression* must be a power of two: 2, 4, 8, 16, ... If you specify another value, the assembler changes the alignment to the next higher power of two and issues a warning.

The assembler aligns sections automatically to the largest alignment value occurring in that section.

A label is not allowed before this directive.

Example

```
.SECTION .text
.ALIGN 4      ; the assembler aligns
instruction ; this instruction at 4 MAUs and
              ; fills the 'gap' with NOP instructions.
.ENDSEC

.SECTION .text
.ALIGN 3      ; WRONG: not a power of two, the
instruction ; assembler aligns this instruction at
              ; 4 MAUs and issues a warning.
.ENDSEC
```

.BREAK

Syntax

.BREAK

Description

The `.BREAK` directive causes immediate termination of a macro expansion, a `.FOR` loop expansion or a `.REPEAT` loop expansion. In case of nested loops or macros, the `.BREAK` directive returns to the previous level of expansion.

The `.BREAK` directive is, for example, useful in combination with the `.IF` directive to terminate expansion when error conditions are detected.

The assembler does not allow a label with this directive.

Example

```
.FOR MYVAR IN 10 TO 20
... ;
... ; assembly source lines
... ;
  .IF MYVAR > 15
    .BREAK
  .ENDIF
.ENDFOR
```

.BS, .BSB, .BSH, .BSW, .BSD

Syntax

```
[label] .BS count[,value]
[label] .BSB count[,value]
[label] .BSH count[,value]
[label] .BSW count[,value]
[label] .BSD count[,value]
```

Description

With the `.BS` directive the assembler reserves a block of memory. The reserved block of memory is initialized to the value of `value`, or zero if omitted.

With `count` you specify the number of minimum addressable units (MAUs) you want to reserve, and how much the location counter will advance. The expression must be an integer greater than zero and cannot contain any forward references to address labels (labels that have not yet been defined).

With `value` you can specify a value to initialize the block with. Only the least significant MAU of `value` is used. If you omit `value`, the default is zero.

If you specify the optional `label`, it gets the value of the location counter at the start of the directive processing.

You cannot initialize a block of memory in sections with prefix `.bss`. In those sections, the assembler issues a warning and only reserves space, just as with `.DS`.

The `.BSB`, `.BSH`, `.BSW` and `.BSD` directives are variants of the `.BS` directive. The difference is the number of bits that are reserved for the `count` argument:

Directive	Reserved bits
<code>.BSB</code>	8
<code>.BSH</code>	16
<code>.BSW</code>	32
<code>.BSD</code>	64

Example

The `.BSB` directive is for example useful to define and initialize an array that is only partially filled:

```
.section .data
.DB 84,101,115,116 ; initialize 4 bytes
.BSB 96,0xFF      ; reserve another 96 bytes, initialized with 0xFF
.endsec
```

Related Information

[.DB \(Define Memory\)](#)

[.DS \(Define Storage\)](#)

.CALLS

Syntax

```
.CALLS 'caller', 'callee'
```

or

```
.CALLS 'caller', '', stack_usage[, ...]
```

Description

The first syntax creates a call graph reference between *caller* and *callee*. The linker needs this information to build a call graph. *caller* and *callee* are names of functions.

The second syntax specifies stack information. When *callee* is an empty name, this means we define the stack usage of the function itself. The value specified is the stack usage in bytes at the time of the call including the return address. A function can use multiple stacks.

This information is used by the linker to compute the used stack within the application. The information is found in the generated linker map file within the Memory Usage.

This directive is generated by the C compiler. Use the `.CALLS` directive in hand-coded assembly when the assembly code calls a C function. If you manually add `.CALLS` directives, make sure they connect to the compiler generated `.CALLS` directives: the name of the caller must also be named as a callee in another directive.

A label is not allowed before this directive.

Example

```
.CALLS 'main', 'nfunc'
```

Indicates that the function `main` calls the function `nfunc`.

```
.CALLS 'main', '', 8
```

The function `main` uses 8 bytes on the stack.

.CODE16, .CODE32, .THUMB, .ARM**Syntax**

```
.CODE16
.CODE32
.THUMB
.ARM
```

Description

With the `.CODE16` directive you instruct the assembler to interpret subsequent instructions as 16-bit Thumb instructions using the pre-UAL syntax until it encounters another mode directive or till it reaches the end of the active section. This directive causes an implicit alignment of two bytes.

The `.THUMB` directive is the same as the `.CODE16` directive except that the UAL syntax is expected.

With the `.CODE32` directive you instruct the assembler to interpret subsequent instructions as 32-bit ARM instructions using the pre-UAL syntax until it encounters another mode directive or till it reaches the end of the active section. This directive causes an implicit alignment of four bytes. The assembler issues an error message if `.CODE32` is used in combination with option `--cpu=ARMv7M`.

The `.ARM` directive is the same as the `.CODE32` directive except that the UAL syntax is expected.

These directives are useful when you have files that contain both ARM and Thumb instructions. The directive must appear before the instruction change and between a `.SECTION/.ENDSEC`. The default instruction set at the start of a section depends on the use of assembler option `--thumb`.

Example

```
.section .text
.code32
;following instructions are ARM instructions
;
.endsec
```

Related Information

Assembler option `--thumb` (Treat input as Thumb instructions)

.DB, .DH, .DW, .DD

Syntax

```
[label] .DB argument[,argument]...  
[label] .DH argument[,argument]...  
[label] .DW argument[,argument]...  
[label] .DD argument[,argument]...
```

Description

With these directive you can define memory. With each directive the assembler allocates and initializes one or more bytes of memory for each argument.

If you specify the optional *label*, it gets the value of the location counter at the start of the directive processing.

An *argument* can be a single- or multiple-character string constant, an expression or empty. Multiple arguments must be separated by commas with no intervening spaces. Empty arguments are stored as 0 (zero).

The following table shows the number of bits initialized.

Directive	Bits
.DB	8
.DH	16
.DW	32
.DD	64

The value of the arguments must be in range with the size of the directive; floating-point numbers are not allowed. If the evaluated argument is too large to be represented in a half word / word / double-word, the assembler issues a warning and truncates the value.

String constants

Single-character strings are stored in a byte whose lower seven bits represent the ASCII value of the character, for example:

```
.DB 'R' ; = 0x52
```

Multiple-character strings are stored in consecutive byte addresses, as shown below. The standard C language escape characters like '\n' are permitted.

```
.DB 'AB',,'C' ; = 0x41420043 (second argument is empty)
```

Example

When a string is supplied as argument of a directive that initializes multiple bytes, each character in the string is stored in consecutive bytes whose lower seven bits represent the ASCII value of the character. For example:

```
HTBL: .DH 'ABC',,'D' ; results in 0x424100004400 , the 'C' is truncated
WTBL: .DW 'ABC' ; results in 0x43424100
```

Related Information

[.BS](#) (Block Storage)

[.DS](#) (Define Storage)

.DEFINE

Syntax

```
.DEFINE symbol string
```

Description

With the `.DEFINE` directive you define a substitution string that you can use on all following source lines. The assembler searches all succeeding lines for an occurrence of *symbol*, and replaces it with *string*. If the *symbol* occurs in a double quoted string it is also replaced. Strings between single quotes are not expanded.

This directive is useful for providing better documentation in the source program. A *symbol* can consist of letters, digits and underscore characters (`_`), and the first character cannot be a digit.

Macros represent a special case. `.DEFINE` directive translations will be applied to the macro definition as it is encountered. When the macro is expanded, any active `.DEFINE` directive translations will again be applied.

The assembler issues a warning if you redefine an existing symbol.

A label is not allowed before this directive.

Example

Suppose you defined the symbol `LEN` with the substitution string "32":

```
.DEFINE LEN "32"
```

Then you can use the symbol `LEN` for example as follows:

```
.DS LEN  
.MESSAGE "The length is: LEN"
```

The assembler preprocessor replaces `LEN` with "32" and assembles the following lines:

```
.DS 32  
.MESSAGE "The length is: 32"
```

Related Information

`.UNDEF` (Undefine a `.DEFINE` symbol)

`.MACRO`, `.ENDM` (Define a macro)

.DS, .DSB, .DSH, .DSW, .DSD

Syntax

```
[label] .DS expression
[label] .DSB expression
[label] .DSH expression
[label] .DSW expression
[label] .DSD expression
```

Description

With the `.DS` directive the assembler reserves a block in memory. The reserved block of memory is not initialized to any value.

With the *expression* you specify the number of MAUs (Minimal Addressable Units) that you want to reserve, and how much the location counter will advance. The expression must evaluate to an integer greater than zero and cannot contain any forward references (symbols that have not yet been defined).

If you specify the optional *label*, it gets the value of the location counter at the start of the directive processing.

The `.DSB`, `.DSH`, `.DSW` and `.DSD` directives are variants of the `.DS` directive. The difference is the number of bits that are reserved per expression argument:

Directive	Reserved bits
<code>.DSB</code>	8
<code>.DSH</code>	16
<code>.DSW</code>	32
<code>.DSD</code>	64

Example

```
        .section .bss
RES:   .DS 5+3    ; allocate 8 bytes
        .endsec
```

Related Information

[.BS \(Block Storage\)](#)

[.DB \(Define Memory\)](#)

.END

Syntax

.END

Description

With the optional `.END` directive you tell the assembler that the end of the module is reached. If the assembler finds assembly source lines beyond the `.END` directive, it ignores those lines and issues a warning.

You cannot use the `.END` directive in a macro expansion.

The assembler does not allow a label with this directive.

Example

```
.section .text
; source lines
.endsec
.END           ; End of assembly module
```

.EQU

Syntax

symbol **.EQU** *expression*

Description

With the **.EQU** directive you assign the value of *expression* to *symbol* permanently. The expression can be relative or absolute. Once defined, you cannot redefine the symbol. With the **.GLOBAL** directive you can declare the symbol global.

Example

To assign the value 0x400 permanently to the symbol `MYSYMBOL`:

```
MYSYMBOL .EQU 0x4000
```

You cannot redefine the symbol `MYSYMBOL` after this.

Related Information

.SET (Set temporary value to a symbol)

.EXTERN

Syntax

```
.EXTERN symbol[,symbol]. . .
```

Description

With the `.EXTERN` directive you define an *external* symbol. It means that the specified symbol is referenced in the current module, but is not defined within the current module. This symbol must either have been defined outside of any module or declared as globally accessible within another module with the `.GLOBAL` directive.

If you do not use the `.EXTERN` directive and the symbol is not defined within the current module, the assembler issues a warning and inserts the `.EXTERN` directive.

A label is not allowed with this directive.

Example

```
.EXTERN AA,CC,DD ;defined elsewhere
```

Related Information

[.GLOBAL](#) (Declare global section symbol)

.FLOAT, .DOUBLE

Syntax

```
[label].FLOAT expression[,expression]...
```

```
[label].DOUBLE expression[,expression]...
```

Description

With the `.FLOAT` or `.DOUBLE` directive the assembler allocates and initializes a floating-point number (32 bits) or a double (64 bits) in memory for each argument.

An *expression* can be:

- a floating-point expression
- NULL (indicated by two adjacent commas: ,,)

You can represent a constant as a signed whole number with fraction or with the 'e' format as used in the C language. For example, `12.457` and `+0.27E-13` are legal floating-point constants.

If the evaluated argument is too large to be represented in a single word / double-word, the assembler issues an error and truncates the value.

If you specify *label*, it gets the value of the location counter at the start of the directive processing.

Example

```
FLT:  .FLOAT   12.457,+0.27E-13
DBL:  .DOUBLE  12.457,+0.27E-13
```

Related Information

`.DS` (Define Storage)

.FOR, .ENDFOR

Syntax

```
[label] .FOR var IN expression[,expression]...  
    ....  
    .ENDFOR
```

or:

```
[label] .FOR var IN start TO end [STEP step]  
    ....  
    .ENDFOR
```

Description

With the `.FOR/ .ENDFOR` directive you can repeat a block of assembly source lines with an iterator. As shown by the syntax, you can use the `.FOR/ .ENDFOR` in two ways.

1. In the first method, the block of source statements is repeated as many times as the number of arguments following `IN`. If you use the symbol `var` in the assembly lines between `.FOR` and `.ENDFOR`, for each repetition the symbol `var` is substituted by a subsequent expression from the argument list. If the argument is a null, then the block is repeated with each occurrence of the symbol `var` removed. If an argument includes an embedded blank or other assembler-significant character, it must be enclosed with single quotes.
2. In the second method, the block of source statements is repeated using the symbol `var` as a counter. The counter passes all integer values from `start` to `end` with a `step`. If you do not specify `step`, the counter is increased by one for every repetition.

If you specify label, it gets the value of the location counter at the start of the directive processing.

Example

In the following example the block of source statements is repeated 4 times (there are four arguments). With the `.DB` directive you allocate and initialize a byte of memory for each repetition of the loop (a word for the `.DW` directive). Effectively, the preprocessor duplicates the `.DB` and `.DW` directives four times in the assembly source.

```
.FOR VAR1 IN 1,2+3,4,12  
    .DB VAR1  
    .DW (VAR1*VAR1)  
.ENDFOR
```

In the following example the loop is repeated 16 times. With the `.DW` directive you allocate and initialize four bytes of memory for each repetition of the loop. Effectively, the preprocessor duplicates the `.DW` directive 16 times in the assembled file, and substitutes `VAR2` with the subsequent numbers.

```
.FOR VAR2 IN 1 to 0x10  
    .DW (VAR1*VAR1)  
.ENDFOR
```

Related Information

`.REPEAT` , `.ENDREP` (Repeat sequence of source lines)

.GLOBAL

Syntax

```
.GLOBAL symbol[,symbol]. . .
```

Description

All symbols or labels defined in the current section or module are local to the module by default. You can change this default behavior with [assembler option `--symbol-scope=global`](#).

With the `.GLOBAL` directive you declare one or more symbols as global. It means that the specified symbols are defined within the current section or module, and that those definitions should be accessible by all modules.

To access a symbol, defined with `.GLOBAL`, from another module, use the `.EXTERN` directive.

Only program labels and symbols defined with `.EQU` can be made global.

If the symbols that appear in the operand field are not used in the module, the assembler gives a warning.

The assembler does not allow a label with this directive.

Example

```
LOOPA .EQU 1           ; definition of symbol LOOPA
      .GLOBAL LOOPA   ; LOOPA will be globally
                       ; accessible by other modules
```

Related Information

[.EXTERN](#) (Import global section symbol)

.IF, .ELIF, .ELSE, .ENDIF

Syntax

```
.IF expression
.
.
[.ELIF expression] ; the .ELIF directive is optional
.
.
[.ELSE]           ; the .ELSE directive is optional
.
.
.ENDIF
```

Description

With the `.IF/.ENDIF` directives you can create a part of conditional assembly code. The assembler assembles only the code that matches a specified condition.

The *expression* must evaluate to an absolute integer and cannot contain forward references. If *expression* evaluates to zero, the IF-condition is considered FALSE, any non-zero result of *expression* is considered as TRUE.

If the optional `.ELSE` and/or `.ELIF` directives are not present, then the source statements following the `.IF` directive and up to the next `.ENDIF` directive will be included as part of the source file being assembled only if the *expression* had a non-zero result.

If the *expression* has a value of zero, the source file will be assembled as if those statements between the `.IF` and the `.ENDIF` directives were never encountered.

If the `.ELSE` directive is present and *expression* has a nonzero result, then the statements between the `.IF` and `.ELSE` directives will be assembled, and the statement between the `.ELSE` and `.ENDIF` directives will be skipped. Alternatively, if *expression* has a value of zero, then the statements between the `.IF` and `.ELSE` directives will be skipped, and the statements between the `.ELSE` and `.ENDIF` directives will be assembled.

You can nest `.IF` directives to any level. The `.ELSE` and `.ELIF` directive always refer to the nearest previous `.IF` directive.

A label is not allowed with this directive.

Example

Suppose you have an assemble source file with specific code for a test version, for a demo version and for the final version. Within the assembly source you define this code conditionally as follows:

```
.IF TEST
... ; code for the test version
.ELIF DEMO
... ; code for the demo version
.ELSE
```

TASKING VX-toolset for ARM User Guide

```
... ; code for the final version  
.ENDIF
```

Before assembling the file you can set the values of the symbols `TEST` and `DEMO` in the assembly source before the `.IF` directive is reached. For example, to assemble the demo version:

```
TEST .SET 0  
DEMO .SET 1
```

Related Information

[Assembler option `--define`](#) (Define preprocessor macro)

.INCLUDE

Syntax

```
.INCLUDE "filename" | <filename>
```

Description

With the `.INCLUDE` directive you include another file at the exact location where the `.INCLUDE` occurs. This happens before the resulting file is assembled. The `.INCLUDE` directive works similarly to the `#include` statement in C. The source from the include file is assembled as if it followed the point of the `.INCLUDE` directive. When the end of the included file is reached, assembly of the original file continues.

The string specifies the filename of the file to be included. The filename must be compatible with the operating system (forward/backward slashes) and can contain a directory specification. If you omit a filename extension, the assembler assumes the extension `.asm`.

If an absolute pathname is specified, the assembler searches for that file. If a relative path is specified or just a filename, the order in which the assembler searches for include files is:

1. The current directory if you use the `"filename"` construction.

The current directory is not searched if you use the `<filename>` syntax.

2. The path that is specified with the [assembler option `--include-directory`](#).
3. The path that is specified in the environment variable `ASARMINC` when the product was installed.
4. The default `include` directory in the installation directory.

The assembler does not allow a label with this directive.

The state of the assembler is not changed when an include file is processed. The lines of the include file are inserted just as if they belong to the file where it is included.

Example

Suppose that your assembly source file `test.src` contains the following line:

```
.INCLUDE "c:\myincludes\myinc.inc"
```

The assembler issues an error if it cannot find the file at the specified location.

```
.INCLUDE "myinc.inc"
```

The assembler searches the file `myinc.inc` according to the rules described above.

Related Information

[Assembler option `--include-directory`](#) (Add directory to include file search path)

.LIST, .NOLIST

Syntax

```
.NOLIST  
.  
. ; assembly source lines  
.  
.LIST
```

Description

If you generate a list file with the assembler option **--list-file**, you can use the directives `.LIST` and `.NOLIST` to specify which source lines the assembler must write to the list file. Without the assembler option **--list-file** these directives have no effect. The directives take effect starting at the next line.

The assembler prints all source lines to the list file, until it encounters a `.NOLIST` directive. The assembler does not print the `.NOLIST` directive and subsequent source lines. When the assembler encounters the `.LIST` directive, it resumes printing to the list file.

It is possible to nest the `.LIST/.NOLIST` directives.

Example

Suppose you assemble the following assembly code with the assembler option **--list-file**:

```
.SECTION .text  
... ; source line 1  
.NOLIST  
... ; source line 2  
.LIST  
... ; source line 3  
.ENDSEC
```

The assembler generates a list file with the following lines:

```
.SECTION .text  
... ; source line 1  
... ; source line 3  
.ENDSEC
```

Related Information

Assembler option **--list-file** (Generate list file)

.LTORG

Syntax

```
.LTORG
```

Description

With this directive you force the assembler to generate a literal pool (data pocket) at the current location.

All literals from the LDR= pseudo-instructions (except those which could be translated to MOV or MVN instructions) between the previous literal pool and the current location will be assembled in a new literal pool using .DW directives.

By default, the assembler generates a literal pool at the end of a code section, i.e. the .ENDSEC directive at the end of a code section causes an implicit .LTORG directive. However, the default literal pool may be out-of-reach of one or more LDR= pseudo-instructions in the section. In that case the assembler issues an error message and you should insert .LTORG directives at proper locations in the section.

Example

```

.section .text
;
LDR r1,=0x12345678
; code
.ltorg      ; literal pool contains the literal &0x12345678
;
;
.endsec    ; default literal pool is empty

```

Related Information

[LDR= ARM generic instruction](#)

[LDR= Thumb generic instruction](#)

.MACRO, .ENDM

Syntax

```
macro_name .MACRO [argument[,argument]...]
    ...
    macro_definition_statements
    ...
    .ENDM
```

Description

With the `.MACRO` directive you define a macro. Macros provide a shorthand method for handling a repeated pattern of code or group of instructions. You can define the pattern as a macro, and then call the macro at the points in the program where the pattern would repeat.

The definition of a macro consists of three parts:

- *Header*, which assigns a name to the macro and defines the arguments (`.MACRO` directive).
- *Body*, which contains the code or instructions to be inserted when the macro is called.
- *Terminator*, which indicates the end of the macro definition (`.ENDM` directive).

The arguments are symbolic names that the macro processor replaces with the literal arguments when the macro is expanded (called). Each formal *argument* must follow the same rules as symbol names: the name can consist of letters, digits and underscore characters (`_`). The first character cannot be a digit. Argument names cannot start with a percent sign (`%`).

Macro definitions can be nested but the nested macro will not be defined until the primary macro is expanded.

You can use the following operators in macro definition statements:

Operator	Name	Description
<code>\</code>	Macro argument concatenation	Concatenates a macro argument with adjacent alphanumeric characters.
<code>?</code>	Return decimal value of symbol	Substitutes the <code>?symbol</code> sequence with a character string that represents the decimal value of the symbol.
<code>%</code>	Return hex value of symbol	Substitutes the <code>%symbol</code> sequence with a character string that represents the hexadecimal value of the symbol.
<code>"</code>	Macro string delimiter	Allows the use of macro arguments as literal strings.
<code>^</code>	Macro local label override	Prevents name mangling on labels in macros.

Example

The macro definition:

```
macro_a .MACRO arg1,arg2                ;header
    .db arg1                            ;body
```

```
.dw (arg1*arg2)
.ENDM ;terminator
```

The macro call:

```
.section far
macro_a 2,3
.endsec
```

The macro expands as follows:

```
.db 2
.dw (2*3)
```

Related Information

[Section 3.10, *Macro Operations*](#)

[.DEFINE](#) (Define a substitution string)

.MESSAGE

Syntax

```
.MESSAGE type [{str|exp}[,{str|exp}]...]
```

Description

With the `.MESSAGE` directive you tell the assembler to print a message to `stderr` during the assembling process.

With *type* you can specify the following types of messages:

I	Information message. Error and warning counts are not affected and the assembler continues the assembling process.
W	Warning message. Increments the warning count and the assembler continues the assembling process.
E	Error message. Increments the error count and the assembler continues the assembling process.
F	Fatal error message. The assembler immediately aborts the assembling process and generates no object file or list file.

An arbitrary number of strings and expressions, in any order but separated by commas with no intervening white space, can be specified to describe the nature of the generated message. If you use expressions, the assembler outputs the result. The assembler outputs a space between each argument.

The error and warning counts will not be affected. The `.MESSAGE` directive is for example useful in combination with conditional assembly to indicate which part is assembled. The assembling process proceeds normally after the message has been printed.

This directive has no effect on the exit code of the assembler.

A label is not allowed with this directive.

Example

```
.MESSAGE I 'Generating tables'

ID .EQU 4
.MESSAGE E 'The value of ID is',ID

.DEFINE LONG "SHORT"
.MESSAGE I 'This is a LONG string'
.MESSAGE I "This is a LONG string"
```

Within single quotes, the defined symbol `LONG` is not expanded. Within double quotes the symbol `LONG` is expanded so the actual message is printed as:

```
This is a LONG string
This is a SHORT string
```

.MISRAC

Syntax

```
.MISRAC string
```

Description

The C compiler can generate the `.MISRAC` directive to pass the compiler's MISRA C settings to the object file. The linker performs checks on these settings and can generate a report. It is not recommended to use this directive in hand-coded assembly.

Example

```
.MISRAC 'MISRA-C:2004,64,e2,0b,e,e11,27,6,ef83,e1,ef,66,cb75,af1,eff,e7,  
e7f,8d,63,87ff7,6ff3,4'
```

Related Information

Section 4.6.2, *C Code Checking: MISRA C*

C compiler option **--misrac**

.OFFSET

Syntax

```
.OFFSET expression
```

Description

With the `.OFFSET` directive you tell the assembler to give the location counter a new offset relative to the start of the section.

When the assembler encounters the `.OFFSET` directive, it moves the location counter forwards to the specified address, relative to the start of the section, and places the next instruction on that address. If you specify an address equal to or lower than the current position of the location counter, the assembler issues an error.

A label is not allowed with this directive.

Example

```
.SECTION .text
nop
nop
nop
.OFFSET 0x20    ; the assembler places
nop            ; this instruction at address 0x20
               ; relative to the start of the section.
.ENDSEC

.SECTION .text
nop
nop
nop
.OFFSET 0x02    ; WRONG: the current position of the
nop            ; location counter is 0x0C.
.ENDSEC
```

Related Information

[.SECTION](#) (Start a new section)

.PAGE

Syntax

```
.PAGE [pagewidth[,pagelength[,blankleft[,blanktop[,blankbtm]]]]
```

Default

```
.PAGE 132,72,0,0,0
```

Description

If you generate a list file with the assembler option **--list-file**, you can use the directive `.PAGE` to format the generated list file.

The arguments may be any positive absolute integer expression, and must be separated by commas.

<i>pagewidth</i>	Number of columns per line. The default is 132, the minimum is 40.
<i>pagelength</i>	Total number of lines per page. The default is 72, the minimum is 10. As a special case, a page length of 0 turns off page breaks.
<i>blankleft</i>	Number of blank columns at the left of the page. The default is 0, the minimum is 0, and the maximum must maintain the relationship: $blankleft < pagewidth$.
<i>blanktop</i>	Number of blank lines at the top of the page. The default is 0, the minimum is 0 and the maximum must be a value so that $(blanktop + blankbtm) \leq (pagelength - 10)$.
<i>blankbtm</i>	Number of blank lines at the bottom of the page. The default is 0, the minimum is 0 and the maximum must be a value so that $(blanktop + blankbtm) \leq (pagelength - 10)$.

If you use the `.PAGE` directive without arguments, it causes a 'formfeed': the next source line is printed on the next page in the list file. The `.PAGE` directive itself is not printed.

You can omit an argument by using two adjacent commas. If the remaining arguments after an argument are all empty, you can omit them.

Example

```
.PAGE          ; formfeed, the next source line is printed
               ; on the next page in the list file.

.PAGE 96       ; set page width to 96. Note that you can
               ; omit the last four arguments.

.PAGE ,,,3,3   ; use 3 line top/bottom margins.
```

Related Information

`.TITLE` (Set program title in header of assembler list file)

Assembler option **--list-file**

.REPEAT, .ENDREP

Syntax

```
[label] .REPEAT expression
      . . . .
      .ENDREP
```

Description

With the `.REPEAT/.ENDREP` directive you can repeat a sequence of assembly source lines. With *expression* you specify the number of times the loop is repeated. If the *expression* evaluates to a number less than or equal to 0, the sequence of lines will not be included in the assembler output. The *expression* result must be an absolute integer and cannot contain any forward references (symbols that have not already been defined). The `.REPEAT` directive may be nested to any level.

If you specify *label*, it gets the value of the location counter at the start of the directive processing.

Example

In this example the loop is repeated 3 times. Effectively, the preprocessor repeats the source lines (`.DB 10`) three times, then the assembler assembles the result:

```
.REPEAT 3
.DB 10 ; assembly source lines
.ENDFOR
```

Related Information

[.FOR, .ENDFOR](#) (Repeat sequence of source lines *n* times)

.SECTION, .ENDSEC

Syntax

```
.SECTION name[ ,at( address) ]
    . . .
.ENDSEC
```

Description

With the `.SECTION` directive you define a new section. Each time you use the `.SECTION` directive, a new section is created. It is possible to create multiple sections with exactly the same name.

If you define a section, you must always specify the section *name*. The names have a special meaning to the locating process and have to start with a predefined name, optionally extended by a dot '.' and a user defined name. The predefined section name also determines the type of the section (code, data or debug). Optionally, you can specify the `at()` attribute to locate a section at a specific address.

You can use the following predefined section names:

Section name	Description	Section type
<code>.text</code>	Code sections	code
<code>.data</code>	Initialized data	data
<code>.bss</code>	Uninitialized data (cleared)	data
<code>.rodata</code>	ROM data (constants)	data
<code>.debug</code>	Debug sections	debug

Sections of a specified type are located by the linker in a memory space. The space names are defined in a so-called 'linker script file' (files with the extension `.lsl`) delivered with the product in the directory `installation-dir\include.lsl`.

Example

```
.SECTION .data                ; Declare a .data section
    ;
.ENDSEC

.SECTION .data.abs, at(0x0) ; Declare a .data.abs section at
    ; an absolute address
    ;
.ENDSEC
```

Related Information

`.OFFSET` (Move location counter forwards)

.SET

Syntax

```
symbol .SET expression  
  
      .SET symbol expression
```

Description

With the `.SET` directive you assign the value of *expression* to symbol *temporarily*. If a symbol was defined with the `.SET` directive, you can redefine that symbol in another part of the assembly source, using the `.SET` directive again. Symbols that you define with the `.SET` directive are always local: you cannot define the symbol global with the `.GLOBAL` directive.

The `.SET` directive is useful in establishing temporary or reusable counters within macros. *expression* must be absolute and cannot include a symbol that is not yet defined (no forward references are allowed).

Example

```
COUNT .SET 0 ; Initialize count. Later on you can  
      ; assign other values to the symbol
```

Related Information

[.EQU](#) (Set permanent value to a symbol)

.SIZE

Syntax

```
.SIZE symbol,expression
```

Description

With the `.SIZE` directive you set the size of the specified *symbol* to the value represented by *expression*.

The `.SIZE` directive may occur anywhere in the source file unless the specified symbol is a function. In this case, the `.SIZE` directive must occur after the function has been defined.

Example

```
        .section          .text
        .global main
        .arm
        .align 4
; Function main
main:   .type  func
        ;
        .SIZE  main,$-main
        .endsec
```

Related Information

`.TYPE` (Set symbol type)

.SOURCE

Syntax

```
.SOURCE string
```

Description

With the `.SOURCE` directive you specify the name of the original C source module. This directive is generated by the C compiler. You do not need this directive in hand-written assembly.

Example

```
.SOURCE "main.c"
```

.TITLE

Syntax

```
.TITLE ["string"]
```

Default

```
.TITLE ""
```

Description

If you generate a list file with the assembler option **--list-file**, you can use the `.TITLE` directive to specify the program title which is printed at the top of each page in the assembler list file.

If you use the `.TITLE` directive without the argument, the title becomes empty. This is also the default. The specified title is valid until the assembler encounters a new `.TITLE` directive.

The `.TITLE` directive itself will not be printed in the source listing.

If the page width is too small for the title to fit in the header, it will be truncated.

Example

```
.TITLE "This is the title"
```

Related Information

[.PAGE](#) (Format the assembler list file)

Assembler option **--list-file**

.TYPE

Syntax

```
symbol .TYPE typeid
```

Description

With the `.TYPE` directive you set a *symbol's* type to the specified value in the ELF symbol table. Valid symbol types are:

`FUNC` The symbol is associated with a function or other executable code.

`OBJECT` The symbol is associated with an object such as a variable, an array, or a structure.

`FILE` The symbol name represents the filename of the compilation unit.

Labels in code sections have the default type `FUNC`. Labels in data sections have the default type `OBJECT`.

Example

```
Afunc: .type func
```

Related Information

`.SIZE` (Set symbol size)

.UNDEF

Syntax

```
.UNDEF symbol
```

Description

With the `.UNDEF` directive you can undefine a substitution string that was previously defined with the `.DEFINE` directive. The substitution string associated with *symbol* is released, and *symbol* will no longer represent a valid `.DEFINE` substitution or macro.

The assembler issues a warning if you redefine an existing symbol.

The assembler does not allow a label with this directive.

Example

The following example undefines the `LEN` substitution string that was previously defined with the `.DEFINE` directive:

```
.UNDEF LEN
```

Related Information

[.DEFINE](#) (Define a substitution string)

[.MACRO](#) , [.ENDM](#) (Define a macro)

.WEAK

Syntax

```
.WEAK symbol [,symbol]...
```

Description

With the `.WEAK` directive you mark one or more symbols as 'weak'. The *symbol* can be defined in the same module with the `.GLOBAL` directive or the `.EXTERN` directive. If the symbol does not already exist, it will be created.

A 'weak' external reference is resolved by the linker when a global (or weak) definition is found in one of the object files. However, a weak reference will not cause the extraction of a module from a library to resolve the reference.

You can overrule a weak definition with a `.GLOBAL` definition in another module. The linker will not complain about the duplicate definition, and ignore the weak definition.

Only program labels and symbols defined with `.EQU` can be made weak.

Example

```
LOOPA .EQU 1           ; definition of symbol LOOPA
      .GLOBAL LOOPA   ; LOOPA will be globally
                      ; accessible by other modules
      .WEAK LOOPA     ; mark symbol LOOPA as weak
```

Related Information

[.EXTERN](#) (Import global section symbol)

[.GLOBAL](#) (Declare global section symbol)

3.10. Macro Operations

Macros provide a shorthand method for inserting a repeated pattern of code or group of instructions. You can define the pattern as a macro, and then call the macro at the points in the program where the pattern would repeat.

Some patterns contain variable entries which change for each repetition of the pattern. Others are subject to conditional assembly.

When a macro is called, the assembler executes the macro and replaces the call by the resulting in-line source statements. 'In-line' means that all replacements act as if they are on the same line as the macro call. The generated statements may contain substitutable arguments. The statements produced by a macro can be any processor instruction, almost any assembler directive, or any previously-defined macro. Source statements resulting from a macro call are subject to the same conditions and restrictions as any other statements.

Macros can be nested. The assembler processes nested macros when the outer macro is expanded.

3.10.1. Defining a Macro

The first step in using a macro is to define it.

The definition of a macro consists of three parts:

- *Header*, which assigns a name to the macro and defines the arguments (`.MACRO` directive).
- *Body*, which contains the code or instructions to be inserted when the macro is called.
- *Terminator*, which indicates the end of the macro definition (`.ENDM` directive).

A macro definition takes the following form:

```
macro_name .MACRO [argument[,argument]...]
...
macro_definition_statements
...
.ENDM
```

For more information on the definition see the description of the [.MACRO directive](#).

3.10.2. Calling a Macro

To invoke a macro, construct a source statement with the following format:

```
[label] macro_name [argument[,argument]...] [; comment]
```

where,

<i>label</i>	An optional label that corresponds to the value of the location counter at the start of the macro expansion.
<i>macro_name</i>	The name of the macro. This may not start in the first column.

<i>argument</i>	One or more optional, substitutable arguments. Multiple arguments must be separated by commas.
<i>comment</i>	An optional comment.

The following applies to macro arguments:

- Each argument must correspond one-to-one with the formal arguments of the macro definition. If the macro call does not contain the same number of arguments as the macro definition, the assembler issues a warning.
- If an argument has an embedded comma or space, you must surround the argument by single quotes (').
- You can declare a macro call argument as null in three ways:
 - enter delimiting commas in succession with no intervening spaces

```
macroname ARG1,,ARG3 ; the second argument is a null argument
```

- terminate the argument list with a comma, the arguments that normally would follow, are now considered null

```
macroname ARG1, ; the second and all following arguments are null
```

- declare the argument as a null string
- No character is substituted in the generated statements that reference a null argument.

3.10.3. Using Operators for Macro Arguments

The assembler recognizes certain text operators within macro definitions which allow text substitution of arguments during macro expansion. You can use these operators for text concatenation, numeric conversion, and string handling.

Operator	Name	Description
\	Macro argument concatenation	Concatenates a macro argument with adjacent alphanumeric characters.
?	Return decimal value of symbol	Substitutes the <i>?symbol</i> sequence with a character string that represents the decimal value of the symbol.
%	Return hex value of symbol	Substitutes the <i>%symbol</i> sequence with a character string that represents the hexadecimal value of the symbol.
"	Macro string delimiter	Allows the use of macro arguments as literal strings.
^	Macro local label override	Prevents name mangling on labels in macros.

Example: Argument Concatenation Operator - \

Consider the following macro definition:

```
MAC_A .MACRO reg,val
    sub    r\reg,r\reg,#val
    .ENDM
```

The macro is called as follows:

```
MAC_A 2,1
```

The macro expands as follows:

```
sub r2,r2,#1
```

The macro preprocessor substitutes the character '2' for the argument `reg`, and the character '1' for the argument `val`. The concatenation operator (`\`) indicates to the macro preprocessor that the substitution characters for the arguments are to be concatenated with the characters 'r'.

Without the `\` operator the macro would expand as:

```
sub rreg,rreg,#1
```

which results in an assembler error (invalid operand).

Example: Decimal Value Operator - ?

Instead of substituting the formal arguments with the actual macro call arguments, you can also use the value of the macro call arguments.

Consider the following source code that calls the macro `MAC_A` after the argument `AVAL` has been set to 1.

```
AVAL .SET 1
MAC_A 2,AVAL
```

If you want to replace the argument `val` with the value of `AVAL` rather than with the literal string 'AVAL', you can use the `?` operator and modify the macro as follows:

```
MAC_A .MACRO reg,val
    sub    r\reg,r\reg,#?val
    .ENDM
```

Example: Hex Value Operator - %

The percent sign (`%`) is similar to the standard decimal value operator (`?`) except that it returns the hexadecimal value of a symbol.

Consider the following macro definition:

```
GEN_LAB .MACRO LAB,VAL,STMT
LAB\%VAL STMT
.ENDM
```

The macro is called after NUM has been set to 10:

```
NUM .SET 10
GEN_LAB HEX,NUM,NOP
```

The macro expands as follows:

```
HEXA NOP
```

The %VAL argument is replaced by the character 'A' which represents the hexadecimal value 10 of the argument VAL.

Example: Argument String Operator - "

To generate a literal string, enclosed by single quotes ('), you must use the argument string operator (") in the macro definition.

Consider the following macro definition:

```
STR_MAC .MACRO STRING
.DB "STRING"
.ENDM
```

The macro is called as follows:

```
STR_MAC ABCD
```

The macro expands as follows:

```
.DB 'ABCD'
```

Within double quotes .DEFINE directive definitions can be expanded. Take care when using constructions with single quotes and double quotes to avoid inappropriate expansions. Since .DEFINE expansion occurs before macro substitution, any .DEFINE symbols are replaced first within a macro argument string:

```
.DEFINE LONG 'short'
STR_MAC .MACRO STRING
.MESSAGE I 'This is a LONG STRING'
.MESSAGE I "This is a LONG STRING"
.ENDM
```

If the macro is called as follows:

```
STR_MAC sentence
```

it expands as:

```
.MESSAGE I 'This is a LONG STRING'  
.MESSAGE I 'This is a short sentence'
```

Macro Local Label Override Operator - ^

If you use labels in macros, the assembler normally generates another unique name for the labels (such as LOCAL__M_L000001).

The macro ^-operator prevents name mangling on macro local labels.

Consider the following macro definition:

```
INIT .MACRO  addr  
LOCAL:  ldr   r0, ^addr  
        .ENDM
```

The macro is called as follows:

```
LOCAL:  
    INIT LOCAL
```

The macro expands as:

```
LOCAL__M_L000001:  ldr   r0, LOCAL
```

If you would not have used the ^ operator, the macro preprocessor would choose another name for LOCAL because the label already exists. The macro would expand like:

```
LOCAL__M_L000001:  ldr   r0, LOCAL__M_L000001
```

3.11. Generic Instructions

The assembler supports so-called 'generic instructions'. Generic instructions are pseudo instructions (no instructions from the instruction set). Depending on the situation in which a generic instruction is used, the assembler replaces the generic instruction with appropriate real assembly instruction(s).

3.11.1. ARM Generic Instructions

The ARM assembler recognizes the following generic instructions in ARM mode:

ADR, ADRL, ADRLl ARM generics

Load a PC-relative address into a register. The address is specified as a target label. The assembler generates one (ADR), two (ADRL) or three (ADRLl) generic DPR instruction (called ADR) and one, two or three PC-relative relocation types for the target label. The linker evaluates the relocation types (calculate the PC-relative offset) and generates one, two or three add or sub instructions each with an 8-bit immediate operand plus a 4-bit rotation. If the offset cannot be encoded the linker generates an error message.

Instruction	Replacement
<i>ADRcond Rd,label</i>	<i>ADRcond Rd</i> , PC, @ALUPCREL(<i>label</i> ,0,1)
<i>ADRLcond Rd,label</i>	<i>ADRcond Rd</i> , PC, @ALUPCREL(<i>label</i> ,0,0) <i>ADRcond Rd</i> , <i>Rd</i> , @ALUPCREL(<i>label</i> ,1,1)
<i>ADRLlcond Rd,label</i>	<i>ADRcond Rd</i> , PC, @ALUPCREL(<i>label</i> ,0,0) <i>ADRcond Rd</i> , <i>Rd</i> , @ALUPCREL(<i>label</i> ,1,0) <i>ADRcond Rd</i> , <i>Rd</i> , @ALUPCREL(<i>label</i> ,2,1)

3.11.2. ARM and Thumb-2 32-bit Generic Instructions

LDR= ARM and Thumb-2 generic

Load an address or a 32-bit constant value into a register. If the constant or its bitwise negation can be encoded, then the assembler will generate a MOV or a MVN instruction. Otherwise the assembler places the constant or the address in a literal pool and generates a PC-relative LDR instruction that loads the value from the literal pool.

Instruction	Replacement	Remarks
<i>LDRcond Rd,=expr</i>	<i>MOVcond Rd</i> , # <i>expr</i>	If <i>expr</i> can be encoded
	<i>MVNcond Rd</i> ,#@LSW(~(<i>expr</i>))	If ~ <i>expr</i> can be encoded
	<i>LDRcond Rd</i> , <i>ltpool</i> ;; code <i>ltpool</i> : .DW <i>expr</i>	If <i>expr</i> is external or PC-relative, or cannot be encoded

The PC-relative offset from the LDR instruction to the value in the literal pool must be positive and less than 4 kB. By default the assembler will place a literal pool at the end of each code section. If the default literal pool is out-of-range you will have to ensure that there is another literal pool within range by means of the `.LTOrg` directive.

VLDR= ARM and Thumb-2 generic

Load a 32-bit or 64-bit floating-point constant value into a register. The assembler places the constant in a literal pool and generates a PC-relative VLDR instruction that loads the value from the literal pool.

Instruction	Replacement
<i>VLDRcond Sd,=expr</i>	<i>VLDRcond Sd</i> , <i>ltpool</i> ;; code <i>ltpool</i> : .FLOAT <i>expr</i>
<i>VLDRcond Dd,=expr</i>	<i>VLDRcond Dd</i> , <i>ltpool</i> ;; code <i>ltpool</i> : .DOUBLE <i>expr</i>

MOV32 ARM and Thumb-2 generic

Load an address or a 32-bit constant value into a register.

Instruction	Replacement	Remarks
MOV32 <i>cond</i> Rd,=expr	MOVW <i>cond</i> Rd, #@LSH(expr) MOVT <i>cond</i> Rd, #@MSH(expr)	If <i>expr</i> is internal and absolute
	MOVW <i>cond</i> Rd, #expr MOVT <i>cond</i> Rd, #expr	If <i>expr</i> is external or relocatable

ARM and Thumb-2 generic DPR inversions for immediate operands

For data processing instructions (DPR) which operate on an immediate operand, the operand value must be encoded as an 8-bit value plus a 4-bit even rotation value. If a value does not fit in such an encoding, it could be possible that the negated value (*-value*) or the bitwise negated value (*~value*) does fit in such an encoding. In that case the assembler will replace the DPR instruction by its inverse DPR instruction operating on the negated value.

Instruction	Replacement (if #imm or #~imm can be encoded)
ADD <i>cond</i> Rd,Rn,#imm32	SUB <i>cond</i> Rd,Rn,#-(imm32)
ADD <i>cond</i> S Rd,Rn,#imm32	SUB <i>cond</i> S Rd,Rn,#-(imm32)
ADDW <i>cond</i> Rd,Rn,#imm12	SUBW <i>cond</i> Rd,Rn,#-(imm12)
SUB <i>cond</i> Rd,Rn,#imm32	ADD <i>cond</i> Rd,Rn,#-(imm32)
SUB <i>cond</i> S Rd,Rn,#imm32	ADD <i>cond</i> S Rd,Rn,#-(imm32)
SUBW <i>cond</i> Rd,Rn,#imm12	ADDW <i>cond</i> Rd,Rn,#-(imm12)
ADC <i>cond</i> Rd,Rn,#imm32	SBC <i>cond</i> Rd,Rn,#-(imm32)
ADC <i>cond</i> S Rd,Rn,#imm32	SBC <i>cond</i> S Rd,Rn,#-(imm32)
SBC <i>cond</i> Rd,Rn,#imm32	ADC <i>cond</i> Rd,Rn,#-(imm32)
SBC <i>cond</i> S Rd,Rn,#imm32	ADC <i>cond</i> S Rd,Rn,#-(imm32)
AND <i>cond</i> Rd,Rn,#imm32	BIC <i>cond</i> Rd,Rn,@LSW(~(imm32))
AND <i>cond</i> S Rd,Rn,#imm32	BIC <i>cond</i> S Rd,Rn,@LSW(~(imm32))
BIC <i>cond</i> Rd,Rn,#imm32	AND <i>cond</i> Rd,Rn,@LSW(~(imm32))
BIC <i>cond</i> S Rd,Rn,#imm32	AND <i>cond</i> S Rd,Rn,@LSW(~(imm32))
CMN <i>cond</i> Rn,#imm32	CMP <i>cond</i> Rn,#-(imm)
CMP <i>cond</i> Rn,#imm32	CMN <i>cond</i> Rn,#-(imm)
MOV <i>cond</i> Rd,#imm32	MVN <i>cond</i> Rd,@LSW(~(imm32))
MOV <i>cond</i> S Rd,#imm32	MVN <i>cond</i> S Rd,@LSW(~(imm32))
MVN <i>cond</i> Rd,#imm32	MOV <i>cond</i> Rd,@LSW(~(imm32))
MVN <i>cond</i> S Rd,#imm32	MOV <i>cond</i> S Rd,@LSW(~(imm32))

Note that the built-in function @LSW() must be used on the bitwise negated immediate value because all values are interpreted by the assembler as 64-bit signed values. The @LSW() function returns the lowest 32 bits.

3.11.3. Thumb 16-bit Generic Instructions

The ARM assembler recognizes the following generic instructions in Thumb mode:

ADR Thumb 16-bit generic

Load a PC-relative address into a low register. The address is specified as a target label. The PC-relative offset must be less than 1 kB. The target label must be defined locally, must be word-aligned and must be in the same code section as the instruction. The assembler will not emit a relocation type for the target label. If the offset is out-of-range or the target label is external or in another section, then the assembler generates an error message.

LDR= Thumb 16-bit generic

Load an address or a 32-bit constant value into a low register. If the constant is in the range [0,255] the assembler will generate a MOV instruction. Otherwise the assembler places the constant or the address in a literal pool and generates a PC-relative LDR instruction that loads the value from the literal pool.

Instruction	Replacement	Remarks
LDR <i>Rd</i> ,= <i>expr</i>	MOV <i>Rd</i> , # <i>expr</i>	If <i>expr</i> is in range
	<pre> LDR <i>Rd</i>, <i>ltpool</i> ;; code <i>ltpool</i>: .DW <i>expr</i> </pre>	If <i>expr</i> is external or PC-relative, or not in range

The PC-relative offset from the LDR instruction to the value in the literal pool must be positive and less than 1 kB. By default the assembler will place a literal pool at the end of each code section. If the default literal pool is out-of-range you will have to ensure that there is another literal pool within range by means of the `.LTORG` directive.

Bcond inversion Thumb 16-bit generic

The PC-relative conditional branch instruction has a range of (-256,+255) bytes. The unconditional version has a range of (-2048,+2047) bytes. If the conditional branch target is out-of-range, the assembler will rewrite the conditional branch instruction with an inversed conditional branch and an unconditional branch.

Instruction	Replacement	Remarks
Bcond <i>label</i>	<pre> Binv_cond ~1 B <i>label</i> ~1: </pre>	If target <i>label</i> out-of-range

ADD, SUB inversions Thumb 16-bit generic

For the following six instructions the assembler accepts negative values for the immediate operand. If a negative value is specified, the assembler inverts the instruction from ADD to SUB or vice versa. For example: ADD R1,#-4 will be rewritten as SUB R1,#4.

Instruction	Replacement
ADD <i>Rd,Rn,#imm</i>	SUB <i>Rd,Rn,#-(imm)</i>
ADD <i>Rd,#imm</i>	SUB <i>Rd,#-(imm)</i>
ADD SP,# <i>imm</i>	SUB SP,#-(<i>imm</i>)
SUB <i>Rd,Rn,#imm</i>	ADD <i>Rd,Rn,#-(imm)</i>
SUB <i>Rd,#imm</i>	ADD <i>Rd,#-(imm)</i>
SUB SP,# <i>imm</i>	ADD SP,#-(<i>imm</i>)

Chapter 4. Using the C Compiler

This chapter describes the compilation process and explains how to call the C compiler.

The TASKING VX-toolset for ARM under Eclipse uses the TASKING makefile generator and make utility to build your entire embedded project, from C source till the final ELF/DWARF object file which serves as input for the debugger.

Although in Eclipse you cannot run the C compiler separately from the other tools, this section discusses the options that you can specify for the C compiler.

On the command line it is possible to call the C compiler separately from the other tools. However, it is recommended to use the control program for command line invocations of the toolset (see [Section 9.1, Control Program](#)). With the control program it is possible to call the entire toolset with only one command line.

The C compiler takes the following files for input and output:

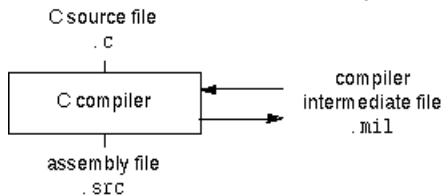

This chapter first describes the compilation process which consists of a *frontend* and a *backend* part. Next it is described how to call the C compiler and how to use its options. An extensive list of all options and their descriptions is included in [Section 11.2, C Compiler Options](#). Finally, a few important basic tasks are described, such as including the C startup code and performing various optimizations.

4.1. Compilation Process

During the compilation of a C program, the C compiler runs through a number of phases that are divided into two parts: *frontend* and *backend*.

The backend part is not called for each C statement, but starts after a complete C module or set of modules has been processed by the frontend (in memory). This allows better optimization.

The C compiler requires only one pass over the input file which results in relative fast compilation.

Frontend phases

1. The preprocessor phase:

The preprocessor includes files and substitutes macros by C source. It uses only string manipulations on the C source. The syntax for the preprocessor is independent of the C syntax but is also described in the ISO/IEC 9899:1999(E) standard.

TASKING VX-toolset for ARM User Guide

2. The scanner phase:

The scanner converts the preprocessor output to a stream of tokens.

3. The parser phase:

The tokens are fed to a parser for the C grammar. The parser performs a syntactic and semantic analysis of the program, and generates an intermediate representation of the program. This code is called MIL (Medium level Intermediate Language).

4. The frontend optimization phase:

Target processor independent optimizations are performed by transforming the intermediate code.

Backend phases

1. Instruction selector phase:

This phase reads the MIL input and translates it into Low level Intermediate Language (LIL). The LIL objects correspond to a processor instruction, with an opcode, operands and information used within the C compiler.

2. Peephole optimizer/instruction scheduler/software pipelining phase:

This phase replaces instruction sequences by equivalent but faster and/or shorter sequences, rearranges instructions and deletes unnecessary instructions.

3. Register allocator phase:

This phase chooses a physical register to use for each virtual register.

4. The backend optimization phase:

Performs target processor independent and dependent optimizations which operate on the Low level Intermediate Language.

5. The code generation/formatter phase:

This phase reads through the LIL operations to generate assembly language output.

4.2. Calling the C Compiler

The TASKING VX-toolset for ARM under Eclipse uses the TASKING makefile generator and make utility to build your entire project. After you have built your project, the output files are available in a subdirectory of your project directory, depending on the active configuration you have set in the **C/C++ Build » Settings** page of the **Project » Properties for** dialog.

Building a project under Eclipse

You have several ways of building your project:

- Build Individual Project (🔧).

To build individual projects incrementally, select **Project » Build project**.

- Rebuild Project (🔄). This builds every file in the project whether or not a file has been modified since the last build. A rebuild is a clean followed by a build.

1. Select **Project » Clean...**

2. Enable the option **Start a build immediately** and click **OK**.

- Build Automatically. This performs a build of all projects whenever any project file is saved, such as your makefile.

This way of building is not recommended for C/C++ development, but to enable this feature select **Project » Build Automatically** and ensure there is a check mark beside the **Build Automatically** menu item. In order for this option to work, you must also enable option **Build on resource save (Auto build)** on the **Behavior** tab of the **C/C++ Build** page of the **Project » Properties for** dialog.

See also [Chapter 12, Influencing the Build Time](#).

Select a target processor (core)

Processor options affect the invocation of all tools in the toolset. In Eclipse you need to set them for each configuration. Based on the target processor, the compiler includes a special function register file. This is a regular include file which enables you to use virtual registers that are located in memory.

You can specify the target processor when you create a new project with the New C/C++ Project wizard (**File » New » TASKING ARM C/C++ Project**), but you can always change the processor in the project properties dialog.

1. From the **Project** menu, select **Properties for**

The Properties dialog appears.

2. In the left pane, expand **C/C++ Build** and select **Processor**.

In the right pane the Processor page appears.

3. From the **Configuration** list, select a configuration or select [All configurations].

4. From the **Processor selection** list, select a processor.

To access the C/C++ compiler options

1. From the **Project** menu, select **Properties for**

The Properties dialog appears.

TASKING VX-toolset for ARM User Guide

2. In the left pane, expand **C/C++ Build** and select **Settings**.

In the right pane the Settings appear.

3. From the **Configuration** list, select a configuration or select [All configurations].
4. On the Tool Settings tab, select **C/C++ Compiler**.
5. Select the sub-entries and set the options in the various pages.

Note that the C/C++ compiler options are used to create an object file from a C or C++ file. The options you enter in the Assembler page are not only used for hand-coded assembly files, but also for intermediate assembly files.

You can find a detailed description of all C compiler options in [Section 11.2, C Compiler Options](#).

Invocation syntax on the command line:

```
carm [ [option]... [file]... ]...
```

4.3. How the Compiler Searches Include Files

When you use include files (with the `#include` statement), you can specify their location in several ways. The compiler searches the specified locations in the following order:

1. If the `#include` statement contains an absolute pathname, the compiler looks for this file. If no path or a relative path is specified, the compiler looks in the same directory as the source file. This is only possible for include files that are enclosed in "".

This first step is not done for include files enclosed in <>.

2. When the compiler did not find the include file, it looks in the directories that are specified in the **C/C++ Compiler » Include Paths** page in the **C/C++ Build » Settings » Tool Settings** tab of the Project Properties dialog (equivalent to [option `--include-directory \(-I\)`](#)). If the option **Add CMSIS include paths** is enabled, this path is search first.
3. When the compiler did not find the include file (because it is not in the specified include directory or because no directory is specified), it looks in the path(s) specified in the environment variable `CARMINC`.
4. When the compiler still did not find the include file, it finally tries the default include directory relative to the installation directory (unless you specified [option `--no-stdinc`](#)).

Example

Suppose that the C source file `test.c` contains the following lines:

```
#include <stdio.h>
#include "myinc.h"
```

You can call the compiler as follows:

```
carml -Imyinclude test.c
```

First the compiler looks for the file `stdio.h` in the directory `myinclude` relative to the current directory. If it was not found, the compiler searches in the environment variable `CARMINC` and then in the default `include` directory.

The compiler now looks for the file `myinc.h`, in the directory where `test.c` is located. If the file is not there the compiler searches in the directory `myinclude`. If it was still not found, the compiler searches in the environment variable `CARMINC` and then in the default `include` directory.

4.4. Compiling for Debugging

Compiling your files is the first step to get your application ready to run on a target. However, during development of your application you first may want to debug your application.

To create an object file that can be used for debugging, you must instruct the compiler to include symbolic debug information in the source file.

To include symbolic debug information

1. From the **Project** menu, select **Properties for**
The Properties dialog appears.
2. In the left pane, expand **C/C++ Build** and select **Settings**.
In the right pane the Settings appear.
3. On the Tool Settings tab, select **C/C++ Compiler » Debugging**.
4. Select **Default** in the **Generate symbolic debug information** box.

Debug and optimizations

Due to different compiler optimizations, it might be possible that certain debug information is optimized away. Therefore, if you encounter strange behavior during debugging it might be necessary to reduce the optimization level, so that the source code is still suitable for debugging. For more information on optimization see [Section 4.5, Compiler Optimizations](#).

Invocation syntax on the command line

The invocation syntax on the command line is:

```
carml -g file.c
```

4.5. Compiler Optimizations

The compiler has a number of optimizations which you can enable or disable.

1. From the **Project** menu, select **Properties for**

The Properties dialog appears.

2. In the left pane, expand **C/C++ Build** and select **Settings**.

In the right pane the Settings appear.

3. From the **Configuration** list, select a configuration or select [All configurations].

4. On the Tool Settings tab, select **C/C++ Compiler » Optimization**.

5. Select an optimization level in the **Optimization level** box.

or:

In the **Optimization level** box select **Custom optimization** and enable the optimizations you want on the Custom optimization page.

Optimization levels

The TASKING C compiler offers four optimization levels and a custom level, at each level a specific set of optimizations is enabled.

- **Level 0 - No optimization:** No optimizations are performed. The compiler tries to achieve a 1-to-1 resemblance between source code and produced code. Expressions are evaluated in the order written in the source code, associative and commutative properties are not used.
- **Level 1 - Optimize:** Enables optimizations that do not affect the debug-ability of the source code. Use this level when you encounter problems during debugging your source code with optimization level 2.
- **Level 2 - Optimize more (default):** Enables more optimizations to reduce the memory footprint and/or execution time. This is the default optimization level.
- **Level 3 - Optimize most:** This is the highest optimization level. Use this level when your program/hardware has become too slow to meet your real-time requirements.
- **Custom optimization:** you can enable/disable specific optimizations on the Custom optimization page.

Optimization pragmas

If you specify a certain optimization, all code in the module is subject to that optimization. Within the C source file you can overrule the C compiler options for optimizations with `#pragma optimize flag` and `#pragma endoptimize`. Nesting is allowed:

```
#pragma optimize e      /* Enable expression  
...                    simplification          */  
... C source ...
```

```

...
#pragma optimize c      /* Enable common expression
...                    elimination. Expression
... C source ...      simplification still enabled */
...
#pragma endoptimize    /* Disable common expression
...                    elimination           */
#pragma endoptimize    /* Disable expression
...                    simplification       */

```

The compiler optimizes the code between the pragma pair as specified.

You can enable or disable the optimizations described in the following subsection. The command line option for each optimization is given in brackets.

4.5.1. Generic Optimizations (frontend)

Common subexpression elimination (CSE) (option -Oc/-OC)

The compiler detects repeated use of the same (sub-)expression. Such a "common" expression is replaced by a variable that is initialized with the value of the expression to avoid recomputation. This method is called common subexpression elimination (CSE).

Expression simplification (option -Oe/-OE)

Multiplication by 0 or 1 and additions or subtractions of 0 are removed. Such useless expressions may be introduced by macros or by the compiler itself (for example, array subscripting).

Constant propagation (option -Op/-OP)

A variable with a known value is replaced by that value.

Automatic function inlining (option -Oi/-OI)

Small functions that are not too often called, are inlined. This reduces execution time at the cost of code size.

Control flow simplification (option -Of/-OF)

A number of techniques to simplify the flow of the program by removing unnecessary code and reducing the number of jumps. For example:

- *Switch optimization*: A number of optimizations of a switch statement are performed, such as removing redundant case labels or even removing an entire switch.
- *Jump chaining*: A (conditional) jump to a label which is immediately followed by an unconditional jump may be replaced by a jump to the destination label of the second jump. This optimization speeds up execution.

TASKING VX-toolset for ARM User Guide

- *Conditional jump reversal:* A conditional jump over an unconditional jump is transformed into one conditional jump with the jump condition reversed. This reduces both the code size and the execution time.
- *Dead code elimination:* Code that is never reached, is removed. The compiler generates a warning messages because this may indicate a coding error.

Subscript strength reduction (option -Os/-OS)

An array or pointer subscripted with a loop iterator variable (or a simple linear function of the iterator variable), is replaced by the dereference of a pointer that is updated whenever the iterator is updated.

Loop transformations (option -O!/-OL)

Transform a loop with the entry point at the bottom, to a loop with the entry point at the top. This enables constant propagation in the initial loop test and code motion of loop invariant code by the CSE optimization.

Forward store (option -Oo/-OO)

A temporary variable is used to cache multiple assignments (stores) to the same non-automatic variable.

MIL linking (Control program option --mil-link)

The frontend phase performs its optimizations on the MIL code. When all C modules and/or MIL modules of an application are given to the C compiler in a single invocation, the C compiler will link MIL code of the modules to a complete application automatically. Next, the frontend will run its optimizations again with application scope. After this, the MIL code is passed on to the backend, which will generate a single `.src` file for the whole application. Linking with the run-time library, floating-point library and C library is still necessary. Linking with the C library is required because this library contains some hand-coded assembly functions, that are not linked in at MIL level.

In the ISO C99 standard a "translation unit" is a preprocessed source file together with all the headers and source files included via the preprocessing directive `#include`. After MIL linking the compiler will treat the linked sources files as a single translation unit, allowing global optimizations to be performed, that otherwise would be limited to a single module.

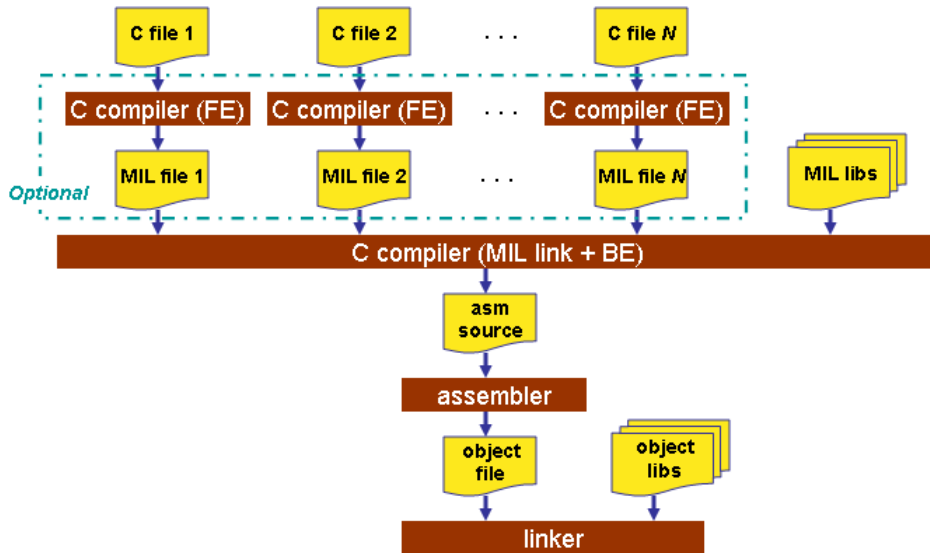

MIL splitting (option `--mil-split`)

When you specify that the C compiler has to use MIL splitting, the C compiler will first link the application at MIL level as described above. However, after rerunning the optimizations the MIL code is not passed on to the backend. Instead the frontend writes a `.ms` file for each input file or library. A `.ms` file has the same format as a `.mil` file. Only `.ms` files that really change are updated. The advantage of this approach is that it is possible to use the make utility to translate only those parts of the application to a `.src` file that really have changed. MIL splitting is therefore a more efficient build process than MIL linking. The penalty for this is that the code compaction optimization in the backend does not have application scope. As with MIL linking, it is still required to link with the normal libraries to build an ELF file.

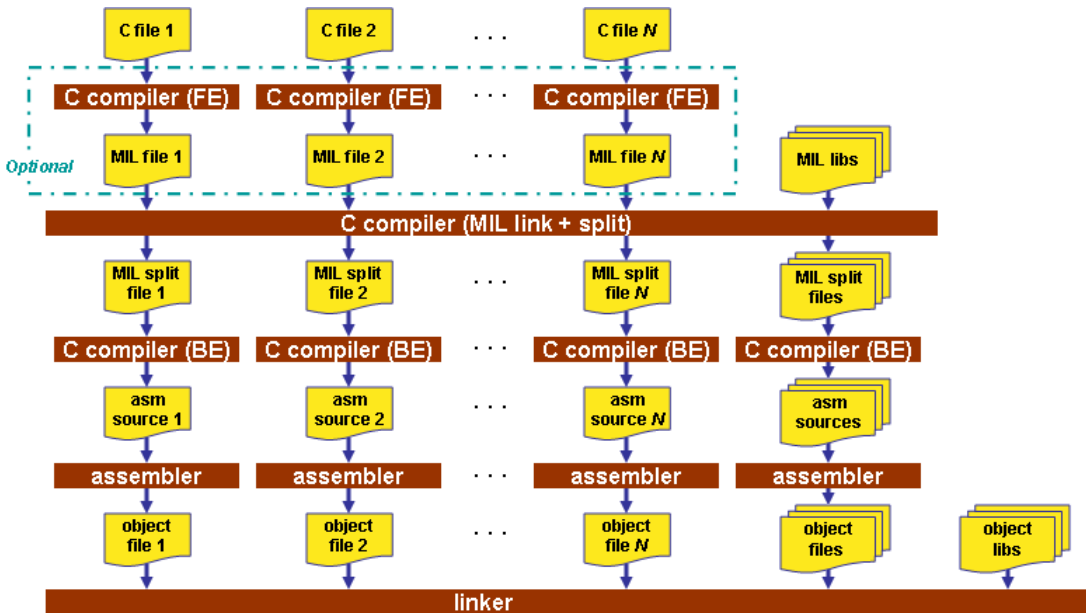

To read more about how MIL linking influences the build process of your application, see [Section 12.1, MIL Linking](#).

4.5.2. Core Specific Optimizations (backend)

Coalescer (option -Oa/-OA)

The coalescer seeks for possibilities to reduce the number of moves (MOV instruction) by smart use of registers. This optimizes both speed and code size.

Interprocedural register optimization (option -Ob/-OB)

Register allocation is improved by taking note of register usage in functions called by a given function.

Peephole optimizations (option -Oy/-OY)

The generated assembly code is improved by replacing instruction sequences by equivalent but faster and/or shorter sequences, or by deleting unnecessary instructions.

Instruction Scheduler (option -Ok/-OK)

The instruction scheduler is a backend optimization that acts upon the generated instructions. When two instructions need the same machine resource - like a bus, register or functional unit - at the same time, they suffer a *structural hazard*, which stalls the pipeline. This optimization tries to rearrange instructions to avoid structural hazards, for example by inserting another non-related instruction.

First the instruction stream is partitioned into basic blocks. A new basic block starts at a label, or right after a jump instruction. Unschedulable instructions and, when **-Av** is enabled, instructions that access

volatile objects, each get their own basic block. Next, the scheduler searches the instructions within a basic block, looking for places where the pipeline stalls. After identifying these places it tries to rebuild the basic block using the existing instructions, while avoiding the pipeline stalls. In this process data dependencies between instructions are honoured.

Note that the function inlining optimization happens in the frontend of the compiler. The instruction scheduler has no knowledge about the origin of the instructions.

Unroll small loops (option `-Ou/-OU`)

To reduce the number of branches, short loops are eliminated by replacing them with a number of copies.

Software pipelining (option `-Ow/-OW`)

A number of techniques to optimize loops. For example, within a loop the most efficient order of instructions is chosen by the *pipeline scheduler* and it is examined what instructions can be executed parallel.

Code compaction (reverse inlining) (option `-Or/-OR`)

Compaction is the opposite of inlining functions: chunks of code that occur more than once, are transformed into a function. This reduces code size at the cost of execution speed. The size of the chunks of code to be inlined depends on the setting of the C compiler option `--tradeoff (-t)`. See the subsection **Code Compaction** in Section 4.5.3, *Optimize for Code Size or Execution Speed*.

Generic assembly optimizations (option `-Og/-OG`)

A set of target independent optimizations that increase speed and decrease code size.

Cluster global variables (option `-O+cluster/-O-cluster`)

Global variables are accessed by first loading their address into a register and then accessing them via this register. Each address will result in an entry in the constant pool. By clustering global variables it is possible to access multiple variables using the same base register, which means we can lower the amount of entries in the constant pool. It also means that potentially we need less base registers. Clustering ensures that the linker locates the global variables together.

4.5.3. Optimize for Code Size or Execution Speed

You can tell the compiler to focus on execution speed or code size during optimizations. You can do this by specifying a size/speed trade-off level from 0 (speed) to 4 (size). This trade-off does not turn optimization phases on or off. Instead, its level is a weight factor that is used in the different optimization phases to influence the heuristics. The higher the level, the more the compiler focusses on code size optimization. To choose a trade-off value read the description below about which optimizations are affected and the impact of the different trade-off values.

Note that the trade-off settings are directions and there is no guarantee that these are followed. The compiler may decide to generate different code if it assessed that this would improve the result.

Optimization hint: Optimizing for size has a speed penalty and vice versa. The advice is to optimize for size by default and only optimize those areas for speed that are critical for the application with respect to speed. Using the tradeoff options **-t0**, **-t1** and **-t2** globally for the application is not recommended.

To specify the size/speed trade-off optimization level:

1. From the **Project** menu, select **Properties for**
The Properties dialog appears.
2. In the left pane, expand **C/C++ Build** and select **Settings**.
In the right pane the Settings appear.
3. On the Tool Settings tab, select **C/C++ Compiler » Optimization**.
4. Select a trade-off level in the **Trade-off between speed and size** box.

See also [C compiler option **-tradeoff \(-t\)**](#)

Instruction Selection

Trade-off levels 0, 1 and 2: the compiler selects the instructions with the smallest number of cycles.

Trade-off levels 3 and 4: the compiler selects the instructions with the smallest number of bytes.

Switch Jump Chain versus Jump Table

Instruction selection for the `switch` statements follows different trade-off rules. A switch statement can result in a jump chain or a jump table. The compiler makes the decision between those by measuring and weighing bytes and cycles. This weigh is controlled with the trade-off values:

Trade-off value	Time	Size
0	100%	0%
1	75%	25%
2	50%	50%
3	25%	75%
4	0%	100%

Loop Optimization

For a top-loop, the loop is entered at the top of the loop. A bottom-loop is entered at the bottom. Every loop has a test and a jump at the bottom of the loop, otherwise it is not possible to create a loop. Some top-loops also have a conditional jump before the loop. This is only necessary when the number of loop iterations is unknown. The number of iterations might be zero, in this case the conditional jump jumps over the loop.

Bottom loops always have an unconditional jump to the loop test at the bottom of the loop.

Trade-off value	Try to rewrite top-loops to bottom-loops	Optimize loops for size/speed
0	no	speed
1	yes	speed
2	yes	speed
3	yes	size
4	yes	size

Example:

```
int a;

void i( int l, int m )
{
    int i;

    for ( i = m; i < l; i++ )
    {
        a++;
    }
    return;
}
```

Coded as a bottom loop (compiled with `--tradeoff=4`) is:

```
        ldr    r2, .L4
        b     .L2          ;; unconditional jump to loop test at bottom
.L3:
        ldr    r3, [r2, #0]
        add   r1, r1, #1
        add   r3, r3, #1
        str   r3, [r2, #0]
.L2:
        cmp   r1, r0
        blt  .L3          ;; loop entry point
```

Coded as a top loop (compiled with `--tradeoff=0`) is:

```
        cmp   r1, r0          ;; test for at least one loop iteration
        ldr   r2, .L4          ;; can be omitted when number of iterations is known
        ldr   r3, [r2, #0]
        bge  .L2
        sub  r0, r0, r1
.L3:
        subs r0, r0, #1
        add  r0, r0, #1
        bgt  .L3          ;; loop entry point
```

```
.L2:  
    str    r3,[r2,#0]
```

Automatic Function Inlining

You can enable automatic function inlining with the option **--optimize=+inline (-Oi)** or by using `#pragma optimize +inline`. This option is also part of the **-O3** predefined option set.

When automatic inlining is enabled, you can use the options **--inline-max-incr** and **--inline-max-size** (or their corresponding pragmas `inline_max_incr / inline_max_size`) to control automatic inlining. By default their values are set to -1. This means that the compiler will select a value depending upon the selected trade-off level. The defaults are:

Trade-off value	inline-max-incr	inline-max-size
0	100	50
1	50	25
2	20	20
3	10	10
4	0	0

For example with trade-off value 1, the compiler inlines all functions that are smaller or equal to 25 internal compiler units. After that the compiler tries to inline even more functions as long as the function will not grow more than 50%.

When these options/pragmas are set to a value ≥ 0 , the specified value is used instead of the values from the table above.

Static functions that are called only once, are always inlined, independent of the values chosen for `inline-max-incr` and `inline-max-size`.

Code Compaction

Trade-off levels 0 and 1: code compaction is disabled.

Trade-off level 2: only code compaction of matches outside loops.

Trade-off level 3: code compaction of matches outside loops, and matches inside loops of patterns that have an estimate execution frequency lower or equal to 10.

Trade-off level 4: code compaction of matches outside loops, and matches inside loops of patterns that have an estimate execution frequency lower or equal to 100.

For loops where the iteration count is unknown an iteration count of 10 is assumed.

For the execution frequency the compiler also accounts nested loops.

See [C compiler option --compact-max-size](#)

Cluster global variables

Clustering of global variables is only done for trade-off level 4.

4.6. Static Code Analysis

Static code analysis (SCA) is a relatively new feature in compilers. Various approaches and algorithms exist to perform SCA, each having specific pros and cons.

SCA Implementation Design Philosophy

SCA is implemented in the TASKING compiler based on the following design criteria:

- An SCA phase does not take up an excessive amount of execution time. Therefore, the SCA can be performed during a normal edit-compile-debug cycle.
- SCA is implemented in the compiler front-end. Therefore, no new makefiles or work procedures have to be developed to perform SCA.
- The number of emitted false positives is kept to a minimum. A false positive is a message that indicates that a correct code fragment contains a violation of a rule/recommendation. A number of warnings is issued in two variants, one variant when it is *guaranteed* that the rule is violated when the code is executed, and the other variant when the rule is *potentially* violated, as indicated by a preceding warning message.

For example see the following code fragment:

```
extern int some_condition(int);
void f(void)
{
    char buf[10];
    int i;

    for (i = 0; i <= 10; i++)
    {
        if (some_condition(i))
        {
            buf[i] = 0; /* subscript may be out of bounds */
        }
    }
}
```

As you can see in this example, if `i=10` the array `buf[]` might be accessed beyond its upper boundary, depending on the result of `some_condition(i)`. If the compiler cannot determine the result of this function at run-time, the compiler issues the warning "subscript is *possibly* out of bounds" preceding the CERT warning "ARR35: do not allow loops to iterate beyond the end of an array". If the compiler can determine the result, or if the `if` statement is omitted, the compiler can guarantee that the "subscript is out of bounds".

TASKING VX-toolset for ARM User Guide

- The SCA implementation has real practical value in embedded system development. There are no real objective criteria to measure this claim. Therefore, the TASKING compilers support well known standards for safety critical software development such as the MISRA guidelines for creating software for safety critical automotive systems and secure "CERT C Secure Coding Standard" released by CERT. CERT is founded by the US government and studies internet and networked systems security vulnerabilities, and develops information to improve security.

Effect of optimization level on SCA results

The SCA implementation in the TASKING compilers has the following limitations:

- Some violations of rules will only be detected when a particular optimization is enabled, because they rely on the analysis done for that optimization, or on the transformations performed by that optimization. In particular, the constant propagation and the CSE/PRE optimizations are required for some checks. It is preferred that you enable these optimizations. These optimizations are enabled with the default setting of the optimization level (**-O2**).
- Some checks require cross-module inspections and violations will only be detected when multiple source files are compiled and linked together by the compiler in a single invocation.

4.6.1. C Code Checking: CERT C

The CERT C Secure Coding Standard provides rules and recommendations for secure coding in the C programming language. The goal of these rules and recommendations is to eliminate insecure coding practices and undefined behaviors that can lead to exploitable vulnerabilities. The application of the secure coding standard will lead to higher-quality systems that are robust and more resistant to attack.

For details about the standard, see the [CERT C Secure Coding Standard](#) web site. For general information about CERT secure coding, see www.cert.org/secure-coding.

Versions of the CERT C standard

Version 1.0 of the CERT C Secure Coding Standard is available as a book by Robert C. Seacord [Addison-Wesley]. Whereas the web site is a wiki and reflects the latest information, the book serves as a fixed point of reference for the development of compliant applications and source code analysis tools.

The rules and recommendations supported by the TASKING compiler reflect the version of the CERT web site as of June 1 2009.

The following rules/recommendations implemented by the TASKING compiler, are not part of the book: [PRE11-C](#), [FLP35-C](#), [FLP36-C](#), [MSC32-C](#)

For a complete overview of the supported CERT C recommendations/rules by the TASKING compiler, see [Chapter 20, CERT C Secure Coding Standard](#).

Priority and Levels of CERT C

Each CERT C rule and recommendation has an assigned *priority*. Three values are assigned for each rule on a scale of 1 to 3 for

- severity - how serious are the consequences of the rule being ignored

1. low (denial-of-service attack, abnormal termination)
 2. medium (data integrity violation, unintentional information disclosure)
 3. high (run arbitrary code)
- likelihood - how likely is it that a flaw introduced by ignoring the rule could lead to an exploitable vulnerability
 1. unlikely
 2. probable
 3. likely
 - remediation cost - how expensive is it to comply with the rule
 1. high (manual detection and correction)
 2. medium (automatic detection and manual correction)
 3. low (automatic detection and correction)

The three values are then multiplied together for each rule. This product provides a measure that can be used in prioritizing the application of the rules. These products range from 1 to 27. Rules and recommendations with a priority in the range of 1-4 are level 3 rules (low severity, unlikely, expensive to repair flaws), 6-9 are level 2 (medium severity, probable, medium cost to repair flaws), and 12-27 are level 1 (high severity, likely, inexpensive to repair flaws).

The TASKING compiler checks most of the level 1 and some of the level 2 CERT C recommendations/rules.

For a complete overview of the supported CERT C recommendations/rules by the TASKING compiler, see [Chapter 20, CERT C Secure Coding Standard](#).

To apply CERT C code checking to your application

1. From the **Project** menu, select **Properties for**
The Properties dialog appears.
2. In the left pane, expand **C/C++ Build** and select **Settings**.
In the right pane the Settings appear.
3. On the Tool Settings tab, select **C/C++ Compiler » CERT C Secure Coding**.
4. Make a selection from the **CERT C secure code checking** list.
5. If you selected **Custom**, expand the **Custom CERT C** entry and enable one or more individual recommendations/rules.

On the command line you can use the [option --cert](#).

```
carm --cert={all | name [-name], ...}
```

With `--diag=cert` you can see a list of the available checks, or you can use a three-letter mnemonic to list only the checks in a particular category. For example, `--diag=pre` lists all supported checks in the preprocessor category.

4.6.2. C Code Checking: MISRA C

The C programming language is a standard for high level language programming in embedded systems, yet it is considered somewhat unsuitable for programming safety-related applications. Through enhanced code checking and strict enforcement of best practice programming rules, TASKING MISRA C code checking helps you to produce more robust code.

MISRA C specifies a subset of the C programming language which is intended to be suitable for embedded automotive systems. It consists of a set of rules, defined in *MISRA-C:2004, Guidelines for the Use of the C Language in Critical Systems* (Motor Industry Research Association (MIRA), 2004).

The compiler also supports MISRA C:1998, the first version of MISRA C and MISRA C: 2012, the latest version of MISRA C. You can select the version with the following C compiler option:

```
--misrac-version=1998
--misrac-version=2004
--misrac-version=2012
```

In your C source files you can check against the MISRA C version used. For example:

```
#if __MISRAC_VERSION__ == 1998
    ...
#elif __MISRAC_VERSION__ == 2004
    ...
#elif __MISRAC_VERSION__ == 2012
    ...
#endif
```

For a complete overview of all MISRA C rules, see [Chapter 21, MISRA C Rules](#).

Implementation issues

The MISRA C implementation in the compiler supports nearly all rules. Only a few rules are not supported because they address documentation, run-time behavior, or other issues that cannot be checked by static source code inspection, or because they require an application-wide overview.

During compilation of the code, violations of the enabled MISRA C rules are indicated with error messages and the build process is halted.

MISRA C rules are divided in mandatory rules, required rules and advisory rules. If rules are violated, errors are generated causing the compiler to stop. With the following options warnings, instead of errors, are generated:

```
--misrac-mandatory-warnings
--misrac-required-warnings
--misrac-advisory-warnings
```

Note that not all MISRA C violations will be reported when other errors are detected in the input source. For instance, when there is a syntax error, all semantic checks will be skipped, including some of the MISRA C checks. Also note that some checks cannot be performed when the optimizations are switched off.

Quality Assurance report

To ensure compliance to the MISRA C rules throughout the entire project, the TASKING linker can generate a MISRA C Quality Assurance report. This report lists the various modules in the project with the respective MISRA C settings at the time of compilation. You can use this in your company's quality assurance system to provide proof that company rules for best practice programming have been applied in the particular project.

To apply MISRA C code checking to your application

1. From the **Project** menu, select **Properties for**
The Properties dialog appears.
2. In the left pane, expand **C/C++ Build** and select **Settings**.
In the right pane the Settings appear.
3. On the Tool Settings tab, select **C/C++ Compiler » MISRA C**.
4. Select the **MISRA C version** (1998, 2004 or 2012).
5. In the **MISRA C checking** box select a MISRA C configuration. Select a predefined configuration for conformance with the required rules in the MISRA C guidelines.
6. (Optional) In the **Custom 1998**, **Custom 2004** or **Custom 2012** entry, specify the individual rules.

On the command line you can use the option `--misrac`.

```
carm --misrac={all | number [-number],...}
```

4.7. C Compiler Error Messages

The C compiler reports the following types of error messages in the Problems view of Eclipse.

F (Fatal errors)

After a fatal error the compiler immediately aborts compilation.

E (Errors)

Errors are reported, but the compiler continues compilation. No output files are produced unless you have set the C compiler option `--keep-output-files` (the resulting output file may be incomplete).

W (Warnings)

Warning messages do not result into an erroneous assembly output file. They are meant to draw your attention to assumptions of the compiler for a situation which may not be correct. You can control warnings in the **C/C++ Build » Settings » Tool Settings » C/C++ Compiler » Diagnostics** page of the **Project » Properties for** menu ([C compiler option --no-warnings](#)).

I (Information)

Information messages are always preceded by an error message. Information messages give extra information about the error.

S (System errors)

System errors occur when internal consistency checks fail and should never occur. When you still receive the system error message

```
S9##: internal consistency check failed - please report
```

please report the error number and as many details as possible about the context in which the error occurred.

Display detailed information on diagnostics

1. From the **Window** menu, select **Show View » Other » TASKING » Problems**.

The Problems view is added to the current perspective.

2. In the Problems view right-click on a message.

A popup menu appears.

3. Select **Detailed Diagnostics Info**.

A dialog box appears with additional information.

On the command line you can use the [C compiler option --diag](#) to see an explanation of a diagnostic message:

```
carm --diag=[format:]{all | number,...}
```



Chapter 5. Using the C++ Compiler

This chapter describes the compilation process and explains how to call the C++ compiler. You should be familiar with the C++ language and with the ISO C language.

The C++ compiler can be seen as a preprocessor or front end which accepts C++ source files or sources using C++ language features. The output generated by the C++ compiler (**cparm**) is intermediate C, which can be translated with the C compiler (**carm**).

The C++ compiler is part of a complete toolset, the TASKING VX-toolset for ARM. For details about the C compiler see [Chapter 4, Using the C Compiler](#).

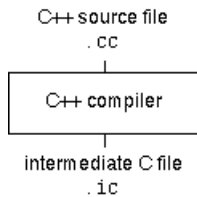
The C++ compiler takes the following files for input and output:



Although in Eclipse you cannot run the C++ compiler separately from the other tools, this section discusses the options that you can specify for the C++ compiler.

On the command line it is possible to call the C++ compiler separately from the other tools. However, it is recommended to use the control program for command line invocations of the toolset (see [Section 9.1, Control Program](#)). With the control program it is possible to call the entire toolset with only one command line. Eclipse also uses the control program to call the C++ compiler. Files with the extensions `.cc`, `.cpp` or `.cxx` are seen as C++ source files and passed to the C++ compiler.

The C++ compiler accepts the C++ language of the ISO/IEC 14882:2003 C++ standard, with some minor exceptions documented in [Chapter 2, C++ Language](#). It also accepts embedded C++ language extensions.

The C++ compiler does no optimization. Its goal is to produce quickly a complete and clean parsed form of the source program, and to diagnose errors. It does complete error checking, produces clear error messages (including the position of the error within the source line), and avoids cascading of errors. It also tries to avoid seeming overly finicky to a knowledgeable C or C++ programmer.

5.1. Calling the C++ Compiler

Under Eclipse you cannot run the C++ compiler separately. However, you can set options specific for the C++ compiler. After you have built your project, the output files are available in a subdirectory of your project directory, depending on the active configuration you have set in the **C/C++ Build » Settings** page of the **Project » Properties for** dialog.

Building a project under Eclipse

You have several ways of building your project:

TASKING VX-toolset for ARM User Guide

- Build Individual Project (🔧).

To build individual projects incrementally, select **Project » Build project**.

- Rebuild Project (🔄). This builds every file in the project whether or not a file has been modified since the last build. A rebuild is a clean followed by a build.

1. Select **Project » Clean...**

2. Enable the option **Start a build immediately** and click **OK**.

- Build Automatically. This performs a build of all projects whenever any project file is saved, such as your makefile.

This way of building is not recommended for C/C++ development, but to enable this feature select **Project » Build Automatically** and ensure there is a check mark beside the **Build Automatically** menu item. In order for this option to work, you must also enable option **Build on resource save (Auto build)** on the **Behavior** tab of the **C/C++ Build** page of the **Project » Properties for** dialog.

Select a target processor (core)

Processor options affect the invocation of all tools in the toolset. In Eclipse you need to set them for each configuration. Based on the target processor, the compiler includes a special function register file. This is a regular include file which enables you to use virtual registers that are located in memory.

1. From the **Project** menu, select **Properties for**

The Properties dialog appears.

2. In the left pane, expand **C/C++ Build** and select **Processor**.

In the right pane the Processor page appears.

3. From the **Configuration** list, select a configuration or select [All configurations].

4. From the **Processor selection** list, select a processor.

To access the C/C++ compiler options

1. From the **Project** menu, select **Properties for**

The Properties dialog appears.

2. In the left pane, expand **C/C++ Build** and select **Settings**.

In the right pane the Settings appear.

3. From the **Configuration** list, select a configuration or select [All configurations].

4. On the Tool Settings tab, select **C/C++ Compiler**.

5. Select the sub-entries and set the options in the various pages.

Note that C++ compiler options are only enabled if you have added a C++ file to your project, a file with the extension `.cc`, `.cpp` or `.cxx`.

Note that the options you enter in the Assembler page are also used for intermediate assembly files.

You can find a detailed description of all C++ compiler options in [Section 11.3, C++ Compiler Options](#).

Invocation syntax on the command line:

```
cparm [ [option]... [file]... ]...
```

5.2. How the C++ Compiler Searches Include Files

When you use include files (with the `#include` statement), you can specify their location in several ways. The C++ compiler searches the specified locations in the following order:

1. If the `#include` statement contains an absolute pathname, the C++ compiler looks for this file. If no path or a relative path is specified, the C++ compiler looks in the same directory as the source file. This is only possible for include files that are enclosed in `"`.

This first step is not done for include files enclosed in `<>`.

2. When the C++ compiler did not find the include file, it looks in the directories that are specified in the **C/C++ Compiler » Include Paths** page in the **C/C++ Build » Settings » Tool Settings** tab of the Project Properties dialog (equivalent to the **--include-directory (-I)** command line option).
3. When the C++ compiler did not find the include file (because it is not in the specified include directory or because no directory is specified), it looks in the path(s) specified in the environment variable `CPPARMINC`.
4. When the C++ compiler still did not find the include file, it finally tries the default `include.cpp` and `include` directory relative to the installation directory.
5. If the include file is still not found, the directories specified in the **--sys-include** option are searched.

If the include directory is specified as `-`, e.g., **-I**, the option indicates the point in the list of **-I** or **--include-directory** options at which the search for file names enclosed in `<...>` should begin. That is, the search for `<...>` names should only consider directories named in **-I** or **--include-directory** options following the **-I**, and the directories of items 3 and 4 above. **-I** also removes the directory containing the current input file (item 1 above) from the search path for file names enclosed in `"..."`.

An include directory specified with the **--sys-include** option is considered a "system" include directory. Warnings are suppressed when processing files found in system include directories.

If the filename has no suffix it will be searched for by appending each of a set of include file suffixes. When searching in a given directory all of the suffixes are tried in that directory before moving on to the next search directory. The default set of suffixes is, no extension and `.stdh`. The default can be overridden using the `--incl-suffixes` command line option. A null file suffix cannot be used unless it is present in the suffix list (that is, the C++ compiler will always attempt to add a suffix from the suffix list when the filename has no suffix).

Example

Suppose that the C++ source file `test.cc` contains the following lines:

```
#include <stdio.h>
#include "myinc.h"
```

You can call the C++ compiler as follows:

```
cparm -Imyinclude test.cc
```

First the C++ compiler looks for the file `stdio.h` in the directory `myinclude` relative to the current directory. If it was not found, the C++ compiler searches in the environment variable `CPARMINC` and then in the default `include` directory.

The C++ compiler now looks for the file `myinc.h`, in the directory where `test.cc` is located. If the file is not there the C++ compiler searches in the directory `myinclude`. If it was still not found, the C++ compiler searches in the environment variable `CPARMINC` and then in the default `include.cpp` and `include` directories.

5.3. C++ Compiler Error Messages

The C++ compiler reports the following types of error messages in the Problems view of Eclipse.

F (Fatal errors)

Catastrophic errors, also called 'fatal errors', indicate problems of such severity that the compilation cannot continue. For example: command-line errors, internal errors, and missing include files. If multiple source files are being compiled, any source files after the current one will not be compiled.

E (Errors)

Errors indicate violations of the syntax or semantic rules of the C++ language. Compilation continues, but object code is not generated.

W (Warnings)

Warnings indicate something valid but questionable. Compilation continues and object code is generated (if no errors are detected). You can control warnings in the **C/C++ Build » Settings » Tool Settings » C/C++ Compiler » Diagnostics** page of the **Project » Properties for** menu (**C++ compiler option** `--no-warnings`).

R (Remarks)

Remarks indicate something that is valid and probably intended, but which a careful programmer may want to check. These diagnostics are not issued by default. Compilation continues and object code is generated (if no errors are detected). To enable remarks, enable the option **Issue remarks on C++ code** in the **C/C++ Build » Settings » Tool Settings » C/C++ Compiler » Diagnostics** page of the **Project » Properties** for menu (**C++ compiler option `--remarks`**).

S (Internal errors)

Internal compiler errors are caused by failed internal consistency checks and should never occur. However, if such a 'SYSTEM' error appears, please report the occurrence to Altium. Please include a small C++ program causing the error.

Message format

By default, diagnostics are written in a form like the following:

```
cparm E0020: ["test.cc" 3] identifier "name" is undefined
```

With the command line option `--error-file=file` you can redirect messages to a file instead of `stderr`.

Note that the message identifies the file and line involved. Long messages are wrapped to additional lines when necessary.

With the option **C/C++ Build » Settings » Tool Settings » Global Options » Treat warnings as errors** (option `--warnings-as-errors`) you can change the severity of warning messages to errors.

With the command line option `--diag` you can see a list of all messages.

For some messages, a list of entities is useful; they are listed following the initial error message:

```
cparm E0308: ["test.cc" 4] more than one instance of overloaded
      function "f" matches the argument list:
      function "f(int)"
      function "f(float)"
      argument types are: (double)
```

In some cases, some additional context information is provided; specifically, such context information is useful when the C++ compiler issues a diagnostic while doing a template instantiation or while generating a constructor, destructor, or assignment operator function. For example:

```
cparm E0265: ["test.cc" 7] "A::A()" is inaccessible
      detected during implicit generation of "B::B()" at line 7
```

Without the context information, it is very hard to figure out what the error refers to.

Termination Messages

The C++ compiler writes sign-off messages to `stderr` (the Problems view in Eclipse) if errors are detected. For example, one of the following forms of message

TASKING VX-toolset for ARM User Guide

`n errors detected in the compilation of "file".`

`1 catastrophic error detected in the compilation of "file".`

`n errors and 1 catastrophic error detected in the compilation of "file".`

is written to indicate the detection of errors in the compilation. No message is written if no errors were detected. The following message

`Error limit reached.`

is written when the count of errors reaches the error limit (see the [option `--error-limit`](#)); compilation is then terminated. The message

`Compilation terminated.`

is written at the end of a compilation that was prematurely terminated because of a catastrophic error. The message

`Compilation aborted`

is written at the end of a compilation that was prematurely terminated because of an internal error. Such an error indicates an internal problem in the compiler. If such an internal error appears, please report the occurrence to Altium. Please include a small C++ program causing the error.

Chapter 6. Using the Assembler

This chapter describes the assembly process and explains how to call the assembler.

The assembler converts hand-written or compiler-generated assembly language programs into machine language, resulting in object files in the ELF/DWARF object format.

The assembler takes the following files for input and output:

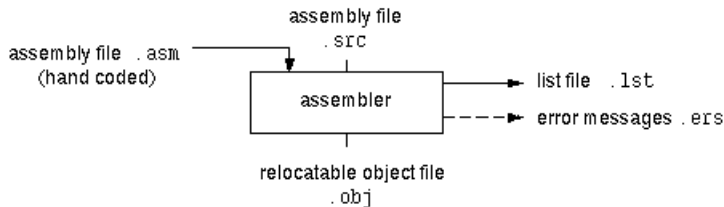

The following information is described:

- The assembly process.
- How to call the assembler and how to use its options. An extensive list of all options and their descriptions is included in [Section 11.4, *Assembler Options*](#).
- How to generate a list file.
- Types of assembler messages.

6.1. Assembly Process

The assembler generates relocatable output files with the extension `.obj`. These files serve as input for the linker.

Phases of the assembly process

- Parsing of the source file: preprocessing of assembler directives and checking of the syntax of instructions
- Generation of the relocatable object file and optionally a list file

The assembler integrates file inclusion and macro facilities. See [Section 3.10, *Macro Operations*](#) for more information.

6.2. Assembler Versions

The TASKING VX-toolset for ARM consists of a set of three assemblers. Depending on the architecture and the selection of the Thumb or mixed ARM/Thumb instruction set Eclipse and the control program select the correct assembler, which results in faster build times.

asarm	supports both ARM and Thumb/Thumb-2 instruction set (full assembler)
asarma	supports ARM instruction set only
asarmt	supports Thumb/Thumb-2 instruction set only

All command line options are the same for all three assemblers.

Also see [control program option --thumb](#).

6.3. Calling the Assembler

The TASKING VX-toolset for ARM under Eclipse uses the TASKING makefile generator and make utility to build your entire project. After you have built your project, the output files are available in a subdirectory of your project directory, depending on the active configuration you have set in the **C/C++ Build » Settings** page of the **Project » Properties for** dialog.

Building a project under Eclipse

You have several ways of building your project:

- Build Individual Project ()

To build individual projects incrementally, select **Project » Build *project***.

- Rebuild Project () This builds every file in the project whether or not a file has been modified since the last build. A rebuild is a clean followed by a build.

1. Select **Project » Clean...**
2. Enable the option **Start a build immediately** and click **OK**.

- Build Automatically. This performs a build of all projects whenever any project file is saved, such as your makefile.

This way of building is not recommended for C/C++ development, but to enable this feature select **Project » Build Automatically** and ensure there is a check mark beside the **Build Automatically** menu item. In order for this option to work, you must also enable option **Build on resource save (Auto build)** on the **Behavior** tab of the **C/C++ Build** page of the **Project » Properties for** dialog.

Select a target processor (core)

Processor options affect the invocation of all tools in the toolset. In Eclipse you need to set them for each configuration. Based on the target processor, the compiler includes a special function register file. This is a regular include file which enables you to use virtual registers that are located in memory.

1. From the **Project** menu, select **Properties for**

The Properties dialog appears.

2. In the left pane, expand **C/C++ Build** and select **Processor**.

In the right pane the Processor page appears.

3. From the **Configuration** list, select a configuration or select [All configurations].
4. From the **Processor selection** list, select a processor.

To access the assembler options

1. From the **Project** menu, select **Properties for**

The Properties dialog appears.

2. In the left pane, expand **C/C++ Build** and select **Settings**.

In the right pane the Settings appear.

3. From the **Configuration** list, select a configuration or select [All configurations].
4. On the Tool Settings tab, select **Assembler**.
5. Select the sub-entries and set the options in the various pages.

Note that the options you enter in the Assembler page are not only used for hand-coded assembly files, but also for the assembly files generated by the compiler.

You can find a detailed description of all assembler options in [Section 11.4, Assembler Options](#).

Invocation syntax on the command line:

```
asarm [ [option]... [file]... ]...
```

The input file must be an assembly source file (.asm or .src).

6.4. How the Assembler Searches Include Files

When you use include files (with the `.INCLUDE` directive), you can specify their location in several ways. The assembler searches the specified locations in the following order:

TASKING VX-toolset for ARM User Guide

1. If the `.INCLUDE` directive contains an absolute path name, the assembler looks for this file. If no path or a relative path is specified, the assembler looks in the same directory as the source file.
2. When the assembler did not find the include file, it looks in the directories that are specified in the **Assembler » Include Paths** page in the **C/C++ Build » Settings » Tool Settings** tab of the Project Properties dialog (equivalent to option `--include-directory (-I)`).
3. When the assembler did not find the include file (because it is not in the specified include directory or because no directory is specified), it looks in the path(s) specified in the environment variable `ASARMINC`.
4. When the assembler still did not find the include file, it finally tries the default include directory relative to the installation directory.

Example

Suppose that the assembly source file `test.asm` contains the following lines:

```
.INCLUDE 'myinc.inc'
```

You can call the assembler as follows:

```
asarm -Imyinclude test.asm
```

First the assembler looks for the file `myinc.asm`, in the directory where `test.asm` is located. If the file is not there the assembler searches in the directory `myinclude`. If it was still not found, the assembler searches in the environment variable `ASARMINC` and then in the default `include` directory.

6.5. Generating a List File

The list file is an additional output file that contains information about the generated code. You can customize the amount and form of information.

If the assembler generates errors or warnings, these are reported in the list file just below the source line that caused the error or warning.

To generate a list file

1. From the **Project** menu, select **Properties for**
The Properties dialog appears.
2. In the left pane, expand **C/C++ Build** and select **Settings**.
In the right pane the Settings appear.
3. On the Tool Settings tab, select **Assembler » List File**.
4. Enable the option **Generate list file**.
5. (Optional) Enable the options to include that information in the list file.

Example on the command line

The following command generates the list file `test.lst`:

```
asarm -l test.asm
```

See [Section 15.1, Assembler List File Format](#), for an explanation of the format of the list file.

6.6. Assembler Error Messages

The assembler reports the following types of error messages in the Problems view of Eclipse.

F (Fatal errors)

After a fatal error the assembler immediately aborts the assembly process.

E (Errors)

Errors are reported, but the assembler continues assembling. No output files are produced unless you have set the [assembler option `--keep-output-files`](#) (the resulting output file may be incomplete).

W (Warnings)

Warning messages do not result into an erroneous assembly output file. They are meant to draw your attention to assumptions of the assembler for a situation which may not be correct. You can control warnings in the **C/C++ Build » Settings » Tool Settings » Assembler » Diagnostics** page of the **Project » Properties for** menu ([assembler option `--no-warnings`](#)).

Display detailed information on diagnostics

1. From the **Window** menu, select **Show View » Other » TASKING » Problems**.

The Problems view is added to the current perspective.

2. In the Problems view right-click on a message.

A popup menu appears.

3. Select **Detailed Diagnostics Info**.

A dialog box appears with additional information.

On the command line you can use the [assembler option `--diag`](#) to see an explanation of a diagnostic message:

```
asarm --diag=[format:]{all | number,...}
```



Chapter 7. Using the Linker

This chapter describes the linking process, how to call the linker and how to control the linker with a script file.

The TASKING linker is a combined linker/locator. The linker phase combines relocatable object files (.obj files, generated by the assembler), and libraries into a single relocatable linker object file (.out). The locator phase assigns absolute addresses to the linker object file and creates an absolute object file which you can load into a target processor. From this point the term linker is used for the combined linker/locator.

The linker can simultaneously link and locate all programs for all cores available on a target board. The target board may be of arbitrary complexity. A simple target board may contain one standard processor with some external memory that executes one task. A complex target board may contain multiple standard processors and DSPs combined with configurable IP-cores loaded in an FPGA. Each core may execute a different program, and external memory may be shared by multiple cores.

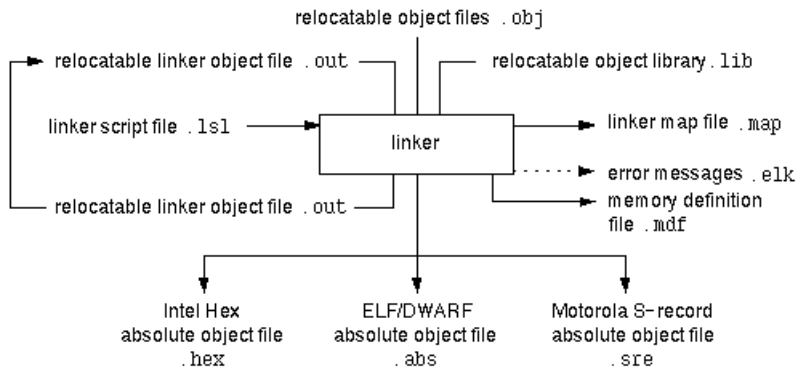
The linker takes the following files for input and output:



This chapter first describes the linking process. Then it describes how to call the linker and how to use its options. An extensive list of all options and their descriptions is included in [Section 11.5, Linker Options](#).

To control the link process, you can write a script for the linker. This chapter shortly describes the purpose and basic principles of the Linker Script Language (LSL) on the basis of an example. A complete description of the LSL is included in Linker Script Language.

7.1. Linking Process

The linker combines and transforms relocatable object files (.obj) into a single absolute object file. This process consists of two phases: the linking phase and the locating phase.

In the first phase the linker combines the supplied relocatable object files and libraries into a single relocatable object file. In the second phase, the linker assigns absolute addresses to the object file so it can actually be loaded into a target.

Terms used in the linking process

Term	Definition
Absolute object file	Object code in which addresses have fixed absolute values, ready to load into a target.
Address	A specification of a location in an address space.
Address space	The set of possible addresses. A core can support multiple spaces, for example in a Harvard architecture the addresses that identify the location of an instruction refer to <i>code</i> space, whereas addresses that identify the location of a data object refer to a <i>data</i> space.
Architecture	A description of the characteristics of a core that are of interest for the linker. This encompasses the address space(s) and the internal bus structure. Given this information the linker can convert logical addresses into physical addresses.
Copy table	A section created by the linker. This section contains data that specifies how the startup code initializes the data sections. For each section the copy table contains the following fields: <ul style="list-style-type: none"> • action: defines whether a section is copied or zeroed • destination: defines the section's address in RAM • source: defines the sections address in ROM • length: defines the size of the section in MAUs of the destination space
Core	An instance of an architecture.
Derivative	The design of a processor. A description of one or more cores including internal memory and any number of buses.
Library	Collection of relocatable object files. Usually each object file in a library contains one symbol definition (for example, a function).
Logical address	An address as encoded in an instruction word, an address generated by a core (CPU).
LSL file	The set of linker script files that are passed to the linker.
MAU	Minimum Addressable Unit. For a given processor the number of bits between an address and the next address. This is not necessarily a byte or a word.
Object code	The binary machine language representation of the C source.
Physical address	An address generated by the memory system.
Processor	An instance of a derivative. Usually implemented as a (custom) chip, but can also be implemented in an FPGA, in which case the derivative can be designed by the developer.
Relocatable object file	Object code in which addresses are represented by symbols and thus relocatable.
Relocation	The process of assigning absolute addresses.

Term	Definition
Relocation information	Information about how the linker must modify the machine code instructions when it relocates addresses.
Section	A group of instructions and/or data objects that occupy a contiguous range of addresses.
Section attributes	Attributes that define how the section should be linked or located.
Target	The hardware board on which an application is executing. A board contains at least one processor. However, a complex target may contain multiple processors and external memory and may be shared between processors.
Unresolved reference	A reference to a symbol for which the linker did not find a definition yet.

7.1.1. Phase 1: Linking

The linker takes one or more relocatable object files and/or libraries as input. A relocatable object file, as generated by the assembler, contains the following information:

- *Header information*: Overall information about the file, such as the code size, name of the source file it was assembled from, and creation date.
- *Object code*: Binary code and data, divided into various named sections. Sections are contiguous chunks of code that have to be placed in specific parts of the memory. The program addresses start at zero for each section in the object file.
- *Symbols*: Some symbols are exported - defined within the file for use in other files. Other symbols are imported - used in the file but not defined (external symbols). Generally these symbols are names of routines or names of data objects.
- *Relocation information*: A list of places with symbolic references that the linker has to replace with actual addresses. When in the code an external symbol (a symbol defined in another file or in a library) is referenced, the assembler does not know the symbol's size and address. Instead, the assembler generates a call to a preliminary relocatable address (usually 0000), while stating the symbol name.
- *Debug information*: Other information about the object code that is used by a debugger. The assembler optionally generates this information and can consist of line numbers, C source code, local symbols and descriptions of data structures.

The linker resolves the external references between the supplied relocatable object files and/or libraries and combines the files into a single relocatable linker object file.

The linker starts its task by scanning all specified relocatable object files and libraries. If the linker encounters an unresolved symbol, it remembers its name and continues scanning. The symbol may be defined elsewhere in the same file, or in one of the other files or libraries that you specified to the linker. If the symbol is defined in a library, the linker extracts the object file with the symbol definition from the library. This way the linker collects all definitions and references of all of the symbols.

Next, the linker combines sections with the same section name and attributes into single sections. The linker also substitutes (external) symbol references by (relocatable) numerical addresses where possible.

TASKING VX-toolset for ARM User Guide

At the end of the linking phase, the linker either writes the results to a file (a single relocatable object file) or keeps the results in memory for further processing during the locating phase.

The resulting file of the linking phase is a single relocatable object file (`.out`). If this file contains unresolved references, you can link this file with other relocatable object files (`.obj`) or libraries (`.lib`) to resolve the remaining unresolved references.

With the linker command line option `--link-only`, you can tell the linker to only perform this linking phase and skip the locating phase. The linker complains if any unresolved references are left.

7.1.2. Phase 2: Locating

In the locating phase, the linker assigns absolute addresses to the object code, placing each section in a specific part of the target memory. The linker also replaces references to symbols by the actual address of those symbols. The resulting file is an absolute object file which you can actually load into a target memory. Optionally, when the resulting file should be loaded into a ROM device the linker creates a so-called copy table section which is used by the startup code to initialize the data sections.

Code modification

When the linker assigns absolute addresses to the object code, it needs to modify this code according to certain rules or *relocation expressions* to reflect the new addresses. These relocation expressions are stored in the relocatable object file. Consider the following snippet of x86 code that moves the contents of variable `a` to variable `b` via the `eax` register:

```
A1 3412 0000 mov a,%eax    (a defined at 0x1234, byte reversed)
A3 0000 0000 mov %eax,b    (b is imported so the instruction refers to
                           0x0000 since its location is unknown)
```

Now assume that the linker links this code so that the section in which `a` is located is relocated by `0x10000` bytes, and `b` turns out to be at `0x9A12`. The linker modifies the code to be:

```
A1 3412 0100 mov a,%eax    (0x10000 added to the address)
A3 129A 0000 mov %eax,b    (0x9A12 patched in for b)
```

These adjustments affect instructions, but keep in mind that any pointers in the data part of a relocatable object file have to be modified as well.

Output formats

The linker can produce its output in different file formats. The default ELF/DWARF format (`.abs`) contains an image of the executable code and data, and can contain additional debug information. The Intel-Hex format (`.hex`) and Motorola S-record format (`.sre`) only contain an image of the executable code and data. You can specify a format with the options `--output (-o)` and `--chip-output (-c)`.

Controlling the linker

Via a so-called *linker script file* you can gain complete control over the linker. The script language is called the *Linker Script Language* (LSL). Using LSL you can define:

- The memory installed in the embedded target system:

To assign locations to code and data sections, the linker must know what memory devices are actually installed in the embedded target system. For each physical memory device the linker must know its start-address, its size, and whether the memory is read-write accessible (RAM) or read-only accessible (ROM).

- How and where code and data should be placed in the physical memory:

Embedded systems can have complex memory systems. If for example on-chip and off-chip memory devices are available, the code and data located in internal memory is typically accessed faster and with dissipating less power. To improve the performance of an application, specific code and data sections should be located in on-chip memory. By writing your own LSL file, you gain full control over the locating process.

- The underlying hardware architecture of the target processor.

To perform its task the linker must have a model of the underlying hardware architecture of the processor you are using. For example the linker must know how to translate an address used within the object file (a logical address) into an offset in a particular memory device (a physical address). In most linkers this model is hard coded in the executable and can not be modified. For the TASKING linker this hardware model is described in the linker script file. This solution is chosen to support configurable cores that are used in system-on-chip designs.

When you want to write your own linker script file, you can use the standard linker script files with architecture descriptions delivered with the product.

See also [Section 7.7, Controlling the Linker with a Script](#).

7.2. Calling the Linker

In Eclipse you can set options specific for the linker. After you have built your project, the output files are available in a subdirectory of your project directory, depending on the active configuration you have set in the **C/C++ Build » Settings** page of the **Project » Properties for** dialog.

Building a project under Eclipse

You have several ways of building your project:

- Build Individual Project ()

To build individual projects incrementally, select **Project » Build project**.

- Rebuild Project () This builds every file in the project whether or not a file has been modified since the last build. A rebuild is a clean followed by a build.

1. Select **Project » Clean...**

2. Enable the option **Start a build immediately** and click **OK**.

TASKING VX-toolset for ARM User Guide

- **Build Automatically.** This performs a build of all projects whenever any project file is saved, such as your makefile.

This way of building is not recommended, but to enable this feature select **Project » Build Automatically** and ensure there is a check mark beside the **Build Automatically** menu item. In order for this option to work, you must also enable option **Build on resource save (Auto build)** on the **Behavior** tab of the **C/C++ Build** page of the **Project » Properties for** dialog.

To access the linker options

1. From the **Project** menu, select **Properties for**
The Properties dialog appears.
2. In the left pane, expand **C/C++ Build** and select **Settings**.
In the right pane the Settings appear.
3. From the **Configuration** list, select a configuration or select [All configurations].
4. On the Tool Settings tab, select **Linker**.
5. Select the sub-entries and set the options in the various pages.

You can find a detailed description of all linker options in [Section 11.5, Linker Options](#).

Invocation syntax on the command line:

```
lkarm [ [option]... [file]... ]...
```

When you are linking multiple files, either relocatable object files (.obj) or libraries (.lib), it is important to specify the files in the right order. This is explained in [Section 7.3, Linking with Libraries](#).

Example:

```
lkarm -darm.lsl test.obj
```

This links and locates the file `test.obj` and generates the file `test.abs`.

7.3. Linking with Libraries

There are two kinds of libraries: system libraries and user libraries.

System library

System libraries are stored in the directories:

```
<ARM installation path>\lib\v6M\le (little-endian variant)  
<ARM installation path>\lib\v6M\be (big-endian variant)  
<ARM installation path>\lib\v7[EM|M|R]\le
```

```
<ARM installation path>\lib\v7[EM|M|R]\be
<ARM installation path>\lib\v7R\be32 (big-endian 32 variant)
```

An overview of the system libraries is given in the following table:

Libraries	Description
carm[s].lib cthumb[s].lib	C libraries for ARM and Thumb instructions respectively Optional letter: s = single precision floating-point (control program option --fp-model=+float)
fparm.lib fpthumb.lib	Floating-point libraries for ARM and Thumb
rtarm.lib rtthumb.lib	Run-time library for ARM and Thumb
pbarm.lib / pbthumb.lib pcarm.lib / pctthumb.lib pctarm.lib / pctthumb.lib pdarm.lib / pdthumb.lib ptarm.lib / ptthumb.lib	Profiling libraries for ARM and Thumb pb = block/function counter pc = call graph pct = call graph and timing pd = dummy pt = function timing
dspthumb[s].lib	CMSIS DSP libraries Optional letter: s = single precision floating-point
cparm[s][x].lib cpthumb[s][x].lib	C++ libraries for ARM and Thumb Optional letter: s = single precision floating-point x = exception handling
stlarmx.lib stlthumbx.lib	STLport C++ libraries (exception handling variants only)

To link the default C (system) libraries

1. From the **Project** menu, select **Properties for**
The Properties dialog appears.
2. In the left pane, expand **C/C++ Build** and select **Settings**.
In the right pane the Settings appear.
3. On the Tool Settings tab, select **Linker » Libraries**.
4. Enable the option **Link default libraries**.

When you want to link system libraries from the command line, you must specify this with the option **--library (-l)**. For example, to specify the system library `carm.lib`, type:

```
lkarm --library=carm test.obj
```

To use the CMSIS DSP library in your Eclipse project

Part of the CMSIS standard is a DSP library. The CMSIS DSP library is included in the TASKING product's `cmsis` folder. The library is also available as a pre-built library file in the `lib` folders for v6M, v7M and v7EM. The libraries are `dsptthumb.lib` (double precision floating point) and `dsptthumbs.lib` (single precision floating point). MIL libraries are present also: `dsptthumb.ma` and `dsptthumbs.ma`.

1. From the **Project** menu, select **Properties for**
The Properties dialog appears.
2. In the left pane, expand **C/C++ Build** and select **Settings**.
In the right pane the Settings appear.
3. On the Tool Settings tab, select **C/C++ Compiler » Include Paths**.
4. Enable the option **Add CMSIS include paths**.
5. On the Tool Settings tab, select **Linker » Libraries**.
6. Enable the option **Link CMSIS DSP library**.

*This passes the option **--dsp-library** of the control program (**ccarm**) for compilation of C/C++ files and for linking. With this option the control program sets the compiler macro `ARM_MATH_CM0`, `ARM_MATH_CM0PLUS`, `ARM_MATH_CM3`, `ARM_MATH_CM4` or `ARM_MATH_CM7`, depending on the selected processor. These macros are required for the CMSIS `arm_math.h` header file to operate correctly. With **--dsp-library** the control program also selects the appropriate library.*

User library

You can create your own libraries. [Section 9.4, Archiver](#) describes how you can use the archiver to create your own library with object modules.

To link user libraries

1. From the **Project** menu, select **Properties for**
The Properties dialog appears.
2. In the left pane, expand **C/C++ Build** and select **Settings**.
In the right pane the Settings appear.
3. On the Tool Settings tab, select **Linker » Libraries**.
4. Add your libraries to the **Libraries** box.

When you want to link user libraries from the command line, you must specify their filenames on the command line:

```
lkarm start.obj mylib.lib
```

If the library resides in a sub-directory, specify that directory with the library name:

```
lkarm start.obj mylibs\mylib.lib
```

If you do not specify a directory, the linker searches the library in the current directory only.

Library order

The order in which libraries appear on the command line is important. By default the linker processes object files and libraries in the order in which they appear at the command line. Therefore, when you use a weak symbol construction, like `printf`, in an object file or your own library, you must position this object/library before the C library.

With the option **--first-library-first** you can tell the linker to scan the libraries from left to right, and extract symbols from the first library where the linker finds it. This can be useful when you want to use newer versions of a library routine:

```
lkarm --first-library-first a.lib test.obj b.lib
```

If the file `test.obj` calls a function which is both present in `a.lib` and `b.lib`, normally the function in `b.lib` would be extracted. With this option the linker first tries to extract the symbol from the first library `a.lib`.

Note that routines in `b.lib` that call other routines that are present in both `a.lib` and `b.lib` are now also resolved from `a.lib`.

7.3.1. How the Linker Searches Libraries

System libraries

You can specify the location of system libraries in several ways. The linker searches the specified locations in the following order:

1. The linker first looks in the **Library search path** that are specified in the **Linker » Libraries** page in the **C/C++ Build » Settings » Tool Settings** tab of the Project Properties dialog (equivalent to the option **--library-directory (-L)**). If you specify the **-L** option without a pathname, the linker stops searching after this step.
2. When the linker did not find the library (because it is not in the specified library directory or because no directory is specified), it looks in the path(s) specified in the environment variable `LIBARM`.
3. When the linker did not find the library, it tries the default `lib` directory relative to the installation directory (or a processor specific sub-directory).

User library

If you use your own library, the linker searches the library in the current directory only.

7.3.2. How the Linker Extracts Objects from Libraries

A library built with the TASKING archiver **ararm** always contains an index part at the beginning of the library. The linker scans this index while searching for unresolved externals. However, to keep the index as small as possible, only the defined symbols of the library members are recorded in this area.

When the linker finds a symbol that matches an unresolved external, the corresponding object file is extracted from the library and is processed. After processing the object file, the remaining library index is searched. If after a complete search of the library unresolved externals are introduced, the library index will be scanned again. After all files and libraries are processed, and there are still unresolved externals and you did not specify the linker option **--no-rescan**, all libraries are rescanned again. This way you do not have to worry about the library order on the command line and the order of the object files in the libraries. However, this rescanning does not work for 'weak symbols'. If you use a weak symbol construction, like `printf`, in an object file or your own library, you must position this object/library before the C library.

The option **--verbose (-v)** shows how libraries have been searched and which objects have been extracted.

Resolving symbols

If you are linking from libraries, only the objects that contain symbols to which you refer, are extracted from the library. This implies that if you invoke the linker like:

```
lkarm mylib.lib
```

nothing is linked and no output file will be produced, because there are no unresolved symbols when the linker searches through `mylib.lib`.

It is possible to force a symbol as external (unresolved symbol) with the option **--extern (-e)**:

```
lkarm --extern=main mylib.lib
```

In this case the linker searches for the symbol `main` in the library and (if found) extracts the object that contains `main`.

If this module contains new unresolved symbols, the linker looks again in `mylib.lib`. This process repeats until no new unresolved symbols are found.

7.4. Incremental Linking

With the TASKING linker it is possible to link incrementally. Incremental linking means that you link some, but not all `.obj` modules to a relocatable object file `.out`. In this case the linker does not perform the locating phase. With the second invocation, you specify both new `.obj` files as the `.out` file you had created with the first invocation.

Incremental linking is only possible on the command line.

```
lkarm -darm.lsl --incremental test1.obj -otest.out
lkarm -darm.lsl test2.obj test.out
```

This links the file `test1.obj` and generates the file `test.out`. This file is used again and linked together with `test2.obj` to create the file `test.abs` (the default name if no output filename is given in the default ELF/DWARF format).

With incremental linking it is normal to have unresolved references in the output file until all `.obj` files are linked and the final `.out` or `.abs` file has been reached. The option `--incremental (-r)` for incremental linking also suppresses warnings and errors because of unresolved symbols.

7.5. Importing Binary Files

With the TASKING linker it is possible to add a binary file to your absolute output file. In an embedded application you usually do not have a file system where you can get your data from.

Add a data object in Eclipse

1. Select **Linker » Data Objects**.

The Data objects box shows the list of object files that are imported.

2. To add a data object, click on the **Add** button in the **Data objects** box.
3. Type or select a binary file (including its path).

On the command line you can add raw data to your application with the linker option `--import-object`.

This makes it possible for example to display images on a device or play audio. The linker puts the raw data from the binary file in a section. The section is aligned on a 4-byte boundary. The section name is derived from the filename, in which dots are replaced by an underscore. So, when importing a file called `my.mp3`, a section with the name `my_mp3` is created. In your application you can refer to the created section by using linker labels.

For example:

```
#include <stdio.h>
extern char _lc_ub_my_mp3; /* linker labels */
extern char _lc_ue_my_mp3;
char* mp3 = &_amp;lc_ub_my_mp3;

void main(void)
{
    int size = &_amp;lc_ue_my_mp3 - &_amp;lc_ub_my_mp3;
    int i;
    for (i=0;i<size;i++)
        putchar(mp3[i]);
}
```

If you want to use the export functionality of Eclipse, the binary file has to be part of your project.

7.6. Linker Optimizations

During the linking and locating phase, the linker looks for opportunities to optimize the object code. Both code size and execution speed can be optimized.

To enable or disable optimizations

1. From the **Project** menu, select **Properties for**
The Properties dialog appears.
2. In the left pane, expand **C/C++ Build** and select **Settings**.
In the right pane the Settings appear.
3. On the Tool Settings tab, select **Linker » Optimization**.
4. Enable one or more optimizations.

You can enable or disable the optimizations described below. The command line option for each optimization is given in brackets.

Delete unreferenced sections (option **-Oc/-OC**)

This optimization removes unused sections from the resulting object file.

First fit decreasing (option **-OI/-OL**)

When the physical memory is fragmented or when address spaces are nested it may be possible that a given application cannot be located although the size of the available physical memory is larger than the sum of the section sizes. Enable the first-fit-decreasing optimization when this occurs and re-link your application.

The linker's default behavior is to place sections in the order that is specified in the LSL file (that is, working from low to high memory addresses or vice versa). This also applies to sections within an unrestricted group. If a memory range is partially filled and a section must be located that is larger than the remainder of this range, then the section and all subsequent sections are placed in a next memory range. As a result of this gaps occur at the end of a memory range.

When the first-fit-decreasing optimization is enabled the linker will first place the largest sections in the smallest memory ranges that can contain the section. Small sections are located last and can likely fit in the remaining gaps.

Compress copy table (option **-Ot/-OT**)

The startup code initializes the application's data areas. The information about which memory addresses should be zeroed and which memory ranges should be copied from ROM to RAM is stored in the copy table.

When this optimization is enabled the linker will try to locate sections in such a way that the copy table is as small as possible thereby reducing the application's ROM image.

Delete duplicate code (option -Ox/-OX)

Delete duplicate constant data (option -Oy/-OY)

These two optimizations remove code and constant data that is defined more than once, from the resulting object file.

Compress ROM sections of copy table items (option -Oz/-OZ)

Reduces the size of the application's ROM image by compressing the ROM image of initialized data sections. At application startup time the ROM image is decompressed and copied to RAM.

When this optimization is enabled the linker will try to locate sections in such a way that the copy table is as small as possible thereby reducing the application's ROM image.

7.7. Controlling the Linker with a Script

With the options on the command line you can control the linker's behavior to a certain degree. From Eclipse it is also possible to determine where your sections will be located, how much memory is available, which sorts of memory are available, and so on. Eclipse passes these locating directions to the linker via a script file. If you want even more control over the locating process you can supply your own script.

The language for the script is called the *Linker Script Language*, or shortly LSL. You can specify the script file to the linker, which reads it and locates your application exactly as defined in the script. If you do not specify your own script file, the linker always reads a standard script file which is supplied with the toolset.

7.7.1. Purpose of the Linker Script Language

The Linker Script Language (LSL) serves three purposes:

1. It provides the linker with a definition of the target's core architecture. This definition is supplied with the toolset.
2. It provides the linker with a specification of the memory attached to the target processor.
3. It provides the linker with information on how your application should be located in memory. This gives you, for example, the possibility to create overlaying sections.

The linker accepts multiple LSL files. You can use the specifications of the core architectures that Altium has supplied in the `include.lsl` directory. Do not change these files.

If you use a different memory layout than described in the LSL file supplied for the target core, you must specify this in a separate LSL file and pass both the LSL file that describes the core architecture and your LSL file that contains the memory specification to the linker. Next you may want to specify how sections should be located and overlaid. You can do this in the same file or in another LSL file.

LSL has its own syntax. In addition, you can use the standard C preprocessor keywords, such as `#include` and `#define`, because the linker sends the script file first to the C preprocessor before it starts interpreting the script.

The complete LSL syntax is described in [Chapter 17, Linker Script Language \(LSL\)](#).

7.7.2. Eclipse and LSL

In Eclipse you can specify the size of the stack and heap; the physical memory attached to the processor; identify that particular address ranges are reserved; and specify which sections are located where in memory. Eclipse translates your input into an LSL file that is stored in the project directory under the name `project_name.lsl` and passes this file to the linker. If you want to learn more about LSL you can inspect the generated file `project_name.lsl`.

To add a generated Linker Script File to your project

1. From the **File** menu, select **File » New » TASKING ARM C/C++ Project**.

The New C/C++ Project wizard appears.

2. Fill in the project settings in each dialog and click **Next >** until the following dialog appears.

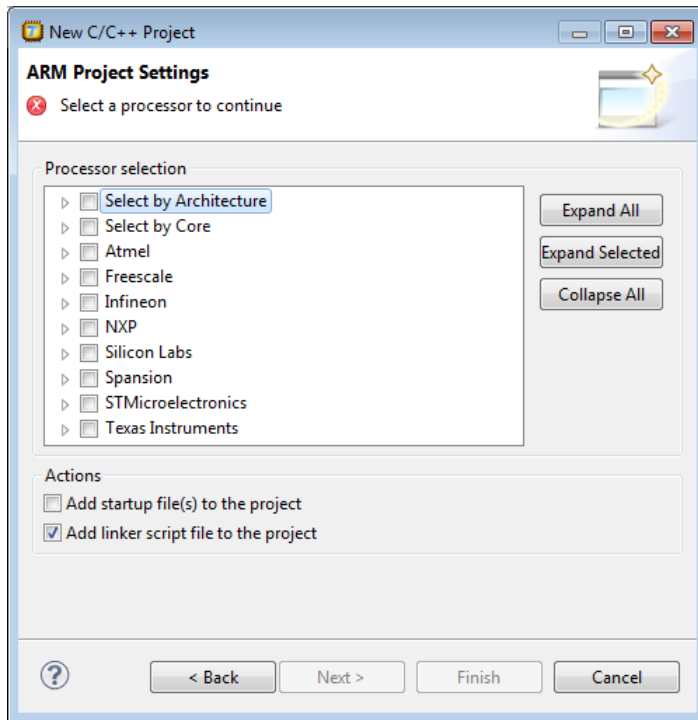

3. Enable the option **Add linker script file to the project** and click **Finish**.

Eclipse creates your project and the file "project_name.lsl" in the project directory.

If you do not add the linker script file here, you can always add it later with **File » New » Linker Script File (LSL)**

To change the Linker Script File in Eclipse

There are two ways of changing the LSL file in Eclipse.

- You can change the LSL file directly in an editor.

- Double-click on the file `project_name.lsl`.

The project LSL file opens in the editor area.

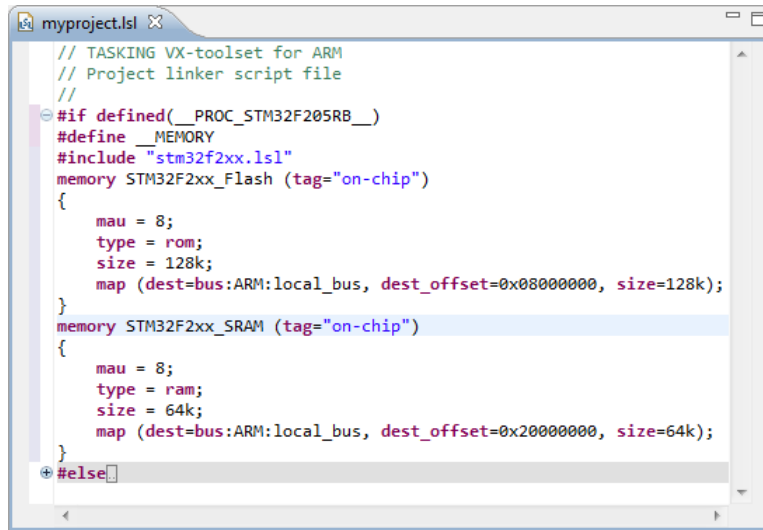

```

myproject.lsl
// TASKING VX-toolset for ARM
// Project linker script file
//
#if defined(__PROC_STM32F205RB__)
#define __MEMORY
#include "stm32f2xx.lsl"
memory STM32F2xx_Flash (tag="on-chip")
{
    mau = 8;
    type = rom;
    size = 128k;
    map (dest=bus:ARM:local_bus, dest_offset=0x08000000, size=128k);
}
memory STM32F2xx_SRAM (tag="on-chip")
{
    mau = 8;
    type = ram;
    size = 64k;
    map (dest=bus:ARM:local_bus, dest_offset=0x20000000, size=64k);
}
#else

```

- You can edit the LSL file directly in the `project_name.lsl` editor.

*A * appears in front of the name of the LSL file to indicate that the file has changes.*

- Click  or select **File » Save** to save the changes.

- You can also make changes to the property pages Memory and Stack/Heap.

- From the **Project** menu, select **Properties for**

The Properties dialog appears.

- In the left pane, expand **C/C++ Build** and select **Memory** or **Stack/Heap**.

In the right pane the corresponding property page appears.

- Make changes to memory and/or stack/heap and click **OK**.

The project LSL file is updated automatically according to the changes you make in the pages.

You can quickly navigate through the LSL file by using the Outline view (**Window » Show View » Outline**).

7.7.3. Structure of a Linker Script File

A script file consists of several definitions. The definitions can appear in any order.

The architecture definition (required)

In essence an *architecture definition* describes how the linker should convert logical addresses into physical addresses for a given type of core. If the core supports multiple address spaces, then for each space the linker must know how to perform this conversion. In this context a physical address is an offset on a given internal or external bus. Additionally the architecture definition contains information about items such as the (hardware) stack and the vector table.

This specification is normally written by Altium. Altium supplies LSL files in the `include.lsl` directory.

The architecture definition of the LSL file should not be changed by you unless you also modify the core's hardware architecture. If the LSL file describes a multi-core system an architecture definition must be available for each different type of core.

The linker uses the architecture name in the LSL file to identify the target. For example, the default library search path can be different for each core architecture.

The derivative definition

The *derivative definition* describes the configuration of the internal (on-chip) bus and memory system. Basically it tells the linker how to convert offsets on the buses specified in the architecture definition into offsets in internal memory. Microcontrollers and DSPs often have internal memory and I/O sub-systems apart from one or more cores. The design of such a chip is called a *derivative*.

When you want to use multiple cores of the same type, you must instantiate the cores in a derivative definition, since the linker automatically instantiates only a single core for an unused architecture.

The processor definition

The *processor definition* describes an instance of a derivative. A processor definition is only needed in a multi-processor embedded system. It allows you to define multiple processors of the same type.

If for a derivative 'A' no processor is defined in the LSL file, the linker automatically creates a processor named 'A' of derivative 'A'. This is why for single-processor applications it is enough to specify the derivative in the LSL file.

The memory and bus definitions (optional)

Memory and bus definitions are used within the context of a derivative definition to specify internal memory and on-chip buses. In the context of a board specification the memory and bus definitions are used to define external (off-chip) memory and buses. Given the above definitions the linker can convert a logical address into an offset into an on-chip or off-chip memory device.

The board specification

The processor definition and memory and bus definitions together form a board specification. LSL provides language constructs to easily describe single-core and heterogeneous or homogeneous multi-core

systems. The board specification describes all characteristics of your target board's system buses, memory devices, I/O sub-systems, and cores that are of interest to the linker. Based on the information provided in the board specification the linker can for each core:

- convert a logical address to an offset within a memory device
- locate sections in physical memory
- maintain an overall view of the used and free physical memory within the whole system while locating

The section layout definition (optional)

The optional section layout definition enables you to exactly control where input sections are located. Features are provided such as: the ability to place sections at a given address, to place sections in a given order, and to overlay code and/or data sections.

Example: Skeleton of a Linker Script File

A linker script file that defines a derivative "X" based on the ARM architecture, its external memory and how sections are located in memory, may have the following skeleton:

```
architecture ARM
{
    // Specification of the ARM core architecture.
    // Written by Altium.
}

derivative X // derivative name is arbitrary
{
    // Specification of the derivative.
    // Written by Altium.
    core ARM // always specify the core
    {
        architecture = ARM;
    }

    bus local_bus // local bus
    {
        // maps to bus "local_bus" in "ARM" core
    }

    // internal memory
}

processor spe // processor name is arbitrary
{
    derivative = X;

    // You can omit this part, except if you use a
    // multi-core system.
}
```

```
memory ext_name
{
    // external memory definition
}

section_layout spe:ARM:linear    // section layout
{
    // section placement statements

    // sections are located in address space 'linear'
    // of core 'ARM' of processor 'spe'
}
```

Overview of LSL files delivered by Altium

Altium supplies the following LSL files in the directory `include.lsl`.

LSL file	Description
<code>arm_arch.lsl</code>	Defines the base architecture (ARM) for all cores.
<code>arm.lsl</code>	It includes the file <code>arm_arch.lsl</code> and contains a default specification of the external memory attached to the target processor.
<code>default.lsl</code>	Default LSL file. This file includes the file <code>arm.lsl</code> or <code>device.lsl</code> if <code>__DEVICE_LSL_FILE</code> is defined.
<code>device.lsl</code>	This file includes a processor specific LSL file based on the selected processor. See control program option --cpu .
<code>processor.lsl</code>	Processor specific LSL file with a specification of the external memory attached to the target processor. It includes the file <code>arm_arch.lsl</code> .
<code>template.lsl</code>	This file is used by Eclipse as a template for the project LSL file. It includes the file <code>device.lsl</code> .

When you select to add a linker script file when you create a project in Eclipse, Eclipse makes a copy of the file `template.lsl` and names it "`project_name.lsl`". On the command line, the linker uses the file `default.lsl`, unless you specify another file with the [linker option --lsl-file \(-d\)](#).

7.7.4. The Architecture Definition

Although you will probably not need to write an architecture definition (unless you are building your own processor core) it helps to understand the Linker Script Language and how the definitions are interrelated.

Within an *architecture definition* the characteristics of a target processor core that are important for the linking process are defined. These include:

- space definitions: the logical address spaces and their properties
- bus definitions: the I/O buses of the core architecture

- mappings: the address translations between logical address spaces, the connections between logical address spaces and buses and the address translations between buses

Address spaces

A logical address space is a memory range for which the core has a separate way to encode an address into instructions. Most microcontrollers and DSPs support multiple address spaces. For example, separate spaces for code and data. Normally, the size of an address space is 2^N , with N the number of bits used to encode the addresses.

The relation of an address space with another address space can be one of the following:

- one space is a subset of the other. These are often used for "small" absolute or relative addressing.
- the addresses in the two address spaces represent different locations so they do not overlap. This means the core must have separate sets of address lines for the address spaces. For example, in Harvard architectures we can identify at least a code and a data memory space.

Address spaces (even nested) can have different minimal addressable units (MAU), alignment restrictions, and page sizes. All address spaces have a number that identifies the logical space (id). The following table lists the different address spaces for the architecture ARM as defined in `arm_arch.lsl`.

Space	Id	MAU	Description
linear	1	8	Linear address space.

The ARM architecture in LSL notation

The best way to write the architecture definition, is to start with a drawing. The following figure shows a part of the ARM architecture:

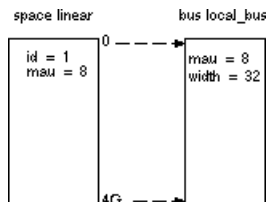

The figure shows one address space called `linear`. The address space has attributes like a number that identifies the logical space (id), a MAU and an alignment. In LSL notation the definition of this address space looks as follows:

```
space linear
{
    id = 1;
    mau = 8;

    map (size=4G, dest=bus:local_bus);
}
```

The keyword `map` corresponds with the arrows in the drawing. You can map:

TASKING VX-toolset for ARM User Guide

- address space => address space (not shown in the drawing)
- address space => bus
- memory => bus (not shown in the drawing)
- bus => bus (not shown in the drawing)

Next the internal buses, named `local_bus` must be defined in LSL:

```
bus local_bus
{
    mau = 8;
    width = 32; // there are 32 data lines on the bus
}
```

This completes the LSL code in the architecture definition. Note that all code above goes into the architecture definition, thus between:

```
architecture ARM
{
    // All code above goes here.
}
```

7.7.5. The Derivative Definition

Although you will probably not need to write a derivative definition (unless you are using multiple cores that both access the same memory device) it helps to understand the Linker Script Language and how the definitions are interrelated.

A *derivative* is the design of a processor, as implemented on a chip (or FPGA). It comprises one or more cores and on-chip memory. The derivative definition includes:

- core definition: an instance of a core architecture
- bus definition: the I/O buses of the core architecture
- memory definitions: internal (or on-chip) memory

Core

Each derivative must have at least one core and each core must have a specification of its core architecture. This core architecture must be defined somewhere in the LSL file(s).

```
core ARM
{
    architecture = ARM;
}
```

Bus

Each derivative can contain a bus definition for connecting external memory. In this example, the bus `local_bus` maps to the bus `local_bus` defined in the architecture definition of core ARM:

```
bus local_bus
{
    mau = 8;
    width = 32;
    map (dest=bus:ARM:local_bus, dest_offset=0, size=4G);
}
```

Memory

Memory is usually described in a separate memory definition, but you can specify on-chip memory for a derivative. For example:

```
memory internal_code_rom
{
    mau = 8;
    type = rom;
    size = 2k;
    map( dest=bus:ARM:local_bus, size = 2k, dest_offset = 0x00100000);
    // src_offset is zero by default
}
```

This completes the LSL code in the derivative definition. Note that all code above goes into the derivative definition, thus between:

```
derivative X // name of derivative
{
    // All code above goes here
}
```

7.7.6. The Processor Definition

The processor definition is only needed when you write an LSL file for a multi-processor embedded system. The processor definition explicitly instantiates a derivative, allowing multiple processors of the same type.

```
processor name
{
    derivative = derivative_name;
}
```

If no processor definition is available that instantiates a derivative, a processor is created with the same name as the derivative.

7.7.7. The Memory Definition

Once the core architecture is defined in LSL, you may want to extend the processor with external (or off-chip) memory. You need to specify the location and size of the physical external memory devices in the target system.

The principle is the same as defining the core's architecture but now you need to fill the memory definition:

```
memory name
{
    // memory definitions
}
```

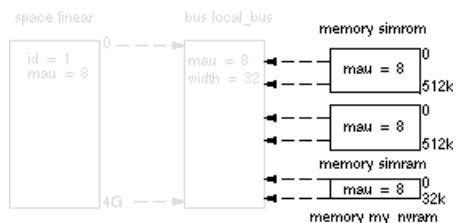

Suppose your embedded system has 512kB of external ROM, named `simrom`, 512kB of external RAM, named `simram` and 32kB of external NVRAM, named `my_nvram` (see figure above.) All memories are connected to the bus `local_bus`. In LSL this looks like follows:

```
memory simrom
{
    mau = 8;
    type = rom;
    size = 512k;
    map ( size = 512k, dest_offset=0, dest=bus:X:local_bus);
}

memory simram
{
    mau = 8;
    type = ram;
    size = 512k;
    map ( size = 512k, dest_offset=512k, dest=bus:X:local_bus);
}

memory my_nvram
{
    mau = 8;
    size = 32k;
    type = ram;
    map ( size = 32k, dest_offset=1M, dest=bus:X:local_bus);
}
```

If you use a different memory layout than described in the LSL file supplied for the target core, you can specify this in Eclipse or you can specify this in a separate LSL file and pass both the LSL file that describes the core architecture and your LSL file that contains the memory specification to the linker.

To add memory using Eclipse

1. From the **Project** menu, select **Properties for**

The Properties dialog appears.

2. In the left pane, expand **C/C++ Build** and select **Memory**.

In the right pane the Memory page appears.

3. Open the **Memory** tab and click on the **Add...** button.

The Add new memory dialog appears.

4. Enter the memory name (for example `my_nvr`), type (for example `nvr`) and size.

5. Click on the **Add...** button.

The Add new mapping dialog appears.

6. You have to specify at least one mapping. Enter the mapping name (optional), address, size and destination and click **OK**.

The new mapping is added to the list of mappings.

7. Click **OK**.

The new memory is added to the list of memories (user memory).

8. Click **OK** to close the Properties dialog.

The updated settings are stored in the project LSL file.

If you make changes to the on-chip memory as defined in the architecture LSL file, the memory is copied to your project LSL file and the line `#define __MEMORY` is added. If you remove all the on-chip memory from your project LSL file, also make sure you remove this define.

7.7.8. The Section Layout Definition: Locating Sections

Once you have defined the internal core architecture and optional memory, you can actually define where your application must be located in the physical memory.

During compilation, the compiler divides the application into sections. Sections have a name, an indication (section type) in which address space it should be located and attributes like writable or read-only.

In the section layout definition you can exactly define how input sections are placed in address spaces, relative to each other, and what their absolute run-time and load-time addresses will be.

Example: section propagation through the toolset

To illustrate section placement, the following example of a C program (`bat.c`) is used. The program saves the number of times it has been executed in battery back-upped memory, and prints the number.

```
#define BATTERY_BACKUP_TAG 0xa5f0
#include <stdio.h>

int uninitialized_data;
int initialized_data = 1;
#pragma section "non_volatile"
int battery_backup_tag;
int battery_backup_invok;
#pragma endsection

void main (void)
{
    if (battery_backup_tag != BATTERY_BACKUP_TAG )
    {
        // battery back-upped memory area contains invalid data
        // initialize the memory
        battery_backup_tag = BATTERY_BACKUP_TAG;
        battery_backup_invok = 0;
    }
    printf( "This application has been invoked %d times\n",
           battery_backup_invok++);
}
```

The compiler assigns names and attributes to sections. With the `#pragma section` and `#pragma endsection` the compiler's default section naming convention is overruled and a section with the name `non_volatile` appended is defined. In this section the battery back-upped data is stored.

As a result of the `#pragma section "non_volatile"`, the data objects between the pragma pair are placed in a section with the name `".bss.non_volatile"`. Note that `".bss"` sections are cleared at startup. However, battery back-upped sections should not be cleared and therefore we will change this section attribute using the LSL.

Section placement

The number of invocations of the example program should be saved in non-volatile (battery back-upped) memory. This is the memory `my_nvram` from the example in [Section 7.7.7, *The Memory Definition*](#).

To control the locating of sections, you need to write one or more section definitions in the LSL file. At least one for each address space where you want to change the default behavior of the linker. In our example, we need to locate sections in the address space `linear`:

```
section_layout ::linear
{
    // Section placement statements
}
```

To locate sections, you must create a group in which you select sections from your program. For the battery back-up example, we need to define one group, which contains the section `.bss.non_volatile`. All other sections are located using the defaults specified in the architecture definition. Section `.bss.non_volatile` should be placed in non-volatile ram. To achieve this, the run address refers to our non-volatile memory called `my_nvram`. Furthermore, the section should not be cleared and therefore the attribute `s` (scratch) is assigned to the group:

```
group ( ordered, run_addr = mem:my_nvram, attributes = rws )
{
    select ".bss.non_volatile";
}
```

This completes the LSL file for the sample architecture and sample program. You can now invoke the linker with this file and the sample program to obtain an application that works for this architecture.

For a complete description of the Linker Script Language, refer to [Chapter 17, Linker Script Language \(LSL\)](#).

7.8. Linker Labels

The linker creates labels that you can use to refer to from within the application software. Some of these labels are real labels at the beginning or the end of a section. Other labels have a second function, these labels are used to address generated data in the locating phase. The data is only generated if the label is used.

Linker labels are labels starting with `_lc_`. The linker assigns addresses to the following labels when they are referenced:

Label	Description
<code>_lc_ub_name</code> <code>_lc_b_name</code>	Begin of section <i>name</i> . Also used to mark the begin of the stack or heap or copy table.
<code>_lc_ue_name</code> <code>_lc_e_name</code>	End of section <i>name</i> . Also used to mark the end of the stack or heap.
<code>_lc_cb_name</code>	Start address of an overlay section in ROM.
<code>_lc_ce_name</code>	End address of an overlay section in ROM.
<code>_lc_gb_name</code>	Begin of group <i>name</i> . This label appears in the output file even if no reference to the label exists in the input file.
<code>_lc_ge_name</code>	End of group <i>name</i> . This label appears in the output file even if no reference to the label exists in the input file.

The linker only allocates space for the stack and/or heap when a reference to either of the section labels exists in one of the input object files.

If you want to use linker labels in your C source for sections that have a dot (.) in the name, you have to replace all dots by underscores.

Example: refer to a label with section name with dots from C

Suppose a section has the name `.text`. When you want to refer to the begin of this section you have to replace all dots in the section name by underscores:

```
#include <stdio.h>
extern char _lc_ub__text[];

void main(void)
{
    printf("The function main is located at %p\n",
           _lc_ub__text);
}
```

Example: refer to the stack

Suppose in an LSL file a stack section is defined with the name "stack" (with the keyword `stack`). You can refer to the begin and end of the stack from your C source as follows:

```
#include <stdio.h>
extern char _lc_ub_stack[];
extern char _lc_ue_stack[];
void main()
{
    printf( "Size of stack is %d\n",
           _lc_ub_stack - _lc_ue_stack );
    /* stack grows from high to low */
}
```

From assembly you can refer to the end of the stack with:

```
.extern _lc_ue_stack    ; end of user stack
```

7.9. Generating a Map File

The map file is an additional output file that contains information about the location of sections and symbols. You can customize the type of information that should be included in the map file.

To generate a map file

1. From the **Project** menu, select **Properties for**
The Properties dialog appears.
2. In the left pane, expand **C/C++ Build** and select **Settings**.

In the right pane the Settings appear.

3. On the Tool Settings tab, select **Linker » Map File**.
4. Enable the option **Generate XML map file format (.mapxml) for map file viewer**.
5. (Optional) Enable the option **Generate map file (.map)**.
6. (Optional) Enable the options to include that information in the map file.

Example on the command line

The following command generates the map file `test.map`:

```
lkarm --map-file test.obj
```

With this command the map file `test.map` is created.

See [Section 15.2, Linker Map File Format](#), for an explanation of the format of the map file.

7.10. Linker Error Messages

The linker reports the following types of error messages in the Problems view of Eclipse.

F (Fatal errors)

After a fatal error the linker immediately aborts the link/locate process.

E (Errors)

Errors are reported, but the linker continues linking and locating. No output files are produced unless you have set the linker option `--keep-output-files`.

W (Warnings)

Warning messages do not result into an erroneous output file. They are meant to draw your attention to assumptions of the linker for a situation which may not be correct. You can control warnings in the **C/C++ Build » Settings » Tool Settings » Linker » Diagnostics** page of the **Project » Properties for** menu (linker option `--no-warnings`).

I (Information)

Verbose information messages do not indicate an error but tell something about a process or the state of the linker. To see verbose information, use the linker option `--verbose`.

S (System errors)

System errors occur when internal consistency checks fail and should never occur. When you still receive the system error message

S6##: *message*

please report the error number and as many details as possible about the context in which the error occurred.

Display detailed information on diagnostics

1. From the **Window** menu, select **Show View » Other » TASKING » Problems**.

The Problems view is added to the current perspective.

2. In the Problems view right-click on a message.

A popup menu appears.

3. Select **Detailed Diagnostics Info**.

A dialog box appears with additional information.

On the command line you can use the [linker option --diag](#) to see an explanation of a diagnostic message:

```
lkarm --diag=[format:]{all | number, ... }
```

Chapter 8. Run-time Environment

This chapter describes the startup code used by the TASKING VX-toolset for ARM C Compiler, the vector table, the stack layout and the heap.

8.1. Startup Code

You need the run-time startup code to build an executable application. The default startup code consists of the following components:

- *Initialization code.* This code is executed when the program is initiated and before the function `main()` is called.
- *Exit code.* This controls the close down of the application after the program's main function terminates.

The startup code is part of the C library, and the source is present in the file `cstart_v5.c` (ARM and Thumb), or `cstart.c` (Thumb2 specific) in the directory `lib\src`. This code is generic code. It uses linker generated symbols which you can give target specific or application specific values. These symbols are defined in the linker script file (`include.lsl\arm_arch.lsl`) and you can specify their values in Eclipse or on the command line with linker option `--define`. If the default run-time startup code does not match your configuration, you need to make a copy of the startup file, modify it and add it to your project. A typical example for doing this is when `main()` has arguments, typically `argc/argv`. In this case `cstart` needs to be recompiled with the macro `__USE_ARGC_ARGV` set. When necessary you can use the macro `__ARGCV_BUFSIZE` to define the size of the buffer used to pass arguments to `main()`.

The entry point of the startup code (reset handler) is label `Reset_Handler`. This global label should not be removed, since the linker uses it in the linker script file. It is also used as the default start address of the application.

Initialization code

The following initialization actions are executed before the application starts:

- Load the 'real' program address. This assures that the reset handler is immune for any ROM/RAM re-mapping.
- Initialize the stack pointers for each processor mode. The stack pointers are loaded in memory by the stack address located at a linker generate symbol (for example `_lc_ub_stack`). These symbols are defined in the linker script file. See [Section 8.4, *Stack and Heap*](#), for detailed information on the stack.
- Call a user function which initializes hardware. The startup code calls the function `SystemInit`. This function has an empty implementation in the C library, which you should overrule if certain hardware initializations, such as ROM/RAM re-mapping or MMU configuration, are required before calling the main application.
- Copy initialized sections from ROM to RAM, using a linker generated table (also known as the 'copy table') and clear uninitialized data sections in RAM.

TASKING VX-toolset for ARM User Guide

- Switch to the user-defined application mode as defined through the symbol `__APPLICATION_MODE__` in the LSL file. This symbol is used to set the value of the CPSR status register before calling the function `main`.
- Initialize profiling if profiling is enabled. For an extensive description of profiling refer to [Chapter 13, Profiling](#).
- Initialize the `argc` and `argv` arguments.
- Call the entry point of your application with a call to function `main()`.

Exit code

When the C application 'returns', which is not likely to happen in an embedded environment, the program ends with a call to the library function `exit()`.

Macro preprocessor symbols

A number of macro preprocessor symbols are used in the startup code. These are enabled when you use a particular option or you can enable or disable them using the [assembler option `--define`](#) with the following syntax:

```
--define=symbol[=value]
```

In the startup file (`cstart_v5.c` and `cstart.c`) the following macro preprocessor symbols are used:

Define	Description
<code>__PROF_ENABLE__</code>	If defined, initialize profiling.
<code>__POSIX__</code>	If defined, call <code>posix_main</code> instead of <code>main</code> .
<code>__USE_ARGC_ARGV</code>	If defined, pass arguments to <code>main</code> : <code>int main(int argc, char *argv[])</code> .
<code>__ARGCV_BUFSIZE</code>	Define buffer size for <code>argv</code> . (default: 256 bytes)

8.2. Reset Handler and Vector Table

Reset handler

As explained in the previous section the entry point of the startup code (reset handler) is label `Reset_Handler`. The reset handler can have a fixed ROM address (run address). If the reset handler is called from the vector table, you do not need to specify a fixed address. In this case the linker determines the address and patches the vector table. There are however situations where you have to specify a fixed ROM address:

- If `Reset_Handler` is the entry point upon reset. Typically you would set the ROM address to the address which is mapped at address `0x00000000`. Your initialization code remaps this address during startup. Note that the reset handler in the run-time library is immune to this remapping because the first instruction in the startup code sets the program counter to the actual ROM address.

- When the reset handler is called from the vector table with a branch instruction (`B Reset_Handler`) and the linker has located the reset handler at an address that is out-of-range of the branch instruction. When you specify a fixed ROM address you can make sure that the reset handler can be called from the vector table. Note however that you can prevent out-of-range branches by using a position independent vector table, which loads the handler addresses into the program counter by means of a PC-relative load from a literal pool.

Reset handler on fixed ROM address (all architectures)

To force the reset handler on a fixed ROM address, you need to define the symbol `__START`. This symbol is used in the linker script file `arm_arch.lsl`. By default, `__START` is not defined.

To define a symbol for the linker script file

1. From the **Project** menu, select **Properties for**

The Properties dialog appears.

2. In the left pane, expand **C/C++ Build** and select **Settings**.

In the right pane the Settings appear.

3. Select **Linker » Script File**.

The Defined symbols box shows the symbols that are currently defined.

4. To define a new symbol, click on the **Add** button in the **Defined symbols** box.

5. Type the symbol definition (for example, `__START=0x0`).

The following table contains an overview of the defines you can set. The defines are used in `arm_arch.lsl`.

Define	Description
<code>__START</code>	Reset handler ROM address
<code>__PROCESSOR_MODE</code>	Main application execution mode. Default value is 0x1F (SYS mode).
<code>__IRQ_BIT</code>	If 0, IRQ interrupts are enabled. The default value is 0x80 (IRQ disabled).
<code>__FIQ_BIT</code>	If 0, FIQ interrupts are enabled. The default value is 0x40 (FIQ disabled).
<code>__NO_AUTO_VECTORS</code>	If defined, the vector table will not be generated. Define this macro when you do not want to generate a vector table automatically.
<code>__NO_DEFAULT_AUTO_VECTORS</code>	If defined, the vector table will not be generated. Define this macro when you define your own vectors.
<code>__NR_OF_VECTORS</code>	Number of vectors (default 48).
<code>__SET_VTOR_BIT29</code>	Define this macro if bit 29 of the VTOR SFR indicates that the vector table is in RAM.

Define	Description
__PIC_VECTORS	If defined, position independent vectors are used.
__FIQ_HANDLER_INLINE	If defined, the FIQ handler is located directly at the FIQ vector (position dependent vector table only).
__VECTOR_TABLE_ROM_ADDR	Address of the vector table in ROM (default 0x00000000).
__VECTOR_TABLE_RAM_ADDR	Address of the copy of the vector table in RAM (default 0x00000000).
__VECTOR_TABLE_RAM_COPY	If defined, the linker provides copy address symbols so that the startup code can copy the vector table from ROM to RAM.
__MTB_SIZE	Size of the Micro Trace Buffer (MTB). This allows tracing on Cortex-M0+ devices that support MTB. To use this debugging facility, define this macro to a value that is a power of 2 and at least 32.

Main application execution mode (all architectures except M-profile)

With the symbol `__PROCESSOR_MODE` you can define the execution mode in which the processor should run when your application's main program is called. Based on this setting, together with the interrupt status (FIQ interrupts enabled/disabled, IRQ interrupts enabled/disabled), the linker will generate a symbol (`__APPLICATION_MODE_`) which value is used in the startup code in the run-time library to set the value of the CPSR status register before calling your main function. Available values:

Value	Description
0x10	USR mode
0x11	FIQ mode
0x12	IRQ mode
0x13	SVC mode
0x17	ABT mode
0x1B	UND mode
0x1F	SYS mode (default)

Interrupt Status (all architectures except M-profile)

It is common use to start with interrupts disabled (`__IRQ_BIT=0x80` and `__FIQ_BIT=0x40`) and enable interrupt during run-time after installing all exception handlers and initializing all peripherals. To enable interrupts during run-time, use the `__setcpsr()` intrinsic:

```
__setcpsr (0x00, 0x80); /* Enable IRQ interrupts */
__setcpsr (0x00, 0x40); /* Enable FIQ interrupts */
```

If you want to start with interrupts enabled, set the define the symbols `__IRQ_BIT=0` and/or `__FIQ_BIT=0`.

Vector table

By default the linker can generate a vector table, unless you define the symbol `__NO_AUTO_VECTORS` or `__NO_DEFAULT_AUTO_VECTORS`.

The linker will look for specific symbols designating the start of a handler function. These symbols are generated by the compiler when one of the following function qualifiers is used:

Function type qualifier	Vector symbol
<code>__interrupt_und</code>	<code>_vector_1</code>
<code>__interrupt_svc</code>	<code>_vector_2 (*)</code>
<code>__interrupt_iabt</code>	<code>_vector_3</code>
<code>__interrupt_dabt</code>	<code>_vector_4</code>
<code>__interrupt_irq</code>	<code>_vector_6</code>
<code>__interrupt_fiq</code>	<code>_vector_7</code>
<code>__interrupt(n)</code>	<code>_vector_n</code>

(*) For M-profile architecture the `__interrupt_swi` qualifier is mapped to `_vector_11`. Function qualifier `__interrupt_swi` is equal to `__interrupt_svc`.

Note that the reset handler is designated by the symbol `Reset_Handler` instead of `_vector_0`. The fifth vector, with symbol `_vector_5` is reserved. You should use the same vector symbols in hand-coded assembly handlers. You may first want to generate an idle handler in C with the compiler and then use the result as a starting point for your assembly implementation. If the linker does not find the symbol for a handler, it will generate a loop for the corresponding vector, i.e. a jump to itself.

Note that if you have more than one handler for the same exception, for example for different IRQ's or for different run-time phases of your application, and you are using the `__interrupt_type` function qualifier of the compiler, you will need to specify the `__novector` attribute in order to prevent the compiler from generating the `_vector_nr` symbol multiple times, as this would lead to a link error.

Vector table size (M-profile architectures)

The vector table size for M-profile architectures is calculated as 4 times the number of vectors. The default number of vectors is 48, but you can specify another value by defining the symbol `__NR_OF_VECTORS`.

Vector table versions (all architectures except M-profile)

You can select between two versions of the vector table: position dependent or position independent.

The *position dependent* table contains branch instructions to the handlers. The handlers must be located in-range of the branch instructions. The size of the table is 32 bytes. This is the default.

The *position independent* table contains PC-relative load instructions of the PC. The handler addresses are in a literal pool (data pocket) following the vector table. There are no range restrictions. The size of the table and pool together is 64 bytes.

A position independent table is recommended if the table is copied from ROM to RAM at run-time or if the ROM table is re-mapped to address 0x00000000 after startup.

To select a position independent vector table, define the symbol `__PIC_VECTORS`.

FIQ handler at FIQ vector (all architectures except M-profile)

If you selected a position dependent vector table (this is the default), it is possible to locate the FIQ handler directly at the FIQ vector, since the FIQ vector is the last vector in the table. To do this, define the symbol `__FIQ_HANDLER_INLINE`. Doing so saves a branch instruction when servicing a fast interrupt. The generated vector table or the space reserved for the table will be 28 bytes instead of 32.

This option is not available for a position independent vector table. Note that you need to use the `__at()` attribute to specify the actual position of the FIQ handler.

Vector table ROM address (all architectures)

The ROM address of the vector table is usually address 0x00000000. You have to specify an address if the vector table will be copied from ROM to RAM (address 0x00000000 is mapped to RAM) or if the hardware uses high vectors at address 0xFFFF0000. If you forced the reset handler on address 0x00000000 then you also have to specify a vector table ROM address to prevent overlapping address ranges.

By default, the symbol `__VECTOR_TABLE_ROM_ADDR` is defined as 0x00000000.

Vector table RAM address (all architectures except M-profile)

With the define `__VECTOR_TABLE_RAM_ADDR` you can set the address in RAM of the copy of the vector table (default 0x00000000).

Copy of vector table in RAM (all architectures except M-profile)

If you define the symbol `__VECTOR_TABLE_RAM_COPY`, the linker will provide copy address symbols that will be used by the startup code to copy the vector table from ROM to RAM.

8.3. CMSIS Support

The interrupt vector table, required for CMSIS, is defined in device specific LSL files. These LSL files are available in Eclipse (and can be updated by the Eclipse update feature) or can be downloaded as a vendor support archive from the TASKING website (www.tasking.com).

Device LSL files are similarly named as the CMSIS header files. For example when you use `stm32f10x.h` the LSL file `stm32f10x.lsl` is available. The device LSL files include the file `arm_arch.lsl`. You can control the allocated amount of flash and SRAM by using defines for the linker. The names of these defines vary per device.

The following table contains an overview of the defines you can set.

Vector table defines

Define	Description
__NO_DEFAULT_AUTO_VECTORS	If defined, the default vector table will not be generated.
__CMSIS_VECTORS	If defined, the CMSIS vector table will be generated.
__NR_OF_VECTORS	Number of vectors.
__COPY_VECTOR_TABLE	If defined, the vector table is copied from ROM to RAM at startup.
__VECTOR_TABLE_ROM_ADDR	Address of the vector table in ROM.
__VECTOR_TABLE_RAM_ADDR	Address of the copy of the vector table in RAM.
__VECTOR_TABLE_RAM_COPY	If defined, the linker provides copy address symbols so that the startup code can copy the vector table from ROM to RAM.

Memory defines

Define	Description
__ROM_SIZE	Size of ROM memory to be allocated.
__RAM_SIZE	Size of RAM memory to be allocated.
__FLASH_SIZE	Size of the flash memory to be allocated.
__SRAM_SIZE	Size of the SRAM memory to be allocated.
__CPU_SRAM_SIZE	Size of the SRAM memory to be allocated.
__AHB_SRAM0_SIZE	Size of the AHB SRAM bank 0 memory. The memory is not allocated if this macro is not defined.
__AHB_SRAM1_SIZE	Size of the AHB SRAM bank 1 memory. The memory is not allocated if this macro is not defined.

An example of the invocation of the linker (using the control program):

```
ccarm -CARMv7M -d"vendor_support_dir\include.lsl\stm32f10x.lsl"
-wl-D__FLASH_SIZE=128k -wl-D__SRAM_SIZE=20k file.obj
```

When you create a new project in Eclipse the LSL template file will be copied to the project. Eclipse will pass device specific macro definitions to the linker, depending on the device selected in the **Project » Properties for » C/C++ Build » Processor** properties page. This way the project LSL file will include the appropriate device LSL file and memories are mapped as required for the selected device.

8.4. Stack and Heap

The stack is used for local automatic variables and function parameters. The following diagram shows the structure of a stack frame.

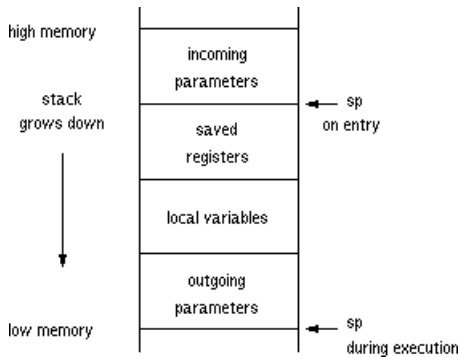

All ARM architectures, except for M-profile architectures, have separate stack pointers for each processor mode. M-profile architectures have one stack pointer. These stack pointers should be initialized at run-time. This is taken care of by the startup code in the run-time library, by means of linker-generated symbols defined in the LSL file. See [Section 8.1, Startup Code](#), for a list of these symbols.

You can define the values of these symbols in Eclipse as follows.

1. From the **Project** menu, select **Properties for**
The Properties dialog appears.
2. In the left pane, expand **C/C++ Build** and select **Stack/Heap**.
In the right pane the Stack/Heap property page appears.

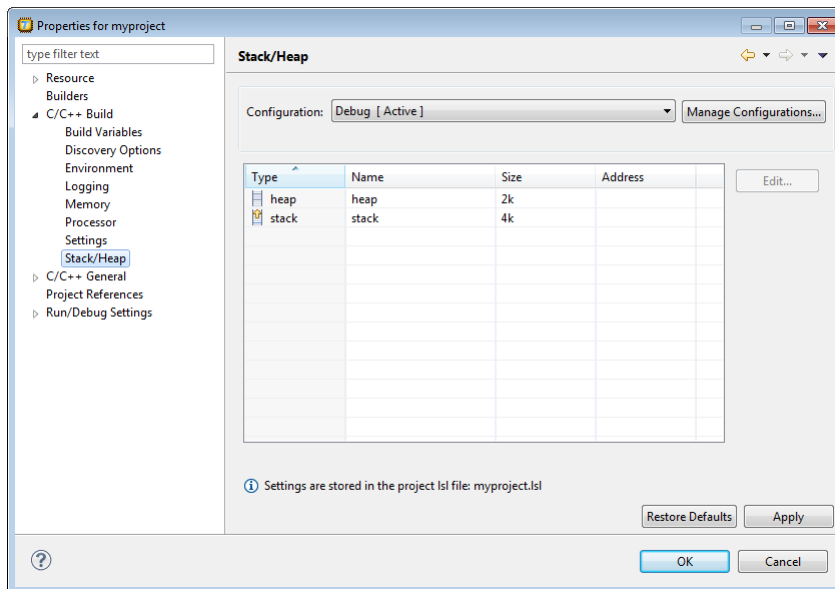

3. Make your changes and click **OK**.

The project LSL file is updated automatically according to the changes you make.

You can specify the size and location of the stacks.

The stack size is defined in the linker script file (`arm_arch.lsl` in directory `include.lsl`) with macros:

Define	Description
<code>__STACK</code>	Minimum size of the stack.
<code>__STACK_ABT</code>	Abort mode stack size. (*)
<code>__STACK_FIQ</code>	FIQ mode stack size. (*)
<code>__STACK_IRQ</code>	IRQ mode stack size. (*)
<code>__STACK_SVC</code>	Supervisor mode stack size. (*)
<code>__STACK_UND</code>	Undefined mode stack size. (*)
<code>__STACK_FIXED</code>	Define this macro if you do not want to let the stack section grow to the maximum available memory.
<code>__STACKADDR</code>	Start address of the stack. If not defined the stack will be located freely.
<code>__STACK_THREADS</code>	Number of threads used to calculate the estimated stack usage which is listed in the map file.

(*) The defines marked with a * are not used for M-profile architectures.

Heap allocation

The heap is only needed when you use one or more of the dynamic memory management library functions: `malloc()`, `calloc()`, `free()` and `realloc()`. The heap is a reserved area in memory. Only if you use one of the memory allocation functions listed above, the linker automatically allocates a heap, as specified in the linker script file with the keyword `heap`.

A special section called `heap` is used for the allocation of the heap area. The size of the heap is defined in the linker script file (`arm_arch.lsl` in directory `include.lsl`) with the macro `__HEAP`, which results in a section called `heap`. The linker defined labels `_lc_ub_heap` and `_lc_ue_heap` (begin and end of heap) are used by the library function `sbrk()`, which is called by `malloc()` when memory is needed from the heap.

The following heap macros are used in `arm_arch.lsl`:

Define	Description
<code>__HEAP</code>	Size of heap.
<code>__HEAP_FIXED</code>	Defined if you do not expand the heap if space is left.
<code>__HEAPADDR</code>	Heap start address.

Chapter 9. Using the Utilities

The TASKING VX-toolset for ARM comes with a number of utilities:

- ccarm** A control program. The control program invokes all tools in the toolset and lets you quickly generate an absolute object file from C and/or assembly source input files. Eclipse uses the control program to call the compiler, assembler and linker.
- amk** A make utility to maintain, update, and reconstruct groups of programs. The make utility looks whether files are out of date, rebuilds them and determines which other files as a consequence also need to be rebuilt. It supports parallelism which utilizes the multiple cores found on modern host hardware.
- eclipsec** The Eclipse console utility. You can use it to perform a headless build or generate makefiles from the command line without starting the IDE.
- ararm** An archiver. With this utility you create and maintain library files with relocatable object modules (`.obj`) generated by the assembler.
- hldumparm** A high level language (HLL) object dumper. With this utility you can dump information about an absolute object file (`.abs`). Key features are a disassembler with HLL source intermixing and HLL symbol display and a HLL symbol listing of static and global symbols.
- expirearm** A utility to limit the size of the cache by removing all files older than a few days or by removing older files until the total size of the cache is smaller than a specified size.

9.1. Control Program

The control program is a tool that invokes all tools in the toolset for you. It provides a quick and easy way to generate the final absolute object file out of your C/C++ sources without the need to invoke the compiler, assembler and linker manually.

Eclipse uses the control program to call the C++ compiler, C compiler, assembler and linker, but you can call the control program from the command line. The invocation syntax is:

```
ccarm [ option ]... [ file ]... ]...
```

Recognized input files

- Files with a `.cc`, `.cxx` or `.cpp` suffix are interpreted as C++ source programs and are passed to the C++ compiler.
- Files with a `.c` suffix are interpreted as C source programs and are passed to the compiler.
- Files with a `.asm` suffix are interpreted as hand-written assembly source files which have to be passed to the assembler.
- Files with a `.src` suffix are interpreted as compiled assembly source files. They are directly passed to the assembler.
- Files with a `.lib` suffix are interpreted as library files and are passed to the linker.

TASKING VX-toolset for ARM User Guide

- Files with a `.obj` suffix are interpreted as object files and are passed to the linker.
- Files with a `.out` suffix are interpreted as linked object files and are passed to the locating phase of the linker. The linker accepts only one `.out` file in the invocation.
- Files with a `.lsl` suffix are interpreted as linker script files and are passed to the linker.

Options

The control program accepts several command line options. If you specify an unknown option to the control program, the control program looks if it is an option for a specific tool. If so, it passes the option directly to the tool. However, it is recommended to use the control program options **--pass-*** (**-Wcp**, **-Wc**, **-Wa**, **-WI**) to pass arguments directly to tools.

For a complete list and description of all control program options, see [Section 11.6, Control Program Options](#).

Example with verbose output

```
ccarm --verbose test.c
```

The control program calls all tools in the toolset and generates the absolute object file `test.abs`. With option **--verbose (-v)** you can see how the control program calls the tools:

```
+ "path\carm" -o cc3248a.src test.c
+ "path\asarm" -o cc3248b.obj cc3248a.src
+ "path\lkarm" cc3248b.obj -o test.abs --map-file
  -lcarm -lfparm -lrtarm"
```

The control program produces unique filenames for intermediate steps in the compilation process (such as `cc3248a.src` and `cc3248b.obj` in the example above) which are removed afterwards, unless you specify command line option **--keep-temporary-files (-t)**.

Example with argument passing to a tool

```
ccarm --pass-c=-Oc test.c
```

The option **-Oc** is directly passed to the compiler.

9.2. Make Utility `amk`

amk is a make utility that you can use to maintain, update, and reconstruct groups of programs. **amk** features parallelism which utilizes the multiple cores found on modern host hardware, hardening for path names with embedded white space and it has an (internal) interface to provide progress information for updating a progress bar. It does not use an external command shell (`/bin/sh`, `cmd.exe`) but executes commands directly.

The primary purpose of any make utility is to speed up the edit-build-test cycle. To avoid having to build everything from scratch even when only one source file changes, it is necessary to describe dependencies between source files and output files and the commands needed for updating the output files. This is done in a so called "makefile".

9.2.1. Makefile Rules

A makefile dependency rule is a single line of the form:

```
[target ...] : [prerequisite ...]
```

where *target* and *prerequisite* are path names to files. Example:

```
test.obj : test.c
```

This states that target `test.obj` depends on prerequisite `test.c`. So, whenever the latter is modified the first must be updated. Dependencies accumulate: prerequisites and targets can be mentioned in multiple dependency rules (circular dependencies are not allowed however). The command(s) for updating a target when any of its prerequisites have been modified must be specified with leading white space after any of the dependency rule(s) for the target in question. Example:

```
test.obj :
    ccarm test.c # leading white space
```

Command rules may contain dependencies too. Combining the above for example yields:

```
test.obj : test.c
    ccarm test.c
```

White space around the colon is not required. When a path name contains special characters such as `'`, `#` (start of comment), `=` (macro assignment) or any white space, then the path name must be enclosed in single or double quotes. Quoted strings can contain anything except the quote character itself and a newline. Two strings without white space in between are interpreted as one, so it is possible to embed single and double quotes themselves by switching the quote character.

When a target does not exist, its modification time is assumed to be very old. So, **amk** will try to make it. When a prerequisite does not exist possibly after having tried to make it, it is assumed to be very new. So, the update commands for the current target will be executed in that case. **amk** will only try to make targets which are specified on the command line. The default target is the first target in the makefile which does not start with a dot.

Static pattern rules

Static pattern rules are rules which specify multiple targets and construct the prerequisite names for each target based on the target name.

```
[target ...] : target-pattern : [prerequisite-patterns ...]
```

The *target* specifies the targets the rules applies to. The *target-pattern* and *prerequisite-patterns* specify how to compute the prerequisites of each target. Each target is matched against the *target-pattern* to extract a part of the target name, called the *stem*. This stem is substituted into each of the *prerequisite-patterns* to make the prerequisite names (one from each *prerequisite-pattern*).

Each pattern normally contains the character '%' just once. When the *target-pattern* matches a target, the '%' can match any part of the target name; this part is called the *stem*. The rest of the pattern must match exactly. For example, the target `foo.obj` matches the pattern `%.obj`, with `'foo'` as the stem. The targets `foo.c` and `foo.abs` do not match that pattern.

The prerequisite names for each target are made by substituting the stem for the '%' in each prerequisite pattern.

Example:

```
objects = test.obj filter.obj
```

```
all: $(objects)
```

```
$(objects): %.obj: %.c  
    ccarm -c $< -o $@  
    echo the stem is $*
```

Here '\$<' is the automatic variable that holds the name of the prerequisite, '\$@' is the automatic variable that holds the name of the target and '\$*' is the stem that matches the pattern. Internally this translates to the following two rules:

```
test.obj: test.c  
    ccarm -c test.c -o test.obj  
    echo the stem is test  
  
filter.obj: filter.c  
    ccarm -c filter.c -o filter.obj  
    echo the stem is filter
```

Each target specified must match the target pattern; a warning is issued for each target that does not.

Special targets

There are a number of special targets. Their names begin with a period.

Target	Description
<code>.DONE</code>	When the make utility has finished building the specified targets, it continues with the rules following this target.
<code>.INIT</code>	The rules following this target are executed before any other targets are built.
<code>.PHONY</code>	<p>The prerequisites of this target are considered to be phony targets. A phony target is a target that is not really the name of a file. The rules following a phony target are executed unconditionally, regardless of whether a file with that name exists or what its last-modification time is.</p> <p>For example:</p> <pre>.PHONY: clean clean: rm *.obj</pre> <p>With <code>amk clean</code>, the command is executed regardless of whether there is a file named <code>clean</code>.</p>

9.2.2. Makefile Directives

Directives inside makefiles are executed while reading the makefile. When a line starts with the word "include" or "-include" then the remaining arguments on that line are considered filenames whose contents are to be inserted at the current line. "-include" will silently skip files which are not present. You can include several files. Include files may be nested.

Example:

```
include makefile2 makefile3
```

White spaces (tabs or spaces) in front of the directive are allowed.

9.2.3. Macro Definitions

A *macro* is a symbol name that is replaced with its definition before the makefile is executed. Although the macro name can consist of lowercase or uppercase characters, uppercase is an accepted convention. When a line does not start with white space and contains the assignment operator '=', ':=' or '+=' then the line is interpreted as a macro definition. White space around the assignment operator and white space at the end of the line is discarded. Single character macro evaluation happens by prefixing the name with '\$'. To evaluate macros with names longer than one character put the name between parentheses '()' or curly braces '{}'. Macro names may contain anything, even white space or other macro evaluations.

Example:

```
DINNER = $(FOOD) and $(BEVERAGE)
FOOD = pizza
```

TASKING VX-toolset for ARM User Guide

```
BEVERAGE = sparkling water
FOOD += with cheese
```

With the **+=** operator you can add a string to an existing macro. An extra space is inserted before the added string automatically.

Macros are evaluated recursively. Whenever `$(DINNER)` or `${DINNER}` is mentioned after the above, it will be replaced by the text "pizza with cheese and sparkling water". The left hand side in a macro definition is evaluated before the definition takes place. Right hand side evaluation depends on the assignment operator:

- = Evaluate the macro at the moment it is used.
- := Evaluate the replacement text before defining the macro.

Subsequent **+=** assignments will inherit the evaluation behavior from the previous assignment. If there is none, then **+=** is the same as **=**. The default value for any macro is taken from the environment. Macro definitions inside the makefile overrule environment variables. Macro definitions on the **amk** command line will be evaluated first and overrule definitions inside the makefile.

Predefined macros

Macro	Description
\$	This macro translates to a dollar sign. Thus you can use "\$\$" in the makefile to represent a single "\$".
@	The name of the current target. When a rule has multiple targets, then it is the name of the target that caused the rule commands to be run.
*	The basename (or stem) of the current target. The stem is either provided via a static pattern rule or is calculated by removing all characters found after and including the last dot in the current target name. If the target name is 'test.c' then the stem is 'test' (if the target was not created via a static pattern rule).
<	The name of the first prerequisite.
MAKE	The amk path name (quoted if necessary). Optionally followed by the options -n and -s .
ORIGIN	The name of the directory where amk is installed (quoted if necessary).
SUBDIR	The argument of option -G . If you have nested makes with -G options, the paths are combined. This macro is defined in the environment (i.e. default macro value).

The @, * and < macros may be suffixed by 'D' to specify the directory component or by 'F' to specify the filename component. `$(@D)` evaluates to the directory name holding the file `$(@F)`. `$(@D)/$(@F)` is equivalent to `$@`. Note that on MS-Windows most programs accept forward slashes, even for UNC path names.

The result of the predefined macros @, * and < and 'D' and 'F' variants is not quoted, so it may be necessary to put quotes around it.

Note that stem calculation can cause unexpected values. For example:

\$@	\$*
/home/.wine/test	/home/
/home/test/.project	/home/test/
../file	/.

Macro string substitution

When the macro name in an evaluation is followed by a colon and equal sign as in

```
$(MACRO:string1=string2)
```

then **amk** will replace *string1* at the end of every word in $$(MACRO)$ by *string2* during evaluation. When $$(MACRO)$ contains quoted path names, the quote character must be mentioned in both the original string and the replacement string¹. For example:

```
$(MACRO:.obj=".d")
```

9.2.4. Makefile Functions

A function not only expands but also performs a certain operation. The following functions are available:

$$(filter pattern ...,item ...)$

The *filter* function filters a list of items using a pattern. It returns *items* that do match any of the *pattern* words, removing any items that do not match. The patterns are written using '%',

```
${filter %.c %.h, test.c test.h test.obj readme.txt .project output.c}
```

results in:

```
test.c test.h output.c
```

$$(filter-out pattern ...,item ...)$

The *filter-out* function returns all *items* that do not match any of the *pattern* words, removing the items that do match one or more. This is the exact opposite of the *filter* function.

```
${filter-out %.c %.h, test.c test.h test.obj readme.txt .project output.c}
```

results in:

```
test.obj readme.txt .project
```

$$(foreach var-name, item ..., action)$

The *foreach* function runs through a list of items and performs the same *action* for each *item*. The *var-name* is the name of the macro which gets dynamically filled with an item while iterating through the *item* list. In the *action* you can refer to this macro. For example:

¹Internally, **amk** tokenizes the evaluated text, but performs substitution on the original input text to preserve compatibility here with existing make implementations and POSIX.

TASKING VX-toolset for ARM User Guide

```
 ${foreach T, test filter output, ${T}.c ${T}.h}
```

results in:

```
 test.c test.h filter.c filter.h output.c output.h
```

9.2.5. Conditional Processing

Lines containing `ifdef`, `ifndef`, `else` or `endif` are used for conditional processing of the makefile. They are used in the following way:

```
ifdef macro-name  
if-lines  
else  
else-lines  
endif
```

The *if-lines* and *else-lines* may contain any number of lines or text of any kind, even other `ifdef`, `ifndef`, `else` and `endif` lines, or no lines at all. The `else` line may be omitted, along with the *else-lines* following it. White spaces (tabs or spaces) in front of preprocessing directives are allowed.

First the *macro-name* after the `ifdef` command is checked for definition. If the macro is defined then the *if-lines* are interpreted and the *else-lines* are discarded (if present). Otherwise the *if-lines* are discarded; and if there is an `else` line, the *else-lines* are interpreted; but if there is no `else` line, then no lines are interpreted.

When you use the `ifndef` line instead of `ifdef`, the macro is tested for not being defined. These conditional lines can be nested to any level.

You can also add tests based on strings. With `ifeq` the result is true if the two strings match, with `ifneq` the result is true if the two strings do not match. They are used in the following way:

```
ifeq(string1,string2)  
if-lines  
else  
else-lines  
endif
```

9.2.6. Makefile Parsing

`amk` reads and interprets a makefile in the following order:

1. When the last character on a line is a backslash (`\`) (i.e. without trailing white space) then that line and the next line will be concatenated, removing the backslash and newline.
2. The unquoted `#` character indicates start of comment and may be placed anywhere on a line. It will be removed in this phase.

```
# this comment line is continued\  
on the next line
```

3. Trailing white space is removed.
4. When a line starts with white space and it is not followed by a directive or preprocessing directive, then it is interpreted as a command for updating a target.
5. Otherwise, when a line contains the unquoted text '=', '+=' or ':=' operator, then it will be interpreted as a macro definition.
6. Otherwise, all macros on the line are evaluated before considering the next steps.
7. When the resulting line contains an unquoted ':' the line is interpreted as a dependency rule.
8. When the first token on the line is "include" or "-include" (which by now must start on the first column of the line), **amk** will execute the directive.
9. Otherwise, the line must be empty.

Macros in commands for updating a target are evaluated right before the actual execution takes place (or would take place when you use the **-n** option).

9.2.7. Makefile Command Processing

A line with leading white space (tabs or spaces) without a (preprocessing) directive is considered as a command for updating a target. When you use the option **-j** or **-J**, **amk** will execute the commands for updating different targets in parallel. In that case standard input will not be available and standard output and error output will be merged and displayed on standard output only after the commands have finished for a target.

You can precede a command by one or more of the following characters:

- @ Do not show the command. By default, commands are shown prior to their output.
- Continue upon error. This means that **amk** ignores a non-zero exit code of the command.
- + Execute the command, even when you use option **-n** (dry run).
- | Execute the command on the foreground with standard input, standard output and error output available.

Built-in commands

Command	Description
true	This command does nothing. Arguments are ignored.
false	This command does nothing, except failing with exit code 1. Arguments are ignored.
echo <i>arg...</i>	Display a line of text.
exit <i>code</i>	Exit with defined code. Depending on the program arguments and/or the extra rule options '-' this will cause amk to exit with the provided code. Please note that 'exit 0' has currently no result.

Command	Description
<code>argfile file arg...</code>	Create an argument file suitable for the --option-file (-f) option of all the other tools. The first <code>argfile</code> argument is the name of the file to be created. Subsequent arguments specify the contents. An existing argument file is not modified unless necessary. So, the argument file itself can be used to create a dependency to options of the command for updating a target.
<code>rm [option]... file...</code>	Remove the specified file(s). The following options are available: <ul style="list-style-type: none"> -r, --recursive Remove directories and their contents recursively. -f, --force Force deletion. Ignore non-existent files, never prompt. -i, --interactive Interactive. Prompt before every removal. -v, --verbose Verbose mode. Explain what is being done. -m file Read options from <i>file</i>.. -?, --help Show usage.

9.2.8. Calling the amk Make Utility

The invocation syntax of **amk** is:

```
amk [option]... [target]... [macro=def]...
```

For example:

```
amk test.abs
```

<i>target</i>	You can specify any target that is defined in the makefile. A target can also be one of the intermediate files specified in the makefile.
<i>macro=def</i>	Macro definition. This definition remains fixed for the amk invocation. It overrides any regular definitions for the specified macro within the makefiles and from the environment. It is not inherited by subordinate amk 's
<i>option</i>	For a complete list and description of all amk make utility options, see Section 11.7, Parallel Make Utility Options .

Exit status

The make utility returns an exit status of 1 when it halts as a result of an error. Otherwise it returns an exit status of 0.

9.3. Eclipse Console Utility

eclipsec is the console executable variant of Eclipse. Unlike the other utilities it is part of Eclipse and therefore it is present in the `eclipse` sub-directory of the product (*installation-path*\eclipse) instead of in the `bin` directory. You can use it to start Eclipse from a Windows Command Prompt. This section describes how to use this utility to perform the following actions:

- Build a project from the command line without starting the Eclipse IDE.
- Generate makefiles from the command line without starting the Eclipse IDE.

The general invocation syntax of **eclipsec** is:

```
installation-dir\eclipse\eclipsec [option]...
```

Note that in this manual we only describe the options that are of interest to perform the desired actions.

9.3.1. Headless Build

The Eclipse workbench (IDE) is referred to as 'head'. Headless build essentially means running builds from the command line without starting the Eclipse IDE.

To perform a headless build

Use the following invocation syntax in a Windows Command Prompt:

```
installation-dir\eclipse\eclipsec -nosplash -data workspace-location
    -application com.tasking.managedbuilder.headlessbuild
    -build {project | all}
```

Explanation of the options used:

-nosplash	Do not generate the Eclipse splash screen on startup.
-data <i>workspace-location</i>	The location of your workspace. If you used the default settings when installing the product, the workspace location is <code>C:\Users\user\workspace_arm_version</code> (Windows 7 or higher).
-application	<code>com.tasking.managedbuilder.headlessbuild</code> is the application to use for a headless build.
-build { <i>project</i> all }	Perform a headless build. When you specify a project name, Eclipse builds the active configuration of the specified project. With all , Eclipse builds all active configurations of all projects in the specified workspace.

For example, to build the active configuration of `myproject`, enter:

```
eclipsec -nosplash -data "C:\Users\User\workspace_arm_vx.yrz"
    -application com.tasking.managedbuilder.headlessbuild
    -build myproject
```

TASKING VX-toolset for ARM User Guide

Output similar to the following appears on the console:

```
**** Build of configuration Debug for project myproject ****

"C:\Program Files\TASKING\carm vx.yrz\bin\amk" -j4 all -a
Compiling myproject.c
Linking to myproject.abs

Time consumed: 397 ms
**** End of build ****
```

9.3.2. Generating Makefiles from the Command Line

You can use **eclipsec** to generate makefiles for one or more of your projects, without starting the Eclipse IDE. This can be useful for testing and batch processing.

To generate makefiles on the command line

Use the following invocation syntax in a Windows Command Prompt:

```
installation-dir\eclipse\eclipsec -nosplash -data workspace-location
    -application com.tasking.managedbuilder.headlessbuild
    -generateMakefile {project[/configuration] | all}
```

Explanation of the options used:

-nosplash	Do not generate the Eclipse splash screen on startup.
-data workspace-location	The location of your workspace. If you used the default settings when installing the product, the workspace location is C:\Users\user\workspace_arm_version (Windows 7 or higher).
-application	com.tasking.managedbuilder.headlessbuild is the application to use for generating makefiles on the command line.
-generateMakefile {project[/configuration] all *.*.*}	Generate makefile(s). When you specify a project name, Eclipse generates makefiles for all configurations of the specified project. When you also specify a configuration, Eclipse generates makefiles for the specified configuration of the project. With all , Eclipse generates makefiles for all active configurations of all projects in the specified workspace. With *.*.* Eclipse generates makefiles for all configurations of all projects in the specified workspace.

For example, to generate makefiles for all configurations of `myproject`, enter:

```
eclipsec -nosplash -data "C:\Users\User\workspace_arm_vx.yrz"
    -application com.tasking.managedbuilder.headlessbuild
    -generateMakefile myproject
```

Output similar to the following appears on the console:

```
**** Build Makefile of configuration Debug for project myproject ****
```

```
**** Build Makefile of configuration Release for project myproject ****
```

The Debug and Release directory of myproject now contain updated makefiles.

9.4. Archiver

The archiver **ararm** is a program to build and maintain your own library files. A library file is a file with extension `.lib` and contains one or more object files (`.obj`) that may be used by the linker.

The archiver has five main functions:

- Deleting an object module from the library
- Moving an object module to another position in the library file
- Replacing an object module in the library or add a new object module
- Showing a table of contents of the library file
- Extracting an object module from the library

The archiver takes the following files for input and output:

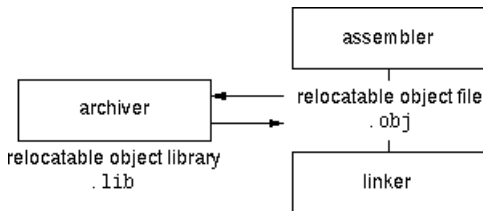

The linker optionally includes object modules from a library if that module resolves an external symbol definition in one of the modules that are read before.

9.4.1. Calling the Archiver

You can create a library in Eclipse, which calls the archiver or you can call the archiver on the command line.

To create a library in Eclipse

Instead of creating an ARM absolute ELF file, you can choose to create a library. You do this when you create a new project with the New C/C++ Project wizard.

1. From the **File** menu, select **New » TASKING ARM C/C++ Project**.
The New C/C++ Project wizard appears.
2. Enter a project name.
3. In the **Project type** box, select **TASKING ARM Library** and click **Next >**.
4. Follow the rest of the wizard and click **Finish**.
5. Add the files to your project.

6. Build the project as usual. For example, select **Project » Build Project** (🔧).

Eclipse builds the library. Instead of calling the linker, Eclipse now calls the archiver.

Command line invocation

You can call the archiver from the command line. The invocation syntax is:

```
ararm key_option [sub_option...] library [object_file]
```

<i>key_option</i>	With a key option you specify the main task which the archiver should perform. You must <i>always</i> specify a key option.
<i>sub_option</i>	Sub-options specify into more detail how the archiver should perform the task that is specified with the key option. It is not obligatory to specify sub-options.
<i>library</i>	The name of the library file on which the archiver performs the specified action. You must always specify a library name, except for the options -? and -V . When the library is not in the current directory, specify the complete path (either absolute or relative) to the library.
<i>object_file</i>	The name of an object file. You must always specify an object file name when you add, extract, replace or remove an object file from the library.

Options of the archiver utility

The following archiver options are available:

Description	Option	Sub-option
Main functions (key options)		
Replace or add an object module	-r	-a -b -c -n -u -v
Extract an object module from the library	-x	-o -v
Delete object module from library	-d	-v
Move object module to another position	-m	-a -b -v
Print a table of contents of the library	-t	-s0 -s1
Print object module to standard output	-p	
Sub-options		
Append or move new modules after existing module <i>name</i>	-a name	
Append or move new modules before existing module <i>name</i>	-b name	
Suppress the message that is displayed when a new library is created	-c	
Create a new library from scratch	-n	
Preserve last-modified date from the library	-o	
Print symbols in library modules	-s{0 1}	
Replace only newer modules	-u	

Description	Option	Sub-option
Verbose	-v	
Miscellaneous		
Display options	-?	
Display description of one or more diagnostic messages	--diag	
Display version header	-V	
Read options from <i>file</i>	-f file	
Suppress warnings above level <i>n</i>	-wn	

For a complete list and description of all archiver options, see [Section 11.8, Archiver Options](#).

9.4.2. Archiver Examples

Create a new library

If you add modules to a library that does not yet exist, the library is created. To create a new library with the name `mylib.lib` and add the object modules `cstart.obj` and `calc.obj` to it:

```
ararm -r mylib.lib cstart.obj calc.obj
```

Add a new module to an existing library

If you add a new module to an existing library, the module is added at the end of the module. (If the module already exists in the library, it is replaced.)

```
ararm -r mylib.lib mod3.obj
```

Print a list of object modules in the library

To inspect the contents of the library:

```
ararm -t mylib.lib
```

The library has the following contents:

```
cstart.obj
calc.obj
mod3.obj
```

Move an object module to another position

To move `mod3.obj` to the beginning of the library, position it just before `cstart.obj`:

```
ararm -mb cstart.obj mylib.lib mod3.obj
```

Delete an object module from the library

To delete the object module `cstart.obj` from the library `mylib.lib`:

```
ararm -d mylib.lib cstart.obj
```

Extract all modules from the library

Extract all modules from the library `mylib.lib`:

```
ararm -x mylib.lib
```

9.5. HLL Object Dumper

The high level language (HLL) dumper **hldumparm** is a program to dump information about an absolute object file (.abs). Key features are a disassembler with HLL source intermixing and HLL symbol display and a HLL symbol listing of static and global symbols.

9.5.1. Invocation

Command line invocation

You can call the HLL dumper from the command line. The invocation syntax is:

```
hldumparm [option]... file...
```

The input file must be an ELF file with or without DWARF debug info (.abs).

The HLL dumper can process multiple input files. Files and options can be intermixed on the command line. Options apply to all supplied files. If multiple files are supplied, the disassembly of each file is preceded by a header to indicate which file is dumped. For example:

```
===== file.abs =====
```

For a complete list and description of all options, see [Section 11.9, HLL Object Dumper Options](#). With **hldumparm --help** you will see the options on `stdout`.

9.5.2. HLL Dump Output Format

The HLL dumper produces output in text format by default, but you can also specify the XML output format with **--output-type=xml**. The XML output is mainly for use in the Eclipse editor. The output is printed on `stdout`, unless you specify an output file with **--output=filename**.

The parts of the output are dumped in the following order:

1. Module list
2. Section list
3. Section dump (disassembly)
4. HLL symbol table
5. Assembly level symbol table
6. Note sections

With the option **--dump-format=flag** you can control which parts are shown. By default, all parts are shown.

Example

Suppose we have a simple "Hello World" program in a file called `hello.c`. We call the control program as follows:

```
ccarm -g -t hello.c
```

Option `-g` tells to include DWARF debug information. Option `-t` tells to keep the intermediate files. This command results (among other files) in the file `hello.abs` (the absolute output file).

We can dump information about the absolute object file with the following command:

```
hldumparm hello.abs
```

```
----- Module list -----
Name      Full path
hello.c   hello.c

----- Section list -----
Address  Size  Align Type    Name
00000690    24    4 text    .text
000006b4     6    4 romdata .rodata
00040180     4    4 bss     .data
000006a8    11    4 romdata .rodata

----- Section dump -----
        .section .data, '[.data]', at(0x000000e8)
        .db b8,06,00,00                                ; ....
        .endsec

                                .section .text, at(0x00000690)
00000690 08 00 9f e5 main          ldr    r0, [r15, #+0x8]
00000694 00 10 90 e5          ldr    r1, [r0, #+0x0]
00000698 04 00 9f e5          ldr    r0, [r15, #+0x4]
0000069c 74 ff ff ea          b      printf
000006a0 80 01          .dh 0180
000006a2 04 00          .dh 0004
000006a4 a8 06          .dh 06a8
000006a6 00 00          .dh 0000
                                .endsec

        .section .data, '.rodata', at(0x000006a8)
        .db 48,65,6c,6c,6f,20,25,73,21,0a,00          ; Hello %s!..
        .endsec

        .section .data, '.rodata', at(0x000006b4)
        .db 77,6f,72,6c,64,00                          ; world.
        .endsec
```

TASKING VX-toolset for ARM User Guide

----- HLL symbol table -----

Address	Size	HLL Type	Name
00000390	88	void	Reset_Handler()
00000408	104	void	__init()
00000474	64	int	printf(const char * restrict format, ...)
00000690	16	void	main()
00040000	24	struct	_dbg_request [dbg.c]
00040018	80	static char	stdin_buf[80] [_iob.c]
00040068	80	static char	stdout_buf[80] [_iob.c]
000400b8	200	struct _iobuf	_iob[10] [_iob.c]
00040180	4	char	* world [hello.c]

----- assembly level symbol table -----

Address	Size	Type	Name
00000000			
00000000			[.data.libc]
00000000			[.data]
00000000			_vector_0
00000000			hello.c
00000390	120	code	Reset_Handler
00000474	72	code	printf
00000690	24	code	main
00040180	4	data	world

----- .note sections -----

No .note sections present

Module list

This part lists all modules (C/C++ files) found in the object file(s). It lists the filename and the complete path name at the time the module was built.

Section list

This part lists all sections found in the object file(s).

Address	The start address of the section. Hexadecimal, 8 digits, 32-bit.
Size	The size (length) of the section in bytes. Decimal, filled up with spaces.
Align	The alignment of the section in number of bytes. Decimal, filled up with spaces.
Type	The section type.
Name	The name of the section.

With option `--sections=name[,name]...` you can specify a list of sections that should be dumped.

Section dump

This part contains the disassembly. It consists of the following columns:

address column	Contains the address of the instruction or directive that is shown in the disassembly. If the section is relocatable the section start address is assumed to be 0. The address is represented in hexadecimal and has a fixed width. The address is padded with zeros. No 0x prefix is displayed. For example, on a 32-bit architecture, the address 0x32 is displayed as 00000032.
encoding column	Shows the hexadecimal encoding of the instruction (code sections) or it shows the hexadecimal representation of data (data sections). The encoding column has a maximum width of eight digits, i.e. it can represent a 32-bit hexadecimal value. The encoding is padded to the size of the data or instruction. For example, a 16-bit instruction only shows four hexadecimal digits. The encoding is aligned left and padded with spaces to fill the eight digits.
label column	Displays the label depending on the option <code>--symbols=[hll asm none]</code> . The default is asm , meaning that the low level (ELF) symbols are used. With hll , HLL (DWARF) symbols are used. With none , no symbols will be included in the disassembly.
disassembly column	For code sections the instructions are disassembled. Operands are replaced with labels, depending on the option <code>--symbols=[hll asm none]</code> . The contents of data sections are represented by directives. A new directive will be generated for each symbol. ELF labels in the section are used to determine the start of a directive. ROM sections are represented with <code>.db</code> , <code>.dh</code> , <code>.dw</code> , <code>.dd</code> kind of directives, depending on the size of the data. RAM sections are represented with <code>.ds</code> directives, with a size operand depending on the data size. This can be either the size specified in the ELF symbol, or the size up to the next label.

With option `--hex`, no directives will be generated for ROM data sections and no disassembly dump will be done for code sections. Instead a hex dump is done with the following format:

```
AAAAAAAA H0 H1 H2 H3 H4 H5 H6 H7 H8 H9 HA HB HC HD HE HF RRRRRRRRRRRRRRRR
```

where,

A = Address (8 digits, 32-bit)

Hx = Hex contents, one byte (16 bytes max)

R = ASCII representation (16 characters max)

For example:

```

                                section 7 (.rodata):
000006a8 48 65 6c 6c 6f 20 25 73 21 0a 00                Hello %s!..

```

With option `--hex`, RAM sections will be represented with only a start address and a size indicator:

```
AAAAAAAA Space: 48 bytes
```

With option `--disassembly-intermix` you can intermix the disassembly with HLL source code.

HLL symbol table

This part contains a symbol listing based on the HLL (DWARF) symbols found in the object file(s). The symbols are sorted on address.

Address	The start address of the symbol. Hexadecimal, 8 digits, 32-bit.
Size	The size of the symbol from the DWARF info in bytes.
HLL Type	The HLL symbol type.
Name	The name of the HLL symbol.

HLL arrays are indicated by adding the size in square brackets to the symbol name. For example:

```
00040018      80 static char          stdin_buf[80] [_iob.c]
```

With option **--expand-symbols=+basic-types** HLL struct and union symbols are listed including all fields. Array members are expanded in one array member per line regardless of the HLL type. For example:

```
00040018      80 static char          stdin_buf[80] [_iob.c]
00040018         1 char
00040019         1 char
0004001a         1 char
...
00040067         1 char
```

HLL struct and union symbols are listed by default without fields. For example:

```
00040000      24 struct                _dbg_request [dbg.c]
```

With option **--expand-symbols** all struct, union and array fields are included as well. For the fields the types and names are indented with two spaces. For example:

```
00040000      24 struct                _dbg_request [dbg.c]
00040000         4 int                _errno
00040004         4 enum                nr
00040008      16 union                u
00040008         4 struct                exit
00040008         4 int                status
00040008         8 struct                open
00040008         4 const char          * pathname
0004000c         2 unsigned short int  flags
...
```

Functions are displayed with the full function prototype. Size is the size of the function. HLL Type is the return type of the function. For example:

```
00000474      64 int                printf(const char * restrict format, ...)
```

The local and static symbols get an identification between square brackets. The filename is printed and if a function scope is known the function name is printed between the square brackets as well. If multiple files with the same name exist, the unique part of the path is added. For example:

```

00040100      4 int                count [file.c, somefunc()]
00040104      4 int                count [x\a.c]
00040108      4 int                count [y\a.c, foo()]

```

Global symbols do not get information in square brackets.

Assembly level symbol table

This part contains a symbol listing based on the assembly level (ELF) symbols found in the object file(s). The symbols are sorted on address.

Address	The start address of the symbol. Hexadecimal, 8 digits, 32-bit.
Size	The size of the symbol from the ELF info in bytes. If this field is empty, the size is zero.
Type	Code or Data, depending on the section the symbol belongs to. If this field is empty, the symbol does not belong to a section.
Name	The name of the ELF symbol.

9.6. Expire Cache Utility

With the utility **expirearm** you can limit the size of the cache (C compiler [option --cache](#)) by removing all files older than a few days or by removing older files until the total size of the cache is smaller than a specified size. See also [Section 12.5, Compiler Cache](#).

The invocation syntax is:

```
expirearm [option]... cache-directory
```

The compiler cache is present in the directory `carmcache` under the specified *cache-directory*.

For a complete list and description of all options, see [Section 11.10, Expire Cache Utility Options](#). With `expirearm --help` you will see the options on `stdout`.

Examples

To remove all files older than seven days, enter:

```
expirearm --days=7 "installation-dir\mproject\.cache"
```

To reduce the compiler cache size to 4 MB, enter:

```
expirearm --megabytes=4 "installation-dir\mproject\.cache"
```

Older files are removed until the total size of the cache is smaller than 4 MB.

To clear the compiler cache, enter:

```
expirearm --megabytes=0 "installation-dir\mproject\.cache"
```

Chapter 10. Using the Debugger

This chapter describes the debugger and how you can run and debug a C or C++ application. This chapter only describes the TASKING specific parts.

10.1. Reading the Eclipse Documentation

Before you start with this chapter, it is recommended to read the Eclipse documentation first. It provides general information about the debugging process. This chapter guides you through a number of examples using the TASKING debugger with simulation as target.

You can find the Eclipse documentation as follows:

1. Start Eclipse.
2. From the **Help** menu, select **Help Contents**.
The help screen overlays the Eclipse Workbench.
3. In the left pane, select **C/C++ Development User Guide**.
4. Open the **Getting Started** entry and select **Debugging projects**.

This Eclipse tutorial provides an overview of the debugging process. Be aware that the Eclipse example does not use the TASKING tools and TASKING debugger.

10.2. Creating a Customized Debug Configuration

Before you can debug a project, you need a Debug launch configuration. Such a configuration, identified by a name, contains all information about the debug project: which debugger is used, which project is used, which binary debug file is used, which perspective is used, ... and so forth.

If you want to debug on a target board, you have to create a custom debug configuration for your target board, otherwise you have to create a debug launch configuration for the TASKING simulator.

To debug a project, you need at least one opened and active project in your workbench. In this chapter, it is assumed that the `myproject` is opened and active in your workbench.

Create or customize your debug configuration

To create or change a debug configuration follow the steps below.

1. From the **Debug** menu, select **Debug Configurations...**
The Debug Configurations dialog appears.
2. Select **TASKING C/C++ Debugger** and click the **New launch configuration** button ()

TASKING VX-toolset for ARM User Guide

) to add a new configuration.

Or: In the left pane, select the configuration you want to change, for example, **TASKING C/C++ Debugger » myproject**.

3. In the **Name** field enter the name of the configuration. By default, this is the name of the project, but you can give your configuration any name you want to distinguish it from the project name. For example enter `myproject.simulator` to identify the simulator debug configuration.
4. On the **Target** tab, select the **ARM Simulator** or any of the target boards.

The dialog shows several tabs.

Target tab

On the **Target** tab you can select on which target the application should be debugged. An application can run on an external evaluation board, or on a simulator using your own PC. On this tab you can also select the connection settings (J-Link, RS-232, TCP/IP). The information in this tab is based on the Debug Target Configuration (DTC) files as explained in [Chapter 18, Debug Target Configuration Files](#). If you select **Show all targets** you can see an overview of all supported evaluation boards.

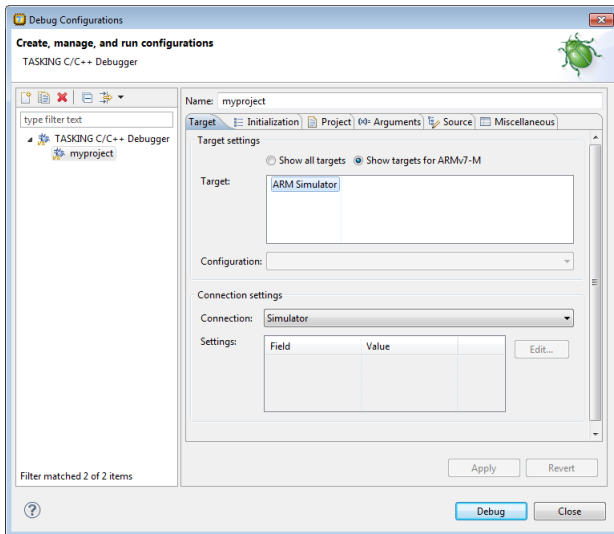

Initialization tab

On the **Initialization** tab enable one or more of the following options:

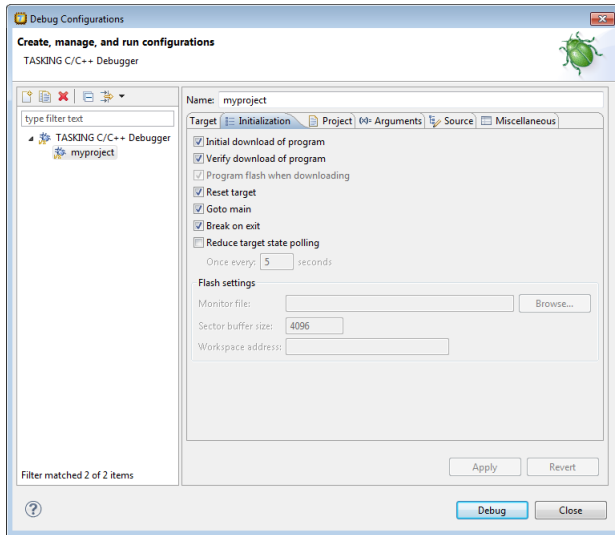

- **Initial download of program**

If enabled, the target application is downloaded onto the target. If disabled, only the debug information in the file is loaded, which may be useful when the application has already been downloaded (or flashed) earlier. If downloading fails, the debugger will shut down.

- **Verify download of program**

If enabled, the debugger verifies whether the code and data has been downloaded successfully. This takes some extra time but may be useful if the connection to the target is unreliable.

- **Program flash when downloading**

If enabled, also flash devices are programmed (if necessary). Flash programming will not work when you use a simulator.

- **Reset target**

If enabled, the target is immediately reset after downloading has completed.

- **Goto main**

If enabled, only the C startup code is processed when the debugger is launched. The application stops executing when it reaches the first C instruction in the function `main()`. Usually you enable this option in combination with the option **Reset Target**.

- **Break on exit**

If enabled, the target halts automatically when the `exit()` function is called.

- **Reduce target state polling**

TASKING VX-toolset for ARM User Guide

If you have set a breakpoint, the debugger checks the status of the target every *number* of seconds to find out if the breakpoint is hit. In this field you can change the polling frequency.

- **Monitor file (Flash settings)**

Filename of the monitor, usually an Intel Hex or S-Record file.

- **Sector buffer size (Flash settings)**

Specifies the buffer size for buffering a flash sector.

- **Workspace address (Flash settings)**

The address of the workspace of the flash programming monitor.

Project tab

On the **Project** tab, you can set the properties for the debug configuration such as a name for the project and the application binary file which are used when you choose this configuration.

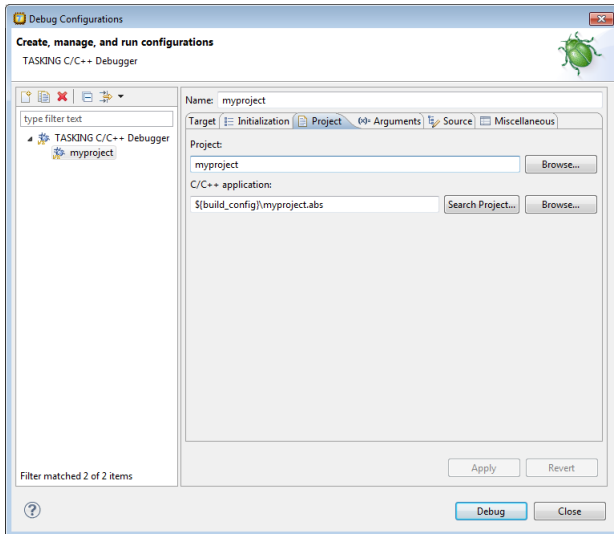

- In the **Project** field, you can choose the project for which you want to make a debug configuration. Because the project `myproject` is the active project, this project is filled in automatically. Click the `Browse...` button to select a different project. Only the *opened* projects in your workbench are listed.
- In the **C/C++ Application** field, you can choose the binary file to debug. The file `myproject.abs` is automatically selected from the active project.

Arguments tab

If your application's `main()` function takes arguments, you can pass them in this tab. Arguments are conventionally passed in the `argv[]` array. Because this array is allocated in target memory, make sure you have allocated sufficient memory space for it.

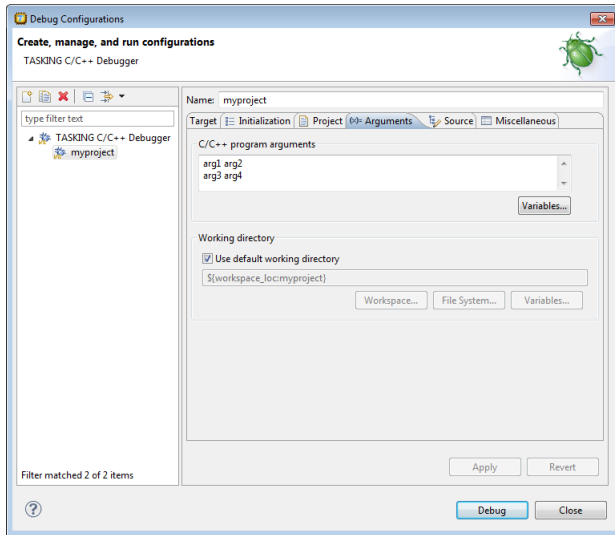

Source tab

On the **Source** tab, you can add additional source code locations in which the debugger should search for debug data.

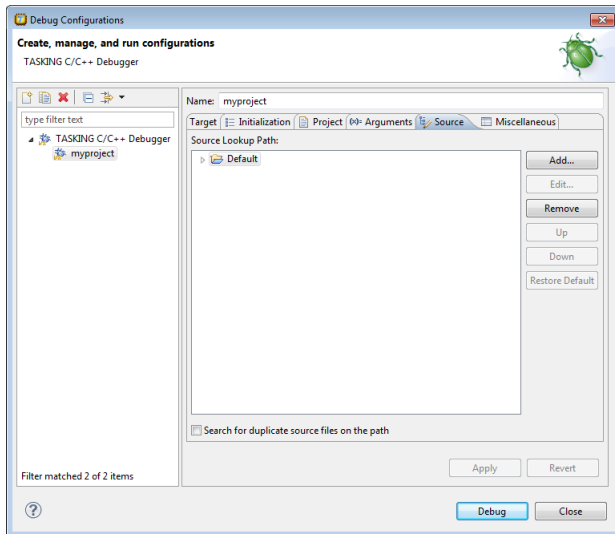

- Usually, the default source code location is correct.

Miscellaneous tab

On the **Miscellaneous** tab you can specify several file locations.

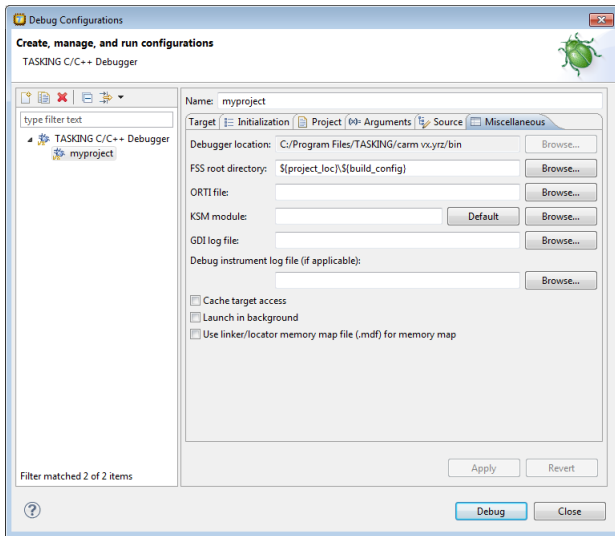

- **Debugger location**

The location of the debugger itself. This should not be changed.

- **FSS root directory**

The initial directory used by file system simulation (FSS) calls. See the description of the [FSS view](#).

- **ORTI file and KSM module**

If you wish to use the debugger's special facilities for kernel-aware debugging, specify the name of a Kernel Debug Interface (KDI) compatible KSM module (shared library) in the appropriate edit box. The toolset comes with a KSM suitable for OSEK kernels. If you wish to use this, browse for the file `osek_radm.dll` in the `bin` directory of the toolset. See also the description of the [RTOS view](#).

- **GDI log file and Debug instrument log file**

You can use the options GDI log file and Debug instrument log file (if applicable) to control the generation of internal log files. These are primarily intended for use by or at the request of Altium support personnel.

- **Cache target access**

Except when using a simulator, the debugger's performance is generally strongly dependent on the throughput and latency of the connection to the target. Depending on the situation, enabling this option may result in a noticeable improvement, as the debugger will then avoid re-reading registers and memory while the target remains halted. However, be aware that this may cause the debugger to show the wrong data if tasks with a higher priority or external sources can influence the halted target's state.

- **Launch in background**

When this option is disabled you will see a progress bar when the debugger starts. If you do not want to see the progress bar and want that the debugger launches in the background you can enable this option.

- **Use linker/locator memory map file (.mdf) for memory map**

You can use this option to find errors in your application that cause access to non-existent memory or cause an attempt to write to read-only memory. When building your project, the linker/locator creates a memory description file (.mdf) file which describes the memory regions of the target you selected in your project properties. The debugger uses this file to initialize the debugging target.

This option is only useful in combination with a simulator as debug target. The debugger may fail to start if you use this option in combination with other debugging targets than a simulator.

10.3. Troubleshooting

If the debugger does not launch properly, this is likely due to mistakes in the settings of the execution environment or to an improper connection between the host computer and the execution environment. Always read the notes for your particular execution environment.

Some common problems you may check for, are:

Problem	Solution
Wrong device name in the launch configuration	Make sure the specified device name is correct.
Invalid baud rate	Specify baud rate that matches the baud rate the execution environment is configured to expect.
No power to the execution environment.	Make sure the execution environment or attached probe is powered.
Wrong type of RS-232 cable.	Make sure you are using the correct type of RS-232 cable.
Cable connected to the wrong port on the execution environment or host.	Some target machines and hosts have several ports. Make sure you connect the cable to the correct port.
Conflict between communication ports.	A device driver or background application may use the same communications port on the host system as the debugger. Disable any service that uses the same port-number or choose a different port-number if possible.
Port already in use by another user.	The port may already be in use by another user on some UNIX hosts, or being allocated by a login process. Some target machines and hosts have several ports. Make sure you connect the cable to the correct port.

Device specific problem with WFE/WFI

Depending on the device, the clock feeding the debug interface may shut down when the processor executes a WFE or WFI instruction, causing debugging to fail. Try to avoid the `__WFE()` and `__WFI()` intrinsic functions in this case.

10.4. TASKING Debug Perspective

After you have launched the debugger, you are either asked if the TASKING Debug perspective should be opened or it is opened automatically. The Debug perspective consists of several views.

To open views in the Debug perspective:

1. Make sure the Debug perspective is opened
2. From the **Window** menu, select **Show View »**
3. Select a view from the menu or choose **Other...** for more views.

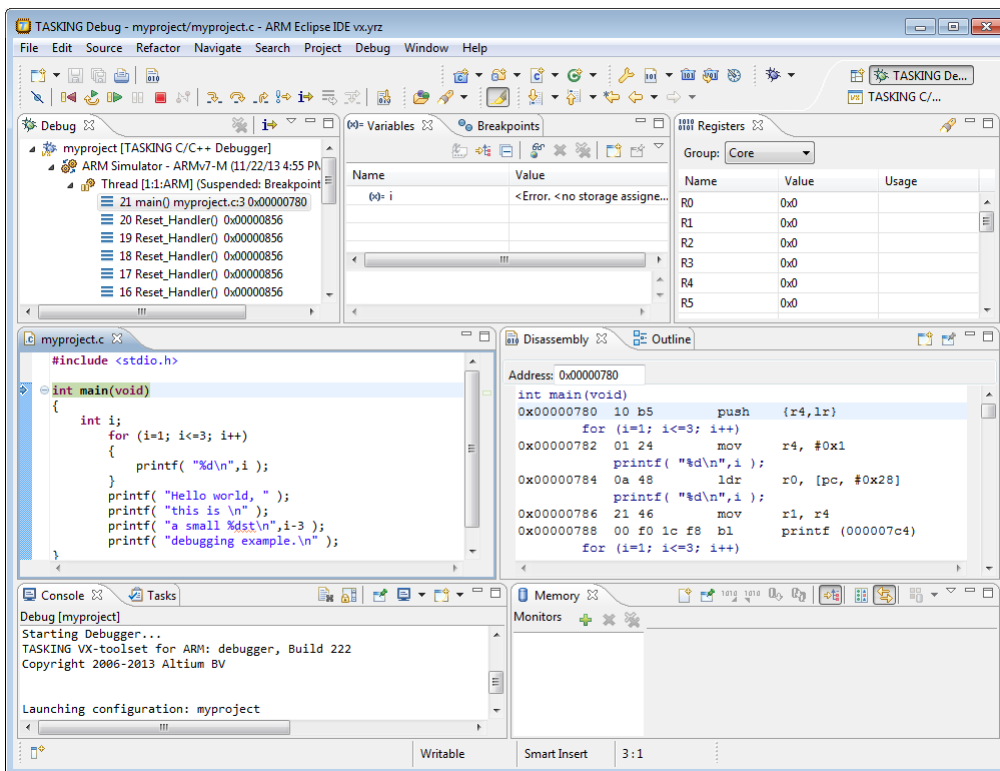

By default, the Debug perspective is opened with the following views:



10.4.1. Debug View

The Debug view shows the target information in a tree hierarchy shown below with a sample of the possible icons:

Icon	Session item	Description
	Launch instance	Launch configuration name and launch type

Icon	Session item	Description
	Debugger instance	Debugger name and state
	Thread instance	Thread number and state
	Stack frame instance	Stack frame number, function, file name, and file line number











Stack display



During debugging (running) the actual stack is displayed as it increases or decreases during program execution. By default, all views present information that is related to the current stack item (variables, memory, source code etc.). To obtain the information from other stack items, click on the item you want.

The Debug view displays stack frames as child elements. It displays the reason for the suspension beside the thread, (such as end of stepping range, breakpoint hit, and signal received). When a program exits, the exit code is displayed.





The Debug view contains numerous functions for controlling the individual stepping of your programs and controlling the debug session. You can perform actions such as terminating the session and stopping the program. All functions are available from the right-click menu, though commonly used functions are also available from the toolbar.

Controlling debug sessions



Icon	Action	Description
	Remove all	Removes all terminated launches.
	Reset target system	Resets the target system and restarts the application.
	Restart	Restarts the application. The target system is <i>not</i> reset.
	Resume	Resumes the application after it was suspended (manually, breakpoint, signal).
	Suspend	Suspends the application (pause). Use the Resume button to continue.
	Relaunch	Right-click menu. Restarts the selected debug session when it was terminated. If the debug session is still running, a new debug session is launched.
	Reload current application	Reloads the current application without restarting the debug session. The application does restart of course.
	Terminate	Ends the selected debug session and/or process. Use Relaunch to restart this debug session, or start another debug session.
	Terminate all	Right-click menu. As terminate. Ends <i>all</i> debug sessions.
	Terminate and remove	Right-click menu. Ends the debug session and removes it from the Debug view.

Icon	Action	Description
	Terminate and Relaunch	Right-click menu. Ends the debug session and relaunches it. This is the same as choosing Terminate and then Relaunch.
	Disconnect	Detaches the debugger from the selected process (useful for debugging attached processes).

Stepping through the application

Icon	Action	Description
	Step into	Steps to the next source line or instruction.
	Step over	Steps over a called function. The function is executed and the application suspends at the next instruction after the call.
	Step return	Executes the current function. The application suspends at the next instruction after the return of the function.
	Instruction stepping	Toggle. If enabled, the stepping functions are performed on instruction level instead of on C source line level.
	Interrupt aware stepping	Toggle. If enabled, the stepping functions do not step into an interrupt when it occurs.

Miscellaneous

Icon	Action	Description
	Copy Stack	Right-click menu. Copies the stack as text to the windows clipboard. You can paste the copied selection as text in, for example, a text editor.
	Edit <i>project...</i>	Right-click menu. Opens the debug configuration dialog to let you edit the current debug configuration.
	Edit Source Lookup...	Right-click menu. Opens the Edit Source Lookup Path window to let you edit the search path for locating source files.

10.4.2. Breakpoints View

You can add, disable and remove breakpoints by clicking in the marker bar (left margin) of the Editor view. This is explained in the Getting Started manual.

Description

The Breakpoints view shows a list of breakpoints that are currently set. The button bar in the Breakpoints view gives access to several common functions. The right-most button  opens the Breakpoints menu.

Types of breakpoints

To access the breakpoints dialog, add a breakpoint as follows:

1. Click the **Add TASKING Breakpoint** button (.

The Breakpoints dialog appears.

Each tab lets you set a breakpoint of a special type. You can set the following types of breakpoints:

- **File breakpoint**

The target halts when it reaches the specified line of the specified source file. Note that it is possible that a source line corresponds to multiple addresses, for example when a header file has been included into two different source files or when inlining has occurred. If so, the breakpoint will be associated with all those addresses.

- **Function**

The target halts when it reaches the first line of the specified function. If no source file has been specified and there are multiple functions with the given name, the target halts on all of those. Note that function breakpoints generally will not work on inlined instances of a function.

- **Address**

The target halts when it reaches the specified instruction address.

- **Stack**

The target halts when it reaches the specified stack level.

- **Data**

The target halts when the given variable or memory location (specified in terms of an absolute address) is read or written to, as specified.

- **Instruction**

The target halts when the given number of instructions has been executed.

- **Cycle**

The target halts when the given number of clock cycles has elapsed.

- **Timer**

The target halts when the given amount of time elapsed.

In addition to the type of the breakpoint, you can specify the condition that must be met to halt the program.

In the **Condition** field, type a condition. The condition is an expression which evaluates to 'true' (non-zero) or 'false' (zero). The program only halts on the breakpoint if the condition evaluates to 'true'.

In the **Ignore count** field, you can specify the number of times the breakpoint is ignored before the program halts. For example, if you want the program to halt only in the fifth iteration of a while-loop, type '4': the first four iterations are ignored.

10.4.3. File System Simulation (FSS) View

Description

The File System Simulation (FSS) view is automatically opened when the target requests FSS input or generates FSS output. The virtual terminal that the FSS view represents, follows the VT100 standard. If you right-click in the view area of the FSS view, a menu is presented which gives access to some self-explanatory functions.

VT100 characteristics

The `queens` example demonstrates some of the VT100 features. (You can find the `queens` example in the `<ARM installation path>\examples` directory from where you can import it into your workspace.) Per debugging session, you can have more than one FSS view, each of which is associated with a positive integer. By default, the view "FSS #1" is associated with the standard streams `stdin`, `stdout`, `stderr` and `stdaux`. Other views can be accessed by opening a file named "terminal window <number>", as shown in the example below.

```
FILE * f3 = fopen("terminal window 3", "rw");
fprintf(f3, "Hello, window 3.\n");
fclose(f3);
```

You can set the initial working directory of the target application in the Debug configuration dialog (see also [Section 10.2, *Creating a Customized Debug Configuration*](#)):

1. On the **Debugger** tab, select the **Miscellaneous** sub-tab.
2. In the **FSS root directory** field, specify the FSS root directory.

The FSS implementation is designed to work without user intervention. Nevertheless, there are some aspects that you need to be aware of.

First, the interaction between the C library code (in the files `dbg*.c` and `dbg*.h`; see [Section 14.2.4, *dbg.h*](#)) and the debugger takes place via a breakpoint, which incidentally is not shown in the Breakpoints view. Depending on the situation this may be a hardware breakpoint, which may be in short supply.

Secondly, proper operation requires certain code in the C library to have debug information. This debug information should normally be present but might get lost when this information is stripped later in the development process.

10.4.4. Disassembly View

The Disassembly view shows target memory disassembled into instructions and / or data. If possible, the associated C / C++ source code is shown as well. The **Address** field shows the address of the current selected line of code.

To view the contents of a specific memory location, type the address in the **Address** field. If the address is invalid, the field turns red.

10.4.5. Expressions View

The Expressions view allows you to evaluate and watch regular C expressions.

To add an expression:

Click **OK** to add the expression.

1. Right-click in the Expressions View and select **Add Watch Expression**.

The Add Watch Expression dialog appears.

2. Enter an expression you want to watch during debugging, for example, the variable name "i"

If you have added one or more expressions to watch, the right-click menu provides options to **Remove** and **Edit** or **Enable** and **Disable** added expressions.

- You can access target registers directly using #NAME. For example "arr[#R0 << 3]" or "#TIMER3 = m++". If a register is memory-mapped, you can also take its address, for example, "&#ADCIN".
- Expressions may contain target function calls like for example "g1 + invert(&g2)". Be aware that this will not work if the compiler has optimized the code in such a way that the original function code does not actually exist anymore. This may be the case, for example, as a result of inlining. Also, be aware that the function and its callees use the same stack(s) as your application, which may cause problems if there is too little stack space. Finally, any breakpoints present affect the invoked code in the normal way.

10.4.6. Memory View

Use the Memory view to inspect and change process memory. The Memory view supports the same addressing as the C and C++ languages. You can address memory using expressions such as:

- 0x0847d3c
- (&y)+1024
- *ptr

Monitors

To monitor process memory, you need to add a *monitor*:

1. In the Debug view, select a debug session. Selecting a thread or stack frame automatically selects the associated session.
2. Click the **Add Memory Monitor** button in the Memory Monitors pane.

The Monitor Memory dialog appears.

3. Type the address or expression that specifies the memory section you want to monitor and click **OK**.

TASKING VX-toolset for ARM User Guide

The monitor appears in the monitor list and the Memory Renderings pane displays the contents of memory locations beginning at the specified address.

To remove a monitor:

1. In the Monitors pane, right-click on a monitor.
2. From the popup menu, select **Remove Memory Monitor**.

Renderings

You can inspect the memory in so-called *renderings*. A rendering specifies how the output is displayed: hexadecimal, ASCII, signed integer, unsigned integer or traditional. You can add or remove renderings per monitor. Though you cannot change a rendering, you can add or remove them:

1. Click the **New Renderings...** tab in the Memory Renderings pane.

The Add Memory Rendering dialog appears.

2. Select the rendering you want (**Hex Integer**, **Hex**, **ASCII**, **Signed Integer**, **Unsigned Integer** or **Traditional**) and click **Add Rendering(s)**.

To remove a rendering:

1. Right-click on a memory address in the rendering.
2. From the popup menu, select **Remove Rendering**.

Changing memory contents

In a rendering you can change the memory contents. Simply type a new value.

Warning: Changing process memory can cause a program to crash.

The right-click popup menu gives some more options for changing the memory contents or to change the layout of the memory representation.

10.4.7. Compare Application View

You can use the Compare Application view to check if the downloaded application matches the application in memory. Differences may occur, for example, if you changed memory addresses in the Memory view.

- To check for differences, click the **Compare** button.

10.4.8. Heap View

With the Heap view you can inspect the status of the heap memory. This can be illustrated with the following example:

```
char * string = (char *) calloc(100, sizeof(char*));
strcpy ( string, "abcdefgh" );
free (string);
```

If you step through these lines during debugging, the Heap view shows the situation after each line has been executed. Before any of these lines has been executed, there is no memory allocated and the Heap view is empty.

- After the first line the Heap view shows that memory is occupied, the description tells where the block starts, how large it is (100 MAUs) and what its content is (0x0, 0x0, ...).
- After the second line, "abcdefgh" has been copied to the allocated block of memory. The description field of the Heap view again shows the actual contents of the memory block (0x61, 0x62, ...).
- The third line frees the memory. The Heap view is empty again because after this line no memory is allocated anymore.

10.4.9. Logging View

Use the Logging view to control the generation of internal log files. This view is intended mainly for use by or at the request of Altium support personnel.

10.4.10. RTOS View

The debugger has special support for debugging real-time operating systems (RTOSs). This support is implemented in an RTOS-specific shared library called a *kernel support module* (KSM) or *RTOS-aware debugging module* (RADM). Specifically, the TASKING VX-toolset for ARM ships with a KSM supporting the OSEK standard. You have to create your own OSEK Run Time Interface (ORTI) and specify this file on the **Miscellaneous** tab while configuring a customized debug configuration (see also [Section 10.2, Creating a Customized Debug Configuration](#)):

1. From the **Debug** menu, select **Debug Configurations...**
The Debug Configurations dialog appears.
2. In the left pane, select the configuration you want to change, for example, **TASKING C/C++ Debugger » myproject**.
Or: click the **New launch configuration** button () to add a new configuration.
3. Open the **Miscellaneous** tab
4. In the **ORTI file** field, specify the name of your own ORTI file.
5. If you want to use the supplied KSM suitable for OSEK kernels, in the **KSM module** field browse for the file `osek_radm.dll` in the `bin` directory of the toolset.

The debugger supports ORTI specifications v2.0 and v2.1.

10.4.11. Registers View

In the Registers view you can examine the value of registers while stepping through your application. The registers are organized in a number of *register groups*, which together contain all known registers. You can select a group to see which registers it contains. This view has a number of features:

- While you step through the application, the registers involved in the step turn yellow. If you scroll in the view or switch groups, some registers may appear on a lighter yellow background, indicating that the debugger does not know whether the registers have changed because the debugger did not read the registers before the step began.

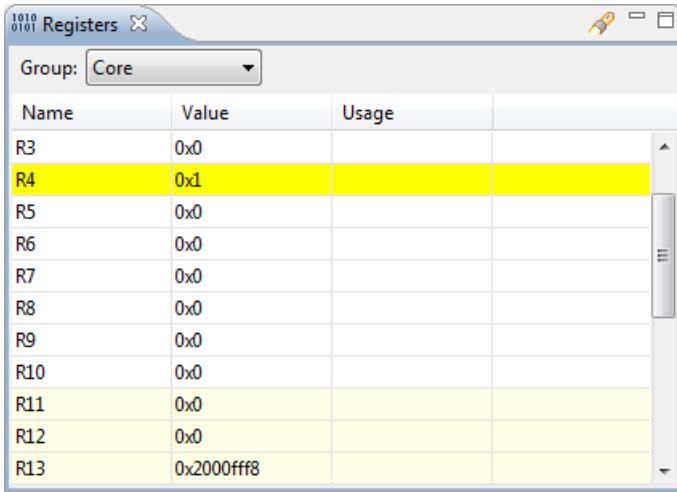

- You can change each register's value.
- For some registers the menu entry **Symbolic Representation** is available in their right-click popup menu. This opens a new view which shows the internal fields of the register. (Alternatively, you can double-click on a register). For example, the XPSR register from the Core group may be shown as follows:

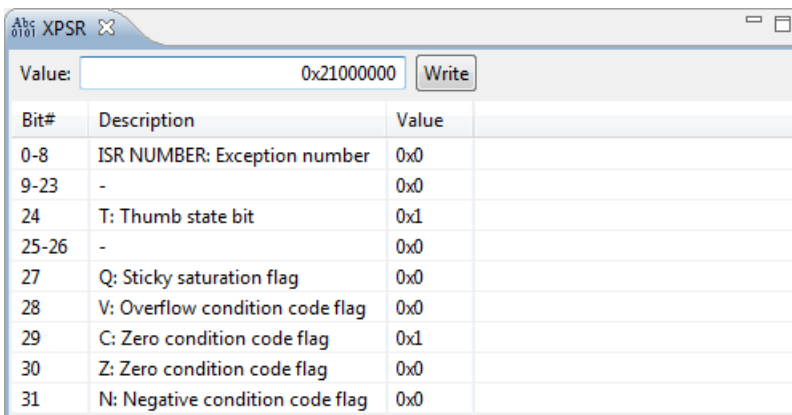

In this view you can set the individual values in the register, either by selecting a value from a drop-down box or by simply entering a value depending on the chosen field. To update the register with the new values, click the **Write** button.

- You can search for a specific register: right-click on a register and from the popup menu select **Find Register...** Enter a group or register name filter, click the register you want to see and click **OK**. The register of your interest will be shown in the view.

10.4.12. Trace View

If tracing is enabled, the Trace view shows the code was most recently executed. For example, while you step through the application, the Trace view shows the executed code of each step. To enable tracing:

- Right-click in the Trace view and select **Trace**.

A check mark appears when tracing is enabled.

The view has three tabs, **Source**, **Instruction** and **Raw**, each of which represents the trace in a different way. However, not all target environments will support all three of these. The view is updated automatically each time the target halts.

When you use the simulator, this works as is. Otherwise, for Cortex-M0+ devices, tracing only works when the processor has a Micro Trace Buffer (MTB). See [Section 10.4.12.1, Micro Trace Buffer Support](#). For M3 devices and up, tracing only works when the processor has a Trace Port Interface Unit (TPIU) and this is supported. See [Section 10.4.12.2, Trace Port Interface Unit Support](#).

When tracing is enabled note the following:

- If the condition associated with a conditional instruction was false, the instruction will still be shown in the trace, with no distinct visual indication. This applies to conditional branches, but also to instructions inside an IT block, for example.
- If the target halted due to a software breakpoint, then technically a BKPT instruction was executed and hence traced. However, for convenience this will not actually be shown in the Trace view.
- For bandwidth and performance reasons, the trace shown may be shorter than what would be expected considering the amount of data the debug probe can provide.
- The **Raw** tab shows the trace in its compressed form, i.e. as MTB packets (Cortex-M0+) or as a data stream compliant with the Embedded Trace Macrocell (ETM) signal protocol as defined by ARM Ltd. (Cortex-M3 and up). Usually, you will not need this information, but it may be useful if you suspect problems with the target communication or the decompression.

10.4.12.1. Micro Trace Buffer Support

The Micro Trace Buffer (MTB) stores the data packets that it generates within the processor's own SRAM, from where the debugger reads it every time the processor halts. You therefore need to reserve space for this data when you build your project. You can do this by defining the LSL macro `__MTB_SIZE` (see [linker option --define](#)), which defines the size in bytes. The value must be a power of 2 and at least 32. Be aware that because of how the hardware works, the start address of the reserved space needs to be a multiple of `__MTB_SIZE`, but the linker takes care of this automatically.

The larger the value of `__MTB_SIZE`, the longer and hence the more useful the trace will be. There is no exact relationship between the macro's value and the number of instructions traced, however, because it depends on the kind of code being executed.

10.4.12.2. Trace Port Interface Unit Support

Many modern ARM-based processors have a Trace Port Interface Unit (TPIU), which provides a means to communicate trace and other debug related information to a suitable debug probe, such as a SEGGER J-Trace.

Currently, the TASKING debugger can process TPIU output only for STMicroelectronics STM32F processors and only in conjunction with a SEGGER J-Trace probe. Note that not all evaluation boards actually allow connecting a J-Trace.

You need to be aware of the following:

- The TPIU data is output via five pins named TRACECK and TRACED0...3 or similar. Typically, these pins are shared with other chip peripherals and hence you must take care not to use these pins for other purposes while using TPIU-related debug facilities.
- At the moment, the TPIU is used only for tracing purposes (see [Section 10.4.12, Trace View](#)). In this case especially the amount of TPIU data is relatively large and therefore, it is important that the TPIU output frequency is large enough relative to the core's, because otherwise overflow may occur. The default settings are such that no overflow will occur, but if you increase the core clock frequency, it is recommended that you increase the TPIU output frequency by the same factor.

If overflow does occur, the debugger will try to detect and/or work around it, but this may not always succeed. This may manifest itself as a trace which is inconsistent with actual program execution, for example.

10.5. Programming a Flash Device

With the TASKING debugger you can download an application file to flash memory. Before you download the file, you must specify the type of flash devices you use in your system and the address range(s) used by these devices.

To program a flash device the debugger needs to download a flash programming monitor to the target to execute the flash programming algorithm (target-target communication). This method uses temporary target memory to store the flash programming monitor and you have to specify a temporary data workspace for interaction between the debugger and the flash programming monitor.

Two types of flash devices can exist: on-chip flash devices and external flash devices.

Setup an on-chip flash device

When you specify a target configuration board using the New C/C++ wizard, as explained in the Getting Started manual, any on-chip flash devices are setup automatically.

Setup an external flash device

1. From the **Project** menu, select **Properties for**

The Properties for project dialog appears.

2. In the left pane, expand **Run/Debug Settings** and select **Flash Programming**.

The Flash Programming pane appears.

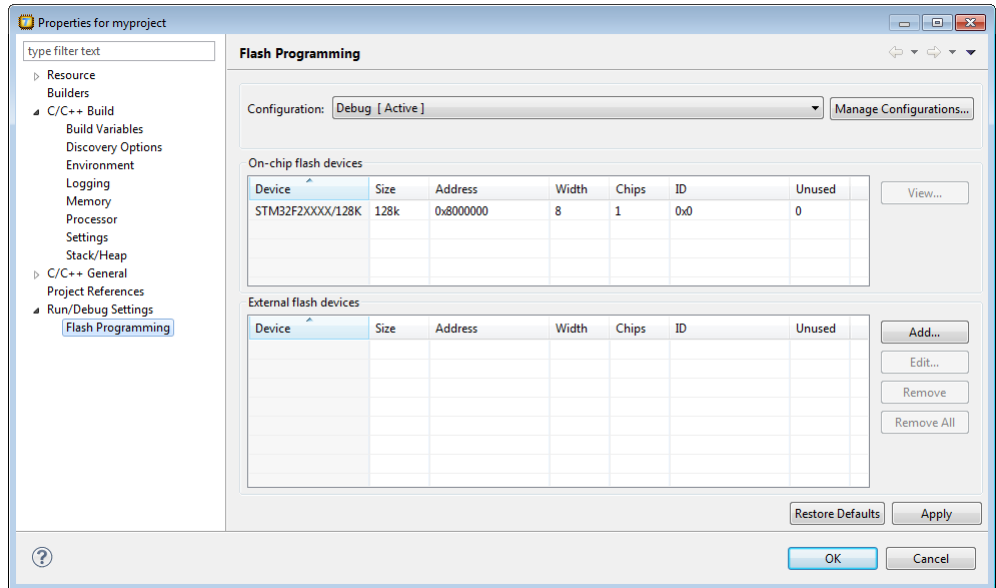

3. Click **Add...** to specify an external flash device.

The Select a New Flash Device dialog appears.

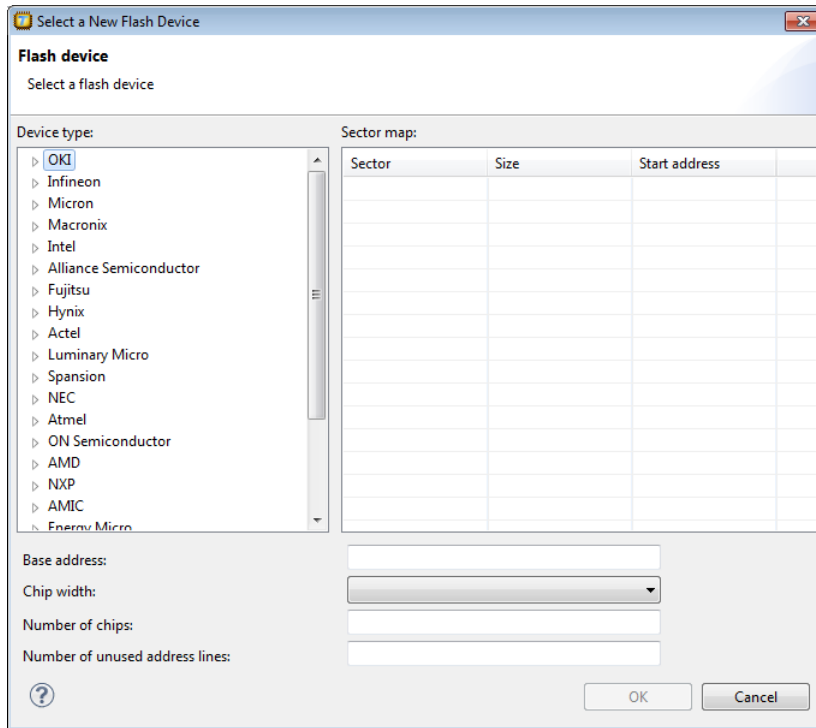

4. In the **Device type** box, expand the name of the manufacturer of the device and select a device.

The Sector map displays the memory layout of the flash device(s). Each sector has a size and

5. In the **Base address** field enter the start address of the memory range that will be covered by the flash device. Any following addresses separated by commas are considered mirror addresses. This allows the flash device to be programmed through its mirror address before switching the flash to its base address.
6. In the **Chip width** field select the width of the flash device.
7. In the **Number of chips** field, enter the number of flash devices that are located in parallel. For example, if you have two 8-bit devices in parallel attached to a 16-bit data bus, enter 2.
8. Fill in the **Number of unused address lines** field, if necessary.

The flash memory is added to the linker script file automatically with the tag "flash=flash-id".

To program a flash device

1. From the **Debug** menu, select **Debug Configurations...**

The Debug Configurations dialog appears.

2. In the left pane, select the configuration you want to change, for example, **TASKING C/C++ Debugger » myproject.board**.
3. On the **Debugger** tab, select the **Initialization** tab
4. Enable the option **Program flash when downloading**.

The Flash settings group box becomes active.

5. In the **Monitor file** field, specify the filename of the flash programming monitor, usually an Intel Hex or S-Record file.
6. In the **Sector buffer size** field, specify the buffer size for buffering a flash sector.
7. Specify the data **Workspace address** used by the flash programming monitor. This address may not conflict with the addresses of the flash devices.
8. Click **Debug** to program the flash device and start debugging.

Chapter 11. Tool Options

This chapter provides a detailed description of the options for the compiler, assembler, linker, control program, make utility and the archiver.

Tool options in Eclipse (Menu entry)

For each tool option that you can set from within Eclipse, a **Menu entry** description is available. In Eclipse you can customize the tools and tool options in the following dialog:

1. From the **Project** menu, select **Properties for**
The Properties dialog appears.
2. In the left pane, expand **C/C++ Build** and select **Settings**.
In the right pane the Settings appear.
3. Open the **Tool Settings** tab.
You can set all tool options here.

Unless stated otherwise, all **Menu entry** descriptions expect that you have this Tool Settings tab open.

The following tables give an overview of all tool options on the Tool Settings tab in Eclipse with hyperlinks to the corresponding command line options (if available).

Global Options

Eclipse option	Description or option
Use global 'product directory' preference	Directory where the TASKING toolset is installed
Treat warnings as errors	Control program option --warnings-as-errors
Keep temporary files	Control program option --keep-temporary-files (-t)
Verbose mode of control program	Control program option --verbose (-v)
Endianness	Control program option --endianness

C/C++ Compiler

Eclipse option	Description or option
Preprocessing	
Include CMSIS device register definition header file	C compiler option --include-file

Eclipse option	Description or option
Store preprocessor output in <file>.pre	Control program option --preprocess (-E) / --no-preprocessing-only
Keep comments in preprocessor output	Control program option --preprocess=+comments
Keep #line info in preprocessor output	Control program option --preprocess=-noline
Defined symbols	C compiler option --define
Pre-include files	C compiler option --include-file
Include Paths	
Add CMSIS include paths	C compiler option --include-directory
Include paths	C compiler option --include-directory
Precompiled C++ Headers	
Automatically use/create precompiled header file	C++ compiler option --pch
Create precompiled header file	C++ compiler option --create-pch
Use precompiled header file	C++ compiler option --use-pch
Precompiled header file directory	C++ compiler option --pch-dir
Language	
Comply to C standard	C compiler option --iso
Allow GNU C extensions	C compiler option --language=+gcc
Allow // comments in ISO C90 mode	C compiler option --language=+comments
Check assignment of string literal to non-'const' string pointer	C compiler option --language=-strings
Treat 'char' variables as unsigned	C compiler option --uchar
Treat 'double' as 'float'	C compiler option --no-double
Allow optimization across volatile access	C compiler option --language=-volatile
Allow Shift JIS Kanji in strings	C compiler option --language=+kanji
Comply to embedded C++ subset	C++ compiler option --embedded-c++
Support for C++ I/O streams	C++ compiler option --io-streams
Support for C++ exception handling	C++ compiler option --exceptions
Support for C++ RTTI (run-time type information)	C++ compiler option --rtti
Allow the 'wchar_t' keyword (C++)	C++ compiler option --wchar_t-keyword
Allow non-ANSI/ISO C++ features	C++ compiler option --strict
C++ anachronisms	C++ compiler option --anachronisms
Allow GNU C++ extensions	C++ compiler option --g++
Code Generation	
Use Thumb instruction set	C compiler option --thumb

Eclipse option	Description or option
Compile for ARM/Thumb interworking	C compiler option --interwork
Use FPU	C compiler option --fpu
Alignment for composite types	C compiler option --align-composites
Select call mode	C compiler option --call
Optimization	
Optimization level	C compiler option --optimize
Trade-off between speed and size	C compiler option --tradeoff
Maximum size for code compaction	C compiler option --compact-max-size
Maximum call depth for code compaction	C compiler option --max-call-depth
Always inline function calls	C compiler option --inline
Maximum size increment when inlining (in %)	C compiler option --inline-max-incr
Maximum size for functions to always inline	C compiler option --inline-max-size
Build for application wide optimizations (MIL linking)	Control program option --mil-link / --mil-split
Application wide optimization mode	Control program option --mil-link / --mil-split
Custom Optimization	C compiler option --optimize
Compilation Speed	C compiler option --cache
Debugging	
Generate symbolic debug information	C compiler option --debug-info
Static profiling	C compiler option --profile=+static
Generate profiling information for block counters	C compiler option --profile=+block
Generate profiling information to build a call graph	C compiler option --profile=+callgraph
Generate profiling information for function counters	C compiler option --profile=+function
Generate profiling information for function timers	C compiler option --profile=+time
Exclude time spent in interrupt functions	C compiler option --profile=+time,+interrupt
Generate code for bounds checking	C compiler option --runtime=+bounds
Generate code to detect unhandled case in a switch	C compiler option --runtime=+case
Generate code for malloc consistency checks	C compiler option --runtime=+malloc
Generate code for stack overflow checks (allowed for USR and SYS mode only)	C compiler option --runtime=+stack
Generate code for division by zero checks	C compiler option --runtime=+zero
MISRA C	
MISRA C checking	C compiler option --misrac
MISRA C version	C compiler option --misrac-version
Warnings instead of errors for mandatory rules	C compiler option --misrac-mandatory-warnings

Eclipse option	Description or option
Warnings instead of errors for required rules	C compiler option --misrac-required-warnings
Warnings instead of errors for advisory rules	C compiler option --misrac-advisory-warnings
Custom 1998 / Custom 2004 / Custom 2012	C compiler option --misrac
CERT C Secure Coding	
CERT C secure code checking	C compiler option --cert
Warnings instead of errors	C compiler option --warnings-as-errors=700-715
Custom CERT C	C compiler option --cert
Diagnostics	
Suppress C compiler warnings	C compiler option --no-warnings=num
Suppress all warnings	C compiler option --no-warnings
Suppress C++ compiler “used before set” warnings	C++ compiler option --no-use-before-set-warnings
Issue remarks on C++ code	C++ compiler option --remarks
Perform global type checking on C code	C compiler option --global-type-checking
Miscellaneous	
Merge C source code with generated assembly	C compiler option --source
Force definition of virtual function tables (C++)	C++ compiler option --force-vtbl
Suppress definition of virtual function tables (C++)	C++ compiler option --suppress-vtbl
Implicit inclusion of source files for finding templates	C++ compiler option --implicit-include
Minimal inlining of function calls (C++)	C++ compiler option --no-inlining
Instantiation mode of external template entities	C++ compiler option --instantiate
Generated options	C compiler options, Control program options
Additional options	C compiler options, C++ compiler options, Control program options

Assembler

Eclipse option	Description or option
Preprocessing	
Use TASKING preprocessor	Assembler option --preprocessor-type
Defined symbols	Assembler option --define
Pre-include files	Assembler option --include-file
Include Paths	
Include paths	Assembler option --include-directory

Eclipse option	Description or option
Symbols	
Generate symbolic debug	Assembler option --debug-info
Case insensitive identifiers	Assembler option --case-insensitive
Emit local EQU symbols	Assembler option --emit-locals=+equ
Emit mapping symbols (\$a,\$t,\$d)	Assembler option --emit-locals=+mappings
Emit local non-EQU symbols	Assembler option --emit-locals=+symbols
Set default symbol scope to global	Assembler option --symbol-scope
List File	
Generate list file	Control program option --list-files
List ...	Assembler option --list-format
List section summary	Assembler option --section-info=+list
Diagnostics	
Suppress warnings	Assembler option --no-warnings=num
Suppress all warnings	Assembler option --no-warnings
Display section summary	Assembler option --section-info=+console
Maximum number of emitted errors	Assembler option --error-limit
Miscellaneous	
Use full assembler for mixed ARM and Thumb instructions	Control program option --mixed-arm-thumb
Assemble Thumb instructions by default	Control program option --thumb
Allow 2-operand form for 3-operand instructions	Assembler option --relaxed
UAL syntax mode	Assembler option --old-syntax
Allow instruction inversions	Assembler option --inversions
Allow Shift JIS Kanji in strings	Assembler option --kanji
Additional options	Assembler options

Linker

Eclipse option	Description or option
Output Format	
Generate Intel Hex format file	Linker option --output=file:IHEX
Generate S-records file	Linker option --output=file:SREC
Create file for each memory chip	Linker option --chip-output
Size of addresses (in bytes) for Intel Hex records	Linker option --output=file:IHEX:size
Size of addresses (in bytes) for Motorola S records	Linker option --output=file:SREC:size
Emit start address record	Linker option --hex-format=s
Libraries	

Eclipse option	Description or option
Link default libraries	Control program option --no-default-libraries
Link CMSIS DSP library	Control program option --dsp-library
Rescan libraries to solve unresolved externals	Linker option --no-rescan
Libraries	The libraries are added as files on the command line.
Library search path	Linker option --library-directory
Data Objects	
Data objects	Linker option --import-object
Script File	
Defined symbols	Linker option --define
Linker script file (.lsl)	Linker option --lsl-file
Optimization	
Delete unreferenced sections	Linker option --optimize=c
Use a 'first-fit decreasing' algorithm	Linker option --optimize=l
Compress copy table	Linker option --optimize=t
Delete duplicate code	Linker option --optimize=x
Delete duplicate data	Linker option --optimize=y
Compress ROM sections of copy table items	Linker option --optimize=z
Map File	
Generate map file (.map)	Control program option --no-map-file
Generate XML map file format (.mapxml) for map file viewer	Linker option --map-file=file.mapxml:XML
Include ...	Linker option --map-file-format
Diagnostics	
Suppress warnings	Linker option --no-warnings=num
Suppress all warnings	Linker option --no-warnings
Maximum number of emitted errors	Linker option --error-limit
Miscellaneous	
Strip symbolic debug information	Linker option --strip-debug
Link case insensitive	Linker option --case-insensitive
Do not use standard copy table for initialization	Linker option --user-provided-initialization-code
Show link phases during processing	Linker option --verbose
Generate long-branch veneers	Linker option --long-branch-veneers
Application is not romable	Linker option --non-romable
Additional options	Linker options

11.1. Configuring the Command Line Environment

If you want to use the tools on the command line (using a Command Prompt), you can set *environment variables*.

You can set the following environment variables:

Environment variable	Description
ASARMINC	With this variable you specify one or more additional directories in which the assembler looks for include files. See Section 6.4, How the Assembler Searches Include Files .
CARMINC	With this variable you specify one or more additional directories in which the C compiler looks for include files. See Section 4.3, How the Compiler Searches Include Files .
CPARMINC	With this variable you specify one or more additional directories in which the C++ compiler looks for include files. See Section 5.2, How the C++ Compiler Searches Include Files .
CCARMBIN	When this variable is set, the control program prepends the directory specified by this variable to the names of the tools invoked.
LIBCARM	With this variable you specify one or more additional directories in which the linker looks for libraries. See Section 7.3.1, How the Linker Searches Libraries .
PATH	With this variable you specify the directory in which the executables reside. This allows you to call the executables when you are not in the <code>bin</code> directory. Usually your system already uses the <code>PATH</code> variable for other purposes. To keep these settings, you need to add (rather than replace) the path. Use a semicolon (;) to separate path names.
TMPDIR	With this variable you specify the location where programs can create temporary files. Usually your system already uses this variable. In this case you do not need to change it.

See the documentation of your operating system on how to set environment variables.

11.2. C Compiler Options

This section lists all C compiler options.

Options in Eclipse versus options on the command line

Most command line options have an equivalent option in Eclipse but some options are only available on the command line. Eclipse invokes the compiler via the control program. Therefore, it uses the syntax of the control program to pass options and files to the C compiler. If there is no equivalent option in Eclipse, you can specify a command line option in Eclipse as follows:

1. From the **Project** menu, select **Properties for**

The Properties dialog appears.

2. In the left pane, expand **C/C++ Build** and select **Settings**.

In the right pane the Settings appear.

3. On the Tool Settings tab, select **C/C++ Compiler » Miscellaneous**.

4. In the **Additional options** field, enter one or more command line options.

*Because Eclipse uses the control program, you have to precede the option with **-Wc** to pass the option via the control program directly to the C compiler.*

Be aware that some command line options are not useful in Eclipse or just do not have any effect. For example, the option **-n** sends output to stdout instead of a file and has no effect in Eclipse.

Short and long option names

Options can have both short and long names. Short option names always begin with a single minus (-) character, long option names always begin with two minus (--) characters. You can abbreviate long option names as long as it forms a unique name. You can mix short and long option names on the command line.

Options can have flags or suboptions. To switch a flag 'on', use a lowercase letter or a **+longflag**. To switch a flag off, use an uppercase letter or a **-longflag**. Separate **longflags** with commas. The following two invocations are equivalent:

```
carm -Oac test.c  
carm --optimize=+coalesce,+cse test.c
```

When you do not specify an option, a default value may become active.

C compiler option: `--align-composites`

Menu entry

1. Select **C/C++ Compiler » Code Generation**.
2. Select the **Alignment for composite types: Natural alignment** or **Optimal alignment**.

Command line syntax

`--align-composites=alignment`

You can specify the following alignments:

n	Natural alignment (default)
o	Optimal alignment

Description

With this option you can set the alignment for composite types (structs, unions and arrays).

Natural alignment (**n**) uses the natural alignment of the most-aligned member of the composite type.

Optimal alignment (**o**) sets the alignment to 8, 16, or 32 bits depending on the size of the composite type.

Example

Consider the following structure of three chars.

```
struct s
{
    char a;
    char b;
    char c;
} s_var;
```

With natural alignment this results in a size of `s_var` of three bytes.

```
s_var .type object
      .size s_var,3
      .ds 3
```

With `--align-composites=o`, `s_var` is padded with one extra byte, so that the contents of the struct is aligned at 4 bytes.

```
s_var .type object
      .size s_var,4
      .ds 4
```

Related information

-

C compiler option: `--cache`

Menu entry

1. Select **C/C++ Compiler » Optimization » Compilation Speed**.
2. Enable the option **Cache generated code to improve the compilation speed**.
3. In the **Directory for cached files** field, enter the name for the location of the cache.

Command line syntax

`--cache[=directory]`

Default on command line: `.` (current directory)

Default in Eclipse: `.cache` directory under project directory

Description

This option enables a cache for output files in the specified *directory*. When the source code after preprocessing and relevant compiler options and the compiler version are the same as in a previous invocation, the previous result is copied to the output file. The cache only works when there is a single C input file and a single output file (no `--mil-split`).

You can also enable the cache and specify the cache directory with the environment variable `CARMCACHE`. This option takes precedence over the environment variable.

The cache directory may be shared, for instance by placing it on a network drive.

The compiler creates a directory `carmcache` in the directory specified with the option `--cache` or the environment variable `CARMCACHE`. The directory is only created when it does not yet exist. The cache files are stored in this directory.

Example

To improve the compilation speed and put cached files in directory `.cache`, enter:

```
carm --cache=.cache test.c
```

Related information

[Section 12.5, *Compiler Cache*](#)

[Section 9.6, *Expire Cache Utility*](#)

C compiler option: --call (-m)

Menu entry

1. Select **C/C++ Compiler » Code Generation**.
2. Set the option **Select call mode** to **Use PC-relative calls** (default) or to **Use 32-bit indirect calls**.

Command line syntax

```
--call={far|near}
```

```
-m{f|n}
```

Description

To address the memory of the ARM, you can use two different call modes:

far	32-bit indirect calls. Though you can address the full range of memory, the address is first loaded into a register after which the call is executed.
near	26-bit PC-relative call. The PC-relative call is directly coded into the B instruction. This way of calling results in higher execution speed. However, not the full range of memory can be addressed with near calls.

If you compile your C source with near calls but the called address cannot be reached with a near call, the *linker* will generate an error.

It is recommended to use the near addressing mode unless your application needs calls to addresses that fall outside a 256 MB region.

Instead of using this option, it is recommended to use the [linker option --long-branch-veneers](#). This linker option only adds long branch veneers where necessary.

Example

Consider the following function `q` which calls function `p`:

```
extern int p(int a, int b, int c, int d)
{
    return a+b+c+d + a*b*c*d;
}

extern int iii;
void q(void)
{
    iii=p(42,43,44,45);
}
```

With `--call=near`, this results into

```
q:    .type    func

      str     lr,[sp,#-4]!

      mov     r3,#45
      mov     r2,#44
      mov     r1,#43
      mov     r0,#42
      bl      p           ; PC-relative call
      ldr     r1,.L3
      str     r0,[r1,#0]
      ldr     pc,[sp],#4
      .align  4

.L3:

      .dw     iii
      .size   q,$-q

      .calls  'q','p'
      .calls  'p','','8
      .calls  'q','','4
      .extern iii
```

With `--call=far`, this results into

```
q:    .type    func

      stmfd   sp!,{r4,lr}

      ldr     r4,.L3      ; address loaded in register
      mov     r3,#45
      mov     r2,#44
      mov     r1,#43
      mov     r0,#42
      mov     lr,pc
      bx      r4         ; indirect call
      ldr     r1,.L3+4
      str     r0,[r1,#0]
      ldmfd   sp!,{r4,pc}
      .align  4

.L3:

      .dw     p
      .dw     iii
      .size   q,$-q

      .calls  '__INDIRECT__','p' ; indirect calls
      .calls  'q','__INDIRECT__'
      .calls  'p','','8
      .calls  'q','','8
```

TASKING VX-toolset for ARM User Guide

```
.extern iii  
.extern __INDIRECT__
```

Related information

Linker option **--long-branch-veneers**

C compiler option: `--cert`

Menu entry

1. Select **C/C++ Compiler » CERT C Secure Coding**.
2. Make a selection from the **CERT C secure code checking** list.
3. If you selected **Custom**, expand the **Custom CERT C** entry and enable one or more individual recommendations/rules.

Command line syntax

```
--cert={all | name [-name] , ... }
```

Default format: all

Description

With this option you can enable one or more checks for CERT C Secure Coding Standard recommendations/rules. When you omit the argument, all checks are enabled. *name* is the name of a CERT recommendation/rule, consisting of three letters and two digits. Specify only the three-letter mnemonic to select a whole category. For the list of names you can use, see [Chapter 20, CERT C Secure Coding Standard](#).

On the command line you can use `--diag=cert` to see a list of the available checks, or you can use a three-letter mnemonic to list only the checks in a particular category. For example, `--diag=pre` lists all supported preprocessor checks.

Example

To enable the check for CERT rule STR30-C, enter:

```
carc --cert=str30 test.c
```

Related information

[Chapter 20, CERT C Secure Coding Standard](#)

[C compiler option `--diag`](#) (Explanation of diagnostic messages)

C compiler option: --check

Menu entry

-

Command line syntax

`--check`

Description

With this option you can check the source code for syntax errors, without generating code. This saves time in developing your application because the code will not actually be compiled.

The compiler reports any warnings and/or errors.

This option is available on the command line only.

Related information

Assembler option `--check` (Check syntax)

C compiler option: `--code-endianness`

Menu entry

-

Command line syntax

```
--code-endianness=endianness
```

You can specify the following *endianness*:

big	b	Big endian
little	l	Little endian (default)

Description

This option tells the compiler what code endianness you want, little-endian (least significant byte of a word at lowest byte code address) or big-endian (most significant byte of a word at lowest byte code address). The code endianness used must be a valid one for the architecture you are compiling for. This option is only available for ARMv7R.

Related information

C compiler option `--endianness` (Data endianness)

C compiler option: `--compact-max-size`

Menu entry

1. Select **C/C++ Compiler » Optimization**.
2. In the **Maximum size for code compaction** field, enter the maximum size of a match.

Command line syntax

`--compact-max-size=value`

Default: 200

Description

This option is related to the compiler optimization `--optimize=+compact` (Code compaction or reverse inlining). Code compaction is the opposite of inlining functions: large sequences of code that occur more than once, are transformed into a function. This reduces code size (possibly at the cost of execution speed).

However, in the process of finding sequences of matching instructions, compile time and compiler memory usage increase quadratically with the number of instructions considered for code compaction. With this option you tell the compiler to limit the number of matching instructions it considers for code compaction.

Example

To limit the maximum number of instructions in functions that the compiler generates during code compaction:

```
carm --optimize=+compact --compact-max-size=100 test.c
```

Related information

C compiler option `--optimize=+compact` (Optimization: code compaction)

C compiler option `--max-call-depth` (Maximum call depth for code compaction)

C compiler option: `--cpu (-C)`

Menu entry

1. Expand **C/C++ Build** and select **Processor**.
2. From the **Processor selection** list, make a selection by **Architecture**, **Core** or one of the manufacturers.

Command line syntax

`--cpu=architecture`

`-Carchitecture`

You can specify the following architectures:

ARMv6M	Compile for ARMv6-M architecture
ARMv7M	Compile for ARMv7-M architecture
ARMv7EM	Compile for ARMv7E-M architecture
ARMv7R	Compile for ARMv7-R architecture

Description

With this option you specify the ARM architecture for which you create your application. The ARM target supports more than one architecture and therefore you need to specify for which architecture the compiler should compile. The architecture determines which instructions are valid and which are not.

You choose one of the following architectures: ARMv6-M, ARMv7-M, ARMv7E-M or ARMv7-R. The compiler sets the Thumb instruction set implicitly (option `--thumb`).

The macro `__CPU_arch__` is defined in the C source file. The *arch* is converted to uppercase.

When you call the compiler from the command line, make sure you specify the same core type to the assembler to avoid conflicts!

Example

To compile the file `test.c` for the ARMv7E-M processor type, enter the following on the command line:

```
carm --cpu=ARMv7EM test.c
```

The compiler compiles for the chosen processor type.

Related information

Control program option `--cpu` (Select architecture)

Assembler option `--cpu` (Select architecture)

C compiler option: `--debug-info (-g)`

Menu entry

1. Select **C/C++ Compiler » Debugging**.
2. To **generate symbolic debug information**, select **Default**, **Small set** or **Full**.
To disable the generation of debug information, select **None**.

Command line syntax

`--debug-info[=suboption]`

`-g[suboption]`

You can set the following suboptions:

small	1 / c	Emit small set of debug information.
default	2 / d	Emit default symbolic debug information.
all	3 / a	Emit full symbolic debug information.

Default: `--debug-info` (same as `--debug-info=default`)

Description

With this option you tell the compiler to add directives to the output file for including symbolic information. This facilitates high level debugging but increases the size of the resulting assembler file (and thus the size of the object file). For the final application, compile your C files without debug information.

The DWARF debug format allows for a flexible approach as to how much symbolic information is included, as long as the structure is valid. Adding all possible DWARF data for a program is not practical. The amount of DWARF information per compilation unit can be huge. And for large projects, with many object modules the link time can grow unacceptably long. That is why the compiler has several debug information levels. In general terms one can say, the higher the level the more DWARF information is produced.

The DWARF data in an object module is not only used for debugging. The toolset can also do "type checking" of the whole application. In that case the linker will use the DWARF information of all object modules to determine if every use of a symbol is done with the same type. In other words, if the application is built with type checking enabled then the compiler will add DWARF information too.

Small set of debug information

With this suboption only DWARF call frame information and type information are generated. This enables you to inspect parameters of nested functions. The type information improves debugging. You can perform a stack trace, but stepping is not possible because debug information on function bodies is not generated. You can use this suboption, for example, to compact libraries.

Default debug information

This provides all debug information you need to debug your application. It meets the debugging requirements in most cases without resulting in oversized assembler/object files.

Full debug information

With this suboption extra debug information is generated about unused typedefs and DWARF "lookup table sections". Under normal circumstances this extra debug information is not needed to debug the program. Information about unused typedefs concerns all typedefs, even the ones that are not used for any variable in the program. (Possibly, these unused typedefs are listed in the standard include files.) With this suboption, the resulting assembler/object file will increase significantly.

In the following table you see in more detail what DWARF information is included for the debug option levels.

Feature	-g1	-g2	-g3	type check	Remarks
basic info	+	+	+	+	info such as symbol name and type
call frame	+	+	+	+	this is information for a debugger to compute a stack trace when a program has stopped at a breakpoint
symbol lifetime		+	+		this is information about where symbols live (e.g. on stack at offset so and so, when the program counter is in this range)
line number info		+	+	+	file name, line number, column number
"lookup tables"			+		DWARF sections ... this is an optimization for the DWARF data, it is not essential
unused typedefs			+		in the C/C++ code of the program there can be (many) typedefs that are not used for any variable. Sometimes this can cause enormous expansion of the DWARF data and thus it is only included in -g3 .

Related information

-

C compiler option: --define (-D)

Menu entry

1. Select **C/C++ Compiler » Preprocessing**.

The Defined symbols box shows the symbols that are currently defined.

2. To define a new symbol, click on the **Add** button in the **Defined symbols** box.
3. Type the symbol definition (for example, `demo=1`)

Use the **Edit** and **Delete** button to change a macro definition or to remove a macro from the list.

Command line syntax

```
--define=macro_name[=macro_definition]
```

```
-Dmacro_name[=macro_definition]
```

Description

With this option you can define a macro and specify it to the preprocessor. If you only specify a macro name (no macro definition), the macro expands as '1'.

You can specify as many macros as you like. Simply use the **Add** button to add new macro definitions.

On the command line, you can use the option **--define (-D)** multiple times. If the command line exceeds the limit of the operating system, you can define the macros in an option file which you then must specify to the compiler with the option **--option-file (-f) file**.

Defining macros with this option (instead of in the C source) is, for example, useful to compile conditional C source as shown in the example below.

Make sure you do not use a reserved keyword as a macro name, as this can lead to unexpected results.

Example

Consider the following C program with conditional code to compile a demo program and a real program:

```
void main( void )
{
#if DEMO
    demo_func(); /* compile for the demo program */
#else
    real_func(); /* compile for the real program */
#endif
}
```

You can now use a macro definition to set the DEMO flag:

```
carm --define=DEMO test.c
carm --define=DEMO=1 test.c
```

Note that both invocations have the same effect.

The next example shows how to define a macro with arguments. Note that the macro name and definition are placed between double quotes because otherwise the spaces would indicate a new option.

```
carm --define="MAX(A,B)=((A) > (B) ? (A) : (B))" test.c
```

Related information

[C compiler option `--undefine`](#) (Remove preprocessor macro)

[C compiler option `--option-file`](#) (Specify an option file)

C compiler option: `--dep-file`

Menu entry

Eclipse uses this option in the background to create a file with extension `.d` (one for every input file).

Command line syntax

```
--dep-file[=file]
```

Description

With this option you tell the compiler to generate dependency lines that can be used in a Makefile. In contrast to the option `--preprocess=+make`, the dependency information will be generated in addition to the normal output file.

By default, the information is written to a file with extension `.d` (one for every input file). When you specify a filename, all dependencies will be combined in the specified file.

Example

```
carm --dep-file=test.dep test.c
```

The compiler compiles the file `test.c`, which results in the output file `test.src`, and generates dependency lines in the file `test.dep`. For example:

```
test.obj :    test.c
test.c :
test.obj :    <install-dir>/carm/include/stdio.h
<install-dir>/carm/include/stdio.h :
test.obj :    <install-dir>/carm/include/stdarg.h
<install-dir>/carm/include/stdarg.h :
```

Related information

C compiler option `--preprocess=+make` (Generate dependencies for make)

C compiler option: `--diag`

Menu entry

1. From the **Window** menu, select **Show View » Other » TASKING » Problems**.

The Problems view is added to the current perspective.

2. In the Problems view right-click on a message.

A popup menu appears.

3. Select **Detailed Diagnostics Info**.

A dialog box appears with additional information.

Command line syntax

```
--diag=[format:]{all | msg[-msg],...}
```

You can set the following output formats:

html	HTML output.
rtf	Rich Text Format.
text	ASCII text.

Default format: text

Description

With this option you can ask for an extended description of error messages in the format you choose. The output is directed to stdout (normally your screen) and in the format you specify. The compiler does not compile any files. You can specify the following formats: **html**, **rtf** or **text** (default). To create a file with the descriptions, you must redirect the output.

With the suboption **all**, the descriptions of all error messages are given (except for the CERT checks). If you want the description of one or more selected error messages, you can specify the error message numbers, separated by commas, or you can specify a range.

With `--diag=cert` you can see a list of the available CERT checks, or you can use a three-letter mnemonic to list only the checks in a particular category. For example, `--diag=pre` lists all supported preprocessor checks.

Example

To display an explanation of message number 282, enter:

```
carm --diag=282
```

This results in the following message and explanation:

TASKING VX-toolset for ARM User Guide

E282: unterminated comment

Make sure that every comment starting with `/*` has a matching `*/`.
Nested comments are not possible.

To write an explanation of all errors and warnings in HTML format to file `cerrors.html`, use redirection and enter:

```
carm --diag=html:all > cerrors.html
```

Related information

[Section 4.7, *C Compiler Error Messages*](#)

C compiler option `--cert` (Enable individual CERT checks)

C compiler option: `--endianness`

Menu entry

1. Select **Global Options**.
2. Specify the **Endianness:Little-endian mode** or **Big-endian mode**.

Command line syntax

`--endianness=endianness`

`-B`

`--big-endian`

You can specify the following *endianness*:

big	b	Big endian
little	l	Little endian (default)

Description

By default, the compiler generates code for a little-endian target (least significant byte of a word at lowest byte address). With `--endianness=big` the compiler generates code for a big-endian target (most significant byte of a word at lowest byte address). `-B` is an alias for option `--endianness=big`.

Related information

C compiler option `--code-endianness` (Code endianness)

C compiler option: --error-file

Menu entry

-

Command line syntax

--error-file[=*file*]

Description

With this option the compiler redirects error messages to a file. If you do not specify a filename, the error file will be named after the output file with extension `.err`.

Example

To write errors to `errors.err` instead of `stderr`, enter:

```
carm --error-file=errors.err test.c
```

Related information

-

C compiler option: `--fp-model`

Menu entry

1. Select **C/C++ Compiler » Language**.
2. Enable the option **Treat 'double' as 'float'**.

Command line syntax

`--fp-model=flags`

You can set the following flags:

+/-float	f/F	treat 'double' as 'float'
+/-rewrite	r/R	allow expression rewriting
+/-negzero	z/Z	ignore sign of -0.0
	1	alias for <code>--fp-model=FRZ</code>
	2	alias for <code>--fp-model=Frz</code>
	3	alias for <code>--fp-model=frz</code>

Default: `--fp-model=Frz`

Description

With this option you select the floating-point execution model.

With `--fp-model=+float` you tell the compiler to treat variables and constants of type `double` as `float`. Because the `float` type takes less space, execution speed increases and code size decreases, both at the cost of less precision. Make sure you specify the corresponding libraries to the linker.

With `--fp-model=+rewrite` you allow the compiler to rewrite expressions by reassociating. This might result in rounding differences and possibly different exceptions. An example is to rewrite $(a*c)+(b*c)$ as $(a+b)*c$.

With `--fp-model=+negzero` you allow the compiler to ignore the sign of -0.0 values. An example is to replace $(a-a)$ by zero.

Related information

Pragmas `fp_negzero` and `fp_rewrite` in [Section 1.8, Pragmas to Control the Compiler](#).

C compiler option: `--fpu`

Menu entry

1. Select **C/C++ Compiler » Code Generation**.
2. Enable the option **Use FPU**.

Command line syntax

`--fpu=fpu`

You can specify the following arguments:

FPv4-sp	alias for VFPv4-sp
FPv5	alias for VFPv5
FPv5-sp	alias for VFPv5-sp
VFPv2	alias for VFPv3
VFPv3	Compile for VFPv3 architecture
VFPv3-sp	Compile for VFPv3-sp architecture
VFPv4-sp	Compile for VFPv4-sp architecture
VFPv5	Compile for VFPv5 architecture
VFPv5-sp	Compile for VFPv5-sp architecture
none	Compile for software FPU library (default)

Description

With this option you define the kind of FPU support with which you create your application. The v4 versions generate fused multiply-add operations instead of the regular compound operations. The v5 versions add VSEL, VMINNM/VMAXNM, several conversion and rounding instructions. The "sp" suffix denotes single precision floating-point only.

The macro `__FPU_fpu` is defined in the C source file. The *fpu* is converted to uppercase and the lowercase "v" and the '-' will be removed. Also when "none" is not used, the macro `__FPU_VFP__` is defined in the C source file, otherwise the macro `__FPU_NONE__` is defined.

Example

To compile the file `test.c` for the VFPv3-sp architecture, enter the following on the command line:

```
carm --fpu=VFPv3-sp test.c
```

This defines the symbols `__FPU_VFP__` and `__FPU_VFP3SP__`.

Related information

-

C compiler option: `--global-type-checking`

Menu entry

1. Select **C/C++ Compiler » Diagnostics**.
2. Enable the option **Perform global type checking on C code**.

Command line syntax

`--global-type-checking`

Description

The C compiler already performs type checking within each module. Use this option when you want the linker to perform type checking between modules.

Related information

-

C compiler option: --help (-?)

Menu entry

-

Command line syntax

`--help[=item]`

`-?`

You can specify the following arguments:

intrinsic s	i	Show the list of intrinsic functions
option s	o	Show extended option descriptions
pragma s	p	Show the list of supported pragmas
typedef s	t	Show the list of predefined typedefs

Description

Displays an overview of all command line options. With an argument you can specify which extended information is shown.

Example

The following invocations all display a list of the available command line options:

```
carml -?  
carml --help  
carml
```

The following invocation displays a list of the available pragmas:

```
carml --help=pragmas
```

Related information

-

C compiler option: `--include-directory (-I)`

Menu entry

1. Select **C/C++ Compiler » Include Paths**.

The Include paths box shows the directories that are added to the search path for include files.

2. To define a new directory for the search path, click on the **Add** button in the **Include paths** box.
3. Type or select a path.
4. Optionally enable the option **Add CMSIS include paths**.

Use the **Edit** and **Delete** button to change a path or to remove a path from the list.

Command line syntax

```
--include-directory=path,...
```

```
-Ipath,...
```

Description

With this option you can specify the path where your include files are located. A relative path will be relative to the current directory,

The order in which the compiler searches for include files is:

1. The pathname in the C source file and the directory of the C source (only for `#include` files that are enclosed in `"`)
2. The path or paths that are specified with this option. Multiple paths/options are handled by the C compiler from left to right. From Eclipse, the CMSIS include paths, if enabled, are the first option, so they are searched first.
3. The path that is specified in the environment variable `CARMINC` when the product was installed.
4. The default directory `$(PRODDIR)\include` (unless you specified option `--no-stdinc`).

Example

Suppose that the C source file `test.c` contains the following lines:

```
#include <stdio.h>
#include "myinc.h"
```

You can call the compiler as follows:

```
carm --include-directory=myinclude test.c
```

TASKING VX-toolset for ARM User Guide

First the compiler looks for the file `stdio.h` in the directory `myinclude` relative to the current directory. If it was not found, the compiler searches in the environment variable and then in the default include directory.

The compiler now looks for the file `myinc.h` in the directory where `test.c` is located. If the file is not there the compiler searches in the directory `myinclude`. If it was still not found, the compiler searches in the environment variable and then in the default include directory.

Related information

C compiler option **--include-file** (Include file at the start of a compilation)

C compiler option **--no-stdinc** (Skip standard include files directory)

C compiler option: `--include-file (-H)`

Menu entry

1. Select **C/C++ Compiler » Preprocessing**.

The Pre-include files box shows the files that are currently included before the compilation starts.

2. To define a new file, click on the **Add** button in the **Pre-include files** box.
3. Type the full path and file name or select a file.
4. (Optional) Enable the option **Include CMSIS device register definition header file**.

Use the **Edit** and **Delete** button to change a file name or to remove a file from the list.

Command line syntax

```
--include-file=file,...
```

```
-Hfile,...
```

Description

With this option you include one or more extra files at the beginning of each C source file, before other includes. This is the same as specifying `#include "file"` at the beginning of *each* of your C sources.

Example

```
carm --include-file=stdio.h test1.c test2.c
```

The file `stdio.h` is included at the beginning of both `test1.c` and `test2.c`.

Related information

C compiler option [--include-directory](#) (Add directory to include file search path)

C compiler option: `--inline`

Menu entry

1. Select **C/C++ Compiler » Optimization**.
2. Enable the option **Always inline function calls**.

Command line syntax

`--inline`

Description

With this option you instruct the compiler to inline calls to functions without the `__noinline` function qualifier whenever possible. This option has the same effect as a `#pragma inline` at the start of the source file.

This option can be useful to increase the possibilities for code compaction (C compiler option `--optimize=+compact`).

Example

To always inline function calls:

```
carm --optimize=+compact --inline test.c
```

Related information

C compiler option `--optimize=+compact` (Optimization: code compaction)

Section 1.11.2, *Inlining Functions: inline*

C compiler option: `--inline-max-incr` / `--inline-max-size`

Menu entry

1. Select **C/C++ Compiler » Optimization**.
2. In the **Maximum size increment when inlining** field, enter a value (default -1).
3. In the **Maximum size for functions to always inline** field, enter a value (default -1).

Command line syntax

```
--inline-max-incr=percentage (default: -1)
```

```
--inline-max-size=threshold (default: -1)
```

Description

With these options you can control the automatic function inlining optimization process of the compiler. These options only have effect when you have enabled the inlining optimization (option `--optimize=+inline` or **Optimize most**).

Regardless of the optimization process, the compiler always inlines all functions that have the function qualifier `inline`.

With the option `--inline-max-size` you can specify the maximum size of functions that the compiler inlines as part of the optimization process. The compiler always inlines all functions that are smaller than the specified *threshold*. The threshold is measured in compiler internal units and the compiler uses this measure to decide which functions are small enough to inline. The default threshold is -1, which means that the threshold depends on the [option `--tradeoff`](#).

After the compiler has inlined all functions that have the function qualifier `inline` and all functions that are smaller than the specified threshold, the compiler looks whether it can inline more functions without increasing the code size too much. With the option `--inline-max-incr` you can specify how much the code size is allowed to increase. The default value is -1, which means that the value depends on the [option `--tradeoff`](#).

Example

```
carm --optimize=+inline --inline-max-incr=40 --inline-max-size=15 test.c
```

The compiler first inlines all functions with the function qualifier `inline` and all functions that are smaller than the specified threshold of 15. If the code size has still not increased with 40%, the compiler decides which other functions it can inline.

Related information

C compiler option `--optimize=+inline` (Optimization: automatic function inlining)

Section 1.11.2, *Inlining Functions: inline*

C compiler option: `--interwork`

Menu entry

1. Select **C/C++ Compiler » Code Generation**.
2. Enable the option **Compile for ARM/Thumb interworking**.

Command line syntax

`--interwork`

Description

With this option the compiler generates code which supports calls between functions with the ARM and Thumb instruction set.

Use this option if your program consists of both ARM and Thumb functions.

By default this option is disabled, since it produces slightly larger code.

Related information

C compiler option `--thumb` (Use Thumb instruction set)

C compiler option: **--iso (-c)**

Menu entry

1. Select **C/C++ Compiler » Language**.
2. From the **Comply to C standard** list, select **ISO C99** or **ISO C90**.

Command line syntax

`--iso={90|99}`

`-c{90|99}`

Default: `--iso=99`

Description

With this option you select the ISO C standard. C90 is also referred to as the "ANSI C standard". C99 refers to the newer ISO/IEC 9899:1999 (E) standard. C99 is the default.

Example

To select the ISO C90 standard on the command line:

```
carm --iso=90 test.c
```

Related information

C compiler option **--language** (Language extensions)

C compiler option: `--keep-output-files (-k)`

Menu entry

Eclipse *always* removes the `.src` file when errors occur during compilation.

Command line syntax

`--keep-output-files`

`-k`

Description

If an error occurs during compilation, the resulting `.src` file may be incomplete or incorrect. With this option you keep the generated output file (`.src`) when an error occurs.

By default the compiler removes the generated output file (`.src`) when an error occurs. This is useful when you use the `make` utility. If the erroneous files are not removed, the `make` utility may process corrupt files on a subsequent invocation.

Use this option when you still want to inspect the generated assembly source. Even if it is incomplete or incorrect.

Example

```
ccarm --keep-output-files test.c
```

When an error occurs during compilation, the generated output file `test.src` will *not* be removed.

Related information

C compiler option `--warnings-as-errors` (Treat warnings as errors)

C compiler option: `--language (-A)`

Menu entry

1. Select **C/C++ Compiler » Language**.
2. Enable or disable one or more of the following options:
 - Allow GNU C extensions
 - Allow `//` comments in ISO C90 mode
 - Check assignment of string literal to non-'const' string pointer
 - Allow optimization across volatile access

Command line syntax

`--language=[flags]`

`-A[flags]`

You can set the following flags:

<code>+/-gcc</code>	<code>g/G</code>	enable a number of gcc extensions
<code>+/-kanji</code>	<code>k/K</code>	support for Shift JIS Kanji in strings
<code>+/-comments</code>	<code>p/P</code>	<code>//</code> comments in ISO C90 mode
<code>+/-volatile</code>	<code>v/V</code>	don't optimize across volatile access
<code>+/-strings</code>	<code>x/X</code>	relaxed const check for string literals

Default: `-AGKpVx`

Default (without flags): `-AGKPVX`

Description

With this option you control the language extensions the compiler can accept. By default the ARM compiler allows all language extensions, except for **gcc** extensions.

The option `--language (-A)` without flags disables all language extensions.

GNU C extensions

The `--language=+gcc (-Ag)` option enables the following gcc language extensions:

- The identifier `__FUNCTION__` expands to the current function name.
- Alternative syntax for variadic macros.
- Alternative syntax for designated initializers.

- Allow zero sized arrays.
- Allow empty struct/union.
- Allow unnamed struct/union fields.
- Allow empty initializer list.
- Allow initialization of static objects by compound literals.
- The middle operand of a `? :` operator may be omitted.
- Allow a compound statement inside braces as expression.
- Allow arithmetic on void pointers and function pointers.
- Allow a range of values after a single case label.
- Additional preprocessor directive `#warning`.
- Allow comma operator, conditional operator and cast as lvalue.
- An inline function without "static" or "extern" will be global.
- An "extern inline" function will not be compiled on its own.
- An `__attribute__` directly following a struct/union definition relates to that tag instead of to the objects in the declaration.

For a more complete description of these extensions, you can refer to the UNIX gcc info pages ([info gcc](#)).

Shift JIS Kanji support

With `--language=+kanji (-Ak)` you tell the compiler to support Shift JIS encoded Kanji multi-byte characters in strings, (wide) character constants and `//` comments. Without this option, encodings with 0x5c as the second byte conflict with the use of the backslash as an escape character. Shift JIS in `/* . . . */` comments is supported regardless of this option. Note that Shift JIS also includes Katakana and Hiragana.

Comments in ISO C90 mode

With `--language=+comments (-Ap)` you tell the compiler to allow C++ style comments (`//`) in ISO C90 mode (option `--iso=90`). In ISO C99 mode this style of comments is always accepted.

Check assignment of string literal to non-const string pointer

With `--language=+strings (-Ax)` you disable warnings about discarded `const` qualifiers when a string literal is assigned to a non-`const` pointer.

```
char *p;
int main( void )
{
    p = "hello"; // with -AX the compiler issues warning W525
```

```
    return 0;
}
```

Optimization across volatile access

With the **--language=+volatile (-Av)** option, the compiler will block optimizations when reading or writing a volatile object, by executing all memory and (SFR) register accesses before the access of the volatile object. The volatile access acts as a memory barrier. With this option you can prevent for example that code below the volatile object is optimized away to somewhere above the volatile object.

Example:

```
extern unsigned int variable;
extern volatile unsigned int access;

void TestFunc( unsigned int flag )
{
    access = 0;
    variable |= flag;
    if( variable == 3 )
    {
        variable = 0;
    }
    variable |= 0x8000;
    access = 1;
}
```

Result with **--language=-volatile** (default):

```
TestFunc:    .type    func
            str      lr,[sp,#-4]!
            ldr      r1,.L3
            ldr      lr,.L3+4
            ldr      r2,[r1,#0]      ; <== Moved across volatile access
            mov      r3,#0
            orr      r0,r2,r0
            cmp      r0,#3
            str      r3,[lr,#0]      ; <== Volatile access
            bne     .L2
            mov      r0,r3
.L2:
            orr      r0,r0,#32768
            mov      r2,#1
            str      r2,[lr,#0]      ; <== Volatile access
            str      r0,[r1,#0]      ; <== Moved across volatile access
            ldr      pc,[sp],#4
            .size   TestFunc,$-TestFunc
            .align  4
.L3:
            .dw     variable
            .dw     access
```

Result with `--language=+volatile`:

```

TestFunc:  .type    func
           str     lr,[sp,#-4]!
           ldr     r3,.L3
           ldr     r2,.L3+4
           ldr     lr,[r3,#0]
           mov     r1,#0
           orr     r0,lr,r0
           cmp     r0,#3
           str     r1,[r2,#0]      ; <== Volatile access
           str     r0,[r3,#0]      ; <== Not moved
           bne     .L2
           str     r1,[r3,#0]
.L2:
           ldr     r0,[r3,#0]
           orr     r0,r0,#32768
           str     r0,[r3,#0]      ; <== Not moved
           mov     r0,#1
           str     r0,[r2,#0]      ; <== Volatile access
           ldr     pc,[sp],#4
           .size   TestFunc,$-TestFunc
           .align  4
.L3:
           .dw     variable
           .dw     access

```

Note that the volatile behavior of the compiler with option `--language=-volatile` or `--language=+volatile` is ISO C compliant in both cases.

Related information

C compiler option `--iso` (ISO C standard)

Section 1.5, *Shift JIS Kanji Support*

C compiler option: `--make-target`

Menu entry

-

Command line syntax

`--make-target=name`

Description

With this option you can overrule the default target name in the make dependencies generated by the options `--preprocess=+make` (`-Em`) and `--dep-file`. The default target name is the basename of the input file, with extension `.obj`.

Example

```
carm --preprocess=+make --make-target=mytarget.obj test.c
```

The compiler generates dependency lines with the default target name `mytarget.obj` instead of `test.obj`.

```
mytarget.obj : test.c
test.c :
```

Related information

C compiler option `--preprocess=+make` (Generate dependencies for make)

C compiler option `--dep-file` (Generate dependencies in a file)

C compiler option: `--max-call-depth`

Menu entry

1. Select **C/C++ Compiler » Optimization**.
2. In the **Maximum call depth for code compaction** field, enter a value.

Command line syntax

`--max-call-depth=value`

Default: -1

Description

This option is related to the compiler optimization `--optimize=+compact` (Code compaction or reverse inlining). Code compaction is the opposite of inlining functions: large sequences of code that occur more than once, are transformed into a function. This reduces code size (possibly at the cost of execution speed).

During code compaction it is possible that the compiler generates nested calls. This may cause the program to run out of its stack. To prevent stack overflow caused by too deeply nested function calls, you can use this option to limit the call depth. This option can have the following values:

- 1 Poses no limit to the call depth (default)
- 0 The compiler will not generate any function calls. (Effectively the same as if you turned off code compaction with option `--optimize=-compact`)
- > 0 Code sequences are only reversed if this will not lead to code at a call depth larger than specified with *value*. Function calls will be placed at a call depth no larger than *value*-1. (Note that if you specified a value of 1, the option `--optimize=+compact` may remain without effect when code sequences for reversing contain function calls.)

This option does not influence the call depth of user written functions.

If you use this option with various C modules, the call depth is valid for each individual module. The call depth after linking may differ, depending on the nature of the modules.

Related information

C compiler option `--optimize=+compact` (Optimization: code compaction)

C compiler option `--compact-max-size` (Maximum size of a match for code compaction)

C compiler option: `--mil / --mil-split`

Menu entry

1. Select **C/C++ Compiler » Optimization**.
2. Enable the option **Build for application wide optimizations (MIL linking)**.
3. Select **Optimize less/Build faster** or **Optimize more/Build slower**.

Command line syntax

```
--mil  
--mil-split[=file,...]
```

Description

With option `--mil` the C compiler skips the code generator phase and writes the optimized intermediate representation (MIL) to a file with the suffix `.mil`. The C compiler accepts `.mil` files as input files on the command line.

Option `--mil-split` does the same as option `--mil`, but in addition, the C compiler splits the MIL representation and writes it to separate files with suffix `.ms`. One file is written for each input file or MIL library specified on the command line. The `.ms` files are only updated on a change. The C compiler accepts `.ms` files as input files on the command line.

With option `--mil-split` you can perform application-wide optimizations during the frontend phase by specifying all modules at once, and still invoke the backend phase one module at a time to reduce the total compilation time. Application wide code compaction is not possible in this case.

Optionally, you can specify another filename for the `.ms` file the C compiler generates. Without an argument, the basename of the C source file is used to create the `.ms` filename. Note that if you specify a filename, you have to specify one filename for every input file.

Note that with both options some extra strict type checking is done that can cause building to fail in a way that is unforeseen and difficult to understand. For example, when you use one of these options in combination with option `--uchar` and you link the MIL library, you might get the following error:

```
carm E289: [".\..\..\..\strlen.c" 14/1] "strlen" redeclared with a different type  
carm I802: ["installation-dir\include\string.h" 44/17]  
          previous declaration of "strlen"  
1 errors, 0 warnings
```

This is caused by the fact that the MIL library is built without `--uchar`. You can workaround this problem by rebuilding the MIL libraries.

Build for application wide optimizations (MIL linking) and Optimize less/Build faster

This option is standard MIL linking and splitting. Note that you can control the optimizations to be performed with the optimization settings.

Optimize more/Build slower

When you enable this option, the compiler's frontend does not split the MIL stream in separate modules, but feeds it directly to the compiler's backend, allowing the code compaction to be performed application wide.

Related information

Section 4.1, *Compilation Process*

Control program option `--mil-link / --mil-split`

C compiler option: `--misrac`

Menu entry

1. Select **C/C++ Compiler » MISRA C**.
2. Make a selection from the **MISRA C checking** list.
3. If you selected **Custom**, expand the **Custom 1998**, **Custom 2004** or **Custom 2012** entry and enable one or more individual rules.

Command line syntax

```
--misrac={all | nr[-nr]},...
```

Description

With this option you specify to the compiler which MISRA C rules must be checked. With the option `--misrac=all` the compiler checks for all supported MISRA C rules.

Example

```
carm --misrac=9-13 test.c
```

The compiler generates an error for each MISRA C rule 9, 10, 11, 12 or 13 violation in file `test.c`.

Related information

Section 4.6.2, *C Code Checking: MISRA C*

C compiler option `--misrac-mandatory-warnings`

C compiler option `--misrac-advisory-warnings`

C compiler option `--misrac-required-warnings`

Linker option `--misrac-report`

C compiler option: `--misrac-advisory-warnings` / `--misrac-required-warnings` / `--misrac-mandatory-warnings`

Menu entry

1. Select **C/C++ Compiler » MISRA C**.
2. Make a selection from the **MISRA C checking** list.
3. Enable one or more of the options:
 - Warnings instead of errors for mandatory rules**
 - Warnings instead of errors for required rules**
 - Warnings instead of errors for advisory rules.**

Command line syntax

```
--misrac-advisory-warnings  
--misrac-required-warnings  
--misrac-mandatory-warnings
```

Description

Normally, if an advisory rule, required rule or mandatory rule is violated, the compiler generates an error. As a consequence, no output file is generated. With this option, the compiler generates a warning instead of an error.

Related information

Section 4.6.2, *C Code Checking: MISRA C*

C compiler option `--misrac`

Linker option `--misrac-report`

C compiler option: `--misrac-version`

Menu entry

1. Select **C/C++ Compiler » MISRA C**.
2. Select the **MISRA C version: 1998, 2004 or 2012**.

Command line syntax

```
--misrac-version={1998 | 2004 | 2012}
```

Default: 2004

Description

MISRA C rules exist in three versions: MISRA C:1998, MISRA C:2004 and MISRA C:2012. By default, the C source is checked against the MISRA C:2004 rules. With this option you can select which version to use.

Related information

Section 4.6.2, *C Code Checking: MISRA C*

C compiler option `--misrac`

C compiler option: `--no-double` (-F)

Menu entry

1. Select **C/C++ Compiler » Language**.
2. Enable the option **Treat 'double' as 'float'**.

Command line syntax

`--no-double`

`-F`

Description

With this option you tell the compiler to treat variables and constants of type `double` as `float`. Because the `float` type takes less space, execution speed increases and code size decreases, both at the cost of less precision.

This option is an alias for C compiler option `--fp-model=+float`.

Example

```
carc --no-double test.c
```

The file `test.c` is compiled where variables and constants of type `double` are treated as `float`.

Related information

C compiler option `--fp-model` (floating-point model)

C compiler option: `--no-stdinc`

Menu entry

1. Select **C/C++ Compiler » Miscellaneous**.
2. Add the option `--no-stdinc` to the **Additional options** field.

Command line syntax

`--no-stdinc`

Description

With this option you tell the compiler not to look in the default `include` directory relative to the installation directory, when searching for include files. This way the compiler only searches in the include file search paths you specified.

Related information

C compiler option `--include-directory` (Add directory to include file search path)

Section 4.3, *How the Compiler Searches Include Files*

C compiler option: `--no-warnings (-w)`

Menu entry

1. Select **C/C++ Compiler » Diagnostics**.

The Suppress C compiler warnings box shows the warnings that are currently suppressed.

2. To suppress a warning, click on the **Add** button in the **Suppress warnings** box.
3. Enter the numbers, separated by commas or as a range, of the warnings you want to suppress (for example 537, 538). Or you can use the **Add** button multiple times.
4. To suppress all warnings, enable the option **Suppress all warnings**.

Use the **Edit** and **Delete** button to change a warning number or to remove a number from the list.

Command line syntax

```
--no-warnings [=number[-number], ...]
```

```
-w [number[-number], ...]
```

Description

With this option you can suppresses all warning messages or specific warning messages.

On the command line this option works as follows:

- If you do not specify this option, all warnings are reported.
- If you specify this option but without numbers, all warnings are suppressed.
- If you specify this option with a number or a range, only the specified warnings are suppressed. You can specify the option `--no-warnings=number` multiple times.

Example

To suppress warnings 537 and 538, enter:

```
carm test.c --no-warnings=537,538
```

Related information

[C compiler option `--warnings-as-errors`](#) (Treat warnings as errors)

[Pragma warning](#)

C compiler option: **--optimize (-O)**

Menu entry

1. Select **C/C++ Compiler » Optimization**.
2. Select an optimization level in the **Optimization level** box.

Command line syntax

`--optimize[=flags]`

`-Oflags`

You can set the following flags:

+/-coalesce	a/A	Coalescer: remove unnecessary moves
+/-ipro	b/B	Interprocedural register optimizations
+/-cse	c/C	Common subexpression elimination
+/-expression	e/E	Expression simplification
+/-flow	f/F	Control flow simplification
+/-glo	g/G	Generic assembly code optimizations
+/-inline	i/I	Automatic function inlining
+/-sign	j/J	Sign extend elimination
+/-schedule	k/K	Instruction scheduler
+/-loop	l/L	Loop transformations
+/-forward	o/O	Forward store
+/-propagate	p/P	Constant propagation
+/-compact	r/R	Code compaction (reverse inlining)
+/-subscript	s/S	Subscript strength reduction
+/-unroll	u/U	Unroll small loops
+/-peephole	y/Y	Peephole optimizations
+/-cluster		Cluster global variables

Use the following options for predefined sets of flags:

--optimize=0	-O0	No optimization Alias for -OaBCEFGIJKLOPRSUY,-cluster
---------------------	------------	---

No optimizations are performed except for the coalescer (to allow better debug information). The compiler tries to achieve an optimal resemblance between source code and produced code. Expressions are evaluated in the same order as written in the source code, associative and commutative properties are not used.

--optimize=1 **-O1** Optimize
Alias for **-OabcefgJKLOPRSUy,-cluster**

Enables optimizations that do not affect the debug ability of the source code. Use this level when you encounter problems during debugging your source code with optimization level 2.

--optimize=2 **-O2** Optimize more (default)
Alias for **-OabcefgJklopsrUy,-cluster**

Enables more optimizations to reduce code size and/or execution time. This is the default optimization level.

--optimize=3 **-O3** Optimize most
Alias for **-OabcefgJklopsrUy,+cluster**

This is the highest optimization level. Use this level to decrease execution time to meet your real-time requirements.

Default: **--optimize=2**

Description

With this option you can control the level of optimization. If you do not use this option, the default optimization level is *Optimize more* (option **--optimize=2** or **--optimize**).

When you use this option to specify a set of optimizations, you can overrule these settings in your C source file with `#pragma optimize flag/#pragma endoptimize`.

In addition to the option **--optimize**, you can specify the option **--tradeoff (-t)**. With this option you specify whether the used optimizations should optimize for more speed (regardless of code size) or for smaller code size (regardless of speed).

Example

The following invocations are equivalent and result all in the default optimization set:

```
carm test.c
```

```
carm --optimize=2 test.c
carm -O2 test.c
```

```
carm --optimize test.c
carm -O test.c
```

```
carm -OabcefgJklopsrUy test.c
carm --optimize=+coalesce,+ipro,+cse,+expression,+flow,+glo,
      -inline,-sign,+schedule,+loop,+forward,+propagate,
      +compact,+subscript,-unroll,+peephole,-cluster test.c
```

Related information

C compiler option **--tradeoff** (Trade off between speed and size)

Pragma `optimize/endoptimize`

Section 4.5, *Compiler Optimizations*

C compiler option: `--option-file (-f)`

Menu entry

1. Select **C/C++ Compiler » Miscellaneous**.
2. Add the option `--option-file` to the **Additional options** field.

Be aware that the options in the option file are added to the C compiler options you have set in the other pages. Only in extraordinary cases you may want to use them in combination.

Command line syntax

```
--option-file=file,...
```

```
-f file,...
```

Description

This option is primarily intended for command line use. Instead of typing all options on the command line, you can create an option file which contains all options and flags you want to specify. With this option you specify the option file to the compiler.

Use an option file when the command line would exceed the limits of the operating system, or just to store options and save typing.

You can specify the option `--option-file` multiple times.

Format of an option file

- Multiple arguments on one line in the option file are allowed.
- To include whitespace in an argument, surround the argument with single or double quotes.
- If you want to use single quotes as part of the argument, surround the argument by double quotes and vice versa:

```
"This has a single quote ' embedded"
```

```
'This has a double quote " embedded'
```

```
'This has a double quote " and a single quote ''' embedded"
```

- When a text line reaches its length limit, use a `\` to continue the line. Whitespace between quotes is preserved.

```
"This is a continuation \  
line"
```

```
-> "This is a continuation line"
```

TASKING VX-toolset for ARM User Guide

- It is possible to nest command line files up to 25 levels.

Example

Suppose the file `myoptions` contains the following lines:

```
--debug-info  
--define=DEMO=1  
test.c
```

Specify the option file to the compiler:

```
carm --option-file=myoptions
```

This is equivalent to the following command line:

```
carm --debug-info --define=DEMO=1 test.c
```

Related information

-

C compiler option: --output (-o)

Menu entry

Eclipse names the output file always after the C source file.

Command line syntax

```
--output=file
```

```
-o file
```

Description

With this option you can specify another filename for the output file of the compiler. Without this option the basename of the C source file is used with extension `.src`.

Example

To create the file `output.src` instead of `test.src`, enter:

```
carm --output=output.src test.c
```

Related information

-

C compiler option: --preprocess (-E)

Menu entry

1. Select **C/C++ Compiler » Preprocessing**.
2. Enable the option **Store preprocessor output in <file>.pre**.
3. (Optional) Enable the option **Keep comments in preprocessor output**.
4. (Optional) Enable the option **Keep #line info in preprocessor output**.

Command line syntax

`--preprocess [=flags]`

`-E[flags]`

You can set the following flags:

+/-comments	c/C	keep comments
+/-includes	i/I	generate a list of included source files
+/-list	I/L	generate a list of macro definitions
+/-make	m/M	generate dependencies for make
+/-noline	p/P	strip #line source position information

Default: `-ECILMP`

Description

With this option you tell the compiler to preprocess the C source. Under Eclipse the compiler sends the preprocessed output to the file `name.pre` (where `name` is the name of the C source file to compile). Eclipse also compiles the C source.

On the command line, the compiler sends the preprocessed file to stdout. To capture the information in a file, specify an output file with the option `--output`.

With `--preprocess=+comments` you tell the preprocessor to keep the comments from the C source file in the preprocessed output.

With `--preprocess=+includes` the compiler will generate a list of all included source files. The preprocessor output is discarded.

With `--preprocess=+list` the compiler will generate a list of all macro definitions. The preprocessor output is discarded.

With `--preprocess=+make` the compiler will generate dependency lines that can be used in a Makefile. The preprocessor output is discarded. The default target name is the basename of the input file, with the extension `.obj`. With the option `--make-target` you can specify a target name which overrules the default target name.

With **--preprocess=+noline** you tell the preprocessor to strip the #line source position information (lines starting with #line). These lines are normally processed by the assembler and not needed in the preprocessed output. When you leave these lines out, the output is easier to read.

Example

```
carm --preprocess=+comments,+includes,-list,-make,-noline test.c --output=test.pre
```

The compiler preprocesses the file `test.c` and sends the output to the file `test.pre`. Comments and a list of all included source files are included but no list of macro definitions and no dependencies are generated and the line source position information is not stripped from the output file.

Related information

C compiler option **--dep-file** (Generate dependencies in a file)

C compiler option **--make-target** (Specify target name for **-Em** output)

C compiler option: --profile (-p)

Menu entry

1. Select **C/C++ Compiler » Debugging**.
2. Enable or disable **Static profiling**.
3. Enable or disable one or more of the following **Generate profiling information** options (dynamic profiling):
 - **for block counters** (not in combination with Call graph or Function timers)
 - **to build a call graph**
 - **for function counters**
 - **for function timers**
4. Optionally, when you selected function timers, enable option **Exclude time spent in interrupt functions**.

Note that the more detailed information you request, the larger the overhead in terms of execution time, code size and heap space needed. The option **--debug** does not affect profiling, execution time or code size.

Command line syntax

`--profile[=flag, ...]`

`-p[flags]`

Use the following option for a predefined set of flags:

--profile=g	-pg	Profiling with call graph and function timers. Alias for: -pBcFStI
--------------------	------------	--

You can set the following flags:

+/-block	b/B	block counters
+/-callgraph	c/C	call graph
+/-function	f/F	function counters
+/-interrupt	i/I	exclude interrupt time
+/-static	s/S	static profile generation
+/-time	t/T	function timers

Default: **-pBcFStI**

Default (without flags): `-pBCfSTI`

Description

Profiling is the process of collecting statistical data about a running application. With these data you can analyze which functions are called, how often they are called and what their execution time is.

Several methods of profiling exist. One method is *code instrumentation* which adds code to your application that takes care of the profiling process when the application is executed. Another method is *static profiling*.

For an extensive description of profiling refer to [Chapter 13, Profiling](#).

You can obtain the following profiling data (see flags above):

Block counters (not in combination with Call graph or Function timers)

This will instrument the code to perform basic block counting. As the program runs, it counts the number of executions of each branch in an if statement, each iteration of a for loop, and so on. Note that though you can combine Block counters with Function counters, this has no effect because Function counters is only a subset of Block counters.

Call graph (not in combination with Block counters)

This will instrument the code to reconstruct the run-time call graph. As the program runs it associates the caller with the gathered profiling data.

Function counters

This will instrument the code to perform function call counting. This is a subset of the basic Block counters.

Function timers (not in combination with Block counters/Function counters)

This will instrument the code to measure the time spent in a function. This includes the time spent in all sub functions (callees). Also the time spent in interrupt functions is taken into account, unless you enable option **Exclude time spent in interrupt functions (-pti)**.

Static profiling

With this option you do not need to run the application to get profiling results. The compiler generates profiling information at compile time, without adding extra code to your application.

If you use one or more profiling options that use code instrumentation, you must link the corresponding libraries too! Refer to [Section 7.3, Linking with Libraries](#), for an overview of the (profiling) libraries. In Eclipse the correct libraries are linked automatically.

Example

To generate block count information for the module `test.c` during execution, compile as follows:

```
carm --profile=+block test.c
```

In this case you must link the library `libpb.a`.

Related information

Chapter 13, *Profiling*

C compiler option: `--rename-sections (-R)`

Menu entry

1. Select **C/C++ Compiler » Miscellaneous**.
2. Add the option `--rename-sections` to the **Additional options** field.

Command line syntax

```
--rename-sections=[name=]suffix
```

```
-R[name=]suffix
```

Description

In case a module must be loaded at a fixed address, or a data section needs a special place in memory, you can use this option to generate different section names. You can then use this unique section name in the linker script file for locating. Because sections have reserved names, the compiler will not actually change the section name, but will add a suffix to the name.

With the section *name* you select which sections are renamed. With *suffix* you specify the suffix part which will be attached to the existing name. The suffix can contain the following suffix specifiers:

<code>{module}</code>	expands to the module name
<code>{name}</code>	expands to the symbol name as generated in the assembly file, including compiler generated prefixes and suffixes
<code>{cname}</code>	expands to the symbol name as used in your C source. Compiler generated names will be cleaned up and prefixed by a '\$'.

If you do not specify a section name, all sections will receive the specified suffix.

Example

To change all sections named `.data` into `.data.NEW`, enter:

```
carm --rename-sections=.data=NEW test.c
```

To add the name of the current module as suffix to all data sections, resulting in `.data.test`, enter:

```
carm --rename-sections=.data={module} test.c
```

The following examples show the difference when using `--rename-sections={name}` or `--rename-sections={cname}`.

Generated labels:

```
.section .text.tm..cocofun_1 ;; {name}
.section .text.tm.$cocofun   ;; {cname}
.section .rodata.hs..l.str   ;; {name}
.section .rodata.hs.$str     ;; {cname}
```

TASKING VX-toolset for ARM User Guide

```
.section .rodata.hs..2.ini    ;; {name}
.section .rodata.hs.$ini     ;; {cname}
```

Statics within a function:

```
.section .data.hs._999001_my_local  ;; {name}
.section .data.hs.my_local          ;; {cname}
.section .data.hs._999002_my_local  ;; {name}
.section .data.hs.my_local          ;; {cname}
```

Several modules with static functions of the same name:

```
.section .text.hs1.f1    ;; {name}
.section .text.hs1.f1    ;; {cname}
.section .text.hs2.f1.1  ;; {name}
.section .text.hs2.f1    ;; {cname}
```

Related information

[Assembler directive `.SECTION`](#)

C compiler option: `--runtime (-r)`

Menu entry

1. Select **C/C++ Compiler » Debugging**.
2. Enable or disable one or more of the following run-time error checking options:
 - Generate code for bounds checking
 - Generate code to detect unhandled case in a switch
 - Generate code for malloc consistency checks
 - Generate code for stack overflow checks (allowed for USR and SYS mode only)
 - Generate code for division by zero checks

Command line syntax

```
--runtime[=flag,...]
```

```
-r[flags]
```

You can set the following flags:

+/-bounds	b/B	bounds checking
+/-case	c/C	report unhandled case in a switch
+/-malloc	m/M	malloc consistency checks
+/-stack	s/S	check for stack overflow
+/-zero	z/Z	check for divide by zero

Default (without flags): `-rbcmsz`

Description

This option controls a number of run-time checks to detect errors during program execution. Some of these checks require additional code to be inserted in the generated code, and may therefore slow down the program execution. The following checks are available:

Bounds checking

Every pointer update and dereference will be checked to detect out-of-bounds accesses, null pointers and uninitialized automatic pointer variables. This check will increase the code size and slow down the program considerably. In addition, some heap memory is allocated to store the bounds information. You may enable bounds checking for individual modules or even parts of modules only (see `#pragma runtime`).

Report unhandled case in a switch

Report an unhandled case value in a switch without a default part. This check will add one function call to every switch without a default part, but it will have little impact on the execution speed.

Malloc consistency checks

This option enables the use of wrappers around the functions malloc/realloc/free that will check for common dynamic memory allocation errors like:

- buffer overflow
- write to freed memory
- multiple calls to free
- passing invalid pointer to free

Enabling this check will extract some additional code from the library, but it will not enlarge your application code. The dynamic memory usage will increase by a couple of bytes per allocation.

Stack overflow check

The compiler generates extra code within the function prolog that will check the available stack size before allocating. This is only useful when the processor runs in USR or SYS mode.

Division by zero check

The compiler generates a call to specific run-time functions for additional division by zero checks. If this situation occurs, an abort signal is issued. Without this check, a division by zero could lead to unpredictable results.

Related information

[Pragma runtime](#)

C compiler option: `--silicon-bug`

Menu entry

1. Expand **C/C++ Build** and select **Processor**.
2. From the **Processor selection** list, select a processor.

*The **CPU problem bypasses and checks** box shows the available workarounds/checks available for the selected processor.*

3. (Optional) Select **Show all CPU problem bypasses and checks**.
4. Click **Select All** or select one or more individual options.

Command line syntax

```
--silicon-bug[=bug, ...]
```

Description

With this option you specify for which hardware problems the compiler should generate workarounds. Please refer to [Chapter 19, CPU Problem Bypasses and Checks](#) for the numbers and descriptions. Silicon bug numbers are specified as a comma separated list. When you use this option without arguments, all silicon bug workarounds are enabled.

Example

To enable workarounds for problem 602117, enter:

```
carm --silicon-bug=602117 test.c
```

Related information

[Chapter 19, CPU Problem Bypasses and Checks](#)

Assembler option `--silicon-bug`

C compiler option: --source (-s)

Menu entry

1. Select **C/C++ Compiler » Miscellaneous**.
2. Enable the option **Merge C source code with generated assembly**.

Command line syntax

--source

-s

Description

With this option you tell the compiler to merge C source code with generated assembly code in the output file. The C source lines are included as comments.

Related information

Pragmas [source/nosource](#)

C compiler option: `--stdout (-n)`

Menu entry

-

Command line syntax

`--stdout`

`-n`

Description

With this option you tell the compiler to send the output to `stdout` (usually your screen). No files are created. This option is for example useful to quickly inspect the output or to redirect the output to other tools.

Related information

-

C compiler option: `--thumb`

Menu entry

1. Select **C/C++ Compiler » Code Generation**.
2. Enable the option **Use Thumb instruction set**.

Command line syntax

`--thumb`

Description

With this option you tell the compiler to generate Thumb or Thumb-2 instructions, depending on the architecture.

When you specify the ARMv6-M, ARMv7-M or ARMv7E-M architecture (option `--cpu`), the compiler automatically selects the Thumb-2 instruction set.

Related information

C compiler option `--cpu` (Select architecture)

C compiler option `--interwork` (Generate interworking code)

C compiler option: `--tradeoff (-t)`

Menu entry

1. Select **C/C++ Compiler » Optimization**.
2. Select a trade-off level in the **Trade-off between speed and size** box.

Command line syntax

```
--tradeoff={0|1|2|3|4}
```

```
-t{0|1|2|3|4}
```

Default: `--tradeoff=4`

Description

If the compiler uses certain optimizations (option `--optimize`), you can use this option to specify whether the used optimizations should optimize for more speed (regardless of code size) or for smaller code size (regardless of speed).

By default the compiler optimizes for code size (`--tradeoff=4`).

If you have not specified the option `--optimize`, the compiler uses the default *Optimize more* optimization. In this case it is still useful to specify a trade-off level.

Example

To set the trade-off level for the used optimizations:

```
carm --tradeoff=2 --thumb test.c
```

The compiler uses the default *Optimize more* optimization level and optimizes for code size.

Related information

[C compiler option `--optimize`](#) (Specify optimization level)

[Section 4.5.3, *Optimize for Code Size or Execution Speed*](#)

C compiler option: `--uchar (-u)`

Menu entry

1. Select **C/C++ Compiler » Language**.
2. Enable the option **Treat 'char' variables as unsigned**.

Command line syntax

`--uchar`

`-u`

Description

By default `char` is the same as specifying `signed char`. With this option `char` is the same as `unsigned char`.

Note that this option can cause conflicts when you use it in combination with MIL linking. With MIL linking some extra strict type checking is done that can cause building to fail in a way that is unforeseen and difficult to understand. For example, when you use option `--mil` in combination with option `--uchar` and you link the MIL library, you might get the following error:

```
carm E289: [ "..\..\..\strlen.c" 14/1] "strlen" redeclared with a different type
carm I802: ["installation-dir\include\string.h" 44/17]
           previous declaration of "strlen"
1 errors, 0 warnings
```

This is caused by the fact that the MIL library is built without `--uchar`. You can workaround this problem by rebuilding the MIL libraries.

Related information

Section 1.1, *Data Types*

C compiler option: `--unaligned-access`

Menu entry

1. Select **C/C++ Compiler » Miscellaneous**.
2. Add the option `--unaligned-access` to the **Additional options** field.

Command line syntax

`--unaligned-access`

Description

With this option you tell the compiler to generate more efficient instructions to access unaligned 16-bit or larger data. Halfword or word load and store instructions are used instead of byte instructions.

This option is only useful for cores that have support for unaligned access.

Related information

-

C compiler option: --undefine (-U)

Menu entry

1. Select **C/C++ Compiler » Preprocessing**

The Defined symbols box shows the symbols that are currently defined.

2. To remove a defined symbol, select the symbol in the **Defined symbols** box and click on the **Delete** button.

Command line syntax

`--undefine=macro_name`

`-Umacro_name`

Description

With this option you can undefine an earlier defined macro as with `#undef`. This option is for example useful to undefine predefined macros.

The following predefined ISO C standard macros cannot be undefined:

<code>__FILE__</code>	current source filename
<code>__LINE__</code>	current source line number (int type)
<code>__TIME__</code>	hh:mm:ss
<code>__DATE__</code>	Mmm dd yyyy
<code>__STDC__</code>	level of ANSI standard

Example

To undefine the predefined macro `__TASKING__`:

```
carm --undefine=__TASKING__ test.c
```

Related information

C compiler option `--define` (Define preprocessor macro)

Section 1.9, *Predefined Preprocessor Macros*

C compiler option: --verbose (-v)

Menu entry

-

Command line syntax

--verbose

-v

Description

With this option you put the C compiler in verbose mode. The C compiler performs its tasks while it prints the steps it performs to `stdout`.

Related information

-

C compiler option: --version (-V)

Menu entry

-

Command line syntax

`--version`

`-V`

Description

Display version information. The compiler ignores all other options or input files.

Related information

-

C compiler option: `--warnings-as-errors`

Menu entry

1. Select **Global Options**.
2. Enable the option **Treat warnings as errors**.

Command line syntax

```
--warnings-as-errors [=number [-number] , ...]
```

Description

If the compiler encounters an error, it stops compiling. When you use this option without arguments, you tell the compiler to treat all warnings not suppressed by option `--no-warnings` (or `#pragma warning`) as errors. This means that the exit status of the compiler will be non-zero after one or more compiler warnings. As a consequence, the compiler now also stops after encountering a warning.

You can limit this option to specific warnings by specifying a comma-separated list of warning numbers or ranges. In this case, this option takes precedence over option `--no-warnings` (and `#pragma warning`).

Related information

[C compiler option `--no-warnings`](#) (Suppress some or all warnings)

[Pragma warning](#)

11.3. C++ Compiler Options

This section lists all C++ compiler options.

Options in Eclipse versus options on the command line

Most command line options have an equivalent option in Eclipse but some options are only available on the command line. Eclipse invokes the C++ compiler via the control program. Therefore, it uses the syntax of the control program to pass options and files to the C++ compiler. If there is no equivalent option in Eclipse, you can specify a command line option in Eclipse as follows:

1. From the **Project** menu, select **Properties for**

The Properties dialog appears.

2. In the left pane, expand **C/C++ Build** and select **Settings**.

In the right pane the Settings appear.

3. On the Tool Settings tab, select **C/C++ Compiler » Miscellaneous**.

4. In the **Additional options** field, enter one or more command line options.

*Because Eclipse uses the control program, you have to precede the option with **-Wcp** to pass the option via the control program directly to the C++ compiler.*

Short and long option names

Options can have both short and long names. Short option names always begin with a single minus (-) character, long option names always begin with two minus (--) characters. You can abbreviate long option names as long as it forms a unique name. You can mix short and long option names on the command line.

If an option requires an argument, the argument may be separated from the keyword by white space, or the keyword may be immediately followed by `=option`. When the second form is used there may not be any white space on either side of the equal sign.

Options can have flags or suboptions. To switch a flag 'on', use a lowercase letter or a `+longflag`. To switch a flag off, use an uppercase letter or a `-longflag`. Separate `longflags` with commas. The following two invocations are equivalent:

```
cparm -Ecp test.cc
cparm --preprocess=+comments,+noline test.cc
```

When you do not specify an option, a default value may become active.

The priority of the options is left-to-right: when two options conflict, the first (most left) one takes effect. The **-D** and **-U** options are not considered conflicting options, so they are processed left-to-right for each source file. You can overrule the default output file name with the **--output-file** option.

C++ compiler option: `--alternative-tokens`

Menu entry

-

Command line syntax

`--alternative-tokens`

Description

Enable recognition of alternative tokens. This controls recognition of the digraph tokens in C++, and controls recognition of the operator keywords (e.g., `not`, `and`, `bitand`, etc.).

Example

To enable operator keywords (e.g., `"not"`, `"and"`) and digraphs, enter:

```
cparm --alternative-tokens test.cc
```

Related information

-

C++ compiler option: --anachronisms

Menu entry

1. Select **C/C++ Compiler » Language**.
2. Enable the option **C++ anachronisms**.

Command line syntax

--anachronisms

Description

Enable C++ anachronisms. This option also enables **--nonconst-ref-anachronism**. But you can turn this off individually with option **--no-nonconst-ref-anachronism**.

Related information

C++ compiler option **--nonconst-ref-anachronism** (Nonconst reference anachronism)

Section 2.2.3, *Anachronisms Accepted*

C++ compiler option: `--auto-type`

Menu entry

-

Command line syntax

`--auto-type`

`--no-auto-type`

Default: `auto` is a storage class specifier.

Description

Enable or disable `auto` as a type specifier where the actual type is deduced from an initializer that follows.

This feature is implicitly enabled in C++11 mode.

Related information

C++ compiler option `--no-auto-storage` (Do not allow `auto` as storage specifier)

C++ compiler option `--c++11` (C++11 language extensions)

C++ compiler option: --base-assign-op-is-default

Menu entry

-

Command line syntax

`--base-assign-op-is-default`

Description

Enable the anachronism of accepting a copy assignment operator that has an input parameter that is a reference to a base class as a default copy assignment operator for the derived class.

Related information

-

C++ compiler option: --building-runtime

Menu entry

-

Command line syntax

`--building-runtime`

Description

Special option for building the C++ run-time library. Used to indicate that the C++ run-time library is being compiled. This causes additional macros to be predefined that are used to pass configuration information from the C++ compiler to the run-time.

Related information

-

C++ compiler option: --c++03

Menu entry

1. Select **C/C++ Compiler » Language**.
2. From the **Comply to C++ standard** list, select **ISO C++03**.

Command line syntax

`--c++03`

Description

Enable the C++ extensions that are defined by the ISO/IEC 14882:2003 standard. C++11 extensions are disabled, unless you enable individual options.

Related information

-

C++ compiler option: `--c++11`

Menu entry

1. Select **C/C++ Compiler » Language**.
2. From the **Comply to C++ standard** list, select **ISO C++11**.

Command line syntax

`--c++11`

Description

Enable the C++ extensions that are defined by the C++11 standard (ISO/IEC 14882:2011). This option also enables exceptions.

Related information

C++ compiler option `--exceptions` (Enable exceptions)

C++ compiler option: `--c++11-sfinae`

Menu entry

-

Command line syntax

`--c++11-sfinae`

`--no-c++11-sfinae`

Description

Enable or disable template deduction in the style dictated by the C++11 standard (SFINAE rules of document N2634), i.e., where general expressions are allowed in deduction contexts and they undergo the full usual semantic checking. This type of deduction is necessary to get the full power of the `decltype` feature in return types. “SFINAE” refers to the initials of the phrase “Substitution Failure Is Not An Error”, which is the guiding principle for template deduction, and by extension a name for the process of deduction.

This feature is implicitly enabled in C++11 mode (option `--c++11`), and is implicitly disabled in GNU modes.

Related information

C++ compiler option `--c++11` (C++11 language extensions)

C++ compiler option: `--c++11-sfinae-ignore-access`

Menu entry

-

Command line syntax

`--c++11-sfinae-ignore-access`

`--no-c++11-sfinae-ignore-access`

Default: `--no-c++11-sfinae-ignore-access`

Description

When C++11 SFINAE is enabled (option `--c++11-sfinae`), option `--c++11-sfinae-ignore-access` indicates that access errors are not counted as errors that cause deduction failures. In document N2634 access errors are ignored, but the standards committee changed its mind about that later. So, the default (option `--no-c++11-sfinae-ignore-access`) is that access errors cause a deduction failure.

Related information

C++ compiler option `--c++11-sfinae` (C++11 SFINAE rules)

C++ compiler option: `--c++14`

Menu entry

1. Select **C/C++ Compiler » Language**.
2. From the **Comply to C++ standard** list, select **ISO C++14**.

Command line syntax

`--c++14`

Description

Enable the C++ extensions that are defined by the C++14 standard (ISO/IEC 14882:2014). This option also enables exceptions.

Related information

C++ compiler option `--exceptions` (Enable exceptions)

C++ compiler option: `--check`

Menu entry

-

Command line syntax

`--check`

Description

With this option you can check the source code for syntax errors, without generating code. This saves time in developing your application because the code will not actually be compiled.

The C++ compiler reports any warnings and/or errors.

This option is available on the command line only.

Related information

C compiler option `--check` (Check syntax)

Assembler option `--check` (Check syntax)

C++ compiler option: --check-concatenations

Menu entry

-

Command line syntax

`--check-concatenations`

Description

With this option the preprocessor will generate a diagnostic when a macro concatenation (such as a ## b) does not result in a valid token.

Related information

-

C++ compiler option: `--compound-literals`

Menu entry

-

Command line syntax

`--compound-literals`

Description

Allow compound literals in expressions. A compound literal looks like a cast containing an initializer. Its value is an object of the type specified in the cast, containing the elements specified in the initializer; it is an lvalue.

For example:

```
static int i[] = (int []) {1, 2, 3};
```

Related information

-

C++ compiler option: `--context-limit`

Menu entry

-

Command line syntax

`--context-limit=number`

Default: `--context-limit=10`

Description

Set the context limit to *number*. The context limit is the maximum number of template instantiation context entries to be displayed as part of a diagnostic message. If the number of context entries exceeds the limit, the first and last *N* context entries are displayed, where *N* is half of the context limit. A value of zero is used to indicate that there is no limit.

Example

To set the context limit to 5, enter:

```
cparm --context-limit=5 test.cc
```

Related information

-

C++ compiler option: `--cpu (-C)`

Menu entry

1. Expand **C/C++ Build** and select **Processor**.
2. From the **Processor selection** list, make a selection by **Architecture**, **Core** or one of the manufacturers.

Command line syntax

`--cpu=architecture`

`-Carchitecture`

You can specify the following architectures:

ARMv6M	Compile for ARMv6-M architecture
ARMv7M	Compile for ARMv7-M architecture
ARMv7EM	Compile for ARMv7E-M architecture
ARMv7R	Compile for ARMv7-R architecture

Description

With this option you specify the ARM architecture for which you create your application. The ARM target supports more than one architecture and therefore you need to specify for which architecture the compiler should compile. The architecture determines which instructions are valid and which are not.

The effect of this option is that the C++ compiler uses the appropriate instruction set. You choose one of the following architectures: ARMv6-M, ARMv7-M, ARMv7E-M or ARMv7-R.

The macro `__CPU__` is set to the name of the *architecture*.

Example

To compile the file `test.cc` for the ARMv7E-M architecture, enter the following on the command line:

```
cparm --cpu=ARMv7EM test.cc
```

Related information

C compiler option `--cpu` (Select architecture)

C++ compiler option: `--create-pch`

Menu entry

1. Select **C/C++ Compiler » Precompiled C++ Headers**.
2. Enter a filename in the **Create precompiled header file** field.

Command line syntax

`--create-pch=filename`

Description

If other conditions are satisfied, create a precompiled header file with the specified name. If `--pch` (automatic PCH mode) or `--use-pch` appears on the command line following this option, its effect is erased.

Example

To create a precompiled header file with the name `test.pch`, enter:

```
cparm --create-pch=test.pch test.cc
```

Related information

C++ compiler option `--pch` (Automatic PCH mode)

C++ compiler option `--use-pch` (Use precompiled header file)

Section 2.9, *Precompiled Headers*

C++ compiler option: --default-nocommon-tentative-definitions

Menu entry

-

Command line syntax

`--default-nocommon-tentative-definitions`

Description

In GNU C++ mode, this option prevents tentative definitions to be placed in common storage.

Related information

-

C++ compiler option: `--defer-parse-function-templates`

Menu entry

-

Command line syntax

`--defer-parse-function-templates`

`--no-defer-parse-function-templates`

Default: `--defer-parse-function-templates` in GNU C++ mode.

Description

Enable or disable deferral of prototype instantiations until the first actual instantiation of a function. This is used to permit the compilation of programs that contain definitions of unusable function templates.

It is enabled by default in GNU C++ mode.

Related information

-

C++ compiler option: --define (-D)

Menu entry

1. Select **C/C++ Compiler » Preprocessing**.

The Defined symbols box shows the symbols that are currently defined.

2. To define a new symbol, click on the **Add** button in the **Defined symbols** box.
3. Type the symbol definition (for example, `demo=1`)

Use the **Edit** and **Delete** button to change a macro definition or to remove a macro from the list.

Command line syntax

```
--define=macro_name[(parm-list)][=macro_definition]
```

```
-Dmacro_name(parm-list)[=macro_definition]
```

Description

With this option you can define a macro and specify it to the preprocessor. If you only specify a macro name (no macro definition), the macro expands as '1'.

Function-style macros can be defined by appending a macro parameter list to *macro_name*.

You can specify as many macros as you like. Simply use the **Add** button to add new macro definitions.

On the command line, you can use the option **--define (-D)** multiple times. If the command line exceeds the limit of the operating system, you can define the macros in an option file which you then must specify to the C++ compiler with the option **--option-file (-f) file**.

The definition can be tested by the preprocessor with `#if`, `#ifdef` and `#ifndef`, for conditional compilations.

Make sure you do not use a reserved keyword as a macro name, as this can lead to unexpected results.

Example

Consider the following program with conditional code to compile a demo program and a real program:

```
void main( void )
{
  #if DEMO
    demo_func(); /* compile for the demo program */
  #else
    real_func(); /* compile for the real program */
  #endif
}
```

TASKING VX-toolset for ARM User Guide

```
#endif  
}
```

You can now use a macro definition to set the DEMO flag:

```
cparm --define=DEMO test.cc  
cparm --define=DEMO=1 test.cc
```

Note that both invocations have the same effect.

The next example shows how to define a macro with arguments. Note that the macro name and definition are placed between double quotes because otherwise the spaces would indicate a new option.

```
cparm --define="MAX(A,B)=((A) > (B) ? (A) : (B))" test.cc
```

Related information

[C++ compiler option **--undefine**](#) (Remove preprocessor macro)

[C++ compiler option **--option-file**](#) (Specify an option file)

C++ compiler option: --delegating-constructors

Menu entry

-

Command line syntax

`--delegating-constructors`

Description

Enable delegating constructors (a C++11 feature).

Related information

-

C++ compiler option: `--dep-file`

Menu entry

-

Command line syntax

```
--dep-file[=file]
```

Description

With this option you tell the C++ compiler to generate dependency lines that can be used in a Makefile. In contrast to the option `--preprocess=+make`, the dependency information will be generated in addition to the normal output file.

By default, the information is written to a file with extension `.d` (one for every input file). When you specify a filename, all dependencies will be combined in the specified file.

Example

```
cparm --dep-file=test.dep test.cc
```

The C++ compiler compiles the file `test.cc`, which results in the output file `test.ic`, and generates dependency lines in the file `test.dep`.

Related information

C++ compiler option `--preprocess=+make` (Generate dependencies for make)

C++ compiler option: `--deprecated-string-conv`

Menu entry

-

Command line syntax

`--deprecated-string-conv`

Description

With this option the deprecated conversion from a string literal to `char *` is allowed. This is only meaningful when string literals are `const`.

Related information

-

C++ compiler option: --diag

Menu entry

-

Command line syntax

`--diag`

Description

With this option the C++ compiler displays a list of all diagnostic messages on `stdout` (usually your screen). The C++ compiler does not compile any files.

Related information

Section 5.3, *C++ Compiler Error Messages*

C++ compiler option: --dollar

Menu entry

-

Command line syntax

`--dollar`

Default format: No dollar signs are allowed in identifiers.

Description

Accept dollar signs in identifiers. Names like A\$VAR are allowed.

Related information

-

C++ compiler option: --embedded-c++

Menu entry

1. Select **C/C++ Compiler » Language**.
2. Enable the option **Comply to embedded C++ subset**.

Command line syntax

`--embedded-c++`

Description

The "Embedded C++" subset does not support templates, exceptions, namespaces, new-style casts, RTTI, multiple inheritance, virtual base classes, and the `mutable` keyword. Select this option when you want the C++ compiler to give an error when you use any of them in your C++ source.

Related information

-

C++ compiler option: `--endianness`

Menu entry

1. Select **Global Options**.
2. Specify the **Endianness:Little-endian mode** or **Big-endian mode**.

Command line syntax

`--endianness=endianness`

`-B`

`--big-endian`

You can specify the following *endianness*:

big	b	Big endian
little	l	Little endian (default)

Description

By default, the C++ compiler generates code for a little-endian target (least significant byte of a word at lowest byte address). With `--endianness=big` the C++ compiler generates code for a big-endian target (most significant byte of a word at lowest byte address). `-B` is an alias for option `--endianness=big`.

The macro `__BIG_ENDIAN__` is defined when this option is specified, otherwise the macro `__LITTLE_ENDIAN__` is defined.

C++ compiler option: --error-file

Menu entry

-

Command line syntax

`--error-file[=file]`

Description

With this option the C++ compiler redirects error messages to a file. If you do not specify a filename, the error file will be named after the output file with extension `.ecp`.

Example

To write errors to `errors.ecp` instead of `stderr`, enter:

```
cparm --error-file=errors.ecp test.cc
```

Related information

-

C++ compiler option: `--error-limit (-e)`

Menu entry

-

Command line syntax

`--error-limit=number`

`-enumber`

Default: `--error-limit=100`

Description

Set the error limit to *number*. The C++ compiler will abandon compilation after this number of errors (remarks and warnings are not counted). By default, the limit is 100.

Example

When you want compilation to stop when 10 errors occurred, enter:

```
cparm --error-limit=10 test.cc
```

Related information

-

C++ compiler option: `--exceptions (-x)`

Menu entry

1. Select **C/C++ Compiler » Language**.
2. Enable or disable the option **Support for C++ exception handling**.

Command line syntax

`--exceptions`
`-x`

`--no-exceptions`

Default: `--no-exceptions`

Default in C++11/C++14 mode: `--exceptions`

Description

With this option you enable or disable support for exception handling in the C++ compiler.

The macro `__EXCEPTIONS` is defined when exception handling support is enabled.

This feature is implicitly enabled in C++11 mode and C++14 mode.

Related information

C++ compiler option `--c++11` (C++11 language extensions)

C++ compiler option `--c++14` (C++14 language extensions)

C++ compiler option: `--extended-variadic-macros`

Menu entry

-

Command line syntax

`--extended-variadic-macros`

`--no-extended-variadic-macros`

Description

Enable or disable support for macros with a variable number of arguments (implies `--variadic-macros`) and allow the naming of the variable argument list.

Related information

C++ compiler option `--variadic-macros` (Allow variadic macros)

C++ compiler option: `--force-vtbl`

Menu entry

1. Select **C/C++ Compiler » Miscellaneous**.
2. Enable the option **Force definition of virtual function tables (C++)**.

Command line syntax

`--force-vtbl`

Description

Force definition of virtual function tables in cases where the heuristic used by the C++ compiler to decide on definition of virtual function tables provides no guidance.

Related information

C++ compiler option `--suppress-vtbl` (Suppress definition of virtual function tables)

C++ compiler option: `--friend-injection`

Menu entry

-

Command line syntax

`--friend-injection`

Default: `friend` names are not injected.

Description

Controls whether the name of a class or function that is declared only in `friend` declarations is visible when using the normal lookup mechanisms. When `friend` names are injected, they are visible to such lookups. When `friend` names are not injected (as required by the standard), function names are visible only when using argument-dependent lookup, and class names are never visible.

Related information

C++ compiler option `--no-arg-dep-lookup` (Disable argument dependent lookup)

C++ compiler option: --g++

Menu entry

1. Select **C/C++ Compiler » Language**.
2. Enable the option **Allow GNU C++ extensions**.

Command line syntax

`--g++`

Description

Enable GNU C++ compiler language extensions.

Related information

Section 2.2.2, *GNU C++ Mode*

C++ compiler option: --generate-move-operations

Menu entry

-

Command line syntax

`--generate-move-operations`

Description

With this option the C++ compiler generates move constructors and move assignment operators according to standard C++11 rules.

Related information

-

C++ compiler option: `--gnu-version`

Menu entry

-

Command line syntax

`--gnu-version=version`

Default: 30300 (version 3.3.0)

Description

It depends on the GNU C++ compiler version if a particular GNU extension is supported or not. With this option you set the GNU C++ compiler version that should be emulated in GNU C++ mode. Version *x.y.z* of the GNU C++ compiler is represented by the value $x*10000+y*100+z$.

Example

To specify version 3.4.1 of the GNU C++ compiler, enter:

```
cparm --g++ --gnu-version=30401 test.cc
```

Related information

[Section 2.2.2, GNU C++ Mode](#)

C++ compiler option: `--guiding-decls`

Menu entry

-

Command line syntax

`--guiding-decls`

Description

Enable recognition of "guiding declarations" of template functions. A guiding declaration is a function declaration that matches an instance of a function template but has no explicit definition (since its definition derives from the function template). For example:

```
template <class T> void f(T) { ... }  
void f(int);
```

When regarded as a guiding declaration, `f(int)` is an instance of the template; otherwise, it is an independent function for which a definition must be supplied.

Related information

C++ compiler option `--old-specializations` (Old-style template specializations)

C++ compiler option: --help (-?)

Menu entry

-

Command line syntax

`--help[=item]`

`-?`

You can specify the following arguments:

options	Show extended option descriptions
----------------	-----------------------------------

Description

Displays an overview of all command line options. When you specify an argument you can list extended information such as a list of option descriptions.

Example

The following invocations all display a list of the available command line options:

```
cparm -?  
cparm --help  
cparm
```

The following invocation displays an extended list of the available options:

```
cparm --help=options
```

Related information

-

C++ compiler option: `--ignore-std`

Menu entry

-

Command line syntax

`--ignore-std`

Description

Enable a GNU C++ compatibility feature that makes the `std` namespace a synonym for the global namespace.

Related information

-

C++ compiler option: `--implicit-extern-c-type-conversion`

Menu entry

-

Command line syntax

`--implicit-extern-c-type-conversion`

Description

Enable the implicit type conversion between pointers to `extern "C"` and `extern "C++"` function types.

Related information

-

C++ compiler option: `--implicit-include`

Menu entry

1. Select **C/C++ Compiler » Miscellaneous**.
2. Enable the option **Implicit inclusion of source files for finding templates**.

Command line syntax

`--implicit-include`

Description

Enable implicit inclusion of source files as a method of finding definitions of template entities to be instantiated.

Related information

C++ compiler option `--instantiate` (Instantiation mode)

Section 2.4, *Template Instantiation*

C++ compiler option: `--implicit-noexcept`

Menu entry

-

Command line syntax

`--implicit-noexcept`

Description

With this option destructors and deallocation functions (i.e., `operator delete` and `operator delete[]`) have implicit `noexcept` specifications if no explicit exception specification is provided.

Related information

-

C++ compiler option: `--incl-suffixes`

Menu entry

-

Command line syntax

```
--incl-suffixes=suffixes
```

Default: no extension and `.stdh`.

Description

Specifies the list of suffixes to be used when searching for an include file whose name was specified without a suffix. If a null suffix is to be allowed, it must be included in the suffix list. *suffixes* is a colon-separated list of suffixes (e.g., `":stdh"`).

Example

To allow only the suffixes `.h` and `.stdh` as include file extensions, enter:

```
cparm --incl-suffixes=h:stdh test.cc
```

Related information

C++ compiler option [--include-file](#) (Include file at the start of a compilation)

Section 5.2, *How the C++ Compiler Searches Include Files*

C++ compiler option: `--include-directory (-I)`

Menu entry

1. Select **C/C++ Compiler » Include Paths**.

The Include paths box shows the directories that are added to the search path for include files.

2. To define a new directory for the search path, click on the **Add** button in the **Include paths** box.
3. Type or select a path.

Use the **Edit** and **Delete** button to change a path or to remove a path from the list.

Command line syntax

`--include-directory=path,...`

`-Ipath,...`

Description

Add *path* to the list of directories searched for `#include` files whose names do not have an absolute pathname. You can specify multiple directories separated by commas.

Example

To add the directory `/proj/include` to the include file search path, enter:

```
cparm --include-directory=/proj/include test.cc
```

Related information

C++ compiler option `--include-file` (Include file at the start of a compilation)

C++ compiler option `--sys-include` (Add directory to system include file search path)

Section 5.2, *How the C++ Compiler Searches Include Files*

C++ compiler option: --include-file (-H)

Menu entry

1. Select **C/C++ Compiler » Preprocessing**.

The Pre-include files box shows the files that are currently included before the compilation starts.

2. To define a new file, click on the **Add** button in the **Pre-include files** box.
3. Type the full path and file name or select a file.
4. (Optional) Enable the option **Include CMSIS device register definition header file**.

Use the **Edit** and **Delete** button to change a file name or to remove a file from the list.

Command line syntax

```
--include-file=file
```

```
-Hfile
```

Description

Include the source code of the indicated file at the beginning of the compilation. This is the same as specifying `#include "file"` at the beginning of *each* of your C++ sources.

All files included with **--include-file** are processed after any of the files included with **--include-macros-file**.

The filename is searched for in the directories on the include search list.

Example

```
cparm --include-file=extra.h test1.cc test2.cc
```

The file `extra.h` is included at the beginning of both `test1.cc` and `test2.cc`.

Related information

[C++ compiler option --include-directory](#) (Add directory to include file search path)

[Section 5.2, How the C++ Compiler Searches Include Files](#)

C++ compiler option: --include-macros-file

Menu entry

-

Command line syntax

`--include-macros-file=file`

Description

Include the macros of the indicated file at the beginning of the compilation. Only the preprocessing directives from the file are evaluated. All of the actual code is discarded. The effect of this option is that any macro definitions from the specified file will be in effect when the primary source file is compiled. All of the macro-only files are processed before any of the normal includes (**--include-file**). Within each group, the files are processed in the order in which they were specified.

Related information

C++ compiler option **--include-file** (Include file at the start of a compilation)

[Section 5.2, *How the C++ Compiler Searches Include Files*](#)

C++ compiler option: --init-priority

Menu entry

-

Command line syntax

`--init-priority=number`

Default: 0

Description

Normally, the C++ compiler assigns no priority to the global initialization functions and the exact order is determined by the linker. This option sets the default priority for global initialization functions. Default value is "0". You can also set the default priority with the `#pragma init_priority`.

Values from 1 to 100 are for internal use only and should not be used. Values 101 to 65535 are available for user code. A lower number means a higher priority.

Example

```
cparm --init-priority=101 test.cc
```

Related information

-

C++ compiler option: `--inline-statement-limit`

Menu entry

-

Command line syntax

`--inline-statement-limit=number`

Default: 100

Description

With this option you can set the maximum number of statements that a routine can have and still be inlinable. The setting is somewhat arbitrary, but a limit is needed to prevent iterative inlining from exhausting memory. A value of zero allows an inlined routine to be any number of statements.

Related information

-

C++ compiler option: `--instantiate (-t)`

Menu entry

1. Select **C/C++ Compiler » Miscellaneous**.
2. Select an instantiation mode in the **Instantiation mode of external template entities** box.

Command line syntax

`--instantiate=mode`

`-tmode`

You can specify the following modes:

used

all

local

Default: `--instantiate=used`

Description

Control instantiation of external template entities. External template entities are external (that is, non-inline and non-static) template functions and template static data members. The instantiation mode determines the template entities for which code should be generated based on the template definition. Normally, when a file is compiled, template entities are instantiated wherever they are used (the linker will discard duplicate definitions). The overall instantiation mode can, however, be changed with this option. You can specify the following modes:

used	Instantiate those template entities that were used in the compilation. This will include all static data members for which there are template definitions. This is the default.
all	Instantiate all template entities declared or referenced in the compilation unit. For each fully instantiated template class, all of its member functions and static data members will be instantiated whether or not they were used. Non-member template functions will be instantiated even if the only reference was a declaration.
local	Similar to <code>--instantiate=used</code> except that the functions are given internal linkage. This is intended to provide a very simple mechanism for those getting started with templates. The compiler will instantiate the functions that are used in each compilation unit as local functions, and the program will link and run correctly (barring problems due to multiple copies of local static variables). However, one may end up with many copies of the instantiated functions, so this is not suitable for production use.

You cannot use `--instantiate=local` in conjunction with automatic template instantiation.

Related information

Section 2.4, *Template Instantiation*

C++ compiler option: `--io-streams`

Menu entry

1. Select **C/C++ Compiler » Language**.
2. Enable the option **Support for C++ I/O streams**.

Command line syntax

`--io-streams`

Description

As I/O streams require substantial resources they are disabled by default. Use this option to enable I/O streams support in the C++ library. So, when you use standard I/O, e.g. `cout`, in your C++ source, you need to specify this option.

This option also enables exception handling.

Related information

-

C++ compiler option: `--lambdas`

Menu entry

-

Command line syntax

`--lambdas`

`--no-lambdas`

Default: `--no-lambdas`

Default in C++11 mode: `--lambdas`

Description

Enable or disable support for C++11 lambdas.

This feature is implicitly enabled in C++11 mode.

Related information

C++ compiler option `--c++11` (C++11 language extensions)

C++ compiler option: `--late-tiebreaker`

Menu entry

-

Command line syntax

`--late-tiebreaker`

Default: early tiebreaker processing.

Description

Select the way that tie-breakers (e.g., cv-qualifier differences) apply in overload resolution. In "early" tie-breaker processing, the tie-breakers are considered at the same time as other measures of the goodness of the match of an argument value and the corresponding parameter type (this is the standard approach).

In "late" tie-breaker processing, tie-breakers are ignored during the initial comparison, and considered only if two functions are otherwise equally good on all arguments; the tie-breakers can then be used to choose one function over another.

Related information

-

C++ compiler option: --list-file (-L)

Menu entry

-

Command line syntax

`--list-file=file`

`-Lfile`

Default: -1

Description

Generate raw listing information in the *file*. This information is likely to be used to generate a formatted listing. The raw listing file contains raw source lines, information on transitions into and out of include files, and diagnostics generated by the C++ compiler.

Each line of the listing file begins with a key character that identifies the type of line, as follows:

- N** A normal line of source; the rest of the line is the text of the line.
- X** The expanded form of a normal line of source; the rest of the line is the text of the line. This line appears following the N line, and only if the line contains non-trivial modifications (comments are considered trivial modifications; macro expansions, line splices, and trigraphs are considered non-trivial modifications). Comments are replaced by a single space in the expanded-form line.
- S** A line of source skipped by an `#if` or the like; the rest of the line is text. Note that the `#else`, `#elif`, or `#endif` that ends a skip is marked with an N.
- L** An indication of a change in source position. The line has a format similar to the `#line` identifying directive output by the C preprocessor, that is to say

`L line_number "file-name" [key]`

where *key* is, **1** for entry into an include file, or **2** for exit from an include file, and omitted otherwise.

The first line in the raw listing file is always an L line identifying the primary input file. L lines are also output for `#line` directives (key is omitted). L lines indicate the source position of the following source line in the raw listing file.

R, W, E, or C An indication of a diagnostic (**R** for remark, **W** for warning, **E** for error, and **C** for catastrophic error). The line has the form:

```
S "file-name" line_number column-number message-text
```

where *S* is R, W, E, or C, as explained above. Errors at the end of file indicate the last line of the primary source file and a column number of zero. Command line errors are catastrophes with an empty file name ("") and a line and column number of zero. Internal errors are catastrophes with position information as usual, and message-text beginning with (internal error). When a diagnostic displays a list (e.g., all the contending routines when there is ambiguity on an overloaded call), the initial diagnostic line is followed by one or more lines with the same overall format (code letter, file name, line number, column number, and message text), but in which the code letter is the lowercase version of the code letter in the initial line. The source position in such lines is the same as that in the corresponding initial line.

Example

To write raw listing information to the file `test.lst`, enter:

```
cparm --list-file=test.lst test.cc
```

Related information

-

C++ compiler option: --long-lifetime-temps

Menu entry

-

Command line syntax

`--long-lifetime-temps`

Description

Select the lifetime for temporaries: short means to end of full expression; long means to the earliest of end of scope, end of switch clause, or the next label. Short is the default.

Related information

-

C++ compiler option: --long-long

Menu entry

-

Command line syntax

`--long-long`

Description

Permit the use of `long long` in strict mode in dialects in which it is non-standard.

Related information

-

C++ compiler option: `--lossy-conversion-warning`

Menu entry

-

Command line syntax

`--lossy-conversion-warning`

Description

With this option a warning is issued whenever a conversion occurs from one arithmetic type to a smaller one or from a floating type to an integral type.

Related information

-

C++ compiler option: `--make-target`

Menu entry

-

Command line syntax

`--make-target=name`

Description

With this option you can overrule the default target name in the make dependencies generated by the options `--preprocess=+make` (`-Em`) and `--dep-file`. The default target name is the basename of the input file, with extension `.obj`.

Example

```
cparm --preprocess=+make --make-target=mytarget.obj test.cc
```

The compiler generates dependency lines with the default target name `mytarget.obj` instead of `test.obj`.

Related information

C++ compiler option `--preprocess=+make` (Generate dependencies for make)

C++ compiler option `--dep-file` (Generate dependencies in a file)

C++ compiler option: `--max-constexpr-call-count`

Menu entry

-

Command line syntax

`--max-constexpr-call-count=value`

Default: 50000

Description

With this option you can set the maximum number of `constexpr` function and constructor calls allowed in the expansion of one top-level call.

Related information

-

C++ compiler option: `--max-constexpr-call-depth`

Menu entry

-

Command line syntax

`--max-constexpr-call-depth=value`

Default: 1000

Description

With this option you can set the maximum nesting depth of `constexpr` function and constructor calls.

Related information

-

C++ compiler option: --multibyte-chars

Menu entry

-

Command line syntax

`--multibyte-chars`

Default: multibyte character sequences are not allowed.

Description

Enable processing for multibyte character sequences in comments, string literals, and character constants. Multibyte encodings are used for character sets like the Japanese SJIS.

Related information

-

C++ compiler option: `--namespaces`

Menu entry

-

Command line syntax

`--namespaces`

`--no-namespaces`

Default: namespaces are supported.

Description

When you used option `--embedded-c++` namespaces are disabled. With option `--namespaces` you can enable support for namespaces in this case.

The macro `__NAMESPACES` is defined when namespace support is enabled.

Related information

C++ compiler option `--embedded-c++` (Embedded C++ compliancy tests)

C++ compiler option `--using-std` (Implicit use of the `std` namespace)

[Section 2.3, *Namespace Support*](#)

C++ compiler option: --no-arg-dep-lookup

Menu entry

-

Command line syntax

`--no-arg-dep-lookup`

Default: argument dependent lookup of unqualified function names is performed.

Description

With this option you disable argument dependent lookup of unqualified function names.

Related information

-

C++ compiler option: `--no-array-new-and-delete`

Menu entry

-

Command line syntax

`--no-array-new-and-delete`

Default: array new and delete are supported.

Description

Disable support for array new and delete.

The macro `__ARRAY_OPERATORS` is defined when array new and delete is enabled.

Related information

-

C++ compiler option: --no-auto-storage

Menu entry

-

Command line syntax

--no-auto-storage

Default: `auto` is a storage class specifier.

Description

Disable the traditional meaning of `auto` keyword as a storage class specifier.

Related information

C++ compiler option **--auto-type** (`auto` can be used as type specifier)

C++ compiler option: `--no-bool`

Menu entry

-

Command line syntax

`--no-bool`

Default: `bool` is recognized as a keyword.

Description

Disable recognition of the `bool` keyword.

The macro `_BOOL` is defined when `bool` is recognized as a keyword.

Related information

-

C++ compiler option: --no-class-name-injection

Menu entry

-

Command line syntax

`--no-class-name-injection`

Default: the name of a class is injected into the scope of the class (as required by the standard).

Description

Do not inject the name of a class into the scope of the class (as was true in earlier versions of the C++ language).

Related information

-

C++ compiler option: `--no-const-string-literals`

Menu entry

-

Command line syntax

`--no-const-string-literals`

Default: C++ string literals and wide string literals are `const` (as required by the standard).

Description

With this option C++ string literals and wide string literals are non-`const` (as was true in earlier versions of the C++ language).

Related information

-

C++ compiler option: **--no-dep-name**

Menu entry

-

Command line syntax

--no-dep-name

Default: dependent name processing is enabled.

Description

Disable dependent name processing; i.e., the special lookup of names used in templates as required by the C++ standard. This option implies the use of **--no-parse-templates**.

Related information

C++ compiler option **--no-parse-templates** (Disable parsing of nonclass templates)

C++ compiler option: `--no-distinct-template-signatures`

Menu entry

-

Command line syntax

`--no-distinct-template-signatures`

Description

Control whether the signatures for template functions can match those for non-template functions when the functions appear in different compilation units. By default a normal function cannot be used to satisfy the need for a template instance; e.g., a function `void f(int)` could not be used to satisfy the need for an instantiation of a template `void f(T)` with `T` set to `int`.

`--no-distinct-template-signatures` provides the older language behavior, under which a non-template function can match a template function. Also controls whether function templates may have template parameters that are not used in the function signature of the function template.

Related information

-

C++ compiler option: `--no-double (-F)`

Menu entry

1. Select **C/C++ Compiler » Language**.
2. Enable the option **Treat 'double' as 'float'**.

Command line syntax

`--no-double`

`-F`

Description

With this option you tell the C++ compiler to treat variables of the type `double` as `float`. Because the `float` type takes less space, execution speed increases and code size decreases, both at the cost of less precision.

Example

```
cparm --no-double test.cc
```

The file `test.cc` is compiled where variables of the type `double` are treated as `float`.

Related information

-

C++ compiler option: --no-enum-overloading

Menu entry

-

Command line syntax

`--no-enum-overloading`

Description

Disable support for using operator functions to overload built-in operations on enum-typed operands.

Related information

-

C++ compiler option: --no-explicit

Menu entry

-

Command line syntax

`--no-explicit`

Default: the `explicit` specifier is allowed.

Description

Disable support for the `explicit` specifier on constructor declarations.

Related information

-

C++ compiler option: `--no-extern-inline`

Menu entry

-

Command line syntax

`--no-extern-inline`

Default: `inline` functions are allowed to have external linkage.

Description

Disable support for `inline` functions with external linkage in C++. When `inline` functions are allowed to have external linkage (as required by the standard), then `extern` and `inline` are compatible specifiers on a non-member function declaration; the default linkage when `inline` appears alone is external (that is, `inline` means `extern inline` on non-member functions); and an `inline` member function takes on the linkage of its class (which is usually external). However, when `inline` functions have only internal linkage (using `--no-extern-inline`), then `extern` and `inline` are incompatible; the default linkage when `inline` appears alone is internal (that is, `inline` means `static inline` on non-member functions); and `inline` member functions have internal linkage no matter what the linkage of their class.

Related information

Section 2.6, *Extern Inline Functions*

C++ compiler option: --no-for-init-diff-warning

Menu entry

-

Command line syntax

`--no-for-init-diff-warning`

Description

Disable a warning that is issued when programs compiled without the `--old-for-init` option would have had different behavior under the old rules.

Related information

C++ compiler option `--old-for-init` (Use old for scoping rules)

C++ compiler option: `--no-implicit-typename`

Menu entry

-

Command line syntax

`--no-implicit-typename`

Default: implicit typename determination is enabled.

Description

Disable implicit determination, from context, whether a template parameter dependent name is a type or nontype.

Related information

C++ compiler option `--no-typename` (Disable the typename keyword)

C++ compiler option: --no-inlining

Menu entry

1. Select **C/C++ Compiler » Miscellaneous**.
2. Disable the option **Minimal inlining of function calls (C++)**.

Command line syntax

`--no-inlining`

Description

Disable minimal inlining of function calls.

Related information

-

C++ compiler option: `--nonconst-ref-anachronism`

Menu entry

-

Command line syntax

`--nonconst-ref-anachronism`

`--no-nonconst-ref-anachronism`

Default: `--no-nonconst-ref-anachronism`

Description

Enable or disable the anachronism of allowing a reference to `nonconst` to bind to a class rvalue of the right type. This anachronism is also enabled by the `--anachronisms` option.

Related information

C++ compiler option `--anachronisms` (Enable C++ anachronisms)

Section 2.2.3, *Anachronisms Accepted*

C++ compiler option: `--nonstd-anonymous-unions`

Menu entry

-

Command line syntax

`--nonstd-anonymous-unions`

Description

Enable extensions to the C++ anonymous union feature (including of anonymous "structs" or "classes").

Related information

-

C++ compiler option: `--nonstd-default-arg-deduction`

Menu entry

-

Command line syntax

`--nonstd-default-arg-deduction`

Description

Controls whether default arguments are retained as part of deduced function types. The C++ standard requires that default arguments not be part of deduced function types. This option changes that behavior.

Related information

-

C++ compiler option: `--nonstd-instantiation-lookup`

Menu entry

-

Command line syntax

`--nonstd-instantiation-lookup`

Description

Controls whether the lookup of names during template instantiation should, instead of the normal lookup rules, use rules that were part of the C++98 working paper for some time during the development of the standard. In this mode, names are looked up in both the namespace of the template definition and in the namespace in which a template entity was first referenced in a way that would require an instantiation.

Related information

-

C++ compiler option: `--nonstd-qualifier-deduction`

Menu entry

-

Command line syntax

`--nonstd-qualifier-deduction`

Description

Controls whether non-standard template argument deduction should be performed in the qualifier portion of a qualified name. With this feature enabled, a template argument for the template parameter `T` can be deduced in contexts like `A<T> : B` or `T : B`. The standard deduction mechanism treats these as non-deduced contexts that use the values of template parameters that were either explicitly specified or deduced elsewhere.

Related information

-

C++ compiler option: --nonstd-using-decl

Menu entry

-

Command line syntax

`--nonstd-using-decl`

Default: non-standard using declarations are not allowed.

Description

Allow a non-member using declaration that specifies an unqualified name.

Related information

-

C++ compiler option: --no-parse-templates

Menu entry

-

Command line syntax

`--no-parse-templates`

Default: parsing of nonclass templates is enabled.

Description

Disable the parsing of nonclass templates in their generic form (i.e., even if they are not really instantiated). It is done by default if dependent name processing is enabled.

Related information

C++ compiler option **`--no-dep-name`** (Disable dependent name processing)

C++ compiler option: **--no-pch-messages**

Menu entry

-

Command line syntax

--no-pch-messages

Default: a message is displayed indicating that a precompiled header file was created or used in the current compilation. For example,

```
"test.cc": creating precompiled header file "test.pch"
```

Description

Disable the display of a message indicating that a precompiled header file was created or used in the current compilation.

Related information

C++ compiler option **--pch** (Automatic PCH mode)

C++ compiler option **--use-pch** (Use precompiled header file)

C++ compiler option **--create-pch** (Create precompiled header file)

Section 2.9, *Precompiled Headers*

C++ compiler option: `--no-preprocessing-only`

Menu entry

Eclipse always does a full compilation.

Command line syntax

```
--no-preprocessing-only
```

Description

You can use this option in conjunction with the options that normally cause the C++ compiler to do preprocessing only (e.g., `--preprocess`, etc.) to specify that a full compilation should be done (not just preprocessing). When used with the implicit inclusion option, this makes it possible to generate a preprocessed output file that includes any implicitly included files.

Example

```
cparm --preprocess --implicit-include --no-preprocessing-only test.cc
```

Related information

C++ compiler option `--preprocess` (Preprocessing only)

C++ compiler option `--implicit-include` (Implicit source file inclusion)

C++ compiler option: --no-stdarg-builtin

Menu entry

-

Command line syntax

`--no-stdarg-builtin`

Description

Disable special treatment of the `stdarg.h` header. When enabled, the `stdarg.h` header is treated as a built-in, and references to its macros ("`va_start`" et al) are passed through as such in generated C code.

Related information

-

C++ compiler option: `--no-stdinc` / `--no-stdstlinc`

Menu entry

1. Select **C/C++ Compiler » Miscellaneous**.
2. Add the option `--no-stdinc` or `--no-stdstlinc` to the **Additional options** field.

Command line syntax

`--no-stdinc`

`--no-stdstlinc`

Description

With option `--no-stdinc` you tell the C++ compiler not to look in the default `include` directory relative to the installation directory, when searching for standard include files.

With option `--no-stdstlinc` you tell the C++ compiler not to look in the default `include.stl` directory relative to the installation directory, when searching for standard STL include files.

This way the C++ compiler only searches in the include file search paths you specified.

Related information

[Section 5.2, *How the C++ Compiler Searches Include Files*](#)

C++ compiler option: `--no-typename`

Menu entry

-

Command line syntax

`--no-typename`

Default: `typename` is recognized as a keyword.

Description

Disable recognition of the `typename` keyword.

Related information

C++ compiler option `--no-implicit-typename` (Disable implicit `typename` determination)

C++ compiler option: `--no-use-before-set-warnings (-j)`

Menu entry

1. Select **C/C++ Compiler » Diagnostics**.
2. Enable the option **Suppress C++ compiler "used before set" warnings**.

Command line syntax

`--no-use-before-set-warnings`

`-j`

Description

Suppress warnings on local automatic variables that are used before their values are set.

Related information

C++ compiler option `--no-warnings` (Suppress all warnings)

C++ compiler option: --no-warnings (-w)

Menu entry

1. Select **C/C++ Compiler » Diagnostics**.
2. Enable the option **Suppress all warnings**.

Command line syntax

`--no-warnings`

`-w`

Description

With this option you suppress all warning messages. Error messages are still issued.

Related information

C++ compiler option [--warnings-as-errors](#) (Treat warnings as errors)

C++ compiler option: `--nullptr`

Menu entry

-

Command line syntax

`--nullptr`

`--no-nullptr`

Default: `--no-nullptr`

Default in C++11 mode: `--nullptr`

Description

Enable or disable support for the C++11 `nullptr` keyword.

This feature is implicitly enabled in C++11 mode.

Related information

C++ compiler option `--c++11` (C++11 language extensions)

C++ compiler option: `--old-for-init`

Menu entry

-

Command line syntax

`--old-for-init`

Description

Control the scope of a declaration in a `for-init-statement`. The old (cfront-compatible) scoping rules mean the declaration is in the scope to which the `for` statement itself belongs; the default (standard-conforming) rules in effect wrap the entire `for` statement in its own implicitly generated scope.

Related information

C++ compiler option `--no-for-init-diff-warning` (Disable warning for old for-scoping)

C++ compiler option: `--old-line-commands`

Menu entry

-

Command line syntax

`--old-line-commands`

Description

When generating source output, put out `#line` directives in the form `# nnn` instead of `#line nnn`.

Example

To do preprocessing only, without comments and with old style line control information, enter:

```
cparm --preprocess --old-line-commands test.cc
```

Related information

C++ compiler option `--preprocess` (Preprocessing only)

C++ compiler option: --old-specializations

Menu entry

-

Command line syntax

`--old-specializations`

Description

Enable acceptance of old-style template specializations (that is, specializations that do not use the `template<>` syntax).

Related information

-

C++ compiler option: `--option-file (-f)`

Menu entry

-

Command line syntax

```
--option-file=file
```

```
-f file
```

Description

This option is primarily intended for command line use. Instead of typing all options on the command line, you can create an option file which contains all options and flags you want to specify. With this option you specify the option file to the C++ compiler.

Use an option file when the command line would exceed the limits of the operating system, or just to store options and save typing.

You can specify the option `--option-file` multiple times.

Format of an option file

- Multiple arguments on one line in the option file are allowed.
- To include whitespace in an argument, surround the argument with single or double quotes.
- If you want to use single quotes as part of the argument, surround the argument by double quotes and vice versa:

```
"This has a single quote ' embedded"
```

```
'This has a double quote " embedded'
```

```
'This has a double quote " and a single quote ''' embedded"
```

- When a text line reaches its length limit, use a `\` to continue the line. Whitespace between quotes is preserved.

```
"This is a continuation \  
line"
```

```
-> "This is a continuation line"
```

- It is possible to nest command line files up to 25 levels.

Example

Suppose the file `myoptions` contains the following lines:

```
--embedded-c++  
--define=DEMO=1  
test.cc
```

Specify the option file to the C++ compiler:

```
cparm --option-file=myoptions
```

This is equivalent to the following command line:

```
cparm --embedded-c++ --define=DEMO=1 test.cc
```

Related information

-

C++ compiler option: `--output (-o)`

Menu entry

Eclipse names the output file always after the C++ source file.

Command line syntax

```
--output-file=file
```

```
-o file
```

Default: module name with `.ic` suffix.

Description

With this option you can specify another filename for the output file of the C++ compiler. Without this option the basename of the C++ source file is used with extension `.ic`.

You can also use this option in combination with the option **`--preprocess (-E)`** to redirect the preprocessing output to a file.

Example

To create the file `output.ic` instead of `test.ic`, enter:

```
cparm --output=output.ic test.cc
```

To use the file `my.pre` as the preprocessing output file, enter:

```
cparm --preprocess --output=my.pre test.cc
```

Related information

C++ compiler option **`--preprocess`** (Preprocessing)

C++ compiler option: --pch

Menu entry

1. Select **C/C++ Compiler » Precompiled C++ Headers**.
2. Enable the option **Automatically use/create precompiled header file**.

Command line syntax

`--pch`

Description

Automatically use and/or create a precompiled header file. If `--use-pch` or `--create-pch` (manual PCH mode) appears on the command line following this option, its effect is erased.

Related information

C++ compiler option `--use-pch` (Use precompiled header file)

C++ compiler option `--create-pch` (Create precompiled header file)

Section 2.9, *Precompiled Headers*

C++ compiler option: `--pch-dir`

Menu entry

1. Select **C/C++ Compiler » Precompiled C++ Headers**.
2. Enter a path in the **Precompiled header file directory**.

Command line syntax

`--pch-dir=directory-name`

Description

Specify the directory in which to search for and/or create a precompiled header file. This option may be used with automatic PCH mode (`--pch`) or manual PCH mode (`--create-pch` or `--use-pch`).

Example

To use the directory `c:\usr\include\pch` to automatically create precompiled header files, enter:

```
cparm --pch-dir=c:\usr\include\pch --pch test.cc
```

Related information

C++ compiler option `--pch` (Automatic PCH mode)

C++ compiler option `--use-pch` (Use precompiled header file)

C++ compiler option `--create-pch` (Create precompiled header file)

Section 2.9, *Precompiled Headers*

C++ compiler option: `--pch-verbose`

Menu entry

-

Command line syntax

`--pch-verbose`

Description

In automatic PCH mode, for each precompiled header file that cannot be used for the current compilation, a message is displayed giving the reason that the file cannot be used.

Example

```
cparm --pch --pch-verbose test.cc
```

Related information

C++ compiler option `--pch` (Automatic PCH mode)

Section 2.9, *Precompiled Headers*

C++ compiler option: `--pending-instantiations`

Menu entry

-

Command line syntax

`--pending-instantiations=n`

where *n* is the maximum number of instantiations of a single template.

Default: 64

Description

Specifies the maximum number of instantiations of a given template that may be in process of being instantiated at a given time. This is used to detect runaway recursive instantiations. If *n* is zero, there is no limit.

Example

To specify a maximum of 32 pending instantiations, enter:

```
cparm --pending-instantiations=32 test.cc
```

Related information

Section 2.4, *Template Instantiation*

C++ compiler option: `--preprocess (-E)`

Menu entry

1. Select **C/C++ Compiler » Preprocessing**.
2. Enable the option **Store preprocessor output in <file>.pre**.
3. (Optional) Enable the option **Keep comments in preprocessor output**.
4. (Optional) Enable the option **Keep #line info in preprocessor output**.

Command line syntax

`--preprocess [=flags]`

`-E[flags]`

You can set the following flags:

+/-comments	c/C	keep comments
+/-includes	i/I	generate a list of included source files
+/-make	m/M	generate dependencies for make
+/-noline	p/P	strip #line source position information

Default: `-ECIMP`

Description

With this option you tell the C++ compiler to preprocess the C++ source. Under Eclipse the C++ compiler sends the preprocessed output to the file `name.pre` (where `name` is the name of the C++ source file to compile). Eclipse also compiles the C++ source.

On the command line, the C++ compiler sends the preprocessed file to `stdout`. To capture the information in a file, specify an output file with the option `--output`.

With `--preprocess=+comments` you tell the preprocessor to keep the comments from the C++ source file in the preprocessed output.

With `--preprocess=+includes` the C++ compiler will generate a list of all included source files. The preprocessor output is discarded.

With `--preprocess=+make` the C++ compiler will generate dependency lines that can be used in a Makefile. The preprocessor output is discarded. The default target name is the basename of the input file, with the extension `.obj`. With the option `--make-target` you can specify a target name which overrides the default target name.

When implicit inclusion of templates is enabled, the output may indicate false (but safe) dependencies unless `--no-preprocessing-only` is also used.

With **--preprocess=+noline** you tell the preprocessor to strip the #line source position information (lines starting with #line). These lines are normally processed by the assembler and not needed in the preprocessed output. When you leave these lines out, the output is easier to read.

Example

```
cparm --preprocess=+comments,-make,-noline test.cc --output=test.pre
```

The C++ compiler preprocesses the file `test.cc` and sends the output to the file `test.pre`. Comments are included but no dependencies are generated and the line source position information is not stripped from the output file.

Related information

C++ compiler option **--no-preprocessing-only** (Force full compilation)

C++ compiler option **--dep-file** (Generate dependencies in a file)

C++ compiler option **--make-target** (Specify target name for **-Em** output)

C++ compiler option: `--preserve-lvalues-with-same-type-casts`

Menu entry

-

Command line syntax

`--preserve-lvalues-with-same-type-casts`

Description

With this option a cast of an lvalue to its own type results in an lvalue (rather than an rvalue, as required by the C++ standard).

Related information

-

C++ compiler option: --remarks (-r)

Menu entry

1. Select **C/C++ Compiler » Diagnostics**.
2. Enable the option **Issue remarks on C++ code**.

Command line syntax

`--remarks`

`-r`

Description

Issue remarks, which are diagnostic messages even milder than warnings.

Related information

[Section 5.3, C++ Compiler Error Messages](#)

C++ compiler option: --remove-unnneeded-entities

Menu entry

-

Command line syntax

`--remove-unnneeded-entities`

Description

Enable an optimization to remove types, variables, routines, and related constructs that are not really needed. Something may be referenced but unneeded if it is referenced only by something that is itself unneeded; certain entities, such as global variables and routines defined in the translation unit, are always considered to be needed.

Related information

-

C++ compiler option: `--rtti`

Menu entry

1. Select **C/C++ Compiler » Language**.
2. Enable the option **Support for C++ RTTI (run-time type information)**.

Command line syntax

`--rtti`

Default: RTTI (run-time type information) features are disabled.

Description

Enable support for RTTI (run-time type information) features: `dynamic_cast`, `typeid`.

The macro `__RTTI` is defined when RTTI support is enabled.

Related information

-

C++ compiler option: --rvalue-ctor-is-not-copy-ctor

Menu entry

-

Command line syntax

`--rvalue-ctor-is-not-copy-ctor`

Description

Do not treat an rvalue (or "move") constructor as a copy constructor. In the default situation, where rvalue constructors are treated as copy constructors, a user-declared rvalue constructor will inhibit the implicit generation of a traditional copy constructor.

Related information

-

C++ compiler option: `--rvalue-refs`

Menu entry

-

Command line syntax

`--rvalue-refs`

`--no-rvalue-refs`

Default: `--no-rvalue-refs`

Default in C++11 mode: `--rvalue-refs`

Description

Enable or disable support for rvalue references.

This feature is implicitly enabled in C++11 mode.

Related information

C++ compiler option `--c++11` (C++11 language extensions)

C++ compiler option: `--schar (-s)`

Menu entry

1. Select **C/C++ Compiler » Language**.
2. Disable the option **Treat 'char' variables as unsigned**.

Command line syntax

`--schar`

`-s`

Description

With this option `char` is the same as `signed char`. This is the default.

When plain `char` is signed, the macro `__SIGNED_CHARS__` is defined.

Related information

C++ compiler option `--uchar` (Plain `char` is unsigned)

Section 1.1, *Data Types*

C++ compiler option: `--special-subscript-cost`

Menu entry

-

Command line syntax

`--special-subscript-cost`

Description

Enable a special nonstandard weighting of the conversion to the integral operand of the `[]` operator in overload resolution.

This is a compatibility feature that may be useful with some existing code. With this feature enabled, the following code compiles without error:

```
struct A {
    A();
    operator int *();
    int operator[](unsigned);
};
void main() {
    A a;
    a[0];    // Ambiguous, but allowed with this option
            // operator[] is chosen
}
```

Related information

-

C++ compiler option: `--strict (-A)`

Menu entry

1. Select **C/C++ Compiler » Language**.
2. Disable the option **Allow non-ANSI/ISO C++ features**.

Command line syntax

`--strict`

`-A`

Default: non-ANSI/ISO C++ features are enabled.

Description

Enable strict ANSI/ISO mode, which provides diagnostic messages when non-standard features are used, and disables features that conflict with ANSI/ISO C or C++. All ANSI/ISO violations are issued as errors.

Example

To enable strict ANSI mode, with error diagnostic messages, enter:

```
cparm --strict test.cc
```

Related information

C++ compiler option `--strict-warnings` (Strict ANSI/ISO mode with warnings)

C++ compiler option: `--strict-warnings` (-a)

Menu entry

-

Command line syntax

`--strict-warnings`

`-a`

Default: non-ANSI/ISO C++ features are enabled.

Description

This option is similar to the option `--strict`, but all violations are issued as warnings instead of errors.

Example

To enable strict ANSI mode, with warning diagnostic messages, enter:

```
cparm --strict-warnings test.cc
```

Related information

C++ compiler option `--strict` (Strict ANSI/ISO mode with errors)

C++ compiler option: `--suppress-vtbl`

Menu entry

1. Select **C/C++ Compiler » Miscellaneous**.
2. Enable the option **Suppress definition of virtual function tables (C++)**.

Command line syntax

`--suppress-vtbl`

Description

Suppress definition of virtual function tables in cases where the heuristic used by the C++ compiler to decide on definition of virtual function tables provides no guidance. The virtual function table for a class is defined in a compilation if the compilation contains a definition of the first non-inline non-pure virtual function of the class. For classes that contain no such function, the default behavior is to define the virtual function table (but to define it as a local static entity). The `--suppress-vtbl` option suppresses the definition of the virtual function tables for such classes, and the `--force-vtbl` option forces the definition of the virtual function table for such classes. `--force-vtbl` differs from the default behavior in that it does not force the definition to be local.

Related information

C++ compiler option `--force-vtbl` (Force definition of virtual function tables)

C++ compiler option: `--sys-include`

Menu entry

-

Command line syntax

```
--sys-include=directory,...
```

Description

Change the algorithm for searching system include files whose names do not have an absolute pathname to look in *directory*.

Example

To add the directory `c:\proj\include` to the system include file search path, enter:

```
cparm --sys-include=c:\proj\include test.cc
```

Related information

C++ compiler option `--include-directory` (Add directory to include file search path)

Section 5.2, *How the C++ Compiler Searches Include Files*

C++ compiler option: `--template-typedefs-in-diagnostics`

Menu entry

-

Command line syntax

`--template-typedefs-in-diagnostics`

Default: typedefs declared in template classes are not replaced with their underlying type.

Description

Enable the replacement of typedefs declared in template classes with their underlying type. Diagnostic messages are often more useful when such typedefs are replaced.

Related information

-

C++ compiler option: `--thumb`

Menu entry

1. Select **C/C++ Compiler » Code Generation**.
2. Enable the option **Use Thumb instruction set**.

Command line syntax

`--thumb`

Description

Generate code in Thumb mode. The Thumb instruction set is a subset of the ARM instruction set which is encoded using 16-bit instructions instead of 32-bit instructions.

The macro `__THUMB__` is defined when the Thumb mode is enabled.

Related information

-

C++ compiler option: --timing

Menu entry

-

Command line syntax

`--timing`

Default: no timing information is generated.

Description

Generate compilation timing information. This option causes the C++ compiler to display the amount of CPU time and elapsed time used by each phase of the compilation and a total for the entire compilation.

Example

```
cparm --timing test.cc
```

```
processed 180 lines at 8102 lines/min
```

Related information

-

C++ compiler option: `--trace-includes`

Menu entry

-

Command line syntax

`--trace-includes`

Description

Output a list of the names of files `#included` to the error output file. The source file is compiled normally (i.e. it is not just preprocessed) unless another option that causes preprocessing only is specified.

Example

```
cparm --trace-includes test.cc
```

```
iostream.h  
string.h
```

Related information

C++ compiler option `--preprocess` (Preprocessing only)

C++ compiler option: --type-traits-helpers

Menu entry

-

Command line syntax

--type-traits-helpers

--no-type-traits-helpers

Default: in C++ mode type traits helpers are enabled by default. In GNU C++ mode, type traits helpers are never enabled by default.

Description

Enable or disable type traits helpers (like `__is_union` and `__has_virtual_destructor`). Type traits helpers are meant to ease the implementation of ISO/IEC TR 19768.

The macro `__TYPE_TRAITS_ENABLED` is defined when type traits pseudo-functions are enabled.

Related information

-

C++ compiler option: `--uchar (-u)`

Menu entry

1. Select **C/C++ Compiler » Language**.
2. Enable the option **Treat 'char' variables as unsigned**.

Command line syntax

`--uchar`

`-u`

Description

By default `char` is the same as specifying `signed char`. With this option `char` is the same as `unsigned char`.

Related information

C++ compiler option `--schar` (Plain `char` is signed)

Section 1.1, *Data Types*

C++ compiler option: --uliterals

Menu entry

-

Command line syntax

--uliterals

Default: U-literals are not recognized.

Description

Enable recognition of U-literals (string literals of the forms `U" . . . "` and `u" . . . "`, and character literals of the forms `U' . . . '` and `u' . . . '`). In C++ mode, this also enables the C++11 `char16_t` and `char32_t` keywords.

Related information

-

C++ compiler option: `--undefine (-U)`

Menu entry

1. Select **C/C++ Compiler » Preprocessing**

The Defined symbols box shows the symbols that are currently defined.

2. To remove a defined symbol, select the symbol in the **Defined symbols** box and click on the **Delete** button.

Command line syntax

```
--undefine=macro_name
```

```
-Umacro_name
```

Description

Remove any initial definition of *macro_name* as in `#undef`. `--undefine` options are processed after all `--define` options have been processed.

You cannot undefine a predefined macro as specified in [Section 2.8, *Predefined Macros*](#), except for:

```
__STDC__
```

```
__cplusplus
```

```
__SIGNED_CHARS__
```

Example

To undefine the predefined macro `__cplusplus`:

```
cparm --undefine=__cplusplus test.cc
```

Related information

C++ compiler option `--define` (Define preprocessor macro)

[Section 2.8, *Predefined Macros*](#)

C++ compiler option: --unrestricted-unions

Menu entry

-

Command line syntax

`--unrestricted-unions`

Description

Accept C++11-style "unrestricted unions". For example, non-static data members of unions can have nontrivial constructors and destructors if you use this option.

Related information

-

C++ compiler option: `--use-pch`

Menu entry

1. Select **C/C++ Compiler » Precompiled C++ Headers**.
2. Enter a filename in the **Use precompiled header file** field.

Command line syntax

`--use-pch=filename`

Description

Use a precompiled header file of the specified name as part of the current compilation. If `--pch` (automatic PCH mode) or `--create-pch` appears on the command line following this option, its effect is erased.

Example

To use the precompiled header file with the name `test.pch`, enter:

```
cparm --use-pch=test.pch test.cc
```

Related information

[C++ compiler option `--pch`](#) (Automatic PCH mode)

[C++ compiler option `--create-pch`](#) (Create precompiled header file)

[Section 2.9, *Precompiled Headers*](#)

C++ compiler option: --user-defined-literals

Menu entry

-

Command line syntax

--user-defined-literals

Description

Allow C++11-style "user-defined literals", i.e., literals with a suffix designating an `operator` function that is to be called to produce the value of the literal, e.g., `12.34_km`, which calls `operator ""_km(12.34)`.

Related information

-

C++ compiler option: `--using-std`

Menu entry

-

Command line syntax

`--using-std`

Default: implicit use of the `std` namespace is disabled.

Description

Enable implicit use of the `std` namespace when standard header files are included. Note that this does not do the equivalent of putting a `"using namespace std;"` in the program to allow old programs to be compiled with new header files; it has a special and localized meaning related to the TASKING versions of certain header files, and is unlikely to be of much use to end-users of the TASKING C++ compiler.

Related information

C++ compiler option `--namespaces` (Support for namespaces)

Section 2.3, *Namespace Support*

C++ compiler option: `--variadic-macros`

Menu entry

-

Command line syntax

`--variadic-macros`

`--no-variadic-macros`

Default: `--no-variadic-macros`

Default in C++11 mode: `--variadic-macros`

Description

Allow or do not allow macros with a variable number of arguments.

This feature is implicitly enabled in C++11 mode.

Related information

C++ compiler option `--extended-variadic-macros` (Allow extended variadic macros)

C++ compiler option `--c++11` (C++11 language extensions)

C++ compiler option: --variadic-templates

Menu entry

-

Command line syntax

`--variadic-templates`

Description

Allow "variadic templates", a C++11 feature that allows declaration of templates with a variable number of arguments.

Related information

-

C++ compiler option: --version (-V)

Menu entry

-

Command line syntax

`--version`

`-V`

Description

Display version information. The C++ compiler ignores all other options or input files.

C++ compiler option: --vla

Menu entry

-

Command line syntax

`--vla`

Description

Enable support for variable length arrays. This allows the declaration and use of arrays of automatic storage duration with dimensions that are fixed at run-time.

C++ compiler option: **--warnings-as-errors**

Menu entry

1. Select **Global Options**.
2. Enable the option **Treat warnings as errors**.

Command line syntax

--warnings-as-errors[=*number*, ...]

Description

If the C++ compiler encounters an error, it stops compiling. When you use this option without arguments, you tell the C++ compiler to treat all warnings as errors. This means that the exit status of the C++ compiler will be non-zero after one or more compiler warnings. As a consequence, the C++ compiler now also stops after encountering a warning.

You can limit this option to specific warnings by specifying a comma-separated list of warning numbers.

Related information

C++ compiler option **--no-warnings** (Suppress all warnings)

C++ compiler option: `--wchar_t-keyword`

Menu entry

1. Select **C/C++ Compiler » Language**.
2. Enable the option **Allow the 'wchar_t' keyword (C++)**.

Command line syntax

`--wchar_t-keyword`

Default: `wchar_t` is not recognized as a keyword.

Description

Enable recognition of `wchar_t` as a keyword.

The macro `_WCHAR_T` is defined when `wchar_t` is recognized as a keyword.

Related information

-

C++ compiler option: --xref-file (-X)

Menu entry

-

Command line syntax

`--xref-file=file`

`-xfile`

Description

Generate cross-reference information in a *file*. For each reference to an identifier in the source program, a line of the form

symbol_id name X file-name line-number column-number

is written, where *X* is

- D** for definition;
- d** for declaration (that is, a declaration that is not a definition);
- M** for modification;
- A** for address taken;
- U** for used;
- C** for changed (but actually meaning used and modified in a single operation, such as an increment);
- R** for any other kind of reference, or
- E** for an error in which the kind of reference is indeterminate.

symbol-id is a unique decimal number for the symbol. The fields of the above line are separated by tab characters.

Related information

-

11.4. Assembler Options

This section lists all assembler options. All options are the same for all three assemblers, **asarm** (mixed ARM/Thumb), **asarma** (ARM only) and **asarmt** (Thumb only). In the examples we only use **asarm**.

Options in Eclipse versus options on the command line

Most command line options have an equivalent option in Eclipse but some options are only available on the command line. Eclipse invokes the assembler via the control program. Therefore, it uses the syntax of the control program to pass options and files to the assembler. If there is no equivalent option in Eclipse, you can specify a command line option in Eclipse as follows:

1. From the **Project** menu, select **Properties for**

The Properties dialog appears.

2. In the left pane, expand **C/C++ Build** and select **Settings**.

In the right pane the Settings appear.

3. On the Tool Settings tab, select **Assembler » Miscellaneous**.

4. In the **Additional options** field, enter one or more command line options.

*Because Eclipse uses the control program, Eclipse automatically precedes the option with **-Wa** to pass the option via the control program directly to the assembler.*

Note that the options you enter in the Assembler page are not only used for hand-coded assembly files, but also for the assembly files generated by the compiler.

Be aware that some command line options are not useful in Eclipse or just do not have any effect. For example, the option **-V** displays version header information and has no effect in Eclipse.

Short and long option names

Options can have both short and long names. Short option names always begin with a single minus (-) character, long option names always begin with two minus (--) characters. You can abbreviate long option names as long as it forms a unique name. You can mix short and long option names on the command line.

Options can have flags or suboptions. To switch a flag 'on', use a lowercase letter or a **+longflag**. To switch a flag off, use an uppercase letter or a **-longflag**. Separate **longflags** with commas. The following two invocations are equivalent:

```
asarm -l -LeM test.src
asarm --list-file --list-format+=symbol,-macro test.src
```

When you do not specify an option, a default value may become active.

Assembler option: **--case-insensitive (-c)**

Menu entry

1. Select **Assembler » Symbols**.
2. Enable the option **Case insensitive identifiers**.

Command line syntax

`--case-insensitive`

`-c`

Default: case sensitive

Description

With this option you tell the assembler not to distinguish between uppercase and lowercase characters. By default the assembler considers uppercase and lowercase characters as different characters.

Assembly source files that are generated by the compiler must always be assembled case sensitive. When you are writing your own assembly code, you may want to specify the case insensitive mode.

Example

When assembling case insensitive, the label `LabelName` is the same label as `labelname`.

```
asarm --case-insensitive test.src
```

Related information

-

Assembler option: `--check`

Menu entry

-

Command line syntax

`--check`

Description

With this option you can check the source code for syntax errors, without generating code. This saves time in developing your application.

The assembler reports any warnings and/or errors.

This option is available on the command line only.

Related information

C compiler option `--check` (Check syntax)

Assembler option: `--code-endianness`

Menu entry

-

Command line syntax

`--code-endianness=endianness`

You can specify the following *endianness*:

big	b	Big endian
little	l	Little endian (default)

Description

This option tells the assembler what code endianness you want, little-endian (least significant byte of a word at lowest byte code address) or big-endian (most significant byte of a word at lowest byte code address). The code endianness used must be a valid one for the architecture you are assembling for. This option is only available for ARMv7R.

Related information

Assembler option `--endianness` (Data endianness)

Assembler option: **--cpu (-C)**

Menu entry

1. Expand **C/C++ Build** and select **Processor**.
2. From the **Processor selection** list, make a selection by **Architecture**, **Core** one of the manufacturers.

Command line syntax

`--cpu=architecture`

`-Carchitecture`

You can specify the following architectures:

ARMv6M	Assemble for ARMv6-M architecture
ARMv7M	Assemble for ARMv7-M architecture
ARMv7EM	Assemble for ARMv7E-M architecture
ARMv7R	Assemble for ARMv7-R architecture

Description

With this option you specify the ARM architecture for which you create your application. The architecture determines which instructions are valid and which are not. The default architecture is ARMv7M and the complete list of supported architectures is: ARMv6-M, ARMv7-M, ARMv7E-M or ARMv7-R.

Assembly code can check the value of the option by means of the built-in function `@CPU()`.

To avoid conflicts, make sure you specify the same architecture as you did for the compiler (Eclipse and the control program do this automatically).

Related information

[Assembly function @CPU\(\)](#)

[Control program option --cpu](#) (Select architecture)

[C compiler option --cpu](#) (Select architecture)

Assembler option: **--debug-info (-g)**

Menu entry

1. Select **Assembler » Symbols**.
2. Select an option from the **Generate symbolic debug** list.

Command line syntax

--debug-info[=*flags*]

-g[*flags*]

You can set the following flags:

+/-asm	a/A	Assembly source line information
+/-hll	h/H	Pass high level language debug information (HLL)
+/-local	l/L	Assembler local symbols debug information
+/-smart	s/S	Smart debug information

Default: **--debug-info=+hll**

Default (without flags): **--debug-info=+smart**

Description

With this option you tell the assembler which kind of debug information to emit in the object file.

You cannot specify **--debug-info=+asm,+hll**. Either the assembler generates assembly source line information, or it passes HLL debug information.

When you specify **--debug-info=+smart**, the assembler selects which flags to use. If high level language information is available in the source file, the assembler passes this information (same as **--debug-info=-asm,+hll,-local**). If not, the assembler generates assembly source line information (same as **--debug-info=+asm,-hll,+local**).

With **--debug-info=AHLS** the assembler does not generate any debug information.

Related information

-

Assembler option: `--define (-D)`

Menu entry

1. Select **Assembler » Preprocessing**.

The Defined symbols box right-below shows the symbols that are currently defined.

2. To define a new symbol, click on the **Add** button in the **Defined symbols** box.
3. Type the symbol definition (for example, `demo=1`)

Use the **Edit** and **Delete** button to change a macro definition or to remove a macro from the list.

Command line syntax

```
--define=macro_name[=macro_definition]
```

```
-Dmacro_name[=macro_definition]
```

Description

With this option you can define a macro and specify it to the assembler preprocessor. If you only specify a macro name (no macro definition), the macro expands as '1'.

You can specify as many macros as you like. Simply use the **Add** button to add new macro definitions.

On the command line, use the option `--define (-D)` multiple times. If the command line exceeds the limit of the operating system, you can define the macros in an option file which you then must specify to the assembler with the option `--option-file (-f) file`.

Defining macros with this option (instead of in the assembly source) is, for example, useful in combination with conditional assembly as shown in the example below.

This option has the same effect as defining symbols via the `.DEFINE`, `.SET`, and `.EQU` directives (similar to `#define` in the C language). With the `.MACRO` directive you can define more complex macros.

Make sure you do not use a reserved keyword as a macro name, as this can lead to unexpected results.

Example

Consider the following assembly program with conditional code to assemble a demo program and a real program:

```
.IF DEMO == 1
...           ; instructions for demo application
.ELSE
...           ; instructions for the real application
.ENDIF
```

You can now use a macro definition to set the DEMO flag:

```
asarm --define=DEMO test.src
asarm --define=DEMO=1 test.src
```

Note that both invocations have the same effect.

Related information

[Assembler option **--option-file**](#) (Specify an option file)

Assembler option: `--dep-file`

Menu entry

-

Command line syntax

```
--dep-file[=file]
```

Description

With this option you tell the assembler to generate dependency lines that can be used in a Makefile. The dependency information will be generated in addition to the normal output file.

By default, the information is written to a file with extension `.d`. When you specify a filename, all dependencies will be combined in the specified file.

Example

```
asarm --dep-file=test.dep test.src
```

The assembler assembles the file `test.src`, which results in the output file `test.obj`, and generates dependency lines in the file `test.dep`.

Related information

Assembler option [--make-target](#) (Specify target name for `--dep-file` output)

Assembler option: --diag

Menu entry

1. From the **Window** menu, select **Show View » Other » TASKING » Problems**.

The Problems view is added to the current perspective.

2. In the Problems view right-click on a message.

A popup menu appears.

3. Select **Detailed Diagnostics Info**.

A dialog box appears with additional information.

Command line syntax

```
--diag=[format:]{all | nr,...}
```

You can set the following output formats:

html	HTML output.
rtf	Rich Text Format.
text	ASCII text.

Default format: text

Description

With this option you can ask for an extended description of error messages in the format you choose. The output is directed to stdout (normally your screen) and in the format you specify. You can specify the following formats: **html**, **rtf** or **text** (default). To create a file with the descriptions, you must redirect the output.

With the suboption **all**, the descriptions of all error messages are given. If you want the description of one or more selected error messages, you can specify the error message numbers, separated by commas.

Example

To display an explanation of message number 244, enter:

```
asarm --diag=244
```

This results in the following message and explanation:

```
W244: additional input files will be ignored
```

The assembler supports only a single input file. All other input files are ignored.

To write an explanation of all errors and warnings in HTML format to file `aserrors.html`, use redirection and enter:

```
asarm --diag=html:all > aserrors.html
```

Related information

[Section 6.6, *Assembler Error Messages*](#)

Assembler option: `--emit-locals`

Menu entry

1. Select **Assembler » Symbols**.
2. Enable or disable one or both of the following options:
 - Emit local EQU symbols
 - Emit mapping symbols (\$a, \$t, \$d)
 - Emit local non-EQU symbols

Command line syntax

```
--emit-locals[=flag,...]
```

You can set the following flags:

+/-equs	e/E	emit local EQU symbols
+/-mappings	m/M	emit mapping symbols (\$a, \$t, \$d)
+/-symbols	s/S	emit local non-EQU symbols

Default: `--emit-locals=+mappings,+symbols`

Description

With the option `--emit-locals=+equs` the assembler also emits local EQU symbols to the object file. Normally, only global symbols, mapping symbols and non-EQU local symbols are emitted. Having local symbols in the object file can be useful for debugging.

Mapping symbols are local symbols inside code sections which mark the start of a range of ARM instructions (\$a), a range of Thumb instructions (\$t), or a literal pool a.k.a. data pocket (\$d). Also, data sections start with a \$d symbol. The mapping symbol names are made unique with a '.' character suffix followed by a unique integer, for example: \$a.1, \$t.2 and \$d.3. This option only takes effect if local labels are emitted as well (default).

Related information

[Assembler directive `.EQU`](#)

Assembler option: `--endianness`

Menu entry

1. Select **Global Options**.
2. Specify the **Endianness:Little-endian mode** or **Big-endian mode**.

Command line syntax

`--endianness=endianness`

`-B`

`--big-endian`

You can specify the following *endianness*:

big	b	Big endian
little	l	Little endian (default)

Description

By default, the assembler generates object files with instructions and data in little-endian format (least significant byte of a word at lowest byte address). With `--endianness=big` the assembler generates object files in big-endian format (most significant byte of a word at lowest byte address). `-B` is an alias for option `--endianness=big`.

The endianness is reflected in the list file.

Assembly code can check the setting of this option by means of the built-in assembly function `@BIGENDIAN()`.

Related information

Assembly function `@BIGENDIAN()`

Assembler option `--code-endianness` (Code endianness)

Assembler option: `--error-file`

Menu entry

-

Command line syntax

`--error-file[=file]`

Description

With this option the assembler redirects error messages to a file. If you do not specify a filename, the error file will be named after the output file with extension `.ers`.

Example

To write errors to `errors.ers` instead of `stderr`, enter:

```
asarm --error-file=errors.ers test.src
```

Related information

Section 6.6, *Assembler Error Messages*

Assembler option: `--error-limit`

Menu entry

1. Select **Assembler » Diagnostics**.
2. Enter a value in the **Maximum number of emitted errors** field.

Command line syntax

```
--error-limit=number
```

Default: 42

Description

With this option you tell the assembler to only emit the specified maximum number of errors. When 0 (null) is specified, the assembler emits all errors. Without this option the maximum number of errors is 42.

Related information

Section 6.6, *Assembler Error Messages*

Assembler option: --help (-?)

Menu entry

-

Command line syntax

`--help[=item]`

`-?`

You can specify the following arguments:

options	Show extended option descriptions
----------------	-----------------------------------

Description

Displays an overview of all command line options. When you specify the argument **options** you can list detailed option descriptions.

Example

The following invocations all display a list of the available command line options:

```
asarm -?  
asarm --help  
asarm
```

To see a detailed description of the available options, enter:

```
asarm --help=options
```

Related information

-

Assembler option: `--include-directory (-I)`

Menu entry

1. Select **Assembler » Include Paths**.

The Include paths box shows the directories that are added to the search path for include files.

2. To define a new directory for the search path, click on the **Add** button in the **Include paths** box.
3. Type or select a path.

Use the **Edit** and **Delete** button to change a path or to remove a path from the list.

Command line syntax

```
--include-directory=path,...
```

```
-Ipath,...
```

Description

With this option you can specify the path where your include files are located. A relative path will be relative to the current directory,

The order in which the assembler searches for include files is:

1. The pathname in the assembly file and the directory of the assembly source.
2. The path that is specified with this option.
3. The path that is specified in the environment variable `ASARMINC` when the product was installed.
4. The default directory `$(PRODDIR)\include`.

Example

Suppose that the assembly source file `test.src` contains the following lines:

```
.INCLUDE 'myinc.inc'
```

You can call the assembler as follows:

```
asarm --include-directory=c:\proj\include test.src
```

First the assembler looks for the file `myinc.inc` in the directory where `test.src` is located. If it does not find the file, it looks in the directory `c:\proj\include` (this option). If the file is still not found, the assembler searches in the environment variable and then in the default include directory.

Related information

Assembler option **--include-file** (Include file at the start of the input file)

Assembler option: --include-file (-H)

Menu entry

1. Select **Assembler » Preprocessing**.

The Pre-include files box shows the files that are currently included before the assembling starts.

2. To define a new file, click on the **Add** button in the **Pre-include files** box.
3. Type the full path and file name or select a file.

Use the **Edit** and **Delete** button to change a file name or to remove a file from the list.

Command line syntax

```
--include-file=file,...
```

```
-Hfile,...
```

Description

With this option (set at project level) you include one extra file at the beginning of the assembly source file. The specified include file is included before all other includes. This is the same as specifying `.INCLUDE 'file'` at the beginning of your assembly source.

Example

```
asarm --include-file=myinc.inc test.src
```

The file `myinc.inc` is included at the beginning of `test.src` before it is assembled.

Related information

Assembler option [--include-directory](#) (Add directory to include file search path)

Assembler option: `--inversions`

Menu entry

1. Select **Assembler » Miscellaneous**.
2. Enable the option **Allow instruction inversions**.

Command line syntax

`--inversions`

Description

With this option you tell the assembler to try to invert some data processing instructions with an immediate operand. Inversions are available for MOV/MVN, CMP/CMN, AND/BIC, ADC/SBC, and ADD/SUB.

Example

With this option enabled, you can write

```
add r1,r2,#-4
```

and the assembler will generate

```
sub r1,r2,#4
```

and instead of

```
mov r1,0xFFFFFFFF
```

the assembler will generate

```
mvn r1,0
```

Related information

-

Assembler option: `--kanji`

Menu entry

1. Select **Assembler » Miscellaneous**.
2. Enable the option **Allow Shift JIS Kanji in strings**.

Command line syntax

`--kanji`

Description

With this option you tell the assembler to support Shift JIS encoded Kanji multi-byte characters in strings. Without this option, encodings with 0x5c as the second byte conflict with the use of the backslash as an escape character. Shift JIS in comments is supported regardless of this option.

Note that Shift JIS also includes Katakana and Hiragana.

Related information

C compiler option `--language=+kanji` (Allow Shift JIS Kanji in strings)

Assembler option: **--keep-output-files (-k)**

Menu entry

Eclipse *always* removes the object file when errors occur during assembling.

Command line syntax

--keep-output-files

-k

Description

If an error occurs during assembling, the resulting object file (`.obj`) may be incomplete or incorrect. With this option you keep the generated object file when an error occurs.

By default the assembler removes the generated object file when an error occurs. This is useful when you use the make utility. If the erroneous files are not removed, the make utility may process corrupt files on a subsequent invocation.

Use this option when you still want to use the generated object. For example when you know that a particular error does not result in a corrupt object file.

Related information

Assembler option **--warnings-as-errors** (Treat warnings as errors)

Assembler option: **--list-file (-l)**

Menu entry

1. Select **Assembler » List File**.
2. Enable the option **Generate list file**.
3. Enable or disable the types of information to be included.

Command line syntax

--list-file[=*file*]

-l[*file*]

Default: no list file is generated

Description

With this option you tell the assembler to generate a list file. A list file shows the generated object code and the relative addresses. Note that the assembler generates a relocatable object file with relative addresses.

With the optional *file* you can specify an alternative name for the list file. By default, the name of the list file is the basename of the source file with the extension `.lst`.

Related information

Assembler option **--list-format** (Format list file)

Assembler option: --list-format (-L)

Menu entry

1. Select **Assembler » List File**.
2. Enable the option **Generate list file**.
3. Enable or disable the types of information to be included.

Command line syntax

`--list-format=flag,...`

`-Lflags`

You can set the following flags:

+/-section	d/D	List section directives (.SECTION)
+/-symbol	e/E	List symbol definition directives
+/-generic-expansion	g/G	List expansion of generic instructions
+/-generic	i/I	List generic instructions
+/-line	I/L	List C preprocessor #line directives
+/-macro	m/M	List macro definitions
+/-empty-line	n/N	List empty source lines and comment lines (newline)
+/-conditional	p/P	List conditional assembly
+/-equate	q/Q	List equate and set directives (.EQU, .SET)
+/-relocations	r/R	List relocations characters ('r')
+/-hll	s/S	List HLL symbolic debug informations
+/-equate-values	v/V	List equate and set values
+/-wrap-lines	w/W	Wrap source lines
+/-macro-expansion	x/X	List macro expansions
+/-cycle-count	y/Y	List cycle counts
+/-define-expansion	z/Z	List define expansions

Use the following options for predefined sets of flags:

--list-format=0	-L0	All options disabled Alias for --list-format=DEGILMNPQRSVWXYZ
--list-format=1	-L1	All options enabled Alias for --list-format=degilmnpqrsvwxyz

Default: `--list-format=dEGilMnPqrsVwXyZ`

Description

With this option you specify which information you want to include in the list file.

On the command line you must use this option in combination with the option **--list-file (-l)**.

Related information

Assembler option **--list-file** (Generate list file)

Assembler option **--section-info=**+list**** (Display section information in list file)

Assembler option: **--make-target**

Menu entry

-

Command line syntax

--make-target=*name*

Description

With this option you can overrule the default target name in the make dependencies generated by the option **--dep-file**. The default target name is the basename of the input file, with extension `.obj`.

Example

```
asarm --dep-file --make-target=./mytarget.obj test.src
```

The assembler generates dependency lines with the default target name `./mytarget.obj` instead of `test.obj`.

Related information

Assembler option **--dep-file** (Generate dependencies in a file)

Assembler option: `--no-warnings (-w)`

Menu entry

1. Select **Assembler** » **Diagnostics**.

The Suppress warnings box shows the warnings that are currently suppressed.

2. To suppress a warning, click on the **Add** button in the **Suppress warnings** box.
3. Enter the numbers, separated by commas, of the warnings you want to suppress (for example 201, 202). Or you can use the **Add** button multiple times.
4. To suppress all warnings, enable the option **Suppress all warnings**.

Use the **Edit** and **Delete** button to change a warning number or to remove a number from the list.

Command line syntax

```
--no-warnings [=number, ... ]
```

```
-w [number, ... ]
```

Description

With this option you can suppresses all warning messages or specific warning messages.

On the command line this option works as follows:

- If you do not specify this option, all warnings are reported.
- If you specify this option but without numbers, all warnings are suppressed.
- If you specify this option with a number, only the specified warning is suppressed. You can specify the option `--no-warnings=number` multiple times.

Example

To suppress warnings 201 and 202, enter:

```
asarm test.src --no-warnings=201,202
```

Related information

Assembler option `--warnings-as-errors` (Treat warnings as errors)

Assembler option: `--old-syntax`

Menu entry

1. Select **Assembler » Miscellaneous**.
2. Disable the option **UAL syntax mode**.

Command line syntax

`--old-syntax`

Description

In UAL syntax mode the assembler will not accept instructions which use the pre-UAL syntax and will select encodings based on the UAL syntax in case both syntaxes are the same.

With this option you can change this default behavior. The assembler will run in pre-UAL mode. The built-in function `@PRE_UAL()` will return true, so you can use:

```
.IF @PRE_UAL()  
    ; <old code>  
.ELSE  
    ; <new code>  
.ENDIF
```

Related information

Assembly function `@PRE_UAL()`

Assembler option: `--option-file (-f)`

Menu entry

1. Select **Assembler » Miscellaneous**.
2. Add the option `--option-file` to the **Additional options** field.

Be aware that the options in the option file are added to the assembler options you have set in the other pages. Only in extraordinary cases you may want to use them in combination.

Command line syntax

```
--option-file=file,...
```

```
-f file,...
```

Description

This option is primarily intended for command line use. Instead of typing all options on the command line, you can create an option file which contains all options and flags you want to specify. With this option you specify the option file to the assembler.

Use an option file when the command line would exceed the limits of the operating system, or just to store options and save typing.

Option files can also be generated on the fly, for example by the make utility. You can specify the option `--option-file` multiple times.

Format of an option file

- Multiple arguments on one line in the option file are allowed.
- To include whitespace in an argument, surround the argument with single or double quotes.
- If you want to use single quotes as part of the argument, surround the argument by double quotes and vice versa:

```
"This has a single quote ' embedded"
```

```
'This has a double quote " embedded'
```

```
'This has a double quote " and a single quote ''' embedded"
```

- When a text line reaches its length limit, use a `\` to continue the line. Whitespace between quotes is preserved.

```
"This is a continuation \  
line"
```

```
-> "This is a continuation line"
```

TASKING VX-toolset for ARM User Guide

- It is possible to nest command line files up to 25 levels.

Example

Suppose the file `myoptions` contains the following lines:

```
--debug=+asm,-local  
test.src
```

Specify the option file to the assembler:

```
asarm --option-file=myoptions
```

This is equivalent to the following command line:

```
asarm --debug=+asm,-local test.src
```

Related information

-

Assembler option: --output (-o)

Menu entry

Eclipse names the output file always after the input file.

Command line syntax

```
--output=file
```

```
-o file
```

Description

With this option you can specify another filename for the output file of the assembler. Without this option, the basename of the assembly source file is used with extension `.obj`.

Example

To create the file `relobj.obj` instead of `asm.obj`, enter:

```
asarm --output=relobj.obj asm.src
```

Related information

-

Assembler option: `--page-length`

Menu entry

1. Select **Assembler » Miscellaneous**.
2. Add the option `--page-length` to the **Additional options** field.

Command line syntax

`--page-length=number`

Default: 72

Description

If you generate a list file with the assembler option `--list-file`, this option sets the number of lines in a page in the list file. The default is 72, the minimum is 10. As a special case, a page length of 0 turns off page breaks.

Related information

Assembler option `--list-file` (Generate list file)

Assembler directive `.PAGE`

Assembler option: `--page-width`

Menu entry

1. Select **Assembler » Miscellaneous**.
2. Add the option `--page-width` to the **Additional options** field.

Command line syntax

`--page-width=number`

Default: 132

Description

If you generate a list file with the assembler option `--list-file`, this option sets the number of columns per line on a page in the list file. The default is 132, the minimum is 40.

Related information

[Assembler option `--list-file`](#) (Generate list file)

[Assembler directive `.PAGE`](#)

Assembler option: **--preprocess (-E)**

Menu entry

-

Command line syntax

--preprocess

-E

Description

With this option the assembler will only preprocess the assembly source file. The assembler sends the preprocessed file to stdout.

Related information

-

Assembler option: `--preprocessor-type (-m)`

Menu entry

1. Select **Assembler » Preprocessing**.
2. Enable or disable the option **Use TASKING preprocessor**.

Command line syntax

`--preprocessor-type=type`

`-mtype`

You can set the following preprocessor types:

none	n	No preprocessor
tasking	t	TASKING preprocessor

Default: `--preprocessor-type=tasking`

Description

With this option you select the preprocessor that the assembler will use. By default, the assembler uses the TASKING preprocessor.

When the assembly source file does not contain any preprocessor symbols, you can specify to the assembler not to use a preprocessor.

Related information

-

Assembler option: `--relaxed`

Menu entry

1. Select **Assembler » Miscellaneous**.
2. Enable the option **Allow 2-operand form for 3-operand instructions**.

Command line syntax

`--relaxed`

Description

With this option you tell the assembler that a relaxed 2-operand syntax is allowed on 3-operand instructions. If the first two register operands are equal, you can replace the two registers by one.

Example

With this option enabled, instead of

```
add r1,r1,#4
```

you can write

```
add r1,#4
```

and instead of

```
add r1,r1,r2
```

you can write

```
add r1,r2
```

Related information

-

Assembler option: `--section-info (-t)`

Menu entry

1. Select **Assembler** » **List File**.
2. Enable the option **Generate list file**.
3. Enable the option **List section summary**.

and/or

1. Select **Assembler** » **Diagnostics**.
2. Enable the option **Display section summary**.

Command line syntax

```
--section-info[=flag,...]
```

```
-t[flags]
```

You can set the following flags:

+/-console	c/C	Display section summary on console
+/-list	I/L	List section summary in list file

Default: `--section-info=CL`

Default (without flags): `--section-info=c1`

Description

With this option you tell the assembler to display section information. For each section its memory space, size, total cycle counts and name is listed on stdout and/or in the list file.

The cycle count consists of two parts: the total accumulated count for the section and the total accumulated count for all repeated instructions. In the case of nested loops it is possible that the total supersedes the section total.

Example

To writes the section information to the list file and also display the section information on stdout, enter:

```
asarm --list-file --section-info asm.src
```

Related information

[Assembler option `--list-file`](#) (Generate list file)

Assembler option: `--silicon-bug`

Menu entry

1. Expand **C/C++ Build** and select **Processor**.
2. From the **Processor selection** list, select a processor.

*The **CPU problem bypasses and checks** box shows the available workarounds/checks available for the selected processor.*

3. (Optional) Select **Show all CPU problem bypasses and checks**.
4. Click **Select All** or select one or more individual options.

Command line syntax

```
--silicon-bug[=bug, ...]
```

Description

With this option you specify for which hardware problems the assembler should check. Please refer to [Chapter 19, CPU Problem Bypasses and Checks](#) for the numbers and descriptions. Silicon bug numbers are specified as a comma separated list. When this option is used without arguments, all silicon bugs are checked.

Example

To check for problem 602117, enter:

```
asarm --silicon-bug=602117 test.src
```

Related information

[Chapter 19, CPU Problem Bypasses and Checks](#)

Assembler option: `--symbol-scope (-i)`

Menu entry

1. Select **Assembler » Symbols**.
2. Enable or disable the option **Set default symbol scope to global**.

Command line syntax

`--symbol-scope=scope`

`-iscope`

You can set the following scope:

global	g	Default symbol scope is global
local	l	Default symbol scope is local

Default: `--symbol-scope=local`

Description

With this option you tell the assembler how to treat symbols that you have not specified explicitly as global or local. By default the assembler treats all symbols as local symbols unless you have defined them explicitly as global.

Related information

[Assembler directive `.GLOBAL`](#)

Assembler option: **--thumb**

Menu entry

1. Select **Assembler » Miscellaneous**.
2. Enable the option **Assemble Thumb instructions by default**.

Command line syntax

--thumb

Description

With this option you tell the assembler that the input file contains Thumb code. By default the assembler assumes that the input file contains ARM code. Specifying **--thumb** with **--cpu=ARMv7M** or with the Thumb only assembler (**asarmt**) is not required.

Note that the input may still contain mixed Thumb and ARM code because the **.ARM**, **.THUMB**, **.CODE16** and **.CODE32** directives overrule the **--thumb** option. Assembly code can check the setting of the **--thumb** option by means of the built-in assembly function **@THUMB()**. So, if you use **@THUMB()** in a **.ARM** part and you specified **--thumb**, **@THUMB()** still returns 1.

Related information

Assembly function **@THUMB()**

Assembler directives **.CODE16**, **.CODE32**, **.ARM**, **.THUMB**

Assembler option: --version (-V)

Menu entry

-

Command line syntax

`--version`

`-v`

Description

Display version information. The assembler ignores all other options or input files.

Related information

-

Assembler option: **--warnings-as-errors**

Menu entry

1. Select **Global Options**.
2. Enable the option **Treat warnings as errors**.

Command line syntax

--warnings-as-errors[=*number*, ...]

Description

If the assembler encounters an error, it stops assembling. When you use this option without arguments, you tell the assembler to treat all warnings as errors. This means that the exit status of the assembler will be non-zero after one or more assembler warnings. As a consequence, the assembler now also stops after encountering a warning.

You can limit this option to specific warnings by specifying a comma-separated list of warning numbers.

Related information

Assembler option **--no-warnings** (Suppress some or all warnings)

11.5. Linker Options

This section lists all linker options.

Options in Eclipse versus options on the command line

Most command line options have an equivalent option in Eclipse but some options are only available on the command line. Eclipse invokes the linker via the control program. Therefore, it uses the syntax of the control program to pass options and files to the linker. If there is no equivalent option in Eclipse, you can specify a command line option in Eclipse as follows:

1. From the **Project** menu, select **Properties for**

The Properties dialog appears.

2. In the left pane, expand **C/C++ Build** and select **Settings**.

In the right pane the Settings appear.

3. On the Tool Settings tab, select **Linker » Miscellaneous**.

4. In the **Additional options** field, enter one or more command line options.

*Because Eclipse uses the control program, Eclipse automatically precedes the option with **-WI** to pass the option via the control program directly to the linker.*

Be aware that some command line options are not useful in Eclipse or just do not have any effect. For example, the option **--keep-output-files** keeps files after an error occurred. When you specify this option in Eclipse, it will have no effect because Eclipse always removes the output file after an error had occurred.

Short and long option names

Options can have both short and long names. Short option names always begin with a single minus (-) character, long option names always begin with two minus (--) characters. You can abbreviate long option names as long as it forms a unique name. You can mix short and long option names on the command line.

Options can have flags or suboptions. To switch a flag 'on', use a lowercase letter or a **+longflag**. To switch a flag off, use an uppercase letter or a **-longflag**. Separate **longflags** with commas. The following two invocations are equivalent:

```
lkarm -mfkl test.obj
lkarm --map-file-format=+files,+link,+locate test.obj
```

When you do not specify an option, a default value may become active.

Linker option: **--case-insensitive**

Menu entry

1. Select **Linker » Miscellaneous**.
2. Enable the option **Link case insensitive**.

Command line syntax

--case-insensitive

Default: case sensitive

Description

With this option you tell the linker not to distinguish between uppercase and lowercase characters in symbols. By default the linker considers uppercase and lowercase characters as different characters.

Assembly source files that are generated by the compiler must *a/ways* be assembled and thus linked case sensitive. When you have written your own assembly code and specified to assemble it case insensitive, you must also link the `.obj` file case insensitive.

Related information

Assembler option **--case-insensitive**

Linker option: --chip-output (-c)

Menu entry

1. Select **Linker » Output Format**.
2. Enable the option **Generate Intel Hex format file** and/or **Generate S-records file**.
3. Enable the option **Create file for each memory chip**.
4. Optionally, specify the **Size of addresses**.

Eclipse always uses the project name as the basename for the output file.

Command line syntax

```
--chip-output=[basename]:format[:addr_size],...
```

```
-c[basename]:format[:addr_size],...
```

You can specify the following formats:

IHEX	Intel Hex
SREC	Motorola S-records

The *addr_size* specifies the size of the addresses in bytes (record length). For Intel Hex you can use the values **1**, **2** or **4** bytes (default). For Motorola-S you can specify: **2** (S1 records), **3** (S2 records) or **4** bytes (S3 records, default).

Description

With this option you specify the Intel Hex or Motorola S-record output format for loading into a PROM-programmer. The linker generates a file for each ROM memory defined in the LSL file, where sections are located:

```
memory memname
{ type=rom; }
```

The name of the file is the name of the Eclipse project or, on the command line, the name of the memory device that was emitted with extension `.hex` or `.sre`. Optionally, you can specify a *basename* which prepends the generated file name.

The linker always outputs a debugging file in ELF/DWARF format and optionally an absolute object file in Intel Hex-format and/or Motorola S-record format.

Example

To generate Intel Hex output files for each defined memory, enter the following on the command line:

```
lkarm --chip-output=myfile:IHEX test1.obj
```

TASKING VX-toolset for ARM User Guide

In this case, this generates the file `myfile_memname.hex`.

Related information

Linker option `--output` (Output file)

Linker option: `--code-endianness`

Menu entry

-

Command line syntax

```
--code-endianness=endianness
```

You can specify the following *endianness*:

big	b	Big endian
little	l	Little endian (default)

Description

This option tells the linker what code endianness you want, little-endian (least significant byte of a word at lowest byte code address) or big-endian (most significant byte of a word at lowest byte code address). The code endianness used must be a valid one for the architecture you are compiling for. This option is only available for ARMv7R.

Related information

Linker option `--endianness` (Data endianness)

Linker option: `--cpu (-C)`

Menu entry

1. Expand **C/C++ Build** and select **Processor**.
2. From the **Processor selection** list, make a selection by **Architecture**, **Core** or one of the manufacturers.

Command line syntax

`--cpu=architecture`

`-Carchitecture`

You can specify the following architectures:

ARMv6M	Link for ARMv6-M architecture
ARMv7M	Link for ARMv7-M architecture
ARMv7EM	Link for ARMv7E-M architecture
ARMv7R	Link for ARMv7-R architecture

Description

With this option you specify the ARM architecture for which you create your application. The linker uses the architecture to determine which libraries must be linked and what kind of veneers to generate. The default architecture is ARMv7M and the complete list of supported architectures is: ARMv6-M, ARMv7-M, ARMv7E-M or ARMv7-R.

Related information

C compiler option `--cpu` (Select architecture)

Linker option: **--define (-D)**

Menu entry

1. Select **Linker » Script File**.

The Defined symbols box shows the symbols that are currently defined.

2. To define a new symbol, click on the **Add** button in the **Defined symbols** box.
3. Type the symbol definition (for example, `demo=1`)

Use the **Edit** and **Delete** button to change a macro definition or to remove a macro from the list.

Command line syntax

```
--define=macro_name[=macro_definition]
```

```
-Dmacro_name[=macro_definition]
```

Description

With this option you can define a macro and specify it to the linker LSL file preprocessor. If you only specify a macro name (no macro definition), the macro expands as '1'.

You can specify as many macros as you like; just use the option **--define (-D)** multiple times. If the command line exceeds the limit of the operating system, you can define the macros in an option file which you then must specify to the linker with the option **--option-file (-f) file**.

The definition can be tested by the preprocessor with `#if`, `#ifdef` and `#ifndef`, for conditional locating.

Make sure you do not use a reserved keyword as a macro name, as this can lead to unexpected results.

Example

To define the stack size and start address which are used in the linker script file `arm.lsl`, enter:

```
lkarm test.obj -otest.abs --lsl-file=arm.lsl --define=__STACK=32k
--define=__START=0x00000000
```

Related information

Linker option **--option-file** (Specify an option file)

Linker option: `--dep-file`

Menu entry

Eclipse uses this option in the background to create a file with extension `.d` (one for every input file).

Command line syntax

```
--dep-file[=file]
```

Description

With this option you tell the linker to generate dependency lines that can be used in a Makefile. The dependency information will be generated in addition to the normal output file.

By default, the information is written to the file `lkarm.d`. When you specify a filename, all dependencies will be combined in the specified file.

Example

```
lkarm --dep-file=test.dep test.obj
```

The linker links the file `test.obj`, which results in the output file `test.abs`, and generates dependency lines in the file `test.dep`.

Related information

Linker option `--make-target` (Target to use in dependencies file)

Linker option: `--diag`

Menu entry

1. From the **Window** menu, select **Show View » Other » TASKING » Problems**.

The Problems view is added to the current perspective.

2. In the Problems view right-click on a message.

A popup menu appears.

3. Select **Detailed Diagnostics Info**.

A dialog box appears with additional information.

Command line syntax

```
--diag=[format:]{all | nr,...}
```

You can set the following output formats:

html	HTML output.
rtf	Rich Text Format.
text	ASCII text.

Default format: text

Description

With this option you can ask for an extended description of error messages in the format you choose. The output is directed to `stdout` (normally your screen) and in the format you specify. You can specify the following formats: **html**, **rtf** or **text** (default). To create a file with the descriptions, you must redirect the output.

With the suboption **all**, the descriptions of all error messages are given. If you want the description of one or more selected error messages, you can specify the error message numbers, separated by commas.

With this option the linker does not link/locate any files.

Example

To display an explanation of message number 106, enter:

```
lkarm --diag=106
```

This results in the following message and explanation:

```
E106: unresolved external: <message>
```

The linker could not resolve all external symbols.

TASKING VX-toolset for ARM User Guide

This is an error when the incremental linking option is disabled.
The <message> indicates the symbol that is unresolved.

To write an explanation of all errors and warnings in HTML format to file `lkerrors.html`, use redirection and enter:

```
lkarm --diag=html:all > lkerrors.html
```

Related information

[Section 7.10, *Linker Error Messages*](#)

Linker option: `--endianness`

Menu entry

1. Select **Global Options**.
2. Specify the **Endianness:Little-endian mode** or **Big-endian mode**.

Command line syntax

`--endianness=endianness`

`-B`

`--big-endian`

You can specify the following *endianness*:

big	b	Big endian
little	l	Little endian (default)

Description

By default, the linker links objects in little-endian mode. With `--endianness=big` you tell the linker to link the input files in big-endian mode. The endianness used must be valid for the architecture you are linking for. Depending on the endianness used, the linker links different libraries. `-B` is an alias for option `--endianness=big`.

Related information

Linker option `--code-endianness` (Code endianness)

Linker option: `--error-file`

Menu entry

-

Command line syntax

`--error-file[=file]`

Description

With this option the linker redirects error messages to a file. If you do not specify a filename, the error file is `lkarm.elk`.

Example

To write errors to `errors.elk` instead of `stderr`, enter:

```
lkarm --error-file=errors.elk test.obj
```

Related information

Section 7.10, *Linker Error Messages*

Linker option: `--error-limit`

Menu entry

1. Select **Linker » Diagnostics**.
2. Enter a value in the **Maximum number of emitted errors** field.

Command line syntax

```
--error-limit=number
```

Default: 42

Description

With this option you tell the linker to only emit the specified maximum number of errors. When 0 (null) is specified, the linker emits all errors. Without this option the maximum number of errors is 42.

Related information

[Section 7.10, *Linker Error Messages*](#)

Linker option: --extern (-e)

Menu entry

-

Command line syntax

--extern=*symbol*,...

-e*symbol*,...

Description

With this option you force the linker to consider the given symbol as an undefined reference. The linker tries to resolve this symbol, either the symbol is defined in an object file or the linker extracts the corresponding symbol definition from a library.

This option is, for example, useful if the startup code is part of a library. Because your own application does not refer to the startup code, you can force the startup code to be extracted by specifying the symbol `_START` as an unresolved external.

Example

Consider the following invocation:

```
lkarm mylib.lib
```

Nothing is linked and no output file will be produced, because there are no unresolved symbols when the linker searches through `mylib.lib`.

```
lkarm --extern=_START mylib.lib
```

In this case the linker searches for the symbol `_START` in the library and (if found) extracts the object that contains `_START`, the startup code. If this module contains new unresolved symbols, the linker looks again in `mylib.lib`. This process repeats until no new unresolved symbols are found.

Related information

[Section 7.3, *Linking with Libraries*](#)

Linker option: **--first-library-first**

Menu entry

-

Command line syntax

```
--first-library-first
```

Description

When the linker processes a library it searches for symbols that are referenced by the objects and libraries processed so far. If the library contains a definition for an unresolved reference the linker extracts the object that contains the definition from the library.

By default the linker processes object files and libraries in the order in which they appear on the command line. If you specify the option **--first-library-first** the linker always tries to take the symbol definition from the library that appears first on the command line before scanning subsequent libraries.

This is for example useful when you are working with a newer version of a library that partially overlaps the older version. Because they do not contain exactly the same functions, you have to link them both. However, when a function is present in both libraries, you may want the linker to extract the most recent function.

Example

Consider the following example:

```
lkarm --first-library-first a.lib test.obj b.lib
```

If the file `test.obj` calls a function which is both present in `a.lib` and `b.lib`, normally the function in `b.lib` would be extracted. With this option the linker first tries to extract the symbol from the first library `a.lib`.

Note that routines in `b.lib` that call other routines that are present in both `a.lib` and `b.lib` are now also resolved from `a.lib`.

Related information

Linker option **--no-rescan** (Rescan libraries to solve unresolved externals)

Linker option: **--global-type-checking**

Menu entry

-

Command line syntax

--global-type-checking

Description

Use this option when you want the linker to check the types of variable and function references against their definitions, using DWARF 2 or DWARF 3 debug information.

This check should give the same result as the C compiler when you use MIL linking.

Related information

C compiler option **--global-type-checking** (Global type checking)

Linker option: --help (-?)

Menu entry

-

Command line syntax

```
--help[=item]
```

-?

You can specify the following arguments:

options	Show extended option descriptions
----------------	-----------------------------------

Description

Displays an overview of all command line options. When you specify the argument **options** you can list detailed option descriptions.

Example

The following invocations all display a list of the available command line options:

```
lkarm -?  
lkarm --help  
lkarm
```

To see a detailed description of the available options, enter:

```
lkarm --help=options
```

Related information

-

Linker option: **--hex-format**

Menu entry

1. Select **Linker » Output Format**.
2. Enable the option **Generate Intel Hex format file**.
3. Enable or disable the option **Emit start address record**.

Command line syntax

--hex-format=*flag*, . . .

You can set the following flag:

+/-start-address **s/S** Emit start address record

Default: **--hex-format=s**

Description

With this option you can specify to emit or omit the start address record from the hex file.

Related information

Linker option **--output** (Output file)

Linker option: `--hex-record-size`

Menu entry

1. Select **Linker » Output Format**.
2. Enable the option **Generate Intel Hex format file**.
3. Select **Linker » Miscellaneous**.
4. Add the option `--hex-record-size` to the **Additional options** field.

Command line syntax

```
--hex-record-size=size
```

Default: 32

Description

With this option you can set the size (width) of the Intel Hex data records.

Related information

Linker option `--output` (Output file)

Section 16.2, *Intel Hex Record Format*

Linker option: --import-object

Menu entry

1. Select **Linker » Data Objects**.

The Data objects box shows the list of object files that are imported.

2. To add a data object, click on the **Add** button in the **Data objects** box.
3. Type or select a binary file (including its path).

Use the **Edit** and **Delete** button to change a filename or to remove a data object from the list.

Command line syntax

```
--import-object=file,...
```

Description

With this option the linker imports a binary *file* containing raw data and places it in a section. The section name is derived from the filename, in which dots are replaced by an underscore. So, when importing a file called `my.jpg`, a section with the name `my_jpg` is created. In your application you can refer to the created section by using linker labels.

Related information

[Section 7.5, Importing Binary Files](#)

Linker option: **--include-directory (-I)**

Menu entry

-

Command line syntax

--include-directory=*path*,...

-I*path*,...

Description

With this option you can specify the path where your LSL include files are located. A relative path will be relative to the current directory.

The order in which the linker searches for LSL include files is:

1. The pathname in the LSL file and the directory where the LSL file is located (only for #include files that are enclosed in "")
2. The path that is specified with this option.
3. The default directory $\$(PRODDIR)\include.lsl$.

Example

Suppose that your linker script file `mylsl.lsl` contains the following line:

```
#include "myinc.inc"
```

You can call the linker as follows:

```
lkarm --include-directory=c:\proj\include --lsl-file=mylsl.lsl test.obj
```

First the linker looks for the file `myinc.inc` in the directory where `mylsl.lsl` is located. If it does not find the file, it looks in the directory `c:\proj\include` (this option). Finally it looks in the directory $\$(PRODDIR)\include.lsl$.

Related information

Linker option **--lsl-file** (Specify linker script file)

Linker option: --incremental (-r)

Menu entry

-

Command line syntax

--incremental

-r

Description

Normally the linker links and locates the specified object files. With this option you tell the linker only to link the specified files. The linker creates a linker output file `.out`. You then can link this file again with other object files until you have reached the final linker output file that is ready for locating.

In the last pass, you call the linker without this option with the final linker output file `.out`. The linker will now locate the file.

Example

In this example, the files `test1.obj`, `test2.obj` and `test3.obj` are incrementally linked:

1. `lkarm --incremental test1.obj test2.obj --output=test.out`

test1.obj and test2.obj are linked

2. `lkarm --incremental test3.obj test.out`

test3.obj and test.out are linked, task1.out is created

3. `lkarm task1.out`

task1.out is located

Related information

[Section 7.4, Incremental Linking](#)

Linker option: **--keep-output-files (-k)**

Menu entry

Eclipse *always* removes the output files when errors occurred.

Command line syntax

--keep-output-files

-k

Description

If an error occurs during linking, the resulting output file may be incomplete or incorrect. With this option you keep the generated output files when an error occurs.

By default the linker removes the generated output file when an error occurs. This is useful when you use the make utility. If the erroneous files are not removed, the make utility may process corrupt files on a subsequent invocation.

Use this option when you still want to use the generated file. For example when you know that a particular error does not result in a corrupt object file, or when you want to inspect the output file, or send it to Altium support.

Related information

Linker option **--warnings-as-errors** (Treat warnings as errors)

Linker option: `--library (-l)`

Menu entry

1. Select **Linker » Libraries**.

The Libraries box shows the list of libraries that are linked with the project.

2. To add a library, click on the **Add** button in the **Libraries** box.
3. Type or select a library (including its path).
4. Optionally, disable the option **Link default libraries**.

Use the **Edit** and **Delete** button to change a library name or to remove a library from the list.

Command line syntax

`--library=name`

`-lname`

Description

With this option you tell the linker to use system library `name.lib`, where `name` is a string. The linker first searches for system libraries in any directories specified with `--library-directory`, then in the directories specified with the environment variables `LIBARM`, unless you used the option `--ignore-default-library-path`.

Example

To search in the system library `carmlib` (C library):

```
lkarm test.obj mylib.lib --library=carmlib
```

The linker links the file `test.obj` and first looks in library `mylib.lib` (in the current directory only), then in the system library `carmlib` to resolve unresolved symbols.

Related information

Linker option `--library-directory` (Additional search path for system libraries)

Section 7.3, *Linking with Libraries*

Linker option: **--library-directory (-L) / --ignore-default-library-path**

Menu entry

1. Select **Linker » Libraries**.

The Library search path box shows the directories that are added to the search path for library files.

2. To define a new directory for the search path, click on the **Add** button in the **Library search path** box.
3. Type or select a path.

Use the **Edit** and **Delete** button to change a path or to remove a path from the list.

Command line syntax

--library-directory=*path*,...

-L*path*,...

--ignore-default-library-path

-L

Description

With this option you can specify the path(s) where your system libraries, specified with the option **--library (-l)**, are located. If you want to specify multiple paths, use the option **--library-directory** for each separate path.

The default path is `$(PRODDIR)\lib\architecture\endianness`.

If you specify only **-L** (without a pathname) or the long option **--ignore-default-library-path**, the linker will not search the default path and also not in the paths specified in the environment variables `LIBARM`. So, the linker ignores steps 2 and 3 as listed below.

The priority order in which the linker searches for system libraries specified with the option **--library (-l)** is:

1. The path that is specified with the option **--library-directory**.
2. The path that is specified in the environment variables `LIBARM`.
3. The default directory `$(PRODDIR)\libarchitecture\endianness`.

Example

Suppose you call the linker as follows:

```
lkarm test.obj --library-directory=c:\mylibs --library=carm
```

TASKING VX-toolset for ARM User Guide

First the linker looks in the directory `c:\mylibs` for library `carmlib` (this option). If it does not find the requested libraries, it looks in the directory that is set with the environment variables `LIBARM`. Then the linker looks in the default directory `$(PRODDIR)\libarchitecture\endianness` for libraries.

Related information

Linker option **--library** (Link system library)

Linker option **--cpu** (Select architecture)

Linker option **--endianness** (Specify endianness)

Section 7.3.1, *How the Linker Searches Libraries*

Linker option: `--link-only`

Menu entry

-

Command line syntax

`--link-only`

Description

With this option you suppress the locating phase. The linker stops after linking and informs you about unresolved references.

Related information

Control program option `--create=relocatable (-cl)` (Stop after linking)

Linker option: `--long-branch-veneers`

Menu entry

1. Select **Linker » Miscellaneous**.
2. Enable the option **Generate long-branch veneers**.

Command line syntax

`--long-branch-veneers`

Description

With this option you enable the linker to generate a long-branch veneer if the target of a B (ARM only, not for Thumb), BL or BLX instruction is out-of-range. The locating process of the linker may become less efficient if this option is switched on, even if no long-branch veneers are required after all. Therefore it is better to first see if out-of-range branches are in the code (unlikely) before switching on this option.

Related information

-

Linker option: **--lsl-check**

Menu entry

-

Command line syntax

--lsl-check

Description

With this option the linker just checks the syntax of the LSL file(s) and exits. No linking or locating is performed. Use the option **--lsl-file** to specify the name of the Linker Script File you want to test.

Related information

Linker option **--lsl-file** (Linker script file)

Linker option **--lsl-dump** (Dump LSL info)

Section 7.7, *Controlling the Linker with a Script*

Linker option: **--lsl-dump**

Menu entry

-

Command line syntax

--lsl-dump[=*file*]

Description

With this option you tell the linker to dump the LSL part of the map file in a separate file, independent of the option **--map-file** (generate map file). If you do not specify a filename, the file `lkarm.ldf` is used.

Related information

Linker option **--map-file-format** (Map file formatting)

Linker option: `--lsl-file (-d)`

Menu entry

An LSL file can be generated when you create your project in Eclipse:

1. From the **File** menu, select **File » New » TASKING ARM C/C++ Project**.

The New C/C++ Project wizard appears.

2. Fill in the project settings in each dialog and click **Next >** until the **ARM Project Settings** appear.
3. Enable the option **Add linker script file to the project** and click **Finish**.

Eclipse creates your project and the file `project.lsl` in the project directory.

The LSL file can be specified in the Properties dialog:

1. Select **Linker » Script File**.
2. Specify a LSL file in the **Linker script file (.lsl)** field (default `../${ProjName}.lsl`).

Command line syntax

```
--lsl-file=file
```

```
-dfile
```

Description

A linker script file contains vital information about the core for the locating phase of the linker. A linker script file is coded in LSL and contains the following types of information:

- the architecture definition describes the core's hardware architecture.
- the memory definition describes the physical memory available in the system.
- the section layout definition describes how to locate sections in memory.

With this option you specify a linker script file to the linker. If you do not specify this option, the linker uses a default script file (`default.lsl`). You can specify the existing file `target.lsl` or the name of a manually written linker script file. You can use this option multiple times. The linker processes the LSL files in the order in which they appear on the command line.

Related information

Linker option `--lsl-check` (Check LSL file(s) and exit)

Section 7.7, *Controlling the Linker with a Script*

Linker option: `--make-target`

Menu entry

-

Command line syntax

`--make-target=name`

Description

With this option you can overrule the default target name in the make dependencies generated by the option `--dep-file`. The default target name is the basename of the input file, with extension `.abs`.

Example

```
lkarm --make-target=mytarget.abs test.obj
```

The linker generates dependency lines with the default target name `mytarget.abs` instead of `test.abs`.

Related information

Linker option `--dep-file` (Generate dependencies in a file)

Linker option: `--map-file (-M)`

Menu entry

1. Select **Linker » Map File**.
2. Enable the option **Generate XML map file format (.mapxml) for map file viewer**.
3. (Optional) Enable the option **Generate map file**.
4. Enable or disable the types of information to be included.

Command line syntax

```
--map-file[=file][:XML]
```

```
-M[file][:XML]
```

Default (Eclipse): XML map file is generated

Default (linker): no map file is generated

Description

With this option you tell the linker to generate a linker map file. If you do not specify a filename and you specified the option `--output`, the linker uses the same basename as the output file with the extension `.map`. If you did not specify the option `--output`, the linker uses the file `task1.map`. Eclipse names the `.map` file after the project.

In Eclipse the XML variant of the map file (extension `.mapxml`) is used for graphical display in the map file viewer.

A linker map file is a text file that shows how the linker has mapped the sections and symbols from the various object files (`.obj`) to the linked object file. A locate part shows the absolute position of each section. External symbols are listed per space with their absolute address, both sorted on symbol and sorted on address.

Related information

Linker option `--map-file-format` (Format map file)

Section 15.2, *Linker Map File Format*

Linker option: --map-file-format (-m)

Menu entry

1. Select **Linker » Map File**.
2. Enable the option **Generate XML map file format (.mapxml) for map file viewer**.
3. (Optional) Enable the option **Generate map file**.
4. Enable or disable the types of information to be included.

Command line syntax

`--map-file-format=flag,...`

`-mflags`

You can set the following flags:

+/-callgraph	c/C	Include call graph information
+/-removed	d/D	Include information on removed sections
+/-files	f/F	Include processed files information
+/-invocation	i/I	Include information on invocation and tools
+/-link	k/K	Include link result information
+/-locate	l/L	Include locate result information
+/-memory	m/M	Include memory usage information
+/-nonalloc	n/N	Include information of non-alloc sections
+/-overlay	o/O	Include overlay information
+/-statics	q/Q	Include module local symbols information
+/-crossref	r/R	Include cross references information
+/-lsl	s/S	Include processor and memory information
+/-rules	u/U	Include locate rules

Use the following options for predefined sets of flags:

--map-file-format=0	-m0	Link information Alias for -mCDfikLMNoQrSU
--map-file-format=1	-m1	Locate information Alias for -mCDfiKIMNoQRSU
--map-file-format=2	-m2	Most information Alias for -mcdfiklmNoQrSu

Default: `--map-file-format=2`

Description

With this option you specify which information you want to include in the map file.

On the command line you must use this option in combination with the option **--map-file (-M)**.

Related information

Linker option **--map-file** (Generate map file)

Section 15.2, *Linker Map File Format*

Linker option: `--misra-c-report`

Menu entry

-

Command line syntax

```
--misra-c-report [=file]
```

Description

With this option you tell the linker to create a MISRA C Quality Assurance report. This report lists the various modules in the project with the respective MISRA C settings at the time of compilation. If you do not specify a filename, the file *basename.mcr* is used.

Related information

C compiler option `--misrac` (MISRA C checking)

Linker option: --munch

Menu entry

-

Command line syntax

`--munch`

Description

With this option you tell the linker to activate the muncher in the pre-locate phase.

The muncher phase is a special part of the linker that creates sections containing a list of pointers to the initialization and termination routines. The list of pointers is consulted at run-time by startup code invoked from `main`, and the routines on the list are invoked at the appropriate times.

Related information

-

Linker option: **--non-romable**

Menu entry

1. Select **Linker » Miscellaneous**.
2. Enable the option **Application is not romable**.

Command line syntax

--non-romable

Description

With this option you tell the linker that the application must not be located in ROM. The linker will locate all ROM sections, including a copy table if present, in RAM. When the application is started, the data sections are re-initialized and the BSS sections are cleared as usual.

This option is, for example, useful when you want to test the application in RAM before you put the final application in ROM. This saves you the time of flashing the application in ROM over and over again.

If you want to locate your application in RAM only, without using ROM/flash resources of the chip, for example when you run the debugger in RAM only, also specify the options **--no-rom-copy** and **--user-provided-initialization-code**.

Related information

Linker option **--no-rom-copy** (Do not generate ROM copy)

Linker option **--user-provided-initialization-code** (Own initialization code, no standard copy table)

Linker option: `--no-rescan`

Menu entry

1. Select **Linker » Libraries**.
2. Disable the option **Rescan libraries to solve unresolved externals**.

Command line syntax

`--no-rescan`

Description

When the linker processes a library it searches for symbol definitions that are referenced by the objects and libraries processed so far. If the library contains a definition for an unresolved reference the linker extracts the object that contains the definition from the library. The linker processes object files and libraries in the order in which they appear on the command line.

When all objects and libraries are processed the linker checks if there are unresolved symbols left. If so, the default behavior of the linker is to rescan all libraries in the order given at the command line. The linker stops rescanning the libraries when all symbols are resolved, or when the linker could not resolve any symbol(s) during the rescan of all libraries. Notice that resolving one symbol may introduce new unresolved symbols.

With this option, you tell the linker to scan the object files and libraries only once. When the linker has not resolved all symbols after the first scan, it reports which symbols are still unresolved. This option is useful if you are building your own libraries. The libraries are most efficiently organized if the linker needs only one pass to resolve all symbols.

Related information

[Linker option `--first-library-first`](#) (Scan libraries in given order)

Linker option: **--no-rom-copy (-N)**

Menu entry

-

Command line syntax

`--no-rom-copy`

`-N`

Description

With this option the linker will not generate a ROM copy for data sections. A copy table is generated and contains entries to clear BSS sections. However, no entries to copy data sections from ROM to RAM are placed in the copy table.

The data sections are initialized when the application is downloaded. The data sections are not re-initialized when the application is restarted.

Related information

Linker option **--non-romable** (Application is not romable)

Linker option **--user-provided-initialization-code** (Own initialization code, no standard copy table)

Linker option: **--no-warnings (-w)**

Menu entry

1. Select **Linker » Diagnostics**.

The Suppress warnings box shows the warnings that are currently suppressed.

2. To suppress a warning, click on the **Add** button in the **Suppress warnings** box.
3. Enter the numbers, separated by commas, of the warnings you want to suppress (for example 135, 136). Or you can use the **Add** button multiple times.
4. To suppress all warnings, enable the option **Suppress all warnings**.

Use the **Edit** and **Delete** button to change a warning number or to remove a number from the list.

Command line syntax

```
--no-warnings [=number, ...]
```

```
-w [number, ...]
```

Description

With this option you can suppresses all warning messages or specific warning messages.

On the command line this option works as follows:

- If you do not specify this option, all warnings are reported.
- If you specify this option but without numbers, all warnings are suppressed.
- If you specify this option with a number, only the specified warning is suppressed. You can specify the option **--no-warnings=number** multiple times.

Example

To suppress warnings 135 and 136, enter:

```
lkarm --no-warnings=135,136 test.obj
```

Related information

Linker option **--warnings-as-errors** (Treat warnings as errors)

Linker option: --optimize (-O)

Menu entry

1. Select **Linker » Optimization**.
2. Select one or more of the following options:
 - Delete unreferenced sections
 - Use a 'first-fit decreasing' algorithm
 - Compress copy table
 - Delete duplicate code
 - Delete duplicate data
 - Compress ROM sections of copy table items

Command line syntax

`--optimize=flag,...`

`-Oflags`

You can set the following flags:

+/-delete-unreferenced-sections	c/C	Delete unreferenced sections from the output file
+/-first-fit-decreasing	I/L	Use a 'first-fit decreasing' algorithm to locate unrestricted sections in memory
+/-copytable-compression	t/T	Emit smart restrictions to reduce copy table size
+/-delete-duplicate-code	x/X	Delete duplicate code sections from the output file
+/-delete-duplicate-data	y/Y	Delete duplicate constant data from the output file
+/-copytable-item-compression	z/Z	Try to compress ROM sections of copy table items

Use the following options for predefined sets of flags:

--optimize=0	-O0	No optimization Alias for -OCLTXYZ
--optimize=1	-O1	Default optimization Alias for -OcLtxyZ
--optimize=2	-O2	All optimizations Alias for -OcLtxyZ

Default: `--optimize=1`

Description

With this option you can control the level of optimization.

Related information

For details about each optimization see [Section 7.6, *Linker Optimizations*](#).

Linker option: --option-file (-f)

Menu entry

1. Select **Linker » Miscellaneous**.
2. Add the option **--option-file** to the **Additional options** field.

Be aware that the options in the option file are added to the linker options you have set in the other pages. Only in extraordinary cases you may want to use them in combination.

Command line syntax

`--option-file=file,...`

`-f file,...`

Description

This option is primarily intended for command line use. Instead of typing all options on the command line, you can create an option file which contains all options and flags you want to specify. With this option you specify the option file to the linker.

Use an option file when the command line would exceed the limits of the operating system, or just to store options and save typing.

Option files can also be generated on the fly, for example by the make utility. You can specify the option **--option-file** multiple times.

Format of an option file

- Multiple arguments on one line in the option file are allowed.
- To include whitespace in an argument, surround the argument with single or double quotes.
- If you want to use single quotes as part of the argument, surround the argument by double quotes and vice versa:

```
"This has a single quote ' embedded"
```

```
'This has a double quote " embedded'
```

```
'This has a double quote " and a single quote "'" embedded"
```

- When a text line reaches its length limit, use a `\` to continue the line. Whitespace between quotes is preserved.

```
"This is a continuation \  
line"
```

```
-> "This is a continuation line"
```

- It is possible to nest command line files up to 25 levels.

Example

Suppose the file `myoptions` contains the following lines:

```
--map-file=my.map           (generate a map file)
test.obj                   (input file)
--library-directory=c:\mylibs (additional search path for system libraries)
```

Specify the option file to the linker:

```
lkarm --option-file=myoptions
```

This is equivalent to the following command line:

```
lkarm --map-file=my.map test.obj --library-directory=c:\mylibs
```

Related information

-

Linker option: **--output (-o)**

Menu entry

1. Select **Linker » Output Format**.
2. Enable one or more output formats.

For some output formats you can specify a number of suboptions.

Eclipse always uses the project name as the basename for the output file.

Command line syntax

```
--output=[filename][:format[:addr_size][,space_name]]...
```

```
-o[filename][:format[:addr_size]]...
```

You can specify the following formats:

ELF	ELF/DWARF
IHEX	Intel Hex
SREC	Motorola S-records

Description

By default, the linker generates an output file in ELF/DWARF format, with the name `task1.abs`.

With this option you can specify an alternative *filename*, and an alternative output *format*. The default output format is the format of the first input file.

You can use the **--output** option multiple times. This is useful to generate multiple output formats. With the first occurrence of the **--output** option you specify the basename (the filename without extension), which is used for subsequent **--output** options with no filename specified. If you do not specify a filename, or you do not specify the **--output** option at all, the linker uses the default basename `taskn`.

IHEX and SREC formats

If you specify the Intel Hex format or the Motorola S-records format, you can use the argument *addr_size* to specify the size of addresses in bytes (record length). For Intel Hex you can use the values: 1, 2, and 4 (default). For Motorola S-records you can specify: 2 (S1 records), 3 (S2 records, default) or 4 bytes (S3 records). Note that if you make the *addr_size* too small, the linker might give a fatal object writer error indicating an address overflow.

The name of the output file will be *filename* with the extension `.hex` or `.sre` and contains the code and data allocated in the default address space. If they exist, any other address spaces are also emitted whereas their output files are named *filename_spacename* with the extension `.hex` or `.sre`.

Use option **--chip-output (-c)** to create Intel Hex or Motorola S-record output files for each chip defined in the LSL file (suitable for loading into a PROM-programmer).

Example

To create the output file `myfile.hex` of the default address space, enter:

```
lkarm test.obj --output=myfile.hex:IHEX:4
```

Related information

Linker option **--chip-output** (Generate an output file for each chip)

Linker option **--hex-format** (Specify Hex file format settings)

Linker option: `--print-mangled-symbols (-P)`

Menu entry

-

Command line syntax

`--print-mangled-symbols`

`-P`

Description

C++ compilers generate unreadable symbol names. These symbols cannot easily be related to your C++ source file anymore. Therefore the linker will by default decode these symbols conform the IA64 ABI when printed to `stdout`. With this option you can override this default setting and print the mangled names instead.

Related information

-

Linker option: **--strip-debug (-S)**

Menu entry

1. Select **Linker » Miscellaneous**.
2. Enable the option **Strip symbolic debug information**.

Command line syntax

`--strip-debug`

`-S`

Description

With this option you specify not to include symbolic debug information in the resulting output file.

Related information

-

Linker option: **--user-provided-initialization-code (-i)**

Menu entry

1. Select **Linker » Miscellaneous**.
2. Enable the option **Do not use standard copy table for initialization**.

Command line syntax

`--user-provided-initialization-code`

`-i`

Description

It is possible to use your own initialization code, for example, to save ROM space. With this option you tell the linker *not* to generate a copy table for initialize/clear sections. Use linker labels in your source code to access the positions of the sections when located.

If the linker detects references to the TASKING initialization code, an error is emitted: it is either the TASKING initialization routine or your own, not both.

Note that the options **--no-rom-copy** and **--non-romable**, may vary independently. The 'copytable-compression' optimization (**--optimize=t**) is automatically disabled when you enable this option.

Related information

Linker option **--no-rom-copy** (Do not generate ROM copy)

Linker option **--non-romable** (Application is not romable)

Linker option **--optimize** (Specify optimization)

Linker option: `--verbose (-v)`

Menu entry

1. Select **Linker » Miscellaneous**.
2. Enable the option **Show link phases during processing**.

The verbose output is displayed in the Problems view and the Console view.

Command line syntax

`--verbose`

`-v`

Description

With this option you put the linker in *verbose* mode. The linker prints the link phases while it processes the files. The linker prints one entry for each action it executes for a task. When you use this option twice (`-vv`) you put the linker in *extra verbose* mode. In this mode the linker also prints the filenames and it shows which objects are extracted from libraries and it shows verbose information that would normally be hidden when you use the normal verbose mode or when you run without verbose. With this option you can monitor the current status of the linker.

Related information

-

Linker option: **--version (-V)**

Menu entry

-

Command line syntax

`--version`

`-V`

Description

Display version information. The linker ignores all other options or input files.

Related information

-

Linker option: `--warnings-as-errors`

Menu entry

1. Select **Global Options**.
2. Enable the option **Treat warnings as errors**.

Command line syntax

`--warnings-as-errors`[=*number*, ...]

Description

When the linker detects an error or warning, it tries to continue the link process and reports other errors and warnings. When you use this option without arguments, you tell the linker to treat all warnings as errors. This means that the exit status of the linker will be non-zero after the detection of one or more linker warnings. As a consequence, the linker will not produce any output files.

You can also limit this option to specific warnings by specifying a comma-separated list of warning numbers.

Related information

Linker option `--no-warnings` (Suppress some or all warnings)

Linker option: `--whole-archive`

Menu entry

1. Select **Linker » Miscellaneous**.
2. Add the option `--whole-archive` to the **Additional options** field.

Command line syntax

`--whole-archive=`*file*

Description

This option tells the linker to directly load all object modules in a library, as if they were placed on the command line. This is different from libraries specified as input files or with the `-l` option, which are only used to resolve references in object files that were loaded earlier.

Example

Suppose the library `myarchive.lib` contains the objects `my1.obj`, `my2.obj` and `my3.obj`. Specifying

```
lkarm --whole-archive=myarchive.lib
```

is the same as specifying

```
lkarm my1.obj my2.obj my3.obj
```

Related information

[Linker option `--library`](#) (Link system library)

11.6. Control Program Options

The control program **ccarm** facilitates the invocation of the various components of the ARM toolset from a single command line.

Options in Eclipse versus options on the command line

Eclipse invokes the compiler, assembler and linker via the control program. Therefore, it uses the syntax of the control program to pass options and files to the tools. The control program processes command line options either by itself, or, when the option is unknown to the control program, it looks whether it can pass the option to one of the other tools. However, for directly passing an option to the C++ compiler, C compiler, assembler or linker, it is recommended to use the control program options **--pass-c++**, **--pass-c**, **--pass-assembler**, **--pass-linker**.

See the previous sections for details on the options of the tools.

Short and long option names

Options can have both short and long names. Short option names always begin with a single minus (-) character, long option names always begin with two minus (--) characters. You can abbreviate long option names as long as it forms a unique name. You can mix short and long option names on the command line.

Options can have flags or suboptions. To switch a flag 'on', use a lowercase letter or a *+longflag*. To switch a flag off, use an uppercase letter or a *-longflag*. Separate *longflags* with commas. The following two invocations are equivalent:

```
ccarm -Wc-Oac test.c
ccarm --pass-c=--optimize=+coalesce,+cse test.c
```

When you do not specify an option, a default value may become active.

Control program option: `--address-size`

Menu entry

1. Select **Linker » Output Format**.
2. Enable the option **Generate Intel Hex format file** and/or **Generate S-records file**.
3. Specify the **Size of addresses**.

Eclipse always uses the project name as the basename for the output file.

Command line syntax

```
--address-size=addr_size
```

Description

If you specify IHEX or SREC with the control option `--format`, you can additionally specify the record length to be emitted in the output files.

With this option you can specify the size of the addresses in bytes (record length). For Intel Hex you can use the values **1**, **2** or **4** bytes (default). For Motorola-S you can specify: **2** (S1 records), **3** (S2 records) or **4** bytes (S3 records, default).

If you do not specify `addr_size`, the default address size is generated.

Example

To create the SREC file `test.sre` with S1 records, type:

```
ccarm --format=SREC --address-size=2 test.c
```

Related information

Control program option `--format` (Set linker output format)

Control program option `--output` (Output file)

Control program option: **--be32**

Menu entry

-

Command line syntax

--be32

Description

This option is an alias for **--endianness=big --code-endianness=big**, big-endian code and data. This option is only available for ARMv7R.

Related information

Control program option **--endianness** (Data endianness)

Control program option **--code-endianness** (Code endianness)

Control program option: **--c++11**

Menu entry

1. Select **C/C++ Compiler » Language**.
2. From the **Comply to C++ standard** list, select **ISO C++11**.

Command line syntax

--c++11

Description

Enable the C++ extensions that are defined by the C++11 standard (ISO/IEC 14882:2011). This option also enables exceptions.

Related information

Control program option **--exceptions** (Enable exceptions)

Control program option: `--c++14`

Menu entry

1. Select **C/C++ Compiler » Language**.
2. From the **Comply to C++ standard** list, select **ISO C++14**.

Command line syntax

`--c++14`

Description

Enable the C++ extensions that are defined by the C++14 standard (ISO/IEC 14882:2014). This option also enables exceptions.

Related information

Control program option `--exceptions` (Enable exceptions)

Control program option: **--check**

Menu entry

-

Command line syntax

--check

Description

With this option you can check the source code for syntax errors, without generating code. This saves time in developing your application because the code will not actually be compiled.

The compiler/assembler reports any warnings and/or errors.

This option is available on the command line only.

Related information

C compiler option **--check** (Check syntax)

Assembler option **--check** (Check syntax)

Control program option: `--code-endianness`

Menu entry

-

Command line syntax

`--code-endianness=endianness`

You can specify the following *endianness*:

big	b	Big endian
little	l	Little endian (default)

Description

This option tells the compiler what code endianness you want, little-endian (least significant byte of a word at lowest byte code address) or big-endian (most significant byte of a word at lowest byte code address). The code endianness used must be a valid one for the architecture you are compiling for. This option is only available for ARMv7R.

Related information

Control program option `--endianness` (Data endianness)

Control program option: `--cpu (-C)`

Menu entry

1. Expand **C/C++ Build** and select **Processor**.
2. From the **Processor selection** list, make a selection by **Architecture**, **Core** or one of the manufacturers.

Command line syntax

`--cpu=architecture | id | name`

`-Carchitecture | id | name`

You can specify the following architectures:

ARMv6M	Compile/assemble for ARMv6-M architecture
ARMv7M	Compile/assemble for ARMv7-M architecture
ARMv7EM	Compile/assemble for ARMv7E-M architecture
ARMv7R	Compile/assemble for ARMv7-R architecture

Description

With this option you specify the ARM architecture for which you create your application. The architecture determines which instructions are valid and which are not. The default architecture is ARMv7M and the complete list of supported architectures is: ARMv6-M, ARMv7-M, ARMv7E-M or ARMv7-R. Instead of the architecture name you can also specify the core name, like "Cortex-M3".

If you are using a vendor specific processor definition file (see the [option `--processors`](#)), you can also specify a processor. The vendor processor definition file defines for each processor its full name (for example, STM32F205RB), its ID (for example, stm32f205rb), the architecture name (for example, ARMv7M), the core settings (for example, cortexm3), the on-chip flash settings, the list of silicon bugs for that processor. Each processor also defines options to supply to the linker for preprocessing the LSL file for the applicable on-chip memory definitions (for example, `-D__FLASH_SIZE=128k`).

The lookup sequence for names specified to this option is as follows:

1. match any of the standard architecture names (as listed above, for example `ARMv7M`)
2. if none matched, match with the 'id' attribute in the processor definition file (case insensitive, for example `armv7_m`)
3. if still none matched, match with the 'name' attribute in the processor definition file (case insensitive, for example `STM32F205RB`)
4. if still none matched, the control program issues a fatal error.

If you specify a full processor name (or its ID), the control program passes the option `-D__PROC_id__` to C compiler and the linker. *id* is the 'id' attribute belonging to the processor found in one of the processor

definition files, in uppercase. The control program also passes the macros defined with the 'linker_macros' property of the processor found in the processor definition file to the linker (for example, **-D__DEVICE_LSL_FILE=stm32f2xx.lsl**).

Assembly code can check the value of the option by means of the built-in function @CPU().

Example

After

```
ccarm --processors="vendor_support_dir\etc\processors.xml"
      --cpu="STM32F205RB" -v -t test.c
```

the control program will call the tools as follows:

```
carm -CARMv7M -D__PROC_STM32F205RB__ -o test.src test.c
asarmt -CARMv7M -o test.obj test.src
lkarm -o test.abs test.obj -CARMv7M -D__PROC_STM32F205RB__
      -D__DEVICE_LSL_FILE=stm32f2xx.lsl -D__FLASH_SIZE=128k -D__SRAM_SIZE=64k
      --map-file -lctthumb -lfpthumb -lrtthumb
```

Related information

Control program option **--cpu-list** (Show list of processors)

C compiler option **--cpu** (Select architecture)

Assembler option **--cpu** (Select architecture)

Control program option **--processors** (Read additional processor definitions)

Assembly function @CPU()

Control program option: `--cpu-list`

Menu entry

-

Command line syntax

```
--cpu-list [=pattern]
```

Description

With this option the control program shows a list of supported processors as defined in the default file `processors.xml` and the optionally specified (see the [option `--processors`](#)) processors definition files. This can be useful when you want to select a processor name or id for the `--cpu` option.

The *pattern* works similar to the UNIX **grep** utility. You can use it to limit the output list.

Example

To show a list of all processors, enter:

```
ccarm --cpu-list
```

To show all processors that have `stm32f107` in their name, enter:

```
ccarm --processors="vendor_support_dir\etc\processors.xml"
      --cpu-list=stm32f107
```

```
--- ~\carm\etc\processors.xml ---
  id          name          CPU          core
--- vendor_support_dir\etc\processors.xml
  id          name          CPU          core
  stm32f107rb  STM32F107RB  ARMv7M      cortexm3
  stm32f107rc  STM32F107RC  ARMv7M      cortexm3
  stm32f107vb  STM32F107VB  ARMv7M      cortexm3
  stm32f107vc  STM32F107VC  ARMv7M      cortexm3
```

Related information

[Control program option `--cpu`](#) (Select processor)

[Control program option `--processors`](#) (Read additional processor definitions)

Control program option: **--create (-c)**

Menu entry

-

Command line syntax

--create[=*stage*]

-c[*stage*]

You can specify the following stages:

intermediate-c	c	Stop after C++ files are compiled to intermediate C files (<code>.ic</code>)
relocatable	l	Stop after the files are linked to a linker object file (<code>.out</code>)
mil	m	Stop after C++ files or C files are compiled to MIL (<code>.mil</code>)
object	o	Stop after the files are assembled to objects (<code>.obj</code>)
assembly	s	Stop after C++ files or C files are compiled to assembly (<code>.src</code>)

Default (without flags): **--create=object**

Description

Normally the control program generates an absolute object file of the specified output format from the file you supplied as input. With this option you tell the control program to stop after a certain number of phases.

Example

To generate the object file `test.obj`:

```
ccarm --create test.c
```

The control program stops after the file is assembled. It does not link nor locate the generated output.

Related information

Linker option **--link-only** (Link only, no locating)

Control program option: `--debug-info (-g)`

Menu entry

1. Select **C/C++ Compiler » Debugging**.
2. To **generate symbolic debug information**, select **Default**, **Small set** or **Full**.
To disable the generation of debug information, select **None**.

Command line syntax

`--debug-info[=suboption]`

`-g[suboption]`

You can set the following suboptions:

small	1 c	Emit small set of debug information.
default	2 d	Emit default symbolic debug information.
all	3 a	Emit full symbolic debug information.

Default: `--debug-info` (same as `--debug-info=default`)

Description

With this option you tell the control program to include debug information in the generated object file.

The control program passes the option `-gsuboption` to the C compiler and calls the assembler with `-gs`.

Related information

C compiler option `--debug-info` (Generate symbolic debug information)

Assembler option `--debug-info` (Generate symbolic debug information)

Control program option: --define (-D)

Menu entry

1. Select **C/C++ Compiler » Preprocessing** and/or **Assembler » Preprocessing**.

The Defined symbols box right-below shows the symbols that are currently defined.

2. To define a new symbol, click on the **Add** button in the **Defined symbols** box.
3. Type the symbol definition (for example, `demo=1`)

Use the **Edit** and **Delete** button to change a macro definition or to remove a macro from the list.

Command line syntax

```
--define=macro_name[=macro_definition]
```

```
-Dmacro_name[=macro_definition]
```

Description

With this option you can define a macro and specify it to the preprocessor. If you only specify a macro name (no macro definition), the macro expands as '1'.

You can specify as many macros as you like. Simply use the **Add** button to add new macro definitions.

On the command line, use the option **--define (-D)** multiple times. If the command line exceeds the limit of the operating system, you can define the macros in an option file which you then must specify to the compiler with the option **--option-file (-f) file**.

Defining macros with this option (instead of in the C source) is, for example, useful to compile conditional C source as shown in the example below.

The control program passes the option **--define (-D)** to the compiler and the assembler.

Make sure you do not use a reserved keyword as a macro name, as this can lead to unexpected results.

Example

Consider the following C program with conditional code to compile a demo program and a real program:

```
void main( void )
{
  #if DEMO
    demo_func(); /* compile for the demo program */
  #else
    real_func(); /* compile for the real program */
  #endif
}
```

TASKING VX-toolset for ARM User Guide

```
#endif  
}
```

You can now use a macro definition to set the DEMO flag:

```
ccarm --define=DEMO test.c  
ccarm --define=DEMO=1 test.c
```

Note that both invocations have the same effect.

The next example shows how to define a macro with arguments. Note that the macro name and definition are placed between double quotes because otherwise the spaces would indicate a new option.

```
ccarm --define="MAX(A,B)=((A) > (B) ? (A) : (B))" test.c
```

Related information

[Control program option **--undefine**](#) (Remove preprocessor macro)

[Control program option **--option-file**](#) (Specify an option file)

Control program option: `--dep-file`

Menu entry

-

Command line syntax

```
--dep-file[=file]
```

Description

With this option you tell the compiler to generate dependency lines that can be used in a Makefile. In contrast to the option `--preprocess=+make`, the dependency information will be generated in addition to the normal output file.

By default, the information is written to a file with extension `.d` (one for every input file). When you specify a filename, all dependencies will be combined in the specified file.

Example

```
ccarm --dep-file=test.dep -t test.c
```

The compiler compiles the file `test.c`, which results in the output file `test.src`, and generates dependency lines in the file `test.dep`.

Related information

Control program option `--preprocess=+make` (Generate dependencies for make)

Control program option: --diag

Menu entry

1. From the **Window** menu, select **Show View » Other » TASKING » Problems**.

The Problems view is added to the current perspective.

2. In the Problems view right-click on a message.

A popup menu appears.

3. Select **Detailed Diagnostics Info**.

A dialog box appears with additional information.

Command line syntax

```
--diag=[format:]{all | msg[-msg],...}
```

You can set the following output formats:

html	HTML output.
rtf	Rich Text Format.
text	ASCII text.

Default format: text

Description

With this option you can ask for an extended description of error messages in the format you choose. The output is directed to stdout (normally your screen) and in the format you specify. You can specify the following formats: **html**, **rtf** or **text** (default). To create a file with the descriptions, you must redirect the output.

With the suboption **all**, the descriptions of all error messages are given. If you want the description of one or more selected error messages, you can specify the error message numbers, separated by commas, or you can specify a range.

Example

To display an explanation of message number 103, enter:

```
ccarm --diag=103
```

This results in message 103 with explanation.

To write an explanation of all errors and warnings in HTML format to file `ccerrors.html`, use redirection and enter:

```
ccarm --diag=html:all > ccerrors.html
```

Related information

[Section 4.7, C Compiler Error Messages](#)

Control program option: `--dry-run (-n)`

Menu entry

-

Command line syntax

`--dry-run`

`-n`

Description

With this option you put the control program in verbose mode. The control program prints the invocations of the tools it would use to process the files without actually performing the steps.

Related information

Control program option `--verbose` (Verbose output)

Control program option: `--dsp-library`

Menu entry

1. Select **C/C++ Compiler » Include Paths**.
2. Enable the option **Add CMSIS include paths**.
3. Select **Linker » Libraries**.
4. Enable the option **Link CMSIS DSP library**.

Command line syntax

`--dsp-library`

Description

With this option the control program sets the C/C++ compiler macro `ARM_MATH_CM0`, `ARM_MATH_CM0PLUS`, `ARM_MATH_CM3`, `ARM_MATH_CM4` or `ARM_MATH_CM7`, depending on the selected processor. These macros are required for the CMSIS `arm_math.h` header file to operate correctly. The control program also passes the appropriate CMSIS DSP library to the linker. When MIL linking, the MIL library variant will be used.

Example

After

```
ccarm -CCortex-M3 --dsp-library -I"cmsis\Include"
      -I"cmsis\Device\ARM\ARMCM3\Include" -v -t test.c
```

the control program will call the tools as follows:

```
+ carm   -CARMv7M -D__PROC_CORTEX_M3__ -DARM_MATH_CM3 -Icmsis\Include
        -Icmsis\Device\ARM\ARMCM3\Include -o test.src test.c
+ asarmt -CARMv7M -Icmsis\Include -Icmsis\Device\ARM\ARMCM3\Include
        -o test.obj test.src
+ lkarm  -o test.abs test.obj -CARMv7M -D__PROC_CORTEX_M3__
        -D__DEVICE_LSL_FILE=cm3.lsl --map-file
        -lctthumb -lfpthumb -lrtthumb -ldspthumb
```

Related information

Section 14.1, *Using the CMSIS DSP Library*

Control program option: `--endianness`

Menu entry

1. Select **Global Options**.
2. Specify the **Endianness: Little-endian mode** or **Big-endian mode**.

Command line syntax

`--endianness=endianness`

`-B`

`--big-endian`

`--be32`

You can specify the following *endianness*:

big	b	Big endian
little	l	Little endian (default)

Description

By default, the compiler generates code for a little-endian target (least significant byte of a word at lowest byte address). With `--endianness=big` the compiler generates code for a big-endian target (most significant byte of a word at lowest byte address). `-B` is an alias for option `--endianness=big`.

`--be32` is an alias for `--endianness=big --code-endianness=big`

Related information

Control program option `--be32` (Big-endian code and data)

Control program option `--code-endianness` (Code endianness)

Control program option: `--error-file`

Menu entry

-

Command line syntax

`--error-file`

Description

With this option the control program tells the compiler, assembler and linker to redirect error messages to a file.

The error file will be named after the output file with extension `.err` (for compiler) or `.ers` (for assembler). For the linker, the error file is `lkarm.elk`.

Example

To write errors to error files instead of `stderr`, enter:

```
ccarm --error-file -t test.c
```

Related information

Control Program option [--warnings-as-errors](#) (Treat warnings as errors)

Control program option: `--exceptions`

Menu entry

1. Select **C/C++ Compiler » Language**.
2. Enable or disable the option **Support for C++ exception handling**.

Command line syntax

`--exceptions`

`--no-exceptions`

Default: `--no-exceptions`

Default in C++11/C++14 mode: `--exceptions`

Description

With this option you enable or disable support for exception handling in the C++ compiler.

The macro `__EXCEPTIONS` is defined when exception handling support is enabled.

This feature is implicitly enabled in C++11 mode and C++14 mode.

Related information

[Control program option `--c++11`](#) (C++11 language extensions)

[Control program option `--c++14`](#) (C++14 language extensions)

Control program option: `--force-c`

Menu entry

-

Command line syntax

`--force-c`

Description

With this option you tell the control program to treat all `.cc` files as C files instead of C++ files. This means that the control program does not call the C++ compiler and forces the linker to link C libraries.

Related information

Control program option `--force-c++` (Force C++ compilation and linking)

Control program option: **--force-c++**

Menu entry

Eclipse always uses this option for a C++ project.

Command line syntax

`--force-c++`

Description

With this option you tell the control program to treat all `.c` files as C++ files instead of C files. This means that the control program calls the C++ compiler prior to the C compiler and forces the linker to link C++ libraries.

Related information

Control program option **--force-c** (Treat C++ files as C files)

Control program option: --force-munch

Menu entry

Eclipse always uses this option for a C++ project.

Command line syntax

`--force-munch`

Description

With this option you force the control program to activate the muncher in the pre-locate phase.

Related information

-

Control program option: `--format`

Menu entry

1. Select **Linker » Output Format**.
2. Enable the option **Generate Intel Hex format file** and/or **Generate S-records file**.
3. Optionally, specify the **Size of addresses**.

Eclipse always uses the project name as the basename for the output file.

Command line syntax

`--format=format`

You can specify the following formats:

ELF	ELF/DWARF
IHEX	Intel Hex
SREC	Motorola S-records

Description

With this option you specify the output format for the resulting (absolute) object file. The default output format is ELF/DWARF, which can directly be used by the debugger.

If you choose IHEX or SREC, you can additionally specify the address size of the chosen format (option `--address-size`).

Example

To generate a Motorola S-record output file:

```
ccarm --format=SREC test1.c test2.c --output=test.sre
```

Related information

Control program option `--address-size` (Set address size for linker IHEX/SREC files)

Control program option `--output` (Output file)

Linker option `--chip-output` (Generate an output file for each chip)

Control program option: `--fp-model`

Menu entry

1. Select **C/C++ Compiler » Language**.
2. Enable the option **Treat 'double' as 'float'**.

Command line syntax

`--fp-model=flags`

You can set the following flags:

+/-float	f/F	treat 'double' as 'float'
+/-rewrite	r/R	allow expression rewriting
+/-negzero	z/Z	ignore sign of -0.0
	1	alias for <code>--fp-model=FRZ</code>
	2	alias for <code>--fp-model=Frz</code>
	3	alias for <code>--fp-model=frz</code>

Default: `--fp-model=Frz`

Description

With this option you select the floating-point execution model.

With `--fp-model=+float` you tell the compiler to treat variables and constants of type `double` as `float`. Because the `float` type takes less space, execution speed increases and code size decreases, both at the cost of less precision. The control program automatically selects the correct libraries.

With `--fp-model=+rewrite` you allow the compiler to rewrite expressions by reassociating. This might result in rounding differences and possibly different exceptions. An example is to rewrite $(a*c)+(b*c)$ as $(a+b)*c$.

With `--fp-model=+negzero` you allow the compiler to ignore the sign of -0.0 values. An example is to replace $(a-a)$ by zero.

Related information

Pragmas `fp_negzero` and `fp_rewrite` in [Section 1.8, Pragmas to Control the Compiler](#).

Control program option: `--fpu`

Menu entry

1. Select **C/C++ Compiler » Code Generation**.
2. Enable the option **Use FPU**.

Command line syntax

`--fpu=fpu`

You can specify the following arguments:

FPv4-sp	alias for VFPv4-sp
FPv5	alias for VFPv5
FPv5-sp	alias for VFPv5-sp
VFPv2	alias for VFPv3
VFPv3	Compile for VFPv3 architecture
VFPv3-sp	Compile for VFPv3-sp architecture
VFPv4-sp	Compile for VFPv4-sp architecture
VFPv5	Compile for VFPv5 architecture
VFPv5-sp	Compile for VFPv5-sp architecture
none	Compile for software FPU library (default)

Description

With this option you define the kind of FPU support with which you create your application. The v4 versions generate fused multiply-add operations instead of the regular compound operations. The v5 versions add VSEL, VMINNM/VMAXNM, several conversion and rounding instructions. The "sp" suffix denotes single precision floating-point only.

The macro `__FPU_fpu` is defined in the C source file. The *fpu* is converted to uppercase and the lowercase "v" and the '-' will be removed. Also when "none" is not used, the macro `__FPU_VFP` is defined in the C source file, otherwise the macro `__FPU_NONE` is defined.

Related information

-

Control program option: `--global-type-checking`

Menu entry

1. Select **C/C++ Compiler » Diagnostics**.
2. Enable the option **Perform global type checking on C code**.

Command line syntax

`--global-type-checking`

Description

The C compiler already performs type checking within each module. Use this option when you want the linker to perform type checking between modules. The control program passes this option to both the C compiler and the linker.

Related information

-

Control program option: --help (-?)

Menu entry

-

Command line syntax

`--help[=item]`

-?

You can specify the following argument:

options **o** Show extended option descriptions

Description

Displays an overview of all command line options. When you specify the argument **options** you can list detailed option descriptions.

Example

The following invocations all display a list of the available command line options:

```
ccarm -?  
ccarm --help  
ccarm
```

To see a detailed description of the available options, enter:

```
ccarm --help=options
```

Related information

-

Control program option: `--include-directory (-I)`

Menu entry

1. Select **C/C++ Compiler » Include Paths**.

The Include paths box shows the directories that are added to the search path for include files.

2. To define a new directory for the search path, click on the **Add** button in the **Include paths** box.
3. Type or select a path.
4. Optionally enable the option **Add CMSIS include paths**.

Use the **Edit** and **Delete** button to change a path or to remove a path from the list.

Command line syntax

```
--include-directory=path,...
```

```
-Ipath,...
```

Description

With this option you can specify the path where your include files are located. A relative path will be relative to the current directory.

The control program passes this option to the compiler and the assembler.

Example

Suppose that the C source file `test.c` contains the following lines:

```
#include <stdio.h>
#include "myinc.h"
```

You can call the control program as follows:

```
ccarm --include-directory=myinclude test.c
```

First the compiler looks for the file `stdio.h` in the directory `myinclude` relative to the current directory. If it was not found, the compiler searches in the environment variable and then in the default include directory.

The compiler now looks for the file `myinc.h` in the directory where `test.c` is located. If the file is not there the compiler searches in the directory `myinclude`. If it was still not found, the compiler searches in the environment variable and then in the default include directory.

Related information

[C compiler option `--include-directory`](#) (Add directory to include file search path)

C compiler option **--include-file** (Include file at the start of a compilation)

Control program option: `--instantiate`

Menu entry

1. Select **C/C++ Compiler » Miscellaneous**.
2. Select an instantiation mode in the **Instantiation mode of external template entities** box.

Command line syntax

`--instantiate=mode`

You can specify the following modes:

used

all

local

Default: `--instantiate=used`

Description

Control instantiation of external template entities. External template entities are external (that is, non-inline and non-static) template functions and template static data members. The instantiation mode determines the template entities for which code should be generated based on the template definition. Normally, when a file is compiled, template entities are instantiated wherever they are used (the linker will discard duplicate definitions). The overall instantiation mode can, however, be changed with this option. You can specify the following modes:

used	Instantiate those template entities that were used in the compilation. This will include all static data members for which there are template definitions. This is the default.
all	Instantiate all template entities declared or referenced in the compilation unit. For each fully instantiated template class, all of its member functions and static data members will be instantiated whether or not they were used. Non-member template functions will be instantiated even if the only reference was a declaration.
local	Similar to <code>--instantiate=used</code> except that the functions are given internal linkage. This is intended to provide a very simple mechanism for those getting started with templates. The compiler will instantiate the functions that are used in each compilation unit as local functions, and the program will link and run correctly (barring problems due to multiple copies of local static variables). However, one may end up with many copies of the instantiated functions, so this is not suitable for production use.

You cannot use `--instantiate=local` in conjunction with automatic template instantiation.

Related information

[Section 2.4, *Template Instantiation*](#)

Control program option: `--io-streams`

Menu entry

1. Select **C/C++ Compiler » Language**.
2. Enable the option **Support for C++ I/O streams**.

Command line syntax

`--io-streams`

Description

As I/O streams require substantial resources they are disabled by default. Use this option to enable I/O streams support in the C++ library. So, when you use standard I/O, e.g. `cout`, in your C++ source, you need to specify this option.

This option also enables exception handling.

Related information

-

Control program option: `--iso`

Menu entry

1. Select **C/C++ Compiler » Language**.
2. From the **Comply to C standard** list, select **ISO C99** or **ISO C90**.

Command line syntax

```
--iso={90 | 99}
```

Default: `--iso=99`

Description

With this option you select the ISO C standard. C90 is also referred to as the "ANSI C standard". C99 refers to the newer ISO/IEC 9899:1999 (E) standard. C99 is the default.

Independent of the chosen ISO standard, the control program always links libraries with C99 support.

Example

To select the ISO C90 standard on the command line:

```
ccarm --iso=90 test.c
```

Related information

[C compiler option `--iso` \(ISO C standard\)](#)

Control program option: **--keep-output-files (-k)**

Menu entry

Eclipse *always* removes generated output files when an error occurs.

Command line syntax

--keep-output-files

-k

Description

If an error occurs during the compilation, assembling or linking process, the resulting output file may be incomplete or incorrect. With this option you keep the generated output files when an error occurs.

By default the control program removes generated output files when an error occurs. This is useful when you use the make utility. If the erroneous files are not removed, the make utility may process corrupt files on a subsequent invocation.

Use this option when you still want to use the generated files. For example when you know that a particular error does not result in a corrupt file, or when you want to inspect the output file, or send it to Altium support.

The control program passes this option to the compiler, assembler and linker.

Example

```
ccarm --keep-output-files test.c
```

When an error occurs during compiling, assembling or linking, the erroneous generated output files will not be removed.

Related information

C compiler option **--keep-output-files**

Assembler option **--keep-output-files**

Linker option **--keep-output-files**

Control program option: `--keep-temporary-files (-t)`

Menu entry

1. Select **Global Options**.
2. Enable the option **Keep temporary files**.

Command line syntax

```
--keep-temporary-files
```

```
-t
```

Description

By default, the control program removes intermediate files like the `.src` file (result of the compiler phase) and the `.obj` file (result of the assembler phase).

With this option you tell the control program to keep temporary files it generates during the creation of the absolute object file.

Example

```
ccarm --keep-temporary-files test.c
```

The control program keeps all intermediate files it generates while creating the absolute object file `test.abs`.

Related information

-

Control program option: **--library (-l)**

Menu entry

1. Select **Linker » Libraries**.

The Libraries box shows the list of libraries that are linked with the project.

2. To add a library, click on the **Add** button in the **Libraries** box.
3. Type or select a library (including its path).
4. Optionally, disable the option **Link default libraries**.

Use the **Edit** and **Delete** button to change a library name or to remove a library from the list.

Command line syntax

--library=*name*

-l*name*

Description

With this option you tell the linker via the control program to use system library *name.lib*, where *name* is a string. The linker first searches for system libraries in any directories specified with **--library-directory**, then in the directories specified with the environment variables `LIBARM`, unless you used the option **--ignore-default-library-path**.

Example

To search in the system library `carmlib` (C library):

```
ccarm test.obj mylib.lib --library=carmlib
```

The linker links the file `test.obj` and first looks in library `mylib.lib` (in the current directory only), then in the system library `carmlib` to resolve unresolved symbols.

Related information

Control program option **--no-default-libraries** (Do not link default libraries)

Control program option **--library-directory** (Additional search path for system libraries)

Section 7.3, *Linking with Libraries*

Control program option: **--library-directory (-L) / --ignore-default-library-path**

Menu entry

1. Select **Linker » Libraries**.

The Library search path box shows the directories that are added to the search path for library files.

2. To define a new directory for the search path, click on the **Add** button in the **Library search path** box.
3. Type or select a path.

Use the **Edit** and **Delete** button to change a path or to remove a path from the list.

Command line syntax

```
--library-directory=path,...
-Lpath,...

--ignore-default-library-path
-L
```

Description

With this option you can specify the path(s) where your system libraries, specified with the option **--library (-L)**, are located. If you want to specify multiple paths, use the option **--library-directory** for each separate path.

The default path is `$(PRODDIR)\lib\architecture\endianness`.

If you specify only **-L** (without a pathname) or the long option **--ignore-default-library-path**, the linker will not search the default path and also not in the paths specified in the environment variables `LIBARM`. So, the linker ignores steps 2 and 3 as listed below.

The priority order in which the linker searches for system libraries specified with the option **--library (-L)** is:

1. The path that is specified with the option **--library-directory**.
2. The path that is specified in the environment variables `LIBARM`.
3. The default directory `$(PRODDIR)\libarchitecture\endianness`.

Example

Suppose you call the control program as follows:

```
ccarm test.c --library-directory=c:\mylibs --library=carm
```

TASKING VX-toolset for ARM User Guide

First the linker looks in the directory `c:\mylibs` for library `carmlib` (this option). If it does not find the requested libraries, it looks in the directory that is set with the environment variables `LIBARM`. Then the linker looks in the default directory `$(PRODDIR)\libarchitecture\endianness` for libraries.

Related information

Control program option **--library** (Link system library)

Section 7.3.1, *How the Linker Searches Libraries*

Control program option: **--link-only**

Menu entry

-

Command line syntax

--link-only

Description

With this option you suppress the locating phase. The linker stops after linking and informs you about unresolved references.

Related information

Control program option **--create=relocatable (-cl)** (Stop after linking)

Linker option **--link-only** (Link only, no locating)

Control program option: **--list-files**

Menu entry

-

Command line syntax

--list-files[=*file*]

Default: no list files are generated

Description

With this option you tell the assembler via the control program to generate a list file for each specified input file. A list file shows the generated object code and the relative addresses. Note that the assembler generates a relocatable object file with relative addresses.

With the optional *file* you can specify a name for the list file. This is only possible if you specify only one input file to the control program. If you do not specify a file name, or you specify more than one input file, the control program names the generated list file(s) after the specified input file(s) with extension `.lst`.

Note that object files and library files are not counted as input files.

Related information

Assembler option **--list-file** (Generate list file)

Assembler option **--list-format** (Format list file)

Control program option: `--lsl-file (-d)`

Menu entry

An LSL file can be generated when you create your project in Eclipse:

1. From the **File** menu, select **File » New » TASKING ARM C/C++ Project**.
The New C/C++ Project wizard appears.
2. Fill in the project settings in each dialog and click **Next >** until the **ARM Project Settings** appear.
3. Enable the option **Add linker script file to the project** and click **Finish**.
Eclipse creates your project and the file `project.lsl` in the project directory.

The LSL file can be specified in the Properties dialog:

1. Select **Linker » Script File**.
2. Specify a LSL file in the **Linker script file (.lsl)** field (default `../${ProjName}.lsl`).

Command line syntax

```
--lsl-file=file,...
```

```
-dfile,...
```

Description

A linker script file contains vital information about the core for the locating phase of the linker. A linker script file is coded in LSL and contains the following types of information:

- the architecture definition describes the core's hardware architecture.
- the memory definition describes the physical memory available in the system.
- the section layout definition describes how to locate sections in memory.

With this option you specify a linker script file via the control program to the linker. If you do not specify this option, the linker uses a default script file (`default.lsl`). You can specify the existing file `target.lsl` or the name of a manually written linker script file. You can use this option multiple times. The linker processes the LSL files in the order in which they appear on the command line.

Related information

[Section 7.7, Controlling the Linker with a Script](#)

Control program option: **--make-target**

Menu entry

-

Command line syntax

--make-target=*name*

Description

With this option you can overrule the default target name in the make dependencies generated by the options **--preprocess=+make** (**-Em**) and **--dep-file**. The default target name is the basename of the input file, with extension `.obj`.

Example

```
ccarm --preprocess=+make --make-target=./mytarget.obj test.c
```

The compiler generates dependency lines with the default target name `./mytarget.obj` instead of `test.obj`.

Related information

Control program option **--preprocess=+make** (Generate dependencies for make)

Control program option **--dep-file** (Generate dependencies in a file)

Control program option: --mil-link / --mil-split

Menu entry

1. Select **C/C++ Compiler » Optimization**.
2. Enable the option **Build for application wide optimizations (MIL linking)**.
3. Select **Optimize less/Build faster** or **Optimize more/Build slower**.

Command line syntax

```
--mil-link
--mil-split[=file,...]
```

Description

With option **--mil-link** the C compiler links the optimized intermediate representation (MIL) of all input files and MIL libraries specified on the command line in the compiler. The result is one single module that is optimized another time.

Option **--mil-split** does the same as option **--mil-link**, but in addition, the resulting MIL representation is written to a file with the suffix `.mil` and the C compiler also splits the MIL representation and writes it to separate files with suffix `.ms`. One file is written for each input file or MIL library specified on the command line. The `.ms` files are only updated on a change.

With option **--mil-split** you can perform application-wide optimizations during the frontend phase by specifying all modules at once, and still invoke the backend phase one module at a time to reduce the total compilation time. Application wide code compaction is not possible in this case.

Optionally, you can specify another filename for the `.ms` file the C compiler generates. Without an argument, the basename of the C source file is used to create the `.ms` filename. Note that if you specify a filename, you have to specify one filename for every input file.

Note that with both options some extra strict type checking is done that can cause building to fail in a way that is unforeseen and difficult to understand. For example, when you use one of these options in combination with option **--uchar** you might get the following error:

```
carm E289: [ "..\..\..\strlen.c" 14/1] "strlen" redeclared with a different type
carm I802: ["installation-dir\include\string.h" 44/17]
           previous declaration of "strlen"
1 errors, 0 warnings
```

This is caused by the fact that the MIL library is built without **--uchar**. You can workaround this problem by rebuilding the MIL libraries.

Build for application wide optimizations (MIL linking) and Optimize less/Build faster

This option is standard MIL linking and splitting. Note that you can control the optimizations to be performed with the optimization settings.

Optimize more/Build slower

When you enable this option, the compiler's frontend does not split the MIL stream in separate modules, but feeds it directly to the compiler's backend, allowing the code compaction to be performed application wide.

Related information

Section 4.1, *Compilation Process*

C compiler option `--mil` / `--mil-split`

Control program option: `--mixed-arm-thumb`

Menu entry

1. Select **C/C++ Compiler » Code Generation**.
2. Enable the option **Use full assembler for mixed ARM and Thumb instructions**.

Command line syntax

`--mixed-arm-thumb`

Description

With this option the control program calls the mixed ARM and Thumb assembler (**asarm**).

When you do not use this option, option `--thumb` determines which target assembler is chosen. Without `--thumb`: the ARM instruction set only assembler (**asarma**). With `--thumb`: the Thumb instruction set only assembler (**asmarmt**).

See the description of `--thumb` for more information.

Note that when you specify the ARMv6-M, ARMv7-M or ARMv7-EM architecture profile with `--cpu`, this automatically selects the Thumb-2 instruction set.

Related information

Control program option `--thumb` (use Thumb instruction set)

Control program option: `--no-default-libraries`

Menu entry

1. Select **Linker » Libraries**.
2. Disable the option **Link default libraries**.

Command line syntax

`--no-default-libraries`

Description

By default the control program specifies the standard C libraries (C99) and run-time library to the linker. With this option you tell the control program not to specify the standard C libraries and run-time library to the linker.

In this case you must specify the libraries you want to link to the linker with the option `--library=library_name` or pass the libraries as files on the command line. The control program recognizes the option `--library (-l)` as an option for the linker and passes it as such.

Example

```
ccarm --no-default-libraries test.c
```

The control program does not specify any libraries to the linker. In normal cases this would result in unresolved externals.

To specify your own libraries (`ccarm.lib`) and avoid unresolved externals:

```
ccarm --no-default-libraries --library=ccarm test.c
```

Related information

Control program option `--library` (Link system library)

Section 7.3.1, *How the Linker Searches Libraries*

Control program option: `--no-double` (-F)

Menu entry

1. Select **C/C++ Compiler » Language**.
2. Enable the option **Treat 'double' as 'float'**.

Command line syntax

`--no-double`

`-F`

Description

With this option you tell the compiler to treat variables of the type `double` as `float`. Because the `float` type takes less space, execution speed increases and code size decreases, both at the cost of less precision.

The control program also tells the linker to link the single-precision C library.

This option is an alias for [Control program option `--fp-model=+float`](#).

Related information

[Control program option `--fp-model`](#)

Control program option: **--no-map-file**

Menu entry

1. Select **Linker » Map File**.
2. Disable the option **Generate map file**.

Command line syntax

--no-map-file

Description

By default the control program tells the linker to generate a linker map file.

A linker map file is a text file that shows how the linker has mapped the sections and symbols from the various object files (.obj) to the linked object file. A locate part shows the absolute position of each section. External symbols are listed per space with their absolute address, both sorted on symbol and sorted on address.

With this option you prevent the generation of a map file.

Related information

-

Control program option: `--no-warnings (-w)`

Menu entry

1. Select **C/C++ Compiler » Diagnostics**.

The Suppress C compiler warnings box shows the warnings that are currently suppressed.

2. To suppress a warning, click on the **Add** button in the **Suppress warnings** box.
3. Enter the numbers, separated by commas or as a range, of the warnings you want to suppress (for example 537, 538). Or you can use the **Add** button multiple times.
4. To suppress all warnings, enable the option **Suppress all warnings**.

Use the **Edit** and **Delete** button to change a warning number or to remove a number from the list.

Command line syntax

```
--no-warnings [=number[-number], ...]
```

```
-w [number[-number], ...]
```

Description

With this option you can suppresses all warning messages for the various tools or specific control program warning messages.

On the command line this option works as follows:

- If you do not specify this option, all warnings are reported.
- If you specify this option but without numbers, all warnings of all tools are suppressed.
- If you specify this option with a number or a range, only the specified control program warnings are suppressed. You can specify the option `--no-warnings=number` multiple times.

Example

To suppress all warnings for all tools, enter:

```
ccarm test.c --no-warnings
```

Related information

Control program option `--warnings-as-errors` (Treat warnings as errors)

Control program option: --option-file (-f)

Menu entry

-

Command line syntax

`--option-file=file,...`

`-f file,...`

Description

This option is primarily intended for command line use. Instead of typing all options on the command line, you can create an option file which contains all options and flags you want to specify. With this option you specify the option file to the control program.

Use an option file when the command line would exceed the limits of the operating system, or just to store options and save typing.

You can specify the option **--option-file** multiple times.

Format of an option file

- Multiple arguments on one line in the option file are allowed.
- To include whitespace in an argument, surround the argument with single or double quotes.
- If you want to use single quotes as part of the argument, surround the argument by double quotes and vice versa:

```
"This has a single quote ' embedded"
```

```
'This has a double quote " embedded'
```

```
'This has a double quote " and a single quote ''' embedded"
```

- When a text line reaches its length limit, use a \ to continue the line. Whitespace between quotes is preserved.

```
"This is a continuation \  
line"
```

```
-> "This is a continuation line"
```

- It is possible to nest command line files up to 25 levels.

Example

Suppose the file `myoptions` contains the following lines:

```
--debug-info  
--define=DEMO=1  
test.c
```

Specify the option file to the control program:

```
ccarm --option-file=myoptions
```

This is equivalent to the following command line:

```
ccarm --debug-info --define=DEMO=1 test.c
```

Related information

-

Control program option: **--output (-o)**

Menu entry

Eclipse always uses the project name as the basename for the output file.

Command line syntax

```
--output=file
```

```
-o file
```

Description

By default, the control program generates a file with the same basename as the first specified input file. With this option you specify another name for the resulting absolute object file.

The default output format is ELF/DWARF, but you can specify another output format with option **--format**.

Example

```
ccarm test.c prog.c
```

The control program generates an ELF/DWARF object file (default) with the name `test.abs`.

To generate the file `result.abs`:

```
ccarm --output=result.abs test.c prog.c
```

Related information

Control program option **--format** (Set linker output format)

Linker option **--output** (Output file)

Linker option **--chip-output** (Generate an output file for each chip)

Control program option: --pass (-W)

Menu entry

1. Select **C/C++ Compiler » Miscellaneous** or **Assembler » Miscellaneous** or **Linker » Miscellaneous**.
2. Add an option to the **Additional options** field.

*Be aware that the options in the option file are added to the options you have set in the other pages. Only in extraordinary cases you may want to use them in combination. The assembler options are preceded by **-Wa** and the linker options are preceded by **-Wl**. For the C/C++ options you have to do this manually.*

Command line syntax

<code>--pass-assembler=option</code>	<code>-Waoption</code>	Pass option directly to the assembler
<code>--pass-c=option</code>	<code>-Wcoption</code>	Pass option directly to the C compiler
<code>--pass-c++=option</code>	<code>-Wcploption</code>	Pass option directly to the C++ compiler
<code>--pass-linker=option</code>	<code>-Wloption</code>	Pass option directly to the linker

Description

With this option you tell the control program to call a tool with the specified option. The control program does not use or interpret the option itself, but specifies it directly to the tool which it calls.

Example

To pass the option **--verbose** directly to the linker, enter:

```
ccarm --pass-linker=--verbose test.c
```

Related information

-

Control program option: `--preprocess (-E) / --no-preprocessing-only`

Menu entry

1. Select **C/C++ Compiler » Preprocessing**.
2. Enable the option **Store preprocessor output in <file>.pre**.
3. (Optional) Enable the option **Keep comments in preprocessor output**.
4. (Optional) Enable the option **Keep #line info in preprocessor output**.

Command line syntax

`--preprocess [=flags]`

`-E[flags]`

`--no-preprocessing-only`

You can set the following flags:

+/-comments	c/C	keep comments
+/-includes	i/I	generate a list of included source files
+/-list	l/L	generate a list of macro definitions
+/-make	m/M	generate dependencies for make
+/-noline	p/P	strip #line source position information

Default: `-ECILMP`

Description

With this option you tell the compiler to preprocess the C source. The C compiler sends the preprocessed output to the file `name.pre` (where `name` is the name of the C source file to compile). Eclipse also compiles the C source.

On the command line, the control program stops after preprocessing. If you also want to compile the C source you can specify the option `--no-preprocessing-only`. In this case the control program calls the compiler twice, once with option `--preprocess` and once for a regular compilation.

With `--preprocess=+comments` you tell the preprocessor to keep the comments from the C source file in the preprocessed output.

With `--preprocess=+includes` the compiler will generate a list of all included source files. The preprocessor output is discarded.

With `--preprocess=+list` the compiler will generate a list of all macro definitions. The preprocessor output is discarded.

With **--preprocess=+make** the compiler will generate dependency lines that can be used in a Makefile. The information is written to a file with extension `.d`. The preprocessor output is discarded. The default target name is the basename of the input file, with the extension `.obj`. With the option **--make-target** you can specify a target name which overrules the default target name.

With **--preprocess=+noline** you tell the preprocessor to strip the `#line` source position information (lines starting with `#line`). These lines are normally processed by the assembler and not needed in the preprocessed output. When you leave these lines out, the output is easier to read.

Example

```
ccarm --preprocess=+comments,-make,-noline --no-preprocessing-only test.c
```

The compiler preprocesses the file `test.c` and sends the output to the file `test.pre`. Comments are included but no dependencies are generated and the line source position information is not stripped from the output file. Next, the control program calls the compiler, assembler and linker to create the final object file `test.abs`

Related information

Control program option **--dep-file** (Generate dependencies in a file)

Control program option **--make-target** (Specify target name for **-Em** output)

Control program option: `--processors`

Menu entry

1. From the **Window** menu, select **Preferences**.

The Preferences dialog appears.

2. Select **TASKING » ARM**.
3. Click the **Add** button to add additional processor definition files.

Command line syntax

`--processors=file`

Description

With this option you can specify an additional XML file with processor definitions.

The standard list of supported cores is defined in the file `processors.xml`. An additionally specified processor definition file defines for each processor its full name (for example, STM32F205RB), its ID (for example, `stm32f205rb`), the architecture name (for example, ARMv7M), the core settings (for example, `cortexm3`), the on-chip flash settings, the list of silicon bugs for that processor. Each processor also defines options to supply to the linker for preprocessing the LSL file for the applicable on-chip memory definitions (for example, `-D__FLASH_SIZE=128k`).

Vendor specific processor definition files are available within Eclipse (and can be updated by the Eclipse update feature) or can be downloaded as a vendor support archive from the TASKING website (www.tasking.com).

The control program reads the specified *file* after the file `processors.xml` in the product's `etc` directory. Additional XML files can override processor definitions made in XML files that are read before.

Multiple `--processors` options are allowed.

Eclipse generates a `--processors` option in the makefiles for each specified XML file.

Example

Specify an additional processor definition file (suppose `processors-new.xml` contains a new processor ARMNEW):

```
ccarm --processors=processors-new.xml --cpu=ARMNEW test.c
```

Related information

Control program option `--cpu` (Select architecture)

Control program option: `--profile (-p)`

Menu entry

1. Select **C/C++ Compiler » Debugging**.
2. Enable or disable **Static profiling**.
3. Enable or disable one or more of the following **Generate profiling information** options (dynamic profiling):
 - **for block counters** (not in combination with Call graph or Function timers)
 - **to build a call graph**
 - **for function counters**
 - **for function timers**
4. Optionally, when you selected function timers, enable option **Exclude time spent in interrupt functions**.

Note that the more detailed information you request, the larger the overhead in terms of execution time, code size and heap space needed. The option `--debug` does not affect profiling, execution time or code size.

Command line syntax

`--profile[=flag, ...]`

`-p[flags]`

Use the following option for a predefined set of flags:

<code>--profile=g</code>	<code>-pg</code>	Profiling with call graph and function timers. Alias for: <code>-pBCFStI</code>
--------------------------	------------------	--

You can set the following flags:

<code>+/-block</code>	<code>b/B</code>	block counters
<code>+/-callgraph</code>	<code>c/C</code>	call graph
<code>+/-function</code>	<code>f/F</code>	function counters
<code>+/-interrupt</code>	<code>i/I</code>	exclude interrupt time
<code>+/-static</code>	<code>s/S</code>	static profile generation
<code>+/-time</code>	<code>t/T</code>	function timers

Default: `-pBCFStI`

TASKING VX-toolset for ARM User Guide

Default (without flags): `-pBCfSTI`

Description

Profiling is the process of collecting statistical data about a running application. With these data you can analyze which functions are called, how often they are called and what their execution time is.

Several methods of profiling exist. One method is *code instrumentation* which adds code to your application that takes care of the profiling process when the application is executed. Another method is *static profiling*.

For an extensive description of profiling refer to [Chapter 13, Profiling](#).

You can obtain the following profiling data (see flags above):

Block counters (not in combination with Call graph or Function timers)

This will instrument the code to perform basic block counting. As the program runs, it counts the number of executions of each branch in an if statement, each iteration of a for loop, and so on. Note that though you can combine Block counters with Function counters, this has no effect because Function counters is only a subset of Block counters.

Call graph (not in combination with Block counters)

This will instrument the code to reconstruct the run-time call graph. As the program runs it associates the caller with the gathered profiling data.

Function counters

This will instrument the code to perform function call counting. This is a subset of the basic Block counters.

Function timers (not in combination with Block counters/Function counters)

This will instrument the code to measure the time spent in a function. This includes the time spent in all sub functions (callees). Also the time spent in interrupt functions is taken into account, unless you enable option **Exclude time spent in interrupt functions** (`-pti`).

Static profiling

With this option you do not need to run the application to get profiling results. The compiler generates profiling information at compile time, without adding extra code to your application.

Note that the more detailed information you request, the larger the overhead in terms of execution time, code size and heap space needed. The option **Generate symbolic debug information** (`--debug`) does not affect profiling, execution time or code size.

The control program automatically specifies the corresponding profiling libraries to the linker.

Example

To generate block count information for the module `test.c` during execution, compile as follows:

```
ccarm --profile=+block test.c
```

In this case the control program tells the linker to link the library `pbarm.lib`.

Related information

[Chapter 13, *Profiling*](#)

Control program option: `--show-c++-warnings`

Menu entry

-

Command line syntax

`--show-c++-warnings`

Description

The C++ compiler may generate a compiled C++ file (.i.c) that causes warnings during compilation or assembling. With this option you tell the control program to show these warnings. By default C++ warnings are suppressed.

Related information

-

Control program option: `--silicon-bug`

Menu entry

1. Expand **C/C++ Build** and select **Processor**.
2. From the **Processor selection** list, select a processor.

*The **CPU problem bypasses and checks** box shows the available workarounds/checks available for the selected processor.*

3. (Optional) Select **Show all CPU problem bypasses and checks**.
4. Click **Select All** or select one or more individual options.

Command line syntax

```
--silicon-bug[=bug, ...]
```

Description

With this option you specify for which hardware problems the compiler should generate workarounds. Please refer to [Chapter 19, CPU Problem Bypasses and Checks](#) for the numbers and descriptions. Silicon bug numbers are specified as a comma separated list. When you use this option without arguments, all silicon bug workarounds are enabled.

The control program passes the option to both the compiler and the assembler.

Example

To enable workarounds for problem 602117, enter:

```
ccarm --silicon-bug=602117 test.c
```

Related information

[Chapter 19, CPU Problem Bypasses and Checks](#)

Compiler option `--silicon-bug`

Assembler option `--silicon-bug`

Control program option: `--thumb`

Menu entry

1. Select **C/C++ Compiler » Code Generation**.
2. Enable the option **Use Thumb instruction set**.

Command line syntax

`--thumb`

Description

Generate code in Thumb mode or Thumb-2 mode, depending on the architecture. The Thumb instruction set is a subset of the ARM instruction set which is encoded using 16-bit instructions instead of 32-bit instructions. The Thumb-2 instruction set has 16-bit and 32-bit instructions.

Depending on this option and option `--mixed-arm-thumb` a target assembler is chosen. **asarm** is the full assembler with both ARM and Thumb instructions. **asarma** is the ARM instruction set only assembler. **asarmt** is the Thumb instruction set only assembler.

<code>--thumb</code>	<code>--mixed-arm-thumb</code>	Assembler
no	no	asarma
no	yes	asarm
yes	no	asarmt
yes	yes	asarm --thumb

Note that when you specify the ARMv6-M, ARMv7-M, or ARMv7E-M architecture with `--cpu`, this automatically selects the Thumb-2 instruction set.

Related information

Control program option `--mixed-arm-thumb` (use mixed ARM and Thumb assembler)

Control program option: `--uchar (-u)`

Menu entry

1. Select **C/C++ Compiler » Language**.
2. Enable the option **Treat 'char' variables as unsigned**.

Command line syntax

`--uchar`

`-u`

Description

By default `char` is the same as specifying `signed char`. With this option `char` is the same as `unsigned char`. This option is passed to both the C++ compiler and the C compiler.

Note that this option can cause conflicts when you use it in combination with MIL linking. With MIL linking some extra strict type checking is done that can cause building to fail in a way that is unforeseen and difficult to understand. For example, when you use option `--mil-link` in combination with option `--uchar` you might get the following error:

```
carm E289: [ "..\..\..\strlen.c" 14/1] "strlen" redeclared with a different type
carm I802: ["installation-dir\include\string.h" 44/17]
           previous declaration of "strlen"
1 errors, 0 warnings
```

This is caused by the fact that the MIL library is built without `--uchar`. You can workaroud this problem by rebuilding the MIL libraries.

Related information

Section 1.1, *Data Types*

Control program option: **--undefine (-U)**

Menu entry

1. Select **C/C++ Compiler » Preprocessing**

The Defined symbols box shows the symbols that are currently defined.

2. To remove a defined symbol, select the symbol in the **Defined symbols** box and click on the **Delete** button.

Command line syntax

--undefine=*macro_name*

-U*macro_name*

Description

With this option you can undefine an earlier defined macro as with `#undef`. This option is for example useful to undefine predefined macros.

The following predefined ISO C standard macros cannot be undefined:

<code>__FILE__</code>	current source filename
<code>__LINE__</code>	current source line number (int type)
<code>__TIME__</code>	hh:mm:ss
<code>__DATE__</code>	Mmm dd yyyy
<code>__STDC__</code>	level of ANSI standard

The control program passes the option **--undefine (-U)** to the compiler.

Example

To undefine the predefined macro `__TASKING__`:

```
ccarm --undefine=__TASKING__ test.c
```

Related information

Control program option **--define** (Define preprocessor macro)

Section 1.9, *Predefined Preprocessor Macros*

Control program option: `--verbose (-v)`

Menu entry

1. Select **Global Options**.
2. Enable the option **Verbose mode of control program**.

Command line syntax

`--verbose`

`-v`

Description

With this option you put the control program in verbose mode. The control program performs its tasks while it prints the steps it performs to `stdout`.

Related information

Control program option `--dry-run` (Verbose output and suppress execution)

Control program option: --version (-V)

Menu entry

-

Command line syntax

`--version`

`-V`

Description

Display version information. The control program ignores all other options or input files.

Related information

-

Control program option: `--warnings-as-errors`

Menu entry

1. Select **Global Options**.
2. Enable the option **Treat warnings as errors**.

Command line syntax

```
--warnings-as-errors [=number [-number] , ... ]
```

Description

If one of the tools encounters an error, it stops processing the file(s). With this option you tell the tools to treat warnings as errors or treat specific control program warning messages as errors:

- If you specify this option but without numbers, all warnings are treated as errors.
- If you specify this option with a number or a range, only the specified control program warnings are treated as an error. You can specify the option `--warnings-as-errors=number` multiple times.

Use one of the `--pass-tool` options to pass this option directly to a tool when a specific warning for that tool must be treated as an error. For example, use `--pass-c--warnings-as-errors=number` to treat a specific C compiler warning as an error.

Related information

Control program option `--no-warnings` (Suppress some or all warnings)

Control program option `--pass` (Pass option to tool)

11.7. Parallel Make Utility Options

When you build a project in Eclipse, Eclipse generates a makefile and uses the make utility **amk** to build all your files. However, you can also use the make utility directly from the command line to build your project.

The invocation syntax is:

```
amk [option...] [target...] [macro=def]
```

This section describes all options for the parallel make utility.

For detailed information about the parallel make utility and using makefiles see [Section 9.2, Make Utility amk](#).

Parallel make utility option: `--always-rebuild (-a)`

Command line syntax

```
--always-rebuild
```

```
-a
```

Description

Normally the make utility rebuilds only those files that are out of date. With this option you tell the make utility to rebuild *all* files, without checking whether they are out of date.

Example

```
amk -a
```

Rebuilds all your files, regardless of whether they are out of date or not.

Related information

-

Parallel make utility option: **--change-dir (-G)**

Command line syntax

`--change-dir=path`

`-G path`

Description

Normally you must call the make utility from the directory where your makefile and other files are stored.

With the option **-G** you can call the make utility from within another directory. The *path* is the path to the directory where your makefile and other files are stored and can be absolute or relative to your current directory.

The macro `SUBDIR` is defined with the value of *path*.

Example

Suppose your makefile and other files are stored in the directory `..\myfiles`. You can call the make utility, for example, as follows:

```
amk -G ..\myfiles
```

Related information

-

Parallel make utility option: --diag

Command line syntax

```
--diag=[format:]{all | msg[-msg], ...}
```

You can set the following output formats:

html	HTML output.
rtf	Rich Text Format.
text	ASCII text.

Default format: text

Description

With this option you can ask for an extended description of error messages in the format you choose. The output is directed to stdout (normally your screen) and in the format you specify. You can specify the following formats: **html**, **rtf** or **text** (default). To create a file with the descriptions, you must redirect the output.

With the suboption **all**, the descriptions of all error messages are given. If you want the description of one or more selected error messages, you can specify the error message numbers, separated by commas, or you can specify a range.

Example

To display an explanation of message number 169, enter:

```
amk --diag=451
```

This results in the following message and explanation:

```
E451: make stopped
```

```
An error has occurred while executing one of the commands
of the target, and -k option is not specified.
```

To write an explanation of all errors and warnings in HTML format to file `amkerrors.html`, use redirection and enter:

```
amk --diag=html:all > amkerrors.html
```

Related information

-

Parallel make utility option: `--dry-run (-n)`

Command line syntax

`--dry-run`

`-n`

Description

With this option you tell the make utility to perform a dry run. The make utility shows what it would do but does not actually perform these tasks.

This option is for example useful to quickly inspect what would happen if you call the make utility.

Example

```
amk -n
```

The make utility does not perform any tasks but displays what it would do if called without the option `-n`.

Related information

[Parallel make utility option `-s`](#) (Do not print commands before execution)

Parallel make utility option: --help (-? / -h)

Command line syntax

```
--help[=item]
```

```
-h[item]
```

```
-?
```

You can specify the following arguments:

- options** o Show extended option descriptions

Description

Displays an overview of all command line options. When you specify the argument **options** you can list detailed option descriptions.

Example

The following invocations all display a list of the available command line options:

```
amk -?  
amk -h  
amk --help
```

To see a detailed description of the available options, enter:

```
amk --help=options
```

Related information

-

Parallel make utility option: --jobs (-j) / --jobs-limit (-J)

Menu

1. From the **Project** menu, select **Properties for**
The Properties dialog appears.
2. In the left pane, select **C/C++ Build**.
In the right pane the C/C++ Build page appears.
3. On the Behavior tab, select **Enable parallel build**.
4. You can specify the number of parallel jobs, or you can use an optimal number of jobs. In the last case, **amk** will fork as many jobs in parallel as cores are available.

Command line syntax

```
--jobs[=number]  
-j[number]  
  
--jobs-limit[=number]  
-J[number]
```

Description

When these options you can limit the number of parallel jobs. The default is 1. Zero means no limit. When you omit the *number*, **amk** uses the number of cores detected.

Option **-J** is the same as **-j**, except that the number of parallel jobs is limited by the number of cores detected.

Example

```
amk -j3
```

Limit the number of parallel jobs to 3.

Related information

-

Parallel make utility option: --keep-going (-k)

Command line syntax

`--keep-going`

`-k`

Description

When during the make process the make utility encounters an error, it stops rebuilding your files.

With the option `-k`, the make utility only stops building the target that produced the error. All other targets defined in the makefile are built.

Example

```
amk -k
```

If the make utility encounters an error, it stops building the current target but proceeds with the other targets that are defined in the makefile.

Related information

-

Parallel make utility option: `--list-targets (-l)`

Command line syntax

`--list-targets`

`-l`

Description

With this option, the make utility lists all "primary" targets that are out of date.

Example

```
amk -l  
list of targets
```

Related information

-

Parallel make utility option: `--makefile (-f)`

Command line syntax

```
--makefile=my_makefile
```

```
-f my_makefile
```

Description

By default the make utility uses the file `makefile` to build your files.

With this option you tell the make utility to use the specified file instead of the file `makefile`. Multiple `-f` options act as if all the makefiles were concatenated in a left-to-right order.

If you use `'-'` instead of a makefile name it means that the information is read from `stdin`.

Example

```
amk -f mymake
```

The make utility uses the file `mymake` to build your files.

Related information

-

Parallel make utility option: **--no-warnings (-w)**

Command line syntax

--no-warnings[=*number*, ...]

-w[*number*, ...]

Description

With this option you can suppresses all warning messages or specific warning messages.

On the command line this option works as follows:

- If you do not specify this option, all warnings are reported.
- If you specify this option but without numbers, all warnings are suppressed.
- If you specify this option with a number, only the specified warning is suppressed. You can specify the option **--no-warnings=number** multiple times.

Example

To suppress warnings 751 and 756, enter:

```
amk --no-warnings=751,756
```

Related information

Parallel make utility option **--warnings-as-errors** (Treat warnings as errors)

Parallel make utility option: **--silent (-s)**

Command line syntax

--silent

-s

Description

With this option you tell the make utility to perform its tasks without printing the commands it executes. Error messages are normally printed.

Example

```
amk -s
```

The make utility rebuilds your files but does not print the commands it executes during the make process.

Related information

[Parallel make utility option -n](#) (Perform a dry run)

Parallel make utility option: --version (-V)

Command line syntax

`--version`

`-V`

Description

Display version information. The make utility ignores all other options or input files.

Related information

-

Parallel make utility option: **--warnings-as-errors**

Command line syntax

```
--warnings-as-errors[=number, ...]
```

Description

If the make utility encounters an error, it stops. When you use this option without arguments, you tell the make utility to treat all warnings as errors. This means that the exit status of the make utility will be non-zero after one or more warnings. As a consequence, the make utility now also stops after encountering a warning.

You can also limit this option to specific warnings by specifying a comma-separated list of warning numbers.

Related information

Parallel make utility option **--no-warnings** (Suppress some or all warnings)

11.8. Archiver Options

The archiver and library maintainer **ararm** is a tool to build library files and it offers the possibility to replace, extract and remove modules from an existing library.

The invocation syntax is:

```
ararm key_option [sub_option...] library [object_file]
```

This section describes all options for the archiver. Some suboptions can only be used in combination with certain key options. They are described together. Suboptions that can always be used are described separately.

For detailed information about the archiver, see [Section 9.4, Archiver](#).

Short and long option names

Options can have both short and long names. Short option names always begin with a single minus (-) character, long option names always begin with two minus (--) characters. You can abbreviate long option names as long as it forms a unique name. You can mix short and long option names on the command line.

Overview of the options of the archiver utility

The following archiver options are available:

Description	Option	Sub-option
Main functions (key options)		
Replace or add an object module	-r	-a -b -c -n -u -v
Extract an object module from the library	-x	-o -v
Delete object module from library	-d	-v
Move object module to another position	-m	-a -b -v
Print a table of contents of the library	-t	-s0 -s1
Print object module to standard output	-p	
Sub-options		
Append or move new modules after existing module <i>name</i>	-a name	
Append or move new modules before existing module <i>name</i>	-b name	
Suppress the message that is displayed when a new library is created	-c	
Create a new library from scratch	-n	
Preserve last-modified date from the library	-o	
Print symbols in library modules	-s{0 1}	
Replace only newer modules	-u	
Verbose	-v	

Description	Option	Sub-option
Miscellaneous		
Display options	-?	
Display description of one or more diagnostic messages	--diag	
Display version header	-V	
Read options from <i>file</i>	-f file	
Suppress warnings above level <i>n</i>	-wn	

Archiver option: **--delete (-d)**

Command line syntax

--delete [**--verbose**]

-d [**-v**]

Description

Delete the specified object modules from a library. With the suboption **--verbose (-v)** the archiver shows which files are removed.

--verbose **-v** Verbose: the archiver shows which files are removed.

Example

```
ararm --delete mylib.lib obj1.obj obj2.obj
```

The archiver deletes `obj1.obj` and `obj2.obj` from the library `mylib.lib`.

```
ararm -d -v mylib.lib obj1.obj obj2.obj
```

The archiver deletes `obj1.obj` and `obj2.obj` from the library `mylib.lib` and displays which files are removed.

Related information

-

Archiver option: `--diag`

Command line syntax

```
--diag=[format:]{all | msg[-msg], ...}
```

You can set the following output formats:

html	HTML output.
rtf	Rich Text Format.
text	ASCII text.

Default format: text

Description

With this option you can ask for an extended description of error messages in the format you choose. The output is directed to stdout (normally your screen) and in the format you specify. The archiver does not perform any actions. You can specify the following formats: **html**, **rtf** or **text** (default). To create a file with the descriptions, you must redirect the output.

With the suboption **all**, the descriptions of all error messages are given. If you want the description of one or more selected error messages, you can specify the error message numbers, separated by commas, or you can specify a range.

Example

To display an explanation of message number 102, enter:

```
ararm --diag=102
```

This results in the following message and explanation:

```
F102: cannot create "<file>"
```

The output file or a temporary file could not be created. Check if you have sufficient disk space and if you have write permissions for the specified file.

To write an explanation of all errors and warnings in HTML format to file `arerrors.html`, use redirection and enter:

```
ararm --diag=html:all > arerrors.html
```

Related information

-

Archiver option: `--dump (-p)`

Command line syntax

`--dump`

`-p`

Description

Print the specified object module(s) in the library to standard output.

This option is only useful when you redirect or pipe the output to other files or tools that serve your own purposes. Normally you do not need this option.

Example

```
ararm --dump mylib.lib obj1.obj > file.obj
```

The archiver prints the file `obj1.obj` to standard output where it is redirected to the file `file.obj`. The effect of this example is very similar to extracting a file from the library but in this case the 'extracted' file gets another name.

Related information

-

Archiver option: **--extract (-x)**

Command line syntax

```
--extract [--modtime] [--verbose]
```

```
-x [-o] [-v]
```

Description

Extract an existing module from the library.

--modtime	-o	Give the extracted object module the same date as the last-modified date that was recorded in the library. Without this suboption it receives the last-modified date of the moment it is extracted.
--verbose	-v	Verbose: the archiver shows which files are extracted.

Example

To extract the file `obj1.obj` from the library `mylib.lib`:

```
ararm --extract mylib.lib obj1.obj
```

If you do not specify an object module, all object modules are extracted:

```
ararm -x mylib.lib
```

Related information

-

Archiver option: --help (-?)

Command line syntax

`--help[=item]`

`-?`

You can specify the following argument:

options	Show extended option descriptions
----------------	-----------------------------------

Description

Displays an overview of all command line options. When you specify the argument **options** you can list detailed option descriptions.

Example

The following invocations all display a list of the available command line options:

```
ararm -?  
ararm --help  
ararm
```

To see a detailed description of the available options, enter:

```
ararm --help=options
```

Related information

-

Archiver option: **--move (-m)**

Command line syntax

```
--move [-a posname] [-b posname]
```

```
-m [-a posname] [-b posname]
```

Description

Move the specified object modules to another position in the library.

The ordering of members in a library can make a difference in how programs are linked if a symbol is defined in more than one member.

By default, the specified members are moved to the end of the archive. Use the suboptions **-a** or **-b** to move them to a specified place instead.

--after=<i>posname</i>	-a	Move the specified object module(s) after the existing module <i>posname</i> .
--before=<i>posname</i>	-b	Move the specified object module(s) before the existing module <i>posname</i> .

Example

Suppose the library `mylib.lib` contains the following objects (see option **--print**):

```
obj1.obj
obj2.obj
obj3.obj
```

To move `obj1.obj` to the end of `mylib.lib`:

```
ararm --move mylib.lib obj1.obj
```

To move `obj3.obj` just before `obj2.obj`:

```
ararm -m -b obj3.obj mylib.lib obj2.obj
```

The library `mylib.lib` after these two invocations now looks like:

```
obj3.obj
obj2.obj
obj1.obj
```

Related information

Archiver option **--print (-t)** (Print library contents)

Archiver option: **--option-file (-f)**

Command line syntax

--option-file=*file*

-f *file*

Description

Instead of typing all options on the command line, you can create an option file which contains all options and flags you want to specify. With this option you specify the option file to the archiver.

Use an option file when the command line would exceed the limits of the operating system, or just to store options and save typing.

You can specify the option **--option-file (-f)** multiple times.

If you use '-' instead of a filename it means that the options are read from `stdin`.

Format of an option file

- Multiple arguments on one line in the option file are allowed.
- To include whitespace in an argument, surround the argument with single or double quotes.
- If you want to use single quotes as part of the argument, surround the argument by double quotes and vice versa:

```
"This has a single quote ' embedded"
```

```
'This has a double quote " embedded'
```

```
'This has a double quote " and a single quote ''' embedded"
```

- When a text line reaches its length limit, use a `\` to continue the line. Whitespace between quotes is preserved.

```
"This is a continuation \  
line"
```

```
-> "This is a continuation line"
```

- It is possible to nest command line files up to 25 levels.

Example

Suppose the file `myoptions` contains the following lines:

```
-x mylib.lib obj1.obj  
-w5
```

Specify the option file to the archiver:

```
ararm --option-file=myoptions
```

This is equivalent to the following command line:

```
ararm -x mylib.lib obj1.obj -w5
```

Related information

-

Archiver option: --print (-t)

Command line syntax

```
--print [--symbols=0|1]
```

```
-t [-s0|-s1]
```

Description

Print a table of contents of the library to standard output. With the suboption **-s0** the archiver displays all symbols per object file.

--symbols=0	-s0	Displays per object the name of the object itself and all symbols in the object.
--symbols=1	-s1	Displays the symbols of all object files in the library in the form <i>library_name:object_name:symbol_name</i>

Example

```
ararm --print mylib.lib
```

The archiver prints a list of all object modules in the library `mylib.lib`:

```
ararm -t -s0 mylib.lib
```

The archiver prints per object all symbols in the library. For example:

```
cstart.obj
  symbols:
    Reset_Handler
```

Related information

-

Archiver option: **--replace (-r)**

Command line syntax

```
--replace [--after=posname] [--before=posname]
           [--create] [--new] [--newer-only] [--verbose]
```

```
-r [-a posname] [-b posname][-c] [-n] [-u] [-v]
```

Description

You can use the option **--replace (-r)** for several purposes:

- Adding new objects to the library
- Replacing objects in the library with the same object of a newer date
- Creating a new library

The option **--replace (-r)** normally *adds* a new module to the library. However, if the library already contains a module with the specified name, the existing module is *replaced*. If you specify a library that does not exist, the archiver creates a new library with the specified name.

If you add a module to the library without specifying the suboption **-a** or **-b**, the specified module is added at the end of the archive. Use the suboptions **-a** or **-b** to insert them after/before a specified place instead.

--after=<i>posname</i>	-a <i>posname</i>	Insert the specified object module(s) after the existing module <i>posname</i> .
--before=<i>posname</i>	-b <i>posname</i>	Insert the specified object module(s) before the existing module <i>posname</i> .
--create	-c	Suppress the message that is displayed when a new library is created.
--new	-n	Create a new library from scratch. If the library already exists, it is overwritten.
--newer-only	-u	Insert the specified object module only if it is newer than the module in the library.
--verbose	-v	Verbose: the archiver shows which files are replaced.

The suboptions **-a** or **-b** have no effect when an object is added to the library.

Example

Suppose the library `mylib.lib` contains the following object (see option **--print**):

```
obj1.obj
```

To add `obj2.obj` to the end of `mylib.lib`:

```
ararm --replace mylib.lib obj2.obj
```

TASKING VX-toolset for ARM User Guide

To insert `obj3.obj` just before `obj2.obj`:

```
ararm -r -b obj2.obj mylib.lib obj3.obj
```

The library `mylib.lib` after these two invocations now looks like:

```
obj1.obj  
obj3.obj  
obj2.obj
```

Creating a new library

To *create a new library file*, add an object file and specify a library that does not yet exist:

```
ararm --replace newlib.lib obj1.obj
```

The archiver creates the library `newlib.lib` and adds the object `obj1.obj` to it.

To *create a new library file and overwrite an existing library*, add an object file and specify an existing library with the supoption **--new (-n)**:

```
ararm -r -n mylib.lib obj1.obj
```

The archiver overwrites the library `mylib.lib` and adds the object `obj1.obj` to it. The new library `mylib.lib` only contains `obj1.obj`.

Related information

Archiver option **--print (-t)** (Print library contents)

Archiver option: --version (-V)

Command line syntax

`--version`

`-v`

Description

Display version information. The archiver ignores all other options or input files.

Related information

-

Archiver option: **--warning (-w)**

Command line syntax

`--warning=level`

`-wlevel`

Description

With this suboption you tell the archiver to suppress all warnings above the specified level. The level is a number between 0 - 9.

The level of a message is printed between parentheses after the warning number. If you do not use the `-w` option, the default warning level is 8.

Example

To suppress warnings above level 5:

```
ararm --extract --warning=5 mylib.lib obj1.obj
```

Related information

-

11.9. HLL Object Dumper Options

The high level language (HLL) dumper **hldumparm** is a program to dump information about an absolute object file (`.abs`).

Short and long option names

Options can have both short and long names. Short option names always begin with a single minus (-) character, long option names always begin with two minus (--) characters. You can abbreviate long option names as long as it forms a unique name. You can mix short and long option names on the command line.

Options can have flags or suboptions. To switch a flag 'on', use a lowercase letter or a *+longflag*. To switch a flag off, use an uppercase letter or a *-longflag*. Separate *longflags* with commas. The following two invocations are equivalent:

```
hldumparm -FdhMsy test.abs
hldumparm --dump-format=+dump,+hllsymbols,-modules,+sections,+symbols test.abs
```

When you do not specify an option, a default value may become active.

HLL object dumper option: **--class (-c)**

Command line syntax

`--class[=class]`

`-c[class]`

You can specify one of the following classes:

all	a	Dump contents of all sections.
code	c	Dump contents of code sections.
data	d	Dump contents of data sections.

Default: `--class=all`

Description

With this option you can restrict the output to code or data only. This option affects all parts of the output, except the module list. The effect is listed in the following table.

Output part	Effect of <code>--class</code>
Module list	Not restricted
Section list	Only lists sections of the specified class
Section dump	Only dumps the contents of the sections of the specified class
HLL symbol table	Only lists symbols of the specified class
Assembly level symbol table	Only lists symbols defined in sections of the specified class
Note sections	Not restricted

By default all sections are included.

Related information

[Section 9.5.2, HLL Dump Output Format](#)

HLL object dumper option: --copy-table

Command line syntax

`--copy-table`

Description

With this option the HLL object dumper attempts to translate the specified code address to the destination address of a copy table copy command during disassembly.

Related information

-

HLL object dumper option: --diag

Command line syntax

```
--diag=[format:]{all | msg[-msg],...}
```

You can set the following output formats:

html	HTML output.
rtf	Rich Text Format.
text	ASCII text.

Default format: text

Description

With this option you can ask for an extended description of error messages in the format you choose. The output is directed to stdout (normally your screen) and in the format you specify. The HLL object dumper does not process any files. You can specify the following formats: **html**, **rtf** or **text** (default). To create a file with the descriptions, you must redirect the output.

With the suboption **all**, the descriptions of all error messages are given. If you want the description of one or more selected error messages, you can specify the error message numbers, separated by commas, or you can specify a range.

Example

To display an explanation of message number 101, enter:

```
hldumparm --diag=101
```

This results in the following message and explanation:

```
F101: cannot create "<file>"
```

```
The output file or a temporary file could not be created.  
Check if you have sufficient disk space and if you have  
write permissions for the specified file.
```

To write an explanation of all errors and warnings in HTML format to file `hldumperrors.html`, use redirection and enter:

```
hldumparm --diag=html:all > hldumperrors.html
```

Related information

-

HLL object dumper option: **--disassembly-intermix (-i)**

Command line syntax

`--disassembly-intermix[=flag]`

`-i[flag]`

You can specify the following format flags:

+/-single-line **s/S** Force the insert to be limited to the first preceding source line.

Default: `--disassembly-intermix=S`

Description

With this option the disassembly is intermixed with HLL source code. The source is searched for as described with option **--source-lookup-path**

The **+single-line** sub-option forces the insert to be limited to the first preceding source line. With the **-single-line** sub-option all source lines that belong to the address are prefixed. For example comments are thus also visible. This is the default.

Example

```
hldumparm --disassembly-intermix --source-lookup-path=c:\mylib\src hello.abs
```

Related information

HLL object dumper option **--source-lookup-path**

HLL object dumper option: `--disassembly-without-encoding (-r)`

Command line syntax

`--disassembly-without-encoding`

`-r`

Description

With this option the address and encoding are not part of the disassembly of a code section. This is useful when you only want the disassembly part.

Example

```
hldumparm -F2 hello.elf
```

```
----- Section dump -----
```

```
                                .section .text, at(0x00000690)
00000690 08 00 9f e5 main          ldr    r0, [r15, #+0x8]
00000694 00 10 90 e5              ldr    r1, [r0, #+0x0]
00000698 04 00 9f e5              ldr    r0, [r15, #+0x4]
0000069c 74 ff ff ea              b      printf
000006a0 80 01                    .dh 0180
000006a2 04 00                    .dh 0004
000006a4 a8 06                    .dh 06a8
000006a6 00 00                    .dh 0000
                                .endsec
```

```
hldumparm -F2 --disassembly-without-encoding hello.elf
```

```
----- Section dump -----
```

```
                                .section .text, at(0x00000690)
main:          ldr    r0, [r15, #+0x8]
              ldr    r1, [r0, #+0x0]
              ldr    r0, [r15, #+0x4]
              b      printf
              .dh 0180
              .dh 0004
              .dh 06a8
              .dh 0000
              .endsec
```

Related information

-

HLL object dumper option: `--dump-format (-F)`

Command line syntax

`--dump-format [=flag, ...]`

`-F[flag]...`

You can specify the following format flags:

+/-dump	d/D	Dump the contents of the sections in the object file. Code sections can be disassembled, data sections are dumped.
+/-hllsymbols	h/H	List the high level language symbols, with address, size and type.
+/-modules	m/M	Print a list of modules found in object file.
+/-note	n/N	Dump all ELF <code>.note</code> sections.
+/-sections	s/S	Print a list of sections with start address, length and type.
+/-symbols	y/Y	List the low level symbols, with address and length (if known).
	0	Alias for DHMNSY (nothing)
	1	Alias for DhMNSY (only HLL symbols)
	2	Alias for dHMNSY (only section contents)
	3	Alias for dhmnsy (default, everything)

Default: `--dump-format=dhmnsy`

Description

With this option you can control which parts of the dump output you want to see. By default, all parts are dumped.

1. Module list
2. Section list
3. Section dump (disassembly)
4. HLL symbol table
5. Assembly level symbol table
6. Note sections

You can limit the number of sections that will be dumped with the options `--sections` and `--section-types`.

Related information

Section 9.5.2, *HLL Dump Output Format*

HLL object dumper option: **--expand-symbols (-e)**

Command line syntax

```
--expand-symbols[=flag],...
```

```
-e[flag]...
```

You can specify one of the following flags:

+/-basic-types	b/B	Expand arrays with basic C types.
+/-fullpath	f/F	Include the full path to the field level.
+/-gap-info	g/G	Insert gap markers where data is not consecutive.
+/-nesting-indicator	n/N	Print nesting bars.

Default (no flags): `--expand-symbols=BFGN`

Description

With this option you specify that all struct, union and array symbols are expanded with their fields in the HLL symbol dump.

With `--expand-symbols=+basic-types`, HLL struct and union symbols are listed including all fields. Array members are expanded in one array member per line regardless of the HLL type. For the fields the types and names are indented with 2 spaces.

With `--expand-symbols=+fullpath`, all fields of structs and unions and all members of non-basic type arrays are expanded and prefixed with their parent's names.

With `--expand-symbols=+gap-info`, unused memory in complex data types (structures and unions) between data objects and between code objects is shown as `{gap}` parts. This option is useful to optimize data memory usage. This option only works if debug information is available in the ELF file.

With `--expand-symbols=+nesting-indicator`, vertical bars (|) are shown to make it easier to see the expanded structs, unions and arrays.

Example

```
hldumparm -F1 hello.abs
```

```
----- HLL symbol table -----
```

```
00040000      24 struct          _dbg_request [dbg.c]
00040018      80 static char      stdin_buf[80] [_iob.c]
```

```
hldumparm -e -F1 hello.abs
```

```
----- HLL symbol table -----
```

```
00040000      24 struct          _dbg_request [dbg.c]
```

```

00040000      4  int                _errno
00040004      4  enum                nr
00040008     16  union                u
00040008      4  struct                exit
00040008      4  int                status
00040008      8  struct                open
00040008      4  const char            * pathname
0004000c      2  unsigned short int    flags
...
00040018     80  static char            stdin_buf[80] [_iob.c]

```

```
hldumparm -eb -F1 hello.abs
```

```
----- HLL symbol table -----
```

```

00040000     24  struct                _dbg_request [dbg.c]
00040000      4  int                _errno
00040004      4  enum                nr
00040008     16  union                u
00040008      4  struct                exit
00040008      4  int                status
00040008      8  struct                open
00040008      4  const char            * pathname
0004000c      2  unsigned short int    flags
...
00040018     80  static char            stdin_buf[80] [_iob.c]
00040018      1  char
00040019      1  char
0004001a      1  char
...
00040067      1  char

```

```
hldumparm -ef -F1 hello.abs
```

```
----- HLL symbol table -----
```

```

00040028     24  struct                _dbg_request [dbg.c]
00040028      4  int                _dbg_request._errno
0004002c      4  enum                _dbg_request.nr
00040030     16  union                _dbg_request.u
00040030      4  struct                _dbg_request.u.exit
00040030      4  int                _dbg_request.u.exit.status
00040030      8  struct                _dbg_request.u.open
00040030      4  const char            * _dbg_request.u.open.pathname
00040034      2  unsigned short int    _dbg_request.u.open.flags
...
00040018     80  static char            stdin_buf[80] [_iob.c]

```

TASKING VX-toolset for ARM User Guide

```
hldumparm -eg -F1 hello.abs
```

```
----- HLL symbol table -----
```

```
00040000    24 struct          _dbg_request [dbg.c]
00040000     4  int           _errno
00040004     4  enum           nr
00040008    16  union           u
00040008     4    struct          exit
00040008     4    int           status
0004000c    12    {gap}
00040008     8    struct          open
00040008     4    const char      * pathname
0004000c     2    unsigned short int  flags
0004000e     2    {gap}
00040010     8    {gap}
    ...
00040018    80 static char      stdin_buf[80] [_iob.c]
```

```
hldumparm -en -F1 hello.abs
```

```
----- HLL symbol table -----
```

```
00040000    24 struct          _dbg_request [dbg.c]
00040000     4 | int           _errno
00040004     4 | enum           nr
00040008    16 | union           u
00040008     4 | | struct          exit
00040008     4 | | | int           status
00040008     8 | | struct          open
00040008     4 | | | const char      * pathname
0004000c     2 | | | unsigned short int  flags
    ...
00040018    80 static char      stdin_buf[80] [_iob.c]
```

Related information

[Section 9.5.2, HLL Dump Output Format](#)

HLL object dumper option: --help (-?)

Command line syntax

`--help`

`-?`

Description

Displays an overview of all command line options.

Example

The following invocations all display a list of the available command line options:

```
hldumparm -?  
hldumparm --help  
hldumparm
```

Related information

-

HLL object dumper option: --hex (-x)

Command line syntax

--hex

-x

Description

With this option you can control the way data sections and code sections are dumped. By default, the contents of data sections are represented by directives. A new directive will be generated for each symbol. ELF labels in the section are used to determine the start of a directive. ROM sections are represented with `.db`, `.dh`, `.dw`, `.dd` kind of directives, depending on the size of the data. RAM sections are represented with `.ds` directives, with a size operand depending on the data size. This can be either the size specified in the ELF symbol, or the size up to the next label. Code sections are dumped as disassembly.

With option `--hex`, no directives will be generated for ROM data sections and no disassembly dump will be done for code sections. Instead ROM data sections and code sections are dumped as hexadecimal code with ASCII translation. RAM sections will be represented with only a start address and a size indicator.

Example

```
hldumparm -F2 --section=.rodata hello.abs
```

```
----- Section dump -----
```

```
.section .data, '.rodata', at(0x000006a8)
.db 48,65,6c,6c,6f,20,25,73,21,0a,00           ; Hello %s!..
.endsec

.section .data, '.rodata', at(0x000006b4)
.db 77,6f,72,6c,64,00                         ; world.
.endsec
```

```
hldumparm -F2 --section=.rodata --hex hello.abs
```

```
----- Section dump -----
```

```
                section 7 (.rodata):
000006a8 48 65 6c 6c 6f 20 25 73 21 0a 00           Hello %s!..

                section 5 (.rodata):
000006b4 77 6f 72 6c 64 00                         world.
```

Related information

[Section 9.5.2, HLL Dump Output Format](#)

HLL object dumper option: `--option-file (-f)`

Command line syntax

```
--option-file=file,...
```

```
-f file,...
```

Description

This option is primarily intended for command line use. Instead of typing all options on the command line, you can create an option file which contains all options and flags you want to specify. With this option you specify the option file to the HLL object dumper.

Use an option file when the command line would exceed the limits of the operating system, or just to store options and save typing.

You can specify the option `--option-file` multiple times.

Format of an option file

- Multiple arguments on one line in the option file are allowed.
- To include whitespace in an argument, surround the argument with single or double quotes.
- If you want to use single quotes as part of the argument, surround the argument by double quotes and vice versa:

```
"This has a single quote ' embedded"
```

```
'This has a double quote " embedded'
```

```
'This has a double quote " and a single quote ''' embedded"
```

- When a text line reaches its length limit, use a `\` to continue the line. Whitespace between quotes is preserved.

```
"This is a continuation \  
line"
```

```
-> "This is a continuation line"
```

- It is possible to nest command line files up to 25 levels.

Example

Suppose the file `myoptions` contains the following lines:

```
--symbols=hll  
--class=code  
hello.abs
```

TASKING VX-toolset for ARM User Guide

Specify the option file to the HLL object dumper:

```
hldumparm --option-file=myoptions
```

This is equivalent to the following command line:

```
hldumparm --symbols=hll --class=code hello.abs
```

Related information

-

HLL object dumper option: `--output (-o)`

Command line syntax

```
--output=file
```

```
-o file
```

Description

By default, the HLL object dumper dumps the output on `stdout`. With this option you specify to dump the information in the specified file.

The default output format is text, but you can specify another output format with option `--output-type`.

Example

```
hldumparm --output=dump.txt hello.abs
```

The HLL object dumper dumps the output in file `dump.txt`.

Related information

HLL object dumper option `--output-type`

HLL object dumper option: `--output-type (-T)`

Command line syntax

`--output-type [=type]`

`-T [type]`

You can specify one of the following types:

text	t	Output human readable text.
xml	x	Output XML.

Default: `--output-type=text`

Description

With this option you can specify whether the output is formatted as plain text or as XML.

Related information

HLL object dumper option `--output`

HLL object dumper option: `--print-mangled-symbols (-P)`

Command line syntax

```
--print-mangled-symbols
```

```
-P
```

Description

The C++ compiler can generate unreadable symbol names. These symbols cannot easily be related to your C++ source file anymore. Therefore the HLL dumper by default demangles C++ function names and variable names in the HLL symbol table. With this option you can override this default setting and print the mangled names instead.

Example

```
hldumparm hellocpp.abs
```

```
----- HLL symbol table -----
```

Address	Size	HLL Type	Name
00001254	20	void	<code>__register_finalization_routine()</code>

```
hldumparm --print-mangled-symbols hellocpp.abs
```

```
----- HLL symbol table -----
```

Address	Size	HLL Type	Name
00001254	20	void	<code>__Z31__register_finalization_routinev()</code>

Related information

```
-
```

HLL object dumper option: --sections (-s)

Command line syntax

`--sections=name,...`

`-sname,...`

Description

With this option you can restrict the output to the specified sections only. This option affects the following parts of the output:

Output part	Effect of --sections
Module list	Not restricted
Section list	Only lists the specified sections
Section dump	Only dumps the contents of the specified sections
HLL symbol table	Not restricted
Assembly level symbol table	Only lists symbols defined in the specified sections
Note sections	Not restricted

By default all sections are included.

Related information

[Section 9.5.2, HLL Dump Output Format](#)

HLL object dumper option: **--source-lookup-path (-L)**

Command line syntax

--source-lookup-path=*path*

-L*path*

Description

With this option you can specify an additional path where your source files are located. If you want to specify multiple paths, use the option **--source-lookup-path** for each separate path.

The order in which the HLL object dumper will search for source files when intermixed disassembly is used, is:

1. The path obtained from the HLL debug information.
2. The path that is specified with the option **--source-lookup-path**. If multiple paths are specified, the paths will be searched for in the order in which they are given on the command line.

Example

Suppose you call the HLL object dumper as follows:

```
hldumparm --disassembly-intermix --source-lookup-path=c:\mylib\src hello.abs
```

First the HLL object dumper looks in the directory found in the HLL debug information of file `hello.abs` for the location of the source file(s). If it does not find the file(s), it looks in the directory `c:\mylib\src`.

Related information

HLL object dumper option **--disassembly-intermix**

HLL object dumper option: --symbols (-S)

Command line syntax

`--symbols[=type]`

`-s[type]`

You can specify one of the following types:

asm	a	Display assembly symbols in code dump.
hll	h	Display HLL symbols in code dump.
none	n	Display plain addresses in code dump.

Default: `--symbols=asm`

Description

With this option you can control symbolic information in the disassembly and data dump. For data sections this only applies to symbols used as labels at the data addresses. Data within the data sections will never be replaced with symbols.

Only symbols that are available in the ELF or DWARF information are used. If you build an application without HLL debug information the `--symbols=hll` option will result in the same output as with `--symbols=none`. The same applies to the `--symbols=asm` option when all symbols are stripped from the ELF file.

Example

```
hldumparm -F2 hello.abs
```

```
----- Section dump -----
```

```
00000000 e2 00 00 ea          .section .text, '_vector_0'
                                b          Reset_Handler
                                .endsec
```

```
hldumparm --symbols=none -F2 hello.abs
```

```
----- Section dump -----
```

```
00000000 e2 00 00 ea          .section .text, '_vector_0'
                                b          0x390
                                .endsec
```

Related information

[Section 9.5.2, HLL Dump Output Format](#)

HLL object dumper option: --version (-V)

Command line syntax

`--version`

`-v`

Description

Display version information. The HLL object dumper ignores all other options or input files.

Related information

-

HLL object dumper option: `--xml-base-filename (-X)`

Command line syntax

`--xml-base-filename`

`-X`

Description

With this option the `<File name>` field in the XML output only contains the filename of the object file. By default, any path name, if present, is printed as well.

Example

```
hldumparm --output-type=xml --output=hello.xml ../hello.abs
```

The field `<File name=" ../hello.abs">` is used in `hello.xml`.

```
hldumparm --output-type=xml --output=hello.xml -X ../hello.abs
```

The field `<File name="hello.abs">` is used in `hello.xml`. The path is stripped from the filename.

Related information

HLL object dumper option `--output-type`

11.10. Expire Cache Utility Options

With the utility **expirearm** you can limit the size of the cache (C compiler [option --cache](#)) by removing all files older than a few days or by removing older files until the total size of the cache is smaller than a specified size. See also [Section 12.5, *Compiler Cache*](#).

The invocation syntax is:

```
expirearm [option]... cache-directory
```

The compiler cache is present in the directory `carcache` under the specified *cache-directory*.

This section describes all options for the expire cache utility.

Short and long option names

Options can have both short and long names. Short option names always begin with a single minus (-) character, long option names always begin with two minus (--) characters. You can abbreviate long option names as long as it forms a unique name. You can mix short and long option names on the command line.

Expire cache utility option: **--access (-a)**

Command line syntax

--access

-a

Description

Use the last access time instead of the last modification time to determine which files to delete.

Example

```
expirearm --access --days=7 "installation-dir\mproject\.cache"
```

Related information

-

Expire cache utility option: `--days (-d)`

Menu entry

1. Select **C/C++ Compiler » Optimization » Compilation Speed**.
2. Enable the option **Cache generated code to improve the compilation speed**.
3. In the **Directory for cached files** field, enter the name for the location of the cache.
By default this is the `.cache` directory under your project directory.
4. Specify the **Maximum days files will live in the cache**.

Command line syntax

`--days=n`

`-dn`

Description

Remove all files older than *n* days from the cache.

Example

To remove all files older than seven days, enter:

```
expirearm --days=7 "installation-dir\mproject\.cache"
```

Related information

-

Expire cache utility option: **--diag**

Command line syntax

```
--diag=[format:]{all | msg[-msg],...}
```

You can set the following output formats:

html	HTML output.
rtf	Rich Text Format.
text	ASCII text.

Default format: text

Description

With this option you can ask for an extended description of error messages in the format you choose. The output is directed to stdout (normally your screen) and in the format you specify. You can specify the following formats: **html**, **rtf** or **text** (default). To create a file with the descriptions, you must redirect the output.

With the suboption **all**, the descriptions of all error messages are given. If you want the description of one or more selected error messages, you can specify the error message numbers, separated by commas, or you can specify a range.

With this option the expire cache utility does not remove any files.

Example

To display an explanation of message number 204, enter:

```
expirearm --diag=204
```

This results in the following message and explanation:

```
E204: failed to remove "<file>" <<cause>>
```

The removal of the indicated file failed. The *<cause>* provides more details of the problem.

To write an explanation of all errors and warnings in HTML format to file `expirearm_errors.html`, use redirection and enter:

```
expirearm --diag=html:all > expirearm_errors.html
```

Related information

-

Expire cache utility option: `--dry-run (-n)`

Command line syntax

`--dry-run`

`-n`

Description

With this option you put the expire utility in verbose mode. The utility shows which files would be deleted, without actually removing them.

Related information

Expire cache utility option `--verbose` (Verbose output)

Expire cache utility option: --help (-?)

Command line syntax

```
--help[=item]
```

```
-?
```

You can specify the following argument:

options	Show extended option descriptions
----------------	-----------------------------------

Description

Displays an overview of all command line options. When you specify the argument **options** you can list detailed option descriptions.

Example

The following invocations all display a list of the available command line options:

```
expirearm -?  
expirearm --help  
expirearm
```

To see a detailed description of the available options, enter:

```
expirearm --help=options
```

Related information

-

Expire cache utility option: --megabytes (-m)

Menu entry

1. Select **C/C++ Compiler » Optimization » Compilation Speed**.
2. Enable the option **Cache generated code to improve the compilation speed**.
3. In the **Directory for cached files** field, enter the name for the location of the cache.

By default this is the .cache directory under your project directory.

4. Enable the option **Clear cache upon project clean**.

*Each time you use **Project » Clean...** the cache is cleared.*

Command line syntax

`--megabytes=m`

`-mm`

Description

Reduce the size of the cache to *m* MBytes by removing files from the cache, starting with the oldest file. With a size of 0 (zero) you clear the entire cache.

Example

To reduce the compiler cache size to 4 MB, enter:

```
expirearm --megabytes=4 "installation-dir\mproject\.cache"
```

Older files are removed until the total size of the cache is smaller than 4 MB.

To clear the compiler cache, enter:

```
expirearm --megabytes=0 "installation-dir\mproject\.cache"
```

Related information

-

Expire cache utility option: **--totals (-t)**

Command line syntax

`--totals`

`-t`

Description

Show the total size of the cache and the number of directories and files. This option is implicit when invoked without the **--days** and **--megabytes** options.

Example

```
expirearm -t "installation-dir\mproject\.cache"
```

```
installation-dir\mproject\.cache\carmcache:  
1 MB, 3 directories, 3 files
```

Related information

-

Expire cache utility option: --verbose (-v)

Command line syntax

--verbose

-v

Description

With this option you put the expire cache utility in verbose mode. The utility shows which files are being deleted.

Example

```
expirearm -v --megabytes=0 "installation-dir\mproject\.cache"
```

```
2014-06-24 12:36:15 installation-dir\mproject\.cache\carmcache\cstart\30aa7935
```

```
2014-06-24 12:36:17 installation-dir\mproject\.cache\carmcache\myproject\6f0a3ba4
```

Related information

-

Expire cache utility option: --version (-V)

Command line syntax

`--version`

`-V`

Description

Display version information and exit. The expire cache utility ignores all other options.

Related information

-

Chapter 12. Influencing the Build Time

In general many settings have influence on the build time of a project. Any change in the tool settings of your project source will have more or less impact on the build time. The following sections describe several issues that can have significant influence on the build time.

12.1. MIL Linking

With MIL linking (see [Section 4.5.1, *Generic Optimizations \(frontend\)*](#)) it is possible to let the compiler apply optimizations application wide. This can yield significant optimization improvements, but the build times can also be significantly longer. MIL linking itself can require significant time, but also the changed build process implies longer build times. The MIL linking settings in Eclipse are:

- **Build for application wide optimizations (MIL linking)**

This enables MIL linking. The build process changes: the C files are translated to intermediate code (MIL files) and the generated MIL files of the whole project are linked together by the C compiler. The next step depends on the setting of the option below.

- **Application wide optimization mode: Optimize more/Build slower**

When this option is enabled, the compiler runs the code generator immediately on the completely linked MIL stream, which represents the entire application. This way the code generator can perform several optimizations, such as "code compaction", at application scope. But this also requires significantly more memory and requires more time to generate code. Besides that, it is no longer possible to do incremental builds. With each build the full MIL linking phase and code generation has to be done, even with the smallest change that would in a normal build (not MIL linking) require only a single module to be translated.

- **Application wide optimization mode: Optimize less/Build faster**

When this option is disabled, the compiler splits the MIL stream after MIL linking in separate modules. This allows the code generation to be performed for the modified modules only, and will therefore be faster than with the other option enabled. Although the MIL stream is split in separate modules after MIL linking, it still may happen that modifying a single C source file results in multiple MIL files to be compiled. This is a natural result of global optimizations, where the code generated for multiple modules was affected by the change.

In general, if you do not need code compaction, for example because you are optimizing fully for speed, it is recommended to choose **Optimize less/Build faster**.

12.2. Optimization Options

In general any optimization may require more work to be done by the compiler. But this does not mean that disabling all optimizations (level 0) gives the fastest compilation time. Disabling optimizations may result in more code being generated, resulting in more work for other parts of the compiler, like for example the register allocator.

12.3. Automatic Inlining

Automatic inlining is an optimization which can result in significant longer build time. The overall functions will get bigger, often making it possible to do more optimizations. But also often resulting in more registers to be in use in a function, giving the register allocation a tougher job.

12.4. Code Compaction

When you disable the code compaction optimization, the build times may be shorter. Certainly when MIL linking is used where the full application is passed as a single MIL stream to the code generation. Code compaction is however an optimization which can make a huge difference when optimizing for code size. When size matters it makes no sense to disable this option. When you choose to optimize for speed (`--tradeoff=0`) the code compaction is automatically disabled.

12.5. Compiler Cache

The C compiler has support for caching intermediate results to avoid full compilations. When the source code after preprocessing and relevant compiler options and the compiler version are the same as in a previous invocation, the previous result is copied to the output file. The cache only works when there is a single C input file and a single output file (no `--mil-split`).

To enable caching from Eclipse:

1. From the **Project** menu, select **Properties for**

The Properties dialog appears.

2. In the left pane, expand **C/C++ Build** and select **Settings**.

In the right pane the Settings appear.

3. On the Tool Settings tab, select **C/C++ Compiler » Optimization » Compilation Speed**.

4. Enable the option **Cache generated code to improve the compilation speed**.

5. In the **Directory for cached files** field, enter the name for the location of the cache.

By default this is the .cache directory under your project directory.

6. Specify the **Maximum days files will live in the cache**.

7. (Optional) Enable the option **Clear cache upon project clean**.

*Each time you use **Project » Clean...** the cache is cleared.*

Eclipse calls the C compiler with option `--cache`. The cache directory may be shared, for instance by placing it on a network drive. The compiler creates a directory `carncache` in the specified directory.

When a result from the cache is used, the C compiler generates a comment line in the assembly source file to notify that. In that case be aware of the following:

- In case source merging is enabled an older version of the source is still shown. As long as a source change has no effect on the preprocessed code, the cached version of the output file is used.
- Some options, like `--define`, `--include-directory` and `--output` are not part of the hash used for the cache. As long as a change in these options has no influence on the preprocessed code, the cached version of the output is used. This means that the options listed as comments in the generated assembly file might not match the options actually used.

With every compilation of a file that results in a cache miss, a new file is stored in the cache. Old files are not removed from the cache automatically because that would slow down the compiler too much. To keep the cache size reasonable specify a maximum number of days the files will live in the cache. Eclipse uses the utility `expirearm` for this. It is recommended to run this utility frequently, for example with each time the project is linked. For more information on this utility see [Section 9.6, Expire Cache Utility](#).

12.6. Header Files

Many applications include all header files in each module, often by including them all within a single include file. Processing header files takes time. It is a good programming practice to only include the header files that are really required in a module, because:

- it is clear what interfaces are used by a module
- an incremental build after modifying a header file results in less modules required to be rebuild
- it reduces compile time

12.7. Parallel Build

The make utility `amk`, which is used by Eclipse, has a feature to build jobs in parallel. This means that multiple modules can be compiled in parallel. With today's multi-core processors this means that each core can be fully utilized. In practice even on single core machines the compile time decreases when using parallel jobs. On multi-core machines the build time even improves further when specifying more parallel jobs than the number of cores.

In Eclipse you can control the parallel build behavior:

1. From the **Project** menu, select **Properties for**
The Properties dialog appears.
2. In the left pane, select **C/C++ Build**.
In the right pane the C/C++ Build page appears.
3. On the Behavior tab, select **Enable parallel build**.
4. You can specify the number of parallel jobs, or you can use an optimal number of jobs. In the last case, `amk` will fork as many jobs in parallel as cores are available.

12.8. Number of Sections

The linker speed depends on the number of sections in the object files. The more sections, the longer the locating will take. You can decrease the link time by creating output sections in the LSL file. For example:

Use compiler option `--rename-sections=.text={name}`

```
section_layout ::linear
{
  group (ordered)
  {
    section "code_output1" ( size = 64k, attributes = x, fill=0xFF,
                           overflow = "code_output2")
    {
      select "__cocofun*";
    }
  }
}
```

Chapter 13. Profiling

Profiling is the process of collecting statistical data about a running application. With these data you can analyze which functions are called, how often they are called and what their execution time is. This chapter describes the TASKING profiling method with code instrumentation techniques and static profiling.

13.1. What is Profiling?

Profiling is a collection of methods to gather data about your application which helps you to identify code fragments where execution consumes the greatest amount of time.

TASKING supplies a number of profiler tools each dedicated to solve a particular type of performance tuning problem. Performance problems can be solved by:

- Identifying time-consuming algorithms and rewrite the code using a more time-efficient algorithm.
- Identifying time-consuming functions and select the appropriate compiler optimizations for these functions (for example, enable loop unrolling or function inlining).
- Identifying time consuming loops and add the appropriate pragmas to enable the compiler to further optimize these loops.

A profiler helps you to find and identify the time consuming constructs and provides you this way with valuable information to optimize your application.

TASKING employs various schemes for collecting profiling data, depending on the capabilities of the target system and different information needs.

13.1.1. Methods of Profiling

There are several methods of profiling: recording by an instruction set simulator, profiling with code instrumentation techniques (dynamic profiling) and profiling by the C compiler at compile time (static profiling). Each method has its advantages and disadvantages.

Profiling by an instruction set simulator

One way to gather profiling information is built into the instruction set simulator (ISS). The ISS records the time consumed by each instruction that is executed. The debugger then retrieves this information and correlates the time spent for individual instructions to C source statements.

Advantages

- it gives (cycle) accurate information with extreme fine granularity
- the executed code is identical to the non-profiled code

Disadvantages

- the method requires an ISS as execution environment

Profiling using code instrumentation techniques (Dynamic Profiling)

The TASKING C compiler has an option to add code to your application which takes care of the profiling process. This is called code instrumentation. The gathered profiling data is first stored in the target's memory and will be written to a file when the application finishes execution or when the function `__prof_cleanup()` is called.

Advantages

- it can give a complete call graph of the application annotated with the time spent in each function and basic block
- this profiling method is execution environment independent
- the application is profiled while it executes on its aimed target taking real-life input

Disadvantage

- instrumentation code creates a significant run-time overhead, and instrumentation code and gathered data take up target memory

This method provides a valuable complement to the other two methods and is described into more detail below.

Profiling estimation by the C compiler (Static Profiling)

The TASKING C compiler has an option to generate static profile information through various heuristics and estimates. The profiling data produced this way at compile time is stored in an XML file, which can be processed and displayed using the same tools used for dynamic (run-time) profiling.

Advantages

- it can give a quick estimation of the time spent in each function and basic block
- this profiling method is execution environment independent
- the application is profiled at compile time
- it requires no extra code instrumentation, so no extra run-time overhead

Disadvantage

- it is an estimation by the compiler and therefore less accurate than dynamic profiling

This method also is described into more detail below.

13.2. Profiling using Code Instrumentation (Dynamic Profiling)

Profiling can be used to determine which parts of a program take most of the execution time.

Once the collected data are presented, it may reveal which pieces of your code execute slower than expected and which functions contribute most to the overall execution time of a program. It gives you

also information about which functions are called more or less often than expected. This information not only reveal design flaws or bugs that had otherwise been unnoticed, it also reveals parts of the program which can be effectively optimized.

Important considerations

The dynamic profiling method adds code to your original application which is needed to gather the profiling data. Therefore, the code size of your application increases. Furthermore, during the profiling process, the gathered data is initially stored into dynamically allocated memory of the target. The heap of your application should be large enough to store this data. Since code instrumentation is done by the compiler, assembly functions used in your program do not show up in the profile.

The profiling information is collected during the actual execution of the program. Therefore, the input of the program influences the results. If a part/function of the program is not activated while the program is profiled, no profile data is generated for that part/function.

When you use dynamic profiling on a target board, function `clock()` must be added to the application to get profiling timer results.

It is *not* possible to profile applications that are compiled with the optimization code compaction (C compiler option `--optimize=+compact`). Therefore, when you turn profiling on, the compiler automatically disables parts of the code compaction optimization.

Overview of steps to perform

To obtain a profile using code instrumentation, perform the following steps:

1. Compile and link your program with profiling enabled
2. Execute the program to generate the profile data
3. Display the profile

First you need a completed project. If you are not using your own project, use the `profiling` example as described below.

1. From the **File** menu, select **Import...**

The Import dialog appears.

2. Select **TASKING C/C++ » TASKING ARM Example Projects** and click **Next**.
3. In the **Example projects** box, disable all projects except `profiling`.
4. Click **Finish**.

The `profiling` project should now be visible in the C/C++ view.

13.2.1. Step 1: Build your Application for Profiling

The first step is to add the code that takes care of the profiling, to your application. This is done with C compiler options:

TASKING VX-toolset for ARM User Guide

1. From the **Project** menu, select **Properties for**
The Properties for profiling dialog box appears.
2. In the left pane, expand **C/C++ Build** and select **Settings**.
In the right pane the Settings appear.
3. On the Tool Settings tab, expand the **C/C++ Compiler** entry and select **Debugging**.
4. Enable one or more of the following **Generate profiling information** options (the sample profiling project already has profiling options enabled).

- **for block counters** (not in combination with Call graph or Function timers)
- **to build a call graph** (not in combination with Block counters)
- **for function counters**
- **for function timers** (not in combination with Block counters/Function counters)

Note that the more detailed information you request, the larger the overhead in terms of execution time, code size and heap space needed. The option Generate symbolic debug information (**--debug**) does not affect profiling, execution time or code size.

Block counters (not in combination with Call graph or Function timers)

This will instrument the code to perform basic block counting. As the program runs, it will count how many times it executed each branch of each if statement, each iteration of a for loop, and so on. Note that though you can combine Block counters with Function counters, this has no effect because Function counters is only a subset of Block counters.

Call graph (not in combination with Block counters)

This will instrument the code to reconstruct the run-time call graph. As the program runs it associates the caller with the gathered profiling data.

Function counters

This will instrument the code to perform function call counting. This is a subset of the basic Block counters.

Function timers (not in combination with Block counters/Function counters)

This will instrument the code to measure the time spent in a function. This includes the time spent in all called functions (callees).

For the command line, see the [C compiler option **--profile \(-p\)**](#).

Profiling is only possible with optimization levels 0, 1 and 2. So:

5. Open the **Optimization** page and set the **Optimization level** to **2 - Optimize more**.

- Click **OK** to apply the new option settings and rebuild the project (🔧).

13.2.1.1. Profiling Modules and C Libraries

Profiling individual modules

It is possible to profile individual C modules. In this case only limited profiling data is gathered for the functions in the modules compiled without the profiling option. When you use the suboption **Call graph**, the profiling data reveals which profiled functions are called by non-profiled functions. The profiling data does not show how often and from where the non-profiled functions themselves are called. Though this does not affect the flat profile, it might reduce the usefulness of the call graph.

Profiling C library functions

Eclipse and/or the control program will link your program with the standard version of the C library. Functions from this library which are used in your application, will not be profiled. If you do want to incorporate the library functions in the profile, you must set the appropriate C compiler options in the C library makefiles and rebuild the library.

13.2.1.2. Linking Profiling Libraries

When building your application, the application must be linked against the corresponding profile library. Eclipse (or the control program) automatically select the correct library based on the profiling options you specified. However, if you compile, assemble and link your application manually, make sure you specify the correct library.

See [Section 7.3, *Linking with Libraries*](#) for an overview of the (profiling) libraries.

13.2.2. Step 2: Execute the Application

Once you have compiled and linked the application for profiling, it must be executed to generate the profiling data. Run the program as usual: the program should run normally taking the same input as usual and producing the same output as usual. The application will run somewhat slower than normal because of the extra time spent on collecting the profiling data.

Follow the steps below to run the application on the TASKING simulator, using the debugger. (In fact, you can run the application also on a target board.)

- From the **Debug** menu, select **Debug Configurations...**

The Debug Configurations dialog appears.

- Select **TASKING C/C++ Debugger** and click the **New launch configuration** button (📄) to add a new configuration.
- In the **Name** field enter the name of the configuration. By default, this is the name of the project, but you can give your configuration any name you want to distinguish it from the project name. For example enter `profiling.simulator` to identify the simulator debug configuration.
- On the **Target** tab, select the **ARM Simulator**.

TASKING VX-toolset for ARM User Guide

5. Click the **Apply** button.
6. Click the **Debug** button to start the debugger and launch the profiling application.

Eclipse will open the TASKING Debug perspective (as specified in the configuration) and asks for confirmation.

7. Click **Yes** to open the TASKING Debug perspective.

The TASKING Debug perspective opens while the application has stopped before it enters `main()`

8. From the main toolbar, click on the  (Resume) button.

A file system simulation (FSS) view appears in which the application outputs the results.

When the program has finished, the collected profiling data is saved (for details see 'After execution' below).

Startup code

The startup code initializes the profiling functions by calling the function `__prof_init()`. Eclipse will automatically make the required modifications to the startup code. Or, when you use the control program, this extracts the correct startup code from the C library.

If you use your own startup code, you must manually insert a call to the function `__prof_init` just before the call to `main` and its stack setup.

An application can have multiple entry points, such as `main()` and other functions that are called by interrupt. This does not affect the profiling process.

Small heap problem

When the program does not run as usual, this is typically caused by a shortage of heap space. In this case a message is issued (when running with file system simulation, it is displayed on the Debug console). To solve this problem, increase the size of the heap. Information about the heap is stored in the linker script file (`.lsl`) file which is automatically added when a project is created.

1. From the **Project** menu, select **Properties for**

The Properties dialog appears.

2. In the left pane, expand **C/C++ Build** and select **Stack/Heap**.

In the right pane the Stack/Heap property page appears.

3. Enter larger values for **heap** and click **OK**.

The project LSL file is updated automatically according to the new settings.

Presumable incorrect call graph

The call graph is based on the *compiled* source code. Due to compiler optimizations the call graph may therefor seem incorrect at first sight. For example, the compiler can replace a function call immediately followed by a return instruction by a jump to the callee, thereby merging the callee function with the caller function. In this case the time spent in the callee function is not recorded separately anymore, but added to the time spent in the caller function (which, as said before, now holds the callee function). This represents exactly the structure of your source in assembly but may differ from the structure in the initial C source.

After execution

When the program has finished (returning from `main()`), the exit code calls the function `__prof_cleanup(void)`. This function writes the gathered profiling data to a file on the host system using the debugger's file system simulation features. If your program does *not* return from `main()`, you can force this by inserting a call to the function `__prof_cleanup()` in your application source code. Please note the double underscores when calling from C code!

The resulting profiling data file is named `amon.prf`.

If your program does not run under control of the debugger and therefore cannot use the file system simulation (FSS) functionality to write a file to the host system, you must implement a way to pass the profiling data gathered on the target to the host. Adapt the function `__prof_cleanup()` in the profiling libraries or the underlying I/O functions for this purpose.

13.2.3. Step 3: Displaying Profiling Results

After the function `__prof_cleanup()` has been executed, the result of the profiler can be displayed in the TASKING Profiler perspective. The profiling data in the file `amon.prf` is then converted to an XML file. This file is read and its information is displayed. To view the profiling information, open the TASKING Profiler perspective:

1. From the **Window** menu, select **Open Perspective » Other...**

The Open Perspective dialog appears.

2. Select the **TASKING Profiler** perspective and click **OK**.

The TASKING Profiler perspective opens.

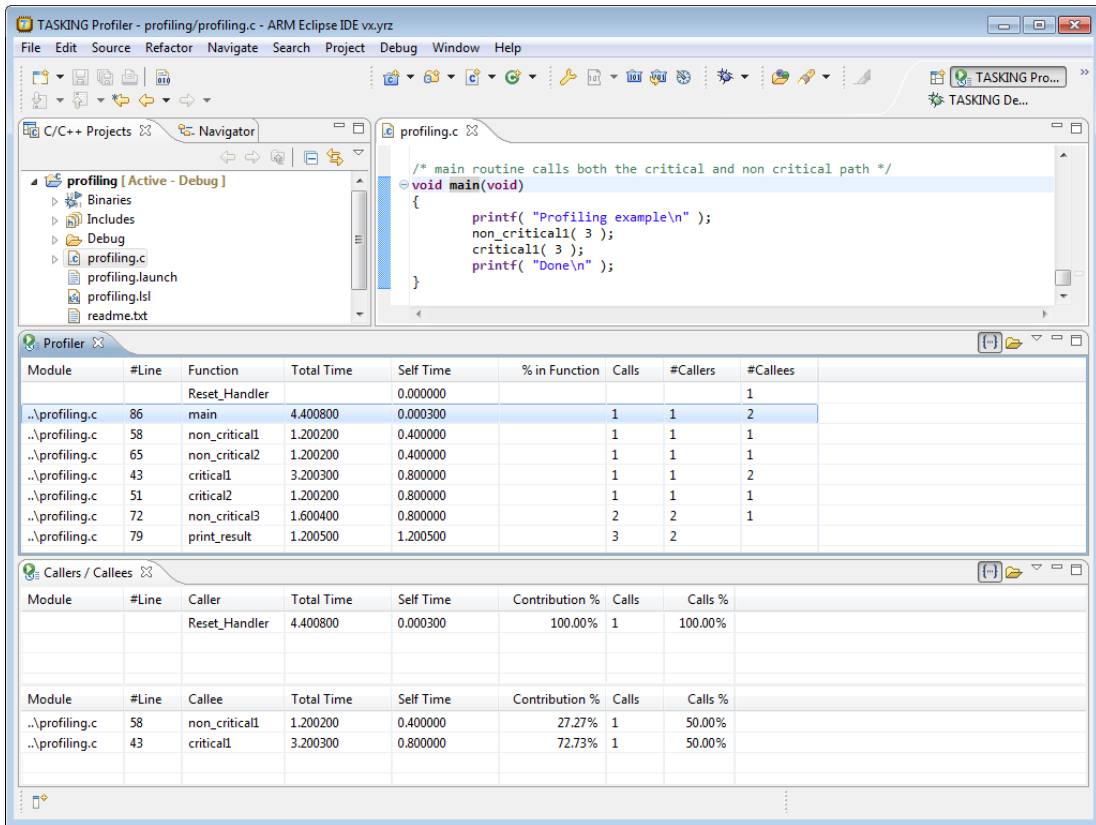

The TASKING Profiler perspective

The TASKING Profiler perspective contains the following Views:

Profiler view Shows the profiling information of all functions in all C source modules belonging to your application.

Callers / Callees view The first table in this view, the *callers* table, shows the functions that called the focus function.

The second table in this view, the *callees* table, shows the functions that are called by the focus function.

- Clicking on a function (or on its table row) makes it the focus function.
- Double-clicking on a function, opens the appropriate C source module in the Editor view at the location of the function definition.
- To sort the rows in the table, click on one of the column headers.

The profiling information



Based on the profiling options you have set before compiling your application, some profiling data may be present and some may be not. The columns in the tables represent the following information:

Module	The C source module in which the function resides.
#Line	The line number of the function definition in the C source module.
Function	The function for which profiling data is gathered and (if present) the code blocks in each function. To show or hide the block counts, in the Profiler view click the Menu button (☰) and select Show Block Counts .
Total Time	The total amount of time in seconds that was spent in this function and all of its sub-functions.
Self Time	The amount of time in seconds that was spent in the function itself. This excludes the time spent in the sub-functions. So, self time = function's total time - total times of the called functions.
% in Function	This is the relative amount of time spent in this function, calculated as a percentage of the total application time. These should add up to 100%. The total application time is determined by taking the total time of the call graph. This is usually main. Example:

```
Total time of main: 0.002000
Self time of function foo: 0.000100
%in Function = (0.000100 / 0.002000) * 100 = 5%
```

Calls	Number of times the function has been executed.
#Callers	Number of functions by which the function was called.
#Callees	Number of functions that was actually called from this function.
Contribution %	In the caller table: shows for which part (in percent) the caller contributes to the time spent in the focus function. In the callee table: shows how much time the focus function has spent relatively in each of its callees.
Calls %	In the caller table: shows how often each callee was called as a percentage of all calls from the focus function. In the callee table: shows how often the focus function was called from a particular caller as a percentage of all calls to the focus function.

Common toolbar icons

Icon	Action	Description
	Show/Hide Block Counts	Toggle. If enabled, shows profiling information for block counters.
	Select Profiling File(s)	Opens a dialog where you can specify profiling files for display.

Viewing previously recorded profiling results, combining results

Each time you run your application, new profiling information is gathered and stored in the file `amon.prf`. You can store previous results by renaming the file `amon.prf` (keep the extension `.prf`); this prevents the existing `amon.prf` from being overwritten by the new `amon.prf`. At any time, you can reload these profiling results in the profiler. You can even load multiple `.prf` files into the Profiler to view the combined results.

First, open the TASKING Profiler perspective if it is not open anymore:

1. In the Profiler view, click on the  (Select Profiling File(s)) button.
The Select Profiling File(s) dialog appears.
2. In the **Profiling Type** group box, select **Dynamic Profiling**.
3. In the **Profiling Files** group box, disable the option **Use default**.
4. Click the **Add...** button, select the `.prf` files you want to load and click **Open** to confirm your choice.
5. Make sure the correct symbol file is selected, in this example `profiling.abs`.
6. Click **OK** to finish.

13.3. Profiling at Compile Time (Static Profiling)

Just as with dynamic profiling, static profiling can be used to determine which parts of a program take most of the execution time. It can provide a good alternative if you do not want that your code is affected by extra code.

Overview of steps to perform

To obtain a profile using code instrumentation, perform the following steps:

1. Compile and link your program with static profiling enabled
2. Display the profile

First you need a completed project. If you are not using your own project, use the `profiling` example as described in [Section 13.2, Profiling using Code Instrumentation \(Dynamic Profiling\)](#).

13.3.1. Step 1: Build your Application with Static Profiling

The first step is to tell the C compiler to make an estimation of the profiling information of your application. This is done with C compiler options:

1. From the **Project** menu, select **Properties for**
The Properties for profiling dialog box appears.
2. In the left pane, expand **C/C++ Build** and select **Settings**.

In the right pane the Settings appear.

3. On the Tool Settings tab, expand the **C/C++ Compiler** entry and select **Debugging**.
4. Enable **Static profiling**.

For the command line, see the [C compiler option --profile \(-p\)](#).

Profiling is only possible with optimization levels 0, 1 and 2. So:

5. Open the **Optimization** page and set the **Optimization level to 2 - Optimize more**.
6. Click **OK** to apply the new option settings and rebuild the project ().

13.3.2. Step 2: Displaying Static Profiling Results

After your project has been built with static profiling, the result of the profiler can be displayed in the TASKING Profiler perspective. The profiling data of each individual file (.sxml), is combined in the XML file `profiling.xprof`. This file is read and its information is displayed. To view the profiling information, open the TASKING Profiler perspective:

1. From the **Window** menu, select **Open Perspective » Other...**

The Open Perspective dialog appears.

2. Select the **TASKING Profiler** perspective and click **OK**.

The TASKING Profiler perspective opens. This perspective is explained in [Section 13.2.3, Step 3: Displaying Profiling Results](#)

To display static profiling information in the Profiler view

1. In the Profiler view, click on the  (Select Profiling File(s)) button.

The Select Profiling File(s) dialog appears.

2. In the **Profiling Type** group box, select **Static Profiling**.
3. In the **Static Profiling File** group box, enable the option **Use default**.

By default, the file `project.xprof` is used (`profiling.xprof`). If you want to specify another file, disable the option **Use default** and use the edit field and/or Browse button to specify a static profiling file (.xprof).

4. Click **OK** to finish.

Chapter 14. Libraries

This chapter contains an overview of all library functions that you can call in your C source. This includes all functions of the standard C library (ISO C99) and some functions of the floating-point library.

A number of standard operations within C are too complex to generate inline code for (too much code). These operations are implemented as run-time library functions to save code.

[Section 14.2, *Library Functions*](#), gives an overview of all library functions you can use, grouped per header file. A number of functions declared in `wchar.h` are parallel to functions in other header files. These are discussed together.

[Section 14.3, *C Library Reentrancy*](#), gives an overview of which functions are reentrant and which are not.

C library / floating-point library / run-time library

The following libraries are included in the ARM toolset. Both Eclipse and the control program `ccarm` automatically select the appropriate libraries depending on the specified options.

Libraries	Description
carm[s].lib cthumb[s].lib	C libraries for ARM and Thumb instructions respectively Optional letter: s = single precision floating-point (control program option <code>--fp-model=+float</code>)
fparm.lib fpthumb.lib	Floating-point libraries for ARM and Thumb (contains floating-point functions needed by the C compiler)
rtarm.lib rtthumb.lib	Run-time library for ARM and Thumb (contains other run-time functions needed by the C compiler)
pbarm.lib / pbthumb.lib pcarm.lib / pctthumb.lib pctarm.lib / pctthumb.lib pdarm.lib / pdthumb.lib ptarm.lib / ptthumb.lib	Profiling libraries for ARM and Thumb pb = block/function counter pc = call graph pct = call graph and timing pd = dummy pt = function timing
dsptthumb[s].lib	CMSIS DSP libraries Optional letter: s = single precision floating-point

For the C libraries, profiling libraries and CMIS DPS libraries, also MIL library variants are present (files with extension `.ma`).

Sources for the libraries are present in the directories `lib\src`, `lib\src.*` in the form of an executable. If you run the executable it will extract the sources in the corresponding directory.

C++ Library

The TASKING C++ compiler supports the STLport C++ libraries. STLport is a multi-platform ISO C++ Standard Library implementation. It is a free, open-source product, which is delivered with the TASKING C++ compiler. The library supports standard templates and I/O streams.

The include files for the STLport C++ libraries are present in directory `include.stl` relative to the product installation directory.

You can find more information on the STLport library on the following site:<http://stlport.sourceforge.net/>

Also read the license agreement on <http://stlport.sourceforge.net/License.shtml>. This license agreement is applicable to the STLport C++ library only. All other product components fall under the TASKING license agreement.

For an STL Programmer's Guide you can see <http://www.sgi.com/tech/stl/index.html>

The following C++ libraries are delivered with the product:

Libraries	Description
<code>cparm[s][x].lib</code> <code>cpthumb[s][x].lib</code>	C++ libraries for ARM and Thumb Optional letter: s = single precision floating-point x = exception handling
<code>stlarmx.lib</code> <code>stlthumbx.lib</code>	STLport C++ libraries (exception handling variants only)

To build an STLport library

1. Change to the directory
`installdir\lib\src.stl[v6M][v7EM][v7M][v7R]\[le][be][be32]\stl[arm|thumb]x`,
depending on the library set used by your project.
2. Run the `makefile` by executing `installdir\bin\amk.exe` without arguments.
3. Copy the generated C++ library `stl[arm|thumb]x.lib` to the corresponding directory
`installdir\lib\[v6M][v7EM][v7M][v7R]\[le][be][be32]`.

where,

[<i>v6M</i>]	libraries for ARMv6-M architectures
[<i>v7EM</i>]	libraries for ARMv7E-M architectures
[<i>v7M</i>]	libraries for ARMv7-M architectures
[<i>v7R</i>]	libraries for ARMv7-R architectures
[<i>le</i>]	little-endian library variant
[<i>be</i>]	big-endian library variant
[<i>be32</i>]	big-endian 32 library variant

14.1. Using the CMSIS DSP Library

Part of the CMSIS standard is a DSP library. The CMSIS DSP library is included in the TASKING product's `cmsis` folder. The library is also available as a pre-built library file in the `lib` folders for v6M, v7M and v7EM. The libraries are `dsptthumb.lib` (double precision floating point) and `dsptthumbs.lib` (single precision floating point). MIL libraries are present also: `dsptthumb.ma` and `dsptthumbs.ma`.

To use the CMSIS DSP library in your Eclipse project

1. From the **Project** menu, select **Properties for**
The Properties dialog appears.
2. In the left pane, expand **C/C++ Build** and select **Settings**.
In the right pane the Settings appear.
3. On the Tool Settings tab, select **C/C++ Compiler » Include Paths** .
4. Enable the option **Add CMSIS include paths**.
5. On the Tool Settings tab, select **Linker » Libraries**.
6. Enable the option **Link CMSIS DSP library**.

*This passes the option **--dsp-library** of the control program (**ccarm**) for compilation of C/C++ files and for linking. With this option the control program sets the compiler macro `ARM_MATH_CM0`, `ARM_MATH_CM0PLUS`, `ARM_MATH_CM3` or `ARM_MATH_CM4` or `ARM_MATH_CM7`, depending on the selected processor. These macros are required for the CMSIS `arm_math.h` header file to operate correctly. With **--dsp-library** the control program also selects the appropriate library.*

14.2. Library Functions

The tables in the sections below list all library functions, grouped per header file in which they are declared. Some functions are not completely implemented because their implementation depends on the context where your application will run. These functions are for example all I/O related functions. Where possible, these functions are implemented using file system simulation (FSS). This system can be used by the debugger to simulate an I/O environment which enables you to debug your application.

Wide-character functionality is supported in the C library.

14.2.1. `assert.h`

`assert(expr)` Prints a diagnostic message if `NDEBUG` is not defined. (Implemented as macro)

14.2.2. complex.h

The complex number z is also written as $x+yi$ where x (the real part) and y (the imaginary part) are real numbers of types `float`, `double` or `long double`. The real and imaginary part can be stored in structs or in arrays. This implementation uses arrays because structs may have different alignments.

The header file `complex.h` also defines the following macros for backward compatibility:

```
complex    _Complex    /* C99 keyword */
imaginary  _Imaginary  /* C99 keyword */
```

Parallel sets of functions are defined for `double`, `float` and `long double`. They are respectively named *function*, *functionf*, *functionl*. All long type functions, though declared in `complex.h`, are implemented as the `double` type variant which nearly always meets the requirement in embedded applications.

This implementation uses the obvious implementation for complex multiplication; and a more sophisticated implementation for division and absolute value calculations which handles underflow, overflow and infinities with more care. The ISO C99 `#pragma CX_LIMITED_RANGE` therefore has no effect.

Trigonometric functions

<code>csin</code>	<code>csinf</code>	<code>csinl</code>	Returns the complex sine of z .
<code>ccos</code>	<code>ccosf</code>	<code>ccosl</code>	Returns the complex cosine of z .
<code>ctan</code>	<code>ctanf</code>	<code>ctanl</code>	Returns the complex tangent of z .
<code>casin</code>	<code>casinf</code>	<code>casinl</code>	Returns the complex arc sine $\sin^{-1}(z)$.
<code>cacos</code>	<code>cacosf</code>	<code>cacosl</code>	Returns the complex arc cosine $\cos^{-1}(z)$.
<code>catan</code>	<code>catanf</code>	<code>catanl</code>	Returns the complex arc tangent $\tan^{-1}(z)$.
<code>csinh</code>	<code>csinhf</code>	<code>csinhl</code>	Returns the complex hyperbolic sine of z .
<code>ccosh</code>	<code>ccoshf</code>	<code>ccoshl</code>	Returns the complex hyperbolic cosine of z .
<code>ctanh</code>	<code>ctanhf</code>	<code>ctanhl</code>	Returns the complex hyperbolic tangent of z .
<code>casinh</code>	<code>casinhf</code>	<code>casinhl</code>	Returns the complex arc hyperbolic sine of z .
<code>cacosh</code>	<code>cacoshf</code>	<code>cacoshl</code>	Returns the complex arc hyperbolic cosine of z .
<code>catanh</code>	<code>catanhf</code>	<code>catanhl</code>	Returns the complex arc hyperbolic tangent of z .

Exponential and logarithmic functions

<code>cexp</code>	<code>cexpf</code>	<code>cexpl</code>	Returns the result of the complex exponential function e^z .
<code>clog</code>	<code>clogf</code>	<code>clogl</code>	Returns the complex natural logarithm.

Power and absolute-value functions

<code>cabs</code>	<code>cabsf</code>	<code>cabsl</code>	Returns the complex absolute value of z (also known as <i>norm</i> , <i>modulus</i> or <i>magnitude</i>).
<code>cpow</code>	<code>cpowf</code>	<code>cpowl</code>	Returns the complex value of x raised to the power y (x^y) where both x and y are complex numbers.

`csqrt` `csqrtf` `csqrtl` Returns the complex square root of `z`.

Manipulation functions

`carg` `cargf` `cargl` Returns the argument of `z` (also known as *phase angle*).

`cimag` `cimagf` `cimagl` Returns the imaginary part of `z` as a real (respectively as a `double`, `float`, `long double`)

`conj` `conjf` `conjl` Returns the complex conjugate value (the sign of its imaginary part is reversed).

`cproj` `cprojf` `cprojl` Returns the value of the projection of `z` onto the Riemann sphere.

`creal` `crealf` `creall` Returns the real part of `z` as a real (respectively as a `double`, `float`, `long double`)

14.2.3. `ctype.h` and `wctype.h`

The header file `ctype.h` declares the following functions which take a character `c` as an integer type argument. The header file `wctype.h` declares parallel wide-character functions which take a character `c` of the `wchar_t` type as argument.

<code>ctype.h</code>	<code>wctype.h</code>	Description
<code>isalnum</code>	<code>iswalnum</code>	Returns a non-zero value when <code>c</code> is an alphabetic character or a number (<code>[A-Z][a-z][0-9]</code>).
<code>isalpha</code>	<code>iswalpha</code>	Returns a non-zero value when <code>c</code> is an alphabetic character (<code>[A-Z][a-z]</code>).
<code>isblank</code>	<code>iswblank</code>	Returns a non-zero value when <code>c</code> is a blank character (tab, space...)
<code>iscntrl</code>	<code>iswcntrl</code>	Returns a non-zero value when <code>c</code> is a control character.
<code>isdigit</code>	<code>iswdigit</code>	Returns a non-zero value when <code>c</code> is a numeric character (<code>[0-9]</code>).
<code>isgraph</code>	<code>iswgraph</code>	Returns a non-zero value when <code>c</code> is printable, but not a space.
<code>islower</code>	<code>iswlower</code>	Returns a non-zero value when <code>c</code> is a lowercase character (<code>[a-z]</code>).
<code>isprint</code>	<code>iswprint</code>	Returns a non-zero value when <code>c</code> is printable, including spaces.
<code>ispunct</code>	<code>iswpunct</code>	Returns a non-zero value when <code>c</code> is a punctuation character (such as <code>!', ', '!)</code> .
<code>isspace</code>	<code>iswspace</code>	Returns a non-zero value when <code>c</code> is a space type character (space, tab, vertical tab, formfeed, linefeed, carriage return).
<code>isupper</code>	<code>iswupper</code>	Returns a non-zero value when <code>c</code> is an uppercase character (<code>[A-Z]</code>).
<code>isxdigit</code>	<code>iswxdigit</code>	Returns a non-zero value when <code>c</code> is a hexadecimal digit (<code>[0-9][A-F][a-f]</code>).
<code>tolower</code>	<code>towlower</code>	Returns <code>c</code> converted to a lowercase character if it is an uppercase character, otherwise <code>c</code> is returned.
<code>toupper</code>	<code>towupper</code>	Returns <code>c</code> converted to an uppercase character if it is a lowercase character, otherwise <code>c</code> is returned.

ctype.h	wctype.h	Description
<code>_tolower</code>	-	Converts <i>c</i> to a lowercase character, does not check if <i>c</i> really is an uppercase character. Implemented as macro. This macro function is not defined in ISO C99.
<code>_toupper</code>	-	Converts <i>c</i> to an uppercase character, does not check if <i>c</i> really is a lowercase character. Implemented as macro. This macro function is not defined in ISO C99.
<code>isascii</code>		Returns a non-zero value when <i>c</i> is in the range of 0 and 127. This function is not defined in ISO C99.
<code>toascii</code>		Converts <i>c</i> to an ASCII value (strip highest bit). This function is not defined in ISO C99.

14.2.4. dbg.h

The header file `dbg.h` contains the debugger call interface for file system simulation. It contains low level functions. This header file is not defined in ISO C99.

<code>_dbg_trap</code>	Low level function to trap debug events
<code>_argcv(const char *buf, size_t size)</code>	Low level function for command line argument passing

14.2.5. errno.h

`int errno` External variable that holds implementation defined error codes.

The following error codes are defined as macros in `errno.h`:

<code>EPERM</code>	1	Operation not permitted
<code>ENOENT</code>	2	No such file or directory
<code>EINTR</code>	3	Interrupted system call
<code>EIO</code>	4	I/O error
<code>EBADF</code>	5	Bad file number
<code>EAGAIN</code>	6	No more processes
<code>ENOMEM</code>	7	Not enough core
<code>EACCES</code>	8	Permission denied
<code>EFAULT</code>	9	Bad address
<code>EEXIST</code>	10	File exists
<code>ENOTDIR</code>	11	Not a directory
<code>EISDIR</code>	12	Is a directory
<code>EINVAL</code>	13	Invalid argument
<code>ENFILE</code>	14	File table overflow
<code>EMFILE</code>	15	Too many open files
<code>ETXTBSY</code>	16	Text file busy
<code>ENOSPC</code>	17	No space left on device
<code>ESPIPE</code>	18	Illegal seek
<code>EROFS</code>	19	Read-only file system
<code>EPIPE</code>	20	Broken pipe

ELOOP	21	Too many levels of symbolic links
ENAMETOOLONG	22	File name too long

Floating-point errors

EDOM	23	Argument too large
ERANGE	24	Result too large

Errors returned by printf/scanf

ERR_FORMAT	25	Illegal format string for printf/scanf
ERR_NOFLOAT	26	Floating-point not supported
ERR_NOLONG	27	Long not supported
ERR_NOPOINT	28	Pointers not supported

Encoding errors set by functions like fgetc, getwc, mbrtowc, etc ...

EILSEQ	29	Invalid or incomplete multibyte or wide character
--------	----	---

Errors returned by RTOS

ECANCELED	30	Operation canceled
ENODEV	31	No such device

14.2.6. except.h

The header file `except.h` contains the ARM specific software floating-point exception handling interface definition. This header file is not defined in ISO C99.

```

_fp_install_trap_handler(   Installs a floating-point trap handler.
void (*) (
    _fp_exception_info_t * )
exception )

_fp_get_exception_mask(     Returns the exception mask.
void )

_fp_set_exception_mask( int Sets the exception mask. A value of 0xFF traps all floating-point
)                             exceptions.

_fp_get_exception_status(   Returns the exception status.
void )

_fp_set_exception_status(   Sets the exception status.
int )name)

```

For each supported exception, a macro is defined. The following exceptions are defined:

EFINVOP	0x01	Invalid operation, for instance 0.0/0.0, 0.0*INF or on a NaN
EFDIVZ	0x02	Division by zero, for instance 12.5/0.0 (not 0.0/0.0)
EFOVFL	0x04	Overflow, when the result of an operation is too large
EFUNFL	0x08	Underflow, when the result of an operation is too small

TASKING VX-toolset for ARM User Guide

EFINEXCT	0x10	Inexact
EFALL	0x1f	Combination of all of the above enlisted exceptions

INF means infinite which is the largest absolute floating-point number.

NAN means Not A Number, this is a special notation for an undefined floating-point number.

14.2.7. fcntl.h

The header file `fcntl.h` contains the function `open()`, which calls the low level function `_open()`, and definitions of flags used by the low level function `_open()`. This header file is not defined in ISO C99.

<code>open</code>	Opens a file a file for reading or writing. Calls <code>_open</code> . (FSS implementation)
-------------------	--

14.2.8. fenv.h

Contains mechanisms to control the floating-point environment.

<code>fegetenv</code>	Stores the current floating-point environment.
<code>feholdexcept</code>	Saves the current floating-point environment and installs an environment that ignores all floating-point exceptions.
<code>fesetenv</code>	Restores a previously saved (<code>fegetenv</code> or <code>feholdexcept</code>) floating-point environment.
<code>feupdateenv</code>	Saves the currently raised floating-point exceptions, restores a previously saved floating-point environment and finally raises the saved exceptions.
<code>feclearexcept</code>	Clears the current exception status flags corresponding to the flags specified in the argument.
<code>fegetexceptflag</code>	Stores the current setting of the floating-point status flags.
<code>feraiseexcept</code>	Raises the exceptions represented in the argument. As a result, other exceptions may be raised as well.
<code>fesetexceptflag</code>	Sets the current floating-point status flags.
<code>fetestexcept</code>	Returns the bitwise-OR of the exception macros corresponding to the exception flags which are currently set <i>and</i> are specified in the argument.

For each supported exception, a macro is defined. The following exceptions are defined:

<code>FE_DIVBYZERO</code>	<code>FE_INEXACT</code>	<code>FE_INVALID</code>
<code>FE_OVERFLOW</code>	<code>FE_UNDERFLOW</code>	<code>FE_ALL_EXCEPT</code>

<code>fegetround</code>	Returns the current rounding direction, represented as one of the values of the rounding direction macros.
<code>fesetround</code>	Sets the current rounding directions.

For each supported rounding mode, a macro is defined. The following rounding mode macro is defined:

`FE_TONEAREST`

14.2.9. float.h

The header file `float.h` defines the characteristics of the real floating-point types `float`, `double` and `long double`.

`float.h` used to contain prototypes for the functions `copysign(f)`, `isinf(f)`, `isfinite(f)`, `isnan(f)` and `scalb(f)`. These functions have accordingly to the ISO C99 standard been moved to the header file `math.h`. See also [Section 14.2.16, `math.h` and `tgmath.h`](#).

The following functions are only available for ISO C90:

<code>copysignf(float f, float s)</code>	Copies the sign of the second argument <code>s</code> to the value of the first argument <code>f</code> and returns the result.
<code>copysign(double d, double s)</code>	Copies the sign of the second argument <code>s</code> to the value of the first argument <code>d</code> and returns the result.
<code>isinf(float f)</code>	Test the variable <code>f</code> on being an infinite (IEEE-754) value.
<code>isinf(double d);</code>	Test the variable <code>d</code> on being an infinite (IEEE-754) value.
<code>isfinite(float f)</code>	Test the variable <code>f</code> on being a finite (IEEE-754) value.
<code>isfinite(double d)</code>	Test the variable <code>d</code> on being a finite (IEEE-754) value.
<code>isnan(float f)</code>	Test the variable <code>f</code> on being NaN (Not a Number, IEEE-754) .
<code>isnan(double d)</code>	Test the variable <code>d</code> on being NaN (Not a Number, IEEE-754) .
<code>scalbf(float f, int p)</code>	Returns $f * 2^p$ for integral values without computing 2^N .
<code>scalb(double d, int p)</code>	Returns $d * 2^p$ for integral values without computing 2^N . (See also <code>scalbn</code> in Section 14.2.16, <code>math.h</code> and <code>tgmath.h</code>)

14.2.10. inttypes.h and stdint.h

The header files `stdint.h` and `inttypes.h` provide additional declarations for integer types and have various characteristics. The `stdint.h` header file contains basic definitions of integer types of certain sizes, and corresponding sets of macros. This header file clearly refers to the corresponding sections in the ISO C99 standard.

The `inttypes.h` header file includes `stdint.h` and adds portable formatting and conversion functions. Below the conversion functions from `inttypes.h` are listed.

<code>imaxabs(intmax_t j)</code>	Returns the absolute value of <code>j</code>
<code>imaxdiv(intmax_t numer, intmax_t denom)</code>	Computes <code>numer/denom</code> and <code>numer % denom</code> . The result is stored in the <code>quot</code> and <code>rem</code> components of the <code>imaxdiv_t</code> structure type.
<code>strtoimax(const char * restrict nptr, char ** restrict endp, int base)</code>	Convert string to maximum sized integer. (Compare <code>strtoll</code>)
<code>strtoumax(const char * restrict nptr, char ** restrict endp, int base)</code>	Convert string to maximum sized unsigned integer. (Compare <code>strtoull</code>)

TASKING VX-toolset for ARM User Guide

<code>wcstoimax(const wchar_t * restrict nptr, wchar_t ** restrict endptr, int base)</code>	Convert wide string to maximum sized integer. (Compare <code>wcstoll</code>)
<code>wcstoumax(const wchar_t * restrict nptr, wchar_t ** restrict endptr, int base)</code>	Convert wide string to maximum sized unsigned integer. (Compare <code>wcstoull</code>)

14.2.11. io.h

The header file `io.h` contains prototypes for low level I/O functions. This header file is not defined in ISO C99.

<code>_close(fd)</code>	Used by the functions <code>close</code> and <code>fclose</code> . (<i>FSS implementation</i>)
<code>_lseek(fd, offset, whence)</code>	Used by all file positioning functions: <code>fgetpos</code> , <code>fseek</code> , <code>fsetpos</code> , <code>ftell</code> , <code>rewind</code> . (<i>FSS implementation</i>)
<code>_open(fd, flags)</code>	Used by the functions <code>fopen</code> and <code>freopen</code> . (<i>FSS implementation</i>)
<code>_read(fd, *buff, cnt)</code>	Reads a sequence of characters from a file. (<i>FSS implementation</i>)
<code>_unlink(*name)</code>	Used by the function <code>remove</code> . (<i>FSS implementation</i>)
<code>_write(fd, *buffer, cnt)</code>	Writes a sequence of characters to a file. (<i>FSS implementation</i>)

14.2.12. iso646.h

The header file `iso646.h` adds tokens that can be used instead of regular operator tokens.

```
#define and      &&  
#define and_eq  &=  
#define bitand  &  
#define bitor   |  
#define compl   ~  
#define not     !  
#define not_eq  !=  
#define or      ||  
#define or_eq   |=  
#define xor     ^  
#define xor_eq  ^=
```

14.2.13. limits.h

Contains the sizes of integral types, defined as macros.

14.2.14. locale.h

To keep C code reasonable portable across different languages and cultures, a number of facilities are provided in the header file `locale.h`.

```
char *setlocale( int category, const char *locale )
```

The function above changes locale-specific features of the run-time library as specified by the category to change and the name of the locale.

The following categories are defined and can be used as input for this function:

LC_ALL	0	LC_NUMERIC	3
LC_COLLATE	1	LC_TIME	4
LC_CTYPE	2	LC_MONETARY	5

```
struct lconv *localeconv( void )
```

Returns a pointer to type `struct lconv` with values appropriate for the formatting of numeric quantities according to the rules of the current locale. The `struct lconv` in this header file is conforming the ISO standard.

14.2.15. malloc.h

The header file `malloc.h` contains prototypes for memory allocation functions. This include file is not defined in ISO C99, it is included for backwards compatibility with ISO C90. For ISO C99, the memory allocation functions are part of `stdlib.h`. See [Section 14.2.24, `stdlib.h` and `wchar.h`](#).

<code>malloc(size)</code>	Allocates space for an object with size <i>size</i> . The allocated space is not initialized. Returns a pointer to the allocated space.
<code>calloc(nobj, size)</code>	Allocates space for n objects with size <i>size</i> . The allocated space is initialized with zeros. Returns a pointer to the allocated space.
<code>free(*ptr)</code>	Deallocates the memory space pointed to by <i>ptr</i> which should be a pointer earlier returned by the <code>malloc</code> or <code>calloc</code> function.
<code>realloc(*ptr, size)</code>	Deallocates the old object pointed to by <i>ptr</i> and returns a pointer to a new object with size <i>size</i> , while preserving its contents. If the new size is smaller than the old size, some contents at the end of the old region will be discarded. If the new size is larger than the old size, all of the old contents are preserved and any bytes in the new object beyond the size of the old object will have indeterminate values.

14.2.16. math.h and tgmth.h

The header file `math.h` contains the prototypes for many mathematical functions. Before ISO C99, all functions were computed using the double type (the float was automatically converted to double, prior to calculation). In this ISO C99 version, parallel sets of functions are defined for `double`, `float` and `long double`. They are respectively named *function*, *functionf*, *functionl*. All `long` type functions, though declared in `math.h`, are implemented as the `double` type variant which nearly always meets the requirement in embedded applications.

The header file `tgmath.h` contains parallel type generic math macros whose expansion depends on the used type. `tgmath.h` includes `math.h` and the effect of expansion is that the correct `math.h` functions are called. The type generic macro, if available, is listed in the second column of the tables below.

Trigonometric and hyperbolic functions

math.h			tgmath.h	Description
<code>sin</code>	<code>sinf</code>	<code>sinl</code>	<code>sin</code>	Returns the sine of x .
<code>cos</code>	<code>cosf</code>	<code>cosl</code>	<code>cos</code>	Returns the cosine of x .
<code>tan</code>	<code>tanf</code>	<code>tanl</code>	<code>tan</code>	Returns the tangent of x .
<code>asin</code>	<code>asinf</code>	<code>asinl</code>	<code>asin</code>	Returns the arc sine $\sin^{-1}(x)$ of x .
<code>acos</code>	<code>acosf</code>	<code>acosl</code>	<code>acos</code>	Returns the arc cosine $\cos^{-1}(x)$ of x .
<code>atan</code>	<code>atanf</code>	<code>atanl</code>	<code>atan</code>	Returns the arc tangent $\tan^{-1}(x)$ of x .
<code>atan2</code>	<code>atan2f</code>	<code>atan2l</code>	<code>atan2</code>	Returns the result of: $\tan^{-1}(y/x)$.
<code>sinh</code>	<code>sinhf</code>	<code>sinhl</code>	<code>sinh</code>	Returns the hyperbolic sine of x .
<code>cosh</code>	<code>coshf</code>	<code>coshl</code>	<code>cosh</code>	Returns the hyperbolic cosine of x .
<code>tanh</code>	<code>tanhf</code>	<code>tanh1</code>	<code>tanh</code>	Returns the hyperbolic tangent of x .
<code>asinh</code>	<code>asinhf</code>	<code>asinh1</code>	<code>asinh</code>	Returns the arc hyperbolic sine of x .
<code>acosh</code>	<code>acoshf</code>	<code>acosh1</code>	<code>acosh</code>	Returns the non-negative arc hyperbolic cosine of x .
<code>atanh</code>	<code>atanhf</code>	<code>atanh1</code>	<code>atanh</code>	Returns the arc hyperbolic tangent of x .

Exponential and logarithmic functions

All of these functions are new in ISO C99, except for `exp`, `log` and `log10`.

math.h			tgmath.h	Description
<code>exp</code>	<code>expf</code>	<code>expl</code>	<code>exp</code>	Returns the result of the exponential function e^x .
<code>exp2</code>	<code>exp2f</code>	<code>exp2l</code>	<code>exp2</code>	Returns the result of the exponential function 2^x .
<code>expm1</code>	<code>expm1f</code>	<code>expm1l</code>	<code>expm1</code>	Returns the result of the exponential function $e^x - 1$.
<code>log</code>	<code>logf</code>	<code>logl</code>	<code>log</code>	Returns the natural logarithm $\ln(x)$, $x > 0$.
<code>log10</code>	<code>log10f</code>	<code>log10l</code>	<code>log10</code>	Returns the base-10 logarithm of x , $x > 0$.
<code>log1p</code>	<code>log1pf</code>	<code>log1pl</code>	<code>log1p</code>	Returns the base-e logarithm of $(1+x)$. $x < > -1$.
<code>log2</code>	<code>log2f</code>	<code>log2l</code>	<code>log2</code>	Returns the base-2 logarithm of x . $x > 0$.
<code>ilogb</code>	<code>ilogbf</code>	<code>ilogbl</code>	<code>ilogb</code>	Returns the signed exponent of x as an integer. $x > 0$.
<code>logb</code>	<code>logbf</code>	<code>logbl</code>	<code>logb</code>	Returns the exponent of x as a signed integer in value in floating-point notation. $x > 0$.

frexp, ldexp, modf, scalbn, scalbln

math.h	tgmth.h			Description
frexp	frexpf	frexpl	frexp	Splits a float x into fraction f and exponent n , so that: $f = 0.0$ or $0.5 \leq f \leq 1.0$ and $f \cdot 2^n = x$. Returns f , stores n .
ldexp	ldexpf	ldexpl	ldexp	Inverse of <code>frexp</code> . Returns the result of $x \cdot 2^n$. (x and n are both arguments).
modf	modff	modfl	-	Splits a float x into fraction f and integer n , so that: $ f < 1.0$ and $f+n=x$. Returns f , stores n .
scalbn	scalbnf	scalbnl	scalbn	Computes the result of $x \cdot \text{FLT_RADIX}^n$. efficiently, not normally by computing FLT_RADIX^n explicitly.
scalbln	scalblnf	scalblnl	scalbln	Same as <code>scalbn</code> but with argument n as <code>long int</code> .

Rounding functions

math.h	tgmth.h			Description
ceil	ceilf	ceill	ceil	Returns the smallest integer not less than x , as a double.
floor	floorf	floorl	floor	Returns the largest integer not greater than x , as a double.
rint	rintf	rintl	rint	Returns the rounded integer value as an <code>int</code> according to the current rounding direction. See <code>fenv.h</code> .
lrint	lrintf	lrintl	lrint	Returns the rounded integer value as a <code>long int</code> according to the current rounding direction. See <code>fenv.h</code> .
llrint	llrintf	llrintl	llrint	Returns the rounded integer value as a <code>long long int</code> according to the current rounding direction. See <code>fenv.h</code> .
nearbyint	nearbyintf	nearbyintl	nearbyint	Returns the rounded integer value as a floating-point according to the current rounding direction. See <code>fenv.h</code> .
round	roundf	roundl	round	Returns the nearest integer value of x as <code>int</code> .
lround	lroundf	lroundl	lround	Returns the nearest integer value of x as <code>long int</code> .
llround	llroundf	llroundl	llround	Returns the nearest integer value of x as <code>long long int</code> .
trunc	truncf	truncl	trunc	Returns the truncated integer value x .

Remainder after division

math.h	tgmth.h			Description
fmod	fmodf	fmodl	fmod	Returns the remainder r of $x-ny$. n is chosen as <code>trunc(x/y)</code> . r has the same sign as x .
remainder	remainderf	remainderl	remainder	Returns the remainder r of $x-ny$. n is chosen as <code>trunc(x/y)</code> . r may not have the same sign as x .
remquo	remquof	remquol	remquo	Same as <code>remainder</code> . In addition, the argument <code>*quo</code> is given a specific value (see ISO).

Power and absolute-value functions

math.h		tgmath.h		Description
cbirt	cbirtf	cbirtl	cbirt	Returns the real cube root of x ($=x^{1/3}$).
fabs	fabsf	fabsl	fabs	Returns the absolute value of x ($ x $). (<code>abs</code> , <code>labs</code> , <code>llabs</code> , <code>div</code> , <code>ldiv</code> , <code>lldiv</code> are defined in <code>stdlib.h</code>)
fma	fmaf	fmal	fma	Floating-point multiply add. Returns $x*y+z$.
hypot	hypotf	hypotl	hypot	Returns the square root of x^2+y^2 .
pow	powf	powl	power	Returns x raised to the power y (x^y).
sqrt	sqrtf	sqrtl	sqrt	Returns the non-negative square root of x . $x \geq 0$.

Manipulation functions: `copysign`, `nan`, `nextafter`, `nexttoward`

math.h		tgmath.h		Description
<code>copysign</code>	<code>copysignf</code>	<code>copysignll</code>	<code>copysign</code>	Returns the value of x with the sign of y .
<code>nan</code>	<code>nanf</code>	<code>nanl</code>	-	Returns a quiet NaN, if available, with content indicated through <code>tagp</code> .
<code>nextafter</code>	<code>nextafterf</code>	<code>nextafterl</code>	<code>nextafter</code>	Returns the next representable value in the specified format after x in the direction of y . Returns y if $x=y$.
<code>nexttoward</code>	<code>nexttowardf</code>	<code>nexttowardl</code>	<code>nexttoward</code>	Same as <code>nextafter</code> , except that the second argument in all three variants is of type long double. Returns y if $x=y$.

Positive difference, maximum, minimum

math.h		tgmath.h		Description
<code>fdim</code>	<code>fdimf</code>	<code>fdiml</code>	<code>fdim</code>	Returns the positive difference between: $ x-y $.
<code>fmax</code>	<code>fmaxf</code>	<code>fmaxl</code>	<code>fmax</code>	Returns the maximum value of their arguments.
<code>fmin</code>	<code>fminf</code>	<code>fminl</code>	<code>fmin</code>	Returns the minimum value of their arguments.

Error and gamma

math.h		tgmath.h		Description
<code>erf</code>	<code>erff</code>	<code>erfl</code>	<code>erf</code>	Computes the error function of x .
<code>erfc</code>	<code>erfcf</code>	<code>erfcl</code>	<code>erfc</code>	Computes the complementary error function of x .
<code>lgamma</code>	<code>lgammaf</code>	<code>lgammal</code>	<code>lgamma</code>	Computes the $*\log_e \Gamma(x) $
<code>tgamma</code>	<code>tgammaf</code>	<code>tgammal</code>	<code>tgamma</code>	Computes $\Gamma(x)$

Comparison macros

The next are implemented as macros. For any ordered pair of numeric values exactly one of the relationships - *less*, *greater*, and *equal* - is true. These macros are type generic and therefore do not have a parallel function in `tgmath.h`. All arguments must be expressions of real-floating type.

math.h	tgmath.h	Description
<code>isgreater</code>	-	Returns the value of $(x) > (y)$
<code>isgreaterequal</code>	-	Returns the value of $(x) \geq (y)$
<code>isless</code>	-	Returns the value of $(x) < (y)$
<code>islessequal</code>	-	Returns the value of $(x) \leq (y)$
<code>islessgreater</code>	-	Returns the value of $(x) < (y) \ \ (x) > (y)$
<code>isunordered</code>	-	Returns 1 if its arguments are unordered, 0 otherwise.

Classification macros

The next are implemented as macros. These macros are type generic and therefore do not have a parallel function in `tgmath.h`. All arguments must be expressions of real-floating type.

math.h	tgmath.h	Description
<code>fpclassify</code>	-	Returns the class of its argument: FP_INFINITE, FP_NAN, FP_NORMAL, FP_SUBNORMAL or FP_ZERO
<code>isfinite</code>	-	Returns a nonzero value if and only if its argument has a finite value
<code>isinf</code>	-	Returns a nonzero value if and only if its argument has an infinite value
<code>isnan</code>	-	Returns a nonzero value if and only if its argument has NaN value.
<code>isnormal</code>	-	Returns a nonzero value if an only if its argument has a normal value.
<code>signbit</code>	-	Returns a nonzero value if and only if its argument value is negative.

14.2.17. setjmp.h

The `setjmp` and `longjmp` in this header file implement a primitive form of non-local jumps, which may be used to handle exceptional situations. This facility is traditionally considered more portable than `signal.h`

```
int setjmp(jmp_buf env)    Records its caller's environment in env and returns 0.

void longjmp(jmp_buf env, int status) Restores the environment previously saved with a call to setjmp().
```

14.2.18. signal.h

Signals are possible asynchronous events that may require special processing. Each signal is named by a number. The following signals are defined:

SIGINT	1	Receipt of an interactive attention signal
SIGILL	2	Detection of an invalid function message
SIGFPE	3	An erroneous arithmetic operation (for example, zero divide, overflow)
SIGSEGV	4	An invalid access to storage
SIGTERM	5	A termination request sent to the program
SIGABRT	6	Abnormal termination, such as is initiated by the <code>abort</code> function

The next function sends the signal *sig* to the program:

```
int raise(int sig)
```

The next function determines how subsequent signals will be handled:

```
signalfunction *signal (int, signalfunction *);
```

The first argument specifies the signal, the second argument points to the signal-handler function or has one of the following values:

SIG_DFL	Default behavior is used
SIG_IGN	The signal is ignored

The function returns the previous value of `signalfunction` for the specific signal, or `SIG_ERR` if an error occurs.

14.2.19. stdarg.h

The facilities in this header file gives you a portable way to access variable arguments lists, such as needed for `fprintf` and `vfprintf`. `va_copy` is new in ISO C99. This header file contains the following macros:

<code>va_arg(va_list ap, type)</code>	Returns the value of the next argument in the variable argument list. Its return type has the type of the given argument <code>type</code> . A next call to this macro will return the value of the next argument.
<code>va_copy(va_list dest, va_list src)</code>	This macro duplicates the current state of <code>src</code> in <code>dest</code> , creating a second pointer into the argument list. After this call, <code>va_arg()</code> may be used on <code>src</code> and <code>dest</code> independently.
<code>va_end(va_list ap)</code>	This macro must be called after the arguments have been processed. It should be called before the function using the macro 'va_start' is terminated.

`va_start(va_list ap, lastarg)` This macro initializes `ap`. After this call, each call to `va_arg()` will return the value of the next argument. In our implementation, `va_list` cannot contain any bit type variables. Also the given argument `lastarg` must be the last non-bit type argument in the list.

14.2.20. `stdbool.h`

This header file contains the following macro definitions. These names for boolean type and values are consistent with C++. You are allowed to `#undef` or `#define` the macros below.

```
#define bool          _Bool
#define true          1
#define false         0
#define __bool_true_false_are_defined 1
```

14.2.21. `stddef.h`

This header file defines the types for common use:

```
ptrdiff_t    Signed integer type of the result of subtracting two pointers.
size_t       Unsigned integral type of the result of the sizeof operator.
wchar_t      Integer type to represent character codes in large character sets.
```

Besides these types, the following macros are defined:

```
NULL         Expands to the null pointer constant for C or 0 (zero) for C++.
offsetof(_type, _member) Expands to an integer constant expression with type size_t that is the offset in bytes of _member within structure type _type.
```

14.2.22. `stdint.h`

See Section 14.2.10, [inttypes.h](#) and [stdint.h](#)

14.2.23. `stdio.h` and `wchar.h`

Types

The header file `stdio.h` contains functions for performing input and output. A number of functions also have a parallel wide character function or macro, defined in `wchar.h`. The header file `wchar.h` also includes `stdio.h`.

In the C language, many I/O facilities are based on the concept of streams. The `stdio.h` header file defines the data type `FILE` which holds the information about a stream. A `FILE` object is created with the function `fopen`. The pointer to this object is used as an argument in many of the in this header file. The `FILE` object can contain the following information:

- the current position within the stream

TASKING VX-toolset for ARM User Guide

- pointers to any associated buffers
- indications of for read/write errors
- end of file indication

The header file also defines type `fpos_t` as an unsigned `long`.

Macros

stdio.h	Description
<code>NULL</code>	Expands to the null pointer constant for C or 0 (zero) for C++.
<code>BUFSIZ</code>	Size of the buffer used by the <code>setbuf/setvbuf</code> function: 512
<code>EOF</code>	End of file indicator. Expands to -1.
<code>WEOF</code>	End of file indicator. Expands to <code>UINT_MAX</code> (defined in <code>limits.h</code>) NOTE: <code>WEOF</code> need not to be a negative number as long as its value does not correspond to a member of the wide character set. (Defined in <code>wchar.h</code>).
<code>FOPEN_MAX</code>	Number of files that can be opened simultaneously: 10
<code>FILENAME_MAX</code>	Maximum length of a filename: 100
<code>_IOFBF</code> <code>_IOLBF</code> <code>_IONBF</code>	Expand to an integer expression, suitable for use as argument to the <code>setvbuf</code> function.
<code>L_tmpnam</code>	Size of the string used to hold temporary file names: 8 (<code>tmpxxxxx</code>)
<code>TMP_MAX</code>	Maximum number of unique temporary filenames that can be generated: 0x8000
<code>SEEK_CUR</code> <code>SEEK_END</code> <code>SEEK_SET</code>	Expand to an integer expression, suitable for use as the third argument to the <code>fseek</code> function.
<code>stderr</code> <code>stdin</code> <code>stdout</code>	Expressions of type "pointer to FILE" that point to the FILE objects associated with standard error, input and output streams.

File access

stdio.h	Description
<code>fopen(name, mode)</code>	Opens a file for a given mode. Available modes are:

stdio.h	Description
"r"	read; open text file for reading
"w"	write; create text file for writing; if the file already exists, its contents is discarded
"a"	append; open existing text file or create new text file for writing at end of file
"r+"	open text file for update; reading and writing
"w+"	create text file for update; previous contents if any is discarded
"a+"	append; open or create text file for update, writes at end of file
	<i>(FSS implementation)</i>
<code>fclose(name)</code>	Flushes the data stream and closes the specified file that was previously opened with <code>fopen</code> . <i>(FSS implementation)</i>
<code>fflush(name)</code>	If stream is an output stream, any buffered but unwritten data is written. Else, the effect is undefined. <i>(FSS implementation)</i>
<code>freopen(name, mode, stream)</code>	Similar to <code>fopen</code> , but rather than generating a new value of type <code>FILE *</code> , the existing value is associated with a new stream. <i>(FSS implementation)</i>
<code>setbuf(stream, buffer)</code>	If <code>buffer</code> is <code>NULL</code> , buffering is turned off for the stream. Otherwise, <code>setbuf</code> is equivalent to: <code>(void) setvbuf(stream, buffer, _IOFBF, BUFSIZ)</code> .
<code>setvbuf(stream, buffer, mode, size)</code>	Controls buffering for the <code>stream</code> ; this function must be called before reading or writing. <code>Mode</code> can have the following values: <code>_IOFBF</code> causes full buffering <code>_IOLBF</code> causes line buffering of text files <code>_IONBF</code> causes no buffering. If <code>buffer</code> is not <code>NULL</code> , it will be used as a buffer; otherwise a buffer will be allocated. <code>size</code> determines the buffer size.

Formatted input/output

The `format` string of `printf` related functions can contain plain text mixed with conversion specifiers. Each conversion specifier should be preceded by a '%' character. The conversion specifier should be built in order:

- Flags (in any order):

- specifies left adjustment of the converted argument.

- + a number is always preceded with a sign character.
+ has higher precedence than `space`.

`space` a negative number is preceded with a sign, positive numbers with a space.

- 0 specifies padding to the field width with zeros (only for numbers).

- # specifies an alternate output form. For `o`, the first digit will be zero. For `x` or `X`, "0x" and "0X" will be prefixed to the number. For `e`, `E`, `f`, `g`, `G`, the output always contains a decimal point, trailing zeros are not removed.

TASKING VX-toolset for ARM User Guide

- A number specifying a minimum field width. The converted argument is printed in a field with at least the length specified here. If the converted argument has fewer characters than specified, it will be padded at the left side (or at the right when the flag '-' was specified) with spaces. Padding to numeric fields will be done with zeros when the flag '0' is also specified (only when padding left). Instead of a numeric value, also '*' may be specified, the value is then taken from the next argument, which is assumed to be of type `int`.
- A period. This separates the minimum field width from the precision.
- A number specifying the maximum length of a string to be printed. Or the number of digits printed after the decimal point (only for floating-point conversions). Or the minimum number of digits to be printed for an integer conversion. Instead of a numeric value, also '*' may be specified, the value is then taken from the next argument, which is assumed to be of type `int`.
- A length modifier 'h', 'hh', 'l', 'll', 'L', 'j', 'z' or 't'. 'h' indicates that the argument is to be treated as a `short` or `unsigned short`. 'hh' indicates that the argument is to be treated as a `char` or `unsigned char`. 'l' should be used if the argument is a `long` integer, 'll' for a `long long`. 'L' indicates that the argument is a `long double`. 'j' indicates a pointer to `intmax_t` or `uintmax_t`, 'z' indicates a pointer to `size_t` and 't' indicates a pointer to `ptrdiff_t`.

Flags, length specifier, period, precision and length modifier are optional, the conversion character is not. The conversion character must be one of the following, if a character following '%' is not in the list, the behavior is undefined:

Character Printed as	
d, i	<code>int</code> , signed decimal
o	<code>int</code> , unsigned octal
x, X	<code>int</code> , unsigned hexadecimal in lowercase or uppercase respectively
u	<code>int</code> , unsigned decimal
c	<code>int</code> , single character (converted to unsigned char)
s	<code>char *</code> , the characters from the string are printed until a NULL character is found. When the given precision is met before, printing will also stop
f, F	<code>double</code>
e, E	<code>double</code>
g, G	<code>double</code>
a, A	<code>double</code>
n	<code>int *</code> , the number of characters written so far is written into the argument. This should be a pointer to an integer in default memory. No value is printed.
p	pointer
%	No argument is converted, a '%' is printed.

printf conversion characters

All arguments to the `scanf` related functions should be pointers to variables (in default memory) of the type which is specified in the format string.

The format string can contain :

- Blanks or tabs, which are skipped.
- Normal characters (not '%'), which should be matched exactly in the input stream.
- Conversion specifications, starting with a '%' character.

Conversion specifications should be built as follows (in order) :

- A '*', meaning that no assignment is done for this field.
- A number specifying the maximum field width.
- The conversion characters `d`, `i`, `n`, `o`, `u` and `x` may be preceded by 'h' if the argument is a pointer to `short` rather than `int`, or by 'hh' if the argument is a pointer to `char`, or by 'l' (letter ell) if the argument is a pointer to `long` or by 'll' for a pointer to `long long`, 'j' for a pointer to `intmax_t` or `uintmax_t`, 'z' for a pointer to `size_t` or 't' for a pointer to `ptrdiff_t`. The conversion characters `e`, `f`, and `g` may be preceded by 'l' if the argument is a pointer to `double` rather than `float`, and by 'L' for a pointer to a `long double`.
- A conversion specifier. '*', maximum field width and length modifier are optional, the conversion character is not. The conversion character must be one of the following, if a character following '%' is not in the list, the behavior is undefined.

Length specifier and length modifier are optional, the conversion character is not. The conversion character must be one of the following, if a character following '%' is not in the list, the behavior is undefined.

Character Scanned as

d	int, signed decimal.
i	int, the integer may be given octal (i.e. a leading 0 is entered) or hexadecimal (leading "0x" or "0X"), or just decimal.
o	int, unsigned octal.
u	int, unsigned decimal.
x	int, unsigned hexadecimal in lowercase or uppercase.
c	single character (converted to unsigned char).
s	char *, a string of non white space characters. The argument should point to an array of characters, large enough to hold the string and a terminating NULL character.
f, F	float
e, E	float
g, G	float
a, A	float
n	int *, the number of characters written so far is written into the argument. No scanning is done.
p	pointer; hexadecimal value which must be entered without 0x- prefix.

Character Scanned as	
[...]	Matches a string of input characters from the set between the brackets. A NULL character is added to terminate the string. Specifying [...] includes the ']' character in the set of scanning characters.
[^...]	Matches a string of input characters not in the set between the brackets. A NULL character is added to terminate the string. Specifying [^...] includes the ']' character in the set.
%	Literal '%', no assignment is done.

scanf conversion characters

stdio.h	wchar.h	Description
<code>fscanf(stream, format, ...)</code>	<code>fwscanf(stream, format, ...)</code>	Performs a formatted read from the given <i>stream</i> . Returns the number of items converted successfully. (FSS implementation)
<code>scanf(format, ...)</code>	<code>wscanf(format, ...)</code>	Performs a formatted read from <code>stdin</code> . Returns the number of items converted successfully. (FSS implementation)
<code>sscanf(*s, format, ...)</code>	<code>swscanf(*s, format, ...)</code>	Performs a formatted read from the string <i>s</i> . Returns the number of items converted successfully.
<code>vfscanf(stream, format, arg)</code>	<code>vwscanf(stream, format, arg)</code>	Same as <code>fscanf/fwscanf</code> , but extra arguments are given as variable argument list <i>arg</i> . (See Section 14.2.19, stdarg.h)
<code>vscanf(format, arg)</code>	<code>vwscanf(format, arg)</code>	Same as <code>sscanf/swscanf</code> , but extra arguments are given as variable argument list <i>arg</i> . (See Section 14.2.19, stdarg.h)
<code>vsscanf(*s, format, arg)</code>	<code>vswscanf(*s, format, arg)</code>	Same as <code>scanf/wscanf</code> , but extra arguments are given as variable argument list <i>arg</i> . (See Section 14.2.19, stdarg.h)
<code>fprintf(stream, format, ...)</code>	<code>fwprintf(stream, format, ...)</code>	Performs a formatted write to the given <i>stream</i> . Returns EOF/WEOF on error. (FSS implementation)
<code>printf(format, ...)</code>	<code>wprintf(format, ...)</code>	Performs a formatted write to the stream <code>stdout</code> . Returns EOF/WEOF on error. (FSS implementation)
<code>sprintf(*s, format, ...)</code>	-	Performs a formatted write to string <i>s</i> . Returns EOF/WEOF on error.
<code>snprintf(*s, n, format, ...)</code>	<code>swprintf(*s, n, format, ...)</code>	Same as <code>sprintf</code> , but <i>n</i> specifies the maximum number of characters (including the terminating null character) to be written.
<code>vfprintf(stream, format, arg)</code>	<code>vwprintf(stream, format, arg)</code>	Same as <code>fprintf/fwprintf</code> , but extra arguments are given as variable argument list <i>arg</i> . (See Section 14.2.19, stdarg.h) (FSS implementation)

stdio.h	wchar.h	Description
<code>vprintf(format, arg)</code>	<code>wvprintf(format, arg)</code>	Same as <code>printf/wprintf</code> , but extra arguments are given as variable argument list <code>arg</code> . (See Section 14.2.19, <code>stdarg.h</code>) (FSS implementation)
<code>vsprintf(*s, format, arg)</code>	<code>wvsprintf(*s, format, arg)</code>	Same as <code>sprintf/swprintf</code> , but extra arguments are given as variable argument list <code>arg</code> . (See Section 14.2.19, <code>stdarg.h</code>)

The C library functions `printf()`, `fprintf()`, `vfprintf()`, `vsprintf()`, ... call one single function, `_doprint()`, that deals with the format string and arguments. The same applies to all `scanf` type functions, which call the function `_doscan()`, and also for the `wprintf` and `wscanf` type functions which call `_dowprint()` and `_dowscan()` respectively. The C library contains three versions of these routines: `int`, `long` and `long long` versions. If you use floating-point the formatter function for floating-point `_doflt()` or `_dowflt()` is called. Depending on the formatting arguments you use, the correct routine is used from the library. Of course the larger the version of the routine the larger your produced code will be.

Note that when you call any of the `printf/scanf` routines indirectly, the arguments are not known and always the `long long` version with floating-point support is used from the library.

Example:

```
#include <stdio.h>

long L;

void main(void)
{
    printf( "This is a long: %ld\n", L );
}
```

The linker extracts the `long` version without floating-point support from the library.

See also the description of `#pragma weak` in [Section 1.8, *Pragmas to Control the Compiler*](#).

Character input/output

stdio.h	wchar.h	Description
<code>fgetc(stream)</code>	<code>fgetwc(stream)</code>	Reads one character from <code>stream</code> . Returns the read character, or EOF/WEOF on error. (FSS implementation)
<code>getc(stream)</code>	<code>getwc(stream)</code>	Same as <code>fgetc/fgetwc</code> except that is implemented as a macro. (FSS implementation) NOTE: Currently #defined as <code>getchar()/getwchar()</code> because FILE I/O is not supported. Returns the read character, or EOF/WEOF on error.

stdio.h	wchar.h	Description
<code>getchar(stdin)</code>	<code>getwchar(stdin)</code>	Reads one character from the <code>stdin</code> stream. Returns the character read or EOF/WEOF on error. Implemented as macro. (FSS implementation)
<code>fgets(*s, n, stream)</code>	<code>fgetws(*s, n, stream)</code>	Reads at most the next $n-1$ characters from the <code>stream</code> into array <code>s</code> until a newline is found. Returns <code>s</code> or NULL or EOF/WEOF on error. (FSS implementation)
<code>gets(*s, n, stdin)</code>	-	Reads at most the next $n-1$ characters from the <code>stdin</code> stream into array <code>s</code> . A newline is ignored. Returns <code>s</code> or NULL or EOF/WEOF on error. (FSS implementation)
<code>ungetc(c, stream)</code>	<code>ungetwc(c, stream)</code>	Pushes character <code>c</code> back onto the input <code>stream</code> . Returns EOF/WEOF on error.
<code>fputc(c, stream)</code>	<code>fputwc(c, stream)</code>	Put character <code>c</code> onto the given <code>stream</code> . Returns EOF/WEOF on error. (FSS implementation)
<code>putc(c, stream)</code>	<code>putwc(c, stream)</code>	Same as <code>fputc/fputwc</code> except that is implemented as a macro. (FSS implementation)
<code>putchar(c, stdout)</code>	<code>putwchar(c, stdout)</code>	Put character <code>c</code> onto the <code>stdout</code> stream. Returns EOF/WEOF on error. Implemented as macro. (FSS implementation)
<code>fputs(*s, stream)</code>	<code>fputws(*s, stream)</code>	Writes string <code>s</code> to the given <code>stream</code> . Returns EOF/WEOF on error. (FSS implementation)
<code>puts(*s)</code>	-	Writes string <code>s</code> to the <code>stdout</code> stream. Returns EOF/WEOF on error. (FSS implementation)

Direct input/output

stdio.h	Description
<code>fread(ptr, size, nobj, stream)</code>	Reads <code>nobj</code> members of <code>size</code> bytes from the given <code>stream</code> into the array pointed to by <code>ptr</code> . Returns the number of elements successfully read. (FSS implementation)
<code>fwrite(ptr, size, nobj, stream)</code>	Writes <code>nobj</code> members of <code>size</code> bytes from to the array pointed to by <code>ptr</code> to the given <code>stream</code> . Returns the number of elements successfully written. (FSS implementation)

Random access

stdio.h	Description
<code>fseek(stream, offset, origin)</code>	Sets the position indicator for <code>stream</code> . (FSS implementation)

When repositioning a binary file, the new position `origin` is given by the following macros:

SEEK_SET 0 *offset* characters from the beginning of the file
 SEEK_CUR 1 *offset* characters from the current position in the file
 SEEK_END 2 *offset* characters from the end of the file

`ftell(stream)` Returns the current file position for *stream*, or -1L on error. (FSS implementation)

`rewind(stream)` Sets the file position indicator for the *stream* to the beginning of the file. This function is equivalent to:
`(void) fseek(stream, 0L, SEEK_SET);`
`clearerr(stream);`
 (FSS implementation)

`fgetpos(stream, pos)` Stores the current value of the file position indicator for *stream* in the object pointed to by *pos*. (FSS implementation)

`fsetpos(stream, pos)` Positions *stream* at the position recorded by `fgetpos` in **pos*. (FSS implementation)

Operations on files

stdio.h	Description
<code>remove(<i>file</i>)</code>	Removes the named file, so that a subsequent attempt to open it fails. Returns a non-zero value if not successful.
<code>rename(<i>old</i>, <i>new</i>)</code>	Changes the name of the file from old name to new name. Returns a non-zero value if not successful.
<code>tmpfile()</code>	Creates a temporary file of the mode "wb+" that will be automatically removed when closed or when the program terminates normally. Returns a <code>file</code> pointer.
<code>tmpnam(<i>buffer</i>)</code>	Creates new file names that do not conflict with other file names currently in use. The new file name is stored in a <i>buffer</i> which must have room for <code>L_tmpnam</code> characters. Returns a pointer to the temporary name. The file names are created in the current directory and all start with "tmp". At most <code>TMP_MAX</code> unique file names can be generated.

Error handling

stdio.h	Description
<code>clearerr(<i>stream</i>)</code>	Clears the end of file and error indicators for <i>stream</i> .
<code>ferror(<i>stream</i>)</code>	Returns a non-zero value if the error indicator for <i>stream</i> is set.
<code>feof(<i>stream</i>)</code>	Returns a non-zero value if the end of file indicator for <i>stream</i> is set.
<code>perror(<i>*s</i>)</code>	Prints <i>s</i> and the error message belonging to the integer <code>errno</code> . (See Section 14.2.5, <i>errno.h</i>)

14.2.24. `stdlib.h` and `wchar.h`

The header file `stdlib.h` contains general utility functions which fall into the following categories (Some have parallel wide-character, declared in `wchar.h`)

TASKING VX-toolset for ARM User Guide

- Numeric conversions
- Random number generation
- Memory management
- Environment communication
- Searching and sorting
- Integer arithmetic
- Multibyte/wide character and string conversions.

Macros

`EXIT_SUCCES` Predefined exit codes that can be used in the `exit` function.
0
`EXIT_FAILURE`
1
`RAND_MAX` Highest number that can be returned by the `rand/srand` function.
32767
`MB_CUR_MAX` 1 Maximum number of bytes in a multibyte character for the extended character set specified by the current locale (category `LC_CTYPE`, see [Section 14.2.14, *locale.h*](#)).

Numeric conversions

The following functions convert the initial portion of a string `*s` to a double, `int`, `long int` and `long long int` value respectively.

```
double    atof(*s)
int       atoi(*s)
long      atol(*s)
long long atoll(*s)
```

The following functions convert the initial portion of the string `*s` to a float, double and long double value respectively. `*endp` will point to the first character not used by the conversion.

stdlib.h		wchar.h	
float	<code>strtof(*s,**endp)</code>	float	<code>wcstof(*s,**endp)</code>
double	<code>strtod(*s,**endp)</code>	double	<code>wcstod(*s,**endp)</code>
long double	<code>strtold(*s,**endp)</code>	long double	<code>wcstold(*s,**endp)</code>

The following functions convert the initial portion of the string `*s` to a `long`, `long long`, unsigned `long` and unsigned `long long` respectively. Base specifies the radix. `*endp` will point to the first character not used by the conversion.

stdlib.h	wchar.h
long strtol (<i>*s</i> ,**endp,base)	long wcstol (<i>*s</i> ,**endp,base)
long long strtoll (<i>*s</i> ,**endp,base)	long long wcstoll (<i>*s</i> ,**endp,base)
unsigned long strtoul (<i>*s</i> ,**endp,base)	unsigned long wcstoul (<i>*s</i> ,**endp,base)
unsigned long long strtoull (<i>*s</i> ,**endp,base)	unsigned long long wcstoull (<i>*s</i> ,**endp,base)

Random number generation

`rand` Returns a pseudo random integer in the range 0 to `RAND_MAX`.
`srand(seed)` Same as `rand` but uses `seed` for a new sequence of pseudo random numbers.

Memory management

`malloc(size)` Allocates space for an object with size `size`.
The allocated space is not initialized. Returns a pointer to the allocated space.

`calloc(nobj,size)` Allocates space for `n` objects with size `size`.
The allocated space is initialized with zeros. Returns a pointer to the allocated space.

`free(*ptr)` Deallocates the memory space pointed to by `ptr` which should be a pointer earlier returned by the `malloc` or `calloc` function.

`realloc(*ptr,size)` Deallocates the old object pointed to by `ptr` and returns a pointer to a new object with size `size`, while preserving its contents.
If the new size is smaller than the old size, some contents at the end of the old region will be discarded. If the new size is larger than the old size, all of the old contents are preserved and any bytes in the new object beyond the size of the old object will have indeterminate values.

Environment communication

`abort()` Causes abnormal program termination. If the signal `SIGABRT` is caught, the signal handler may take over control. (See [Section 14.2.18, `signal.h`](#)).

`atexit(*func)` `func` points to a function that is called (without arguments) when the program normally terminates.

`exit(status)` Causes normal program termination. Acts as if `main()` returns with `status` as the return value. `Status` can also be specified with the predefined macros `EXIT_SUCCESS` or `EXIT_FAILURE`.

`_Exit(status)` Same as `exit`, but not registered by the `atexit` function or signal handlers registered by the `signal` function are called.

`getenv(*s)` Searches an environment list for a string `s`. Returns a pointer to the contents of `s`.
NOTE: this function is not implemented because there is no OS.

`system(*s)` Passes the string `s` to the environment for execution.
NOTE: this function is not implemented because there is no OS.

Searching and sorting

`bsearch(*key, *base, n, size, *cmp)` This function searches in an array of `n` members, for the object pointed to by `key`. The initial base of the array is given by `base`. The size of each member is specified by `size`. The given array must be sorted in ascending order, according to the results of the function pointed to by `cmp`. Returns a pointer to the matching member in the array, or NULL when not found.

`qsort(*base, n, size, *cmp)` This function sorts an array of `n` members using the quick sort algorithm. The initial base of the array is given by `base`. The size of each member is specified by `size`. The array is sorted in ascending order, according to the results of the function pointed to by `cmp`.

Integer arithmetic

`int abs(j)` Compute the absolute value of an `int`, `long int`, and `long long int j` respectively.
`long labs(j)`
`long long llabs(j)`

`div_t div(x,y)` Compute `x/y` and `x%y` in a single operation. `X` and `y` have respectively type `int`, `long int` and `long long int`. The result is stored in the members `quot` and `rem` of struct `div_t`, `ldiv_t` and `lldiv_t` which have the same types.
`ldiv_t ldiv(x,y)`
`lldiv_t lldiv(x,y)`

Multibyte/wide character and string conversions

`mblen(*s, n)` Determines the number of bytes in the multi-byte character pointed to by `s`. At most `n` characters will be examined. (See also `mbrlen` in [Section 14.2.28, `wchar.h`](#)).

`mbtowc(*pwc, *s, n)` Converts the multi-byte character in `s` to a wide-character code and stores it in `pwc`. At most `n` characters will be examined.

`wctomb(*s, wc)` Converts the wide-character `wc` into a multi-byte representation and stores it in the string pointed to by `s`. At most `MB_CUR_MAX` characters are stored.

`mbstowcs(*pwcs, *s, n)` Converts a sequence of multi-byte characters in the string pointed to by `s` into a sequence of wide characters and stores at most `n` wide characters into the array pointed to by `pwcs`. (See also `mbsrtowcs` in [Section 14.2.28, `wchar.h`](#)).

`wcstombs(*s, *pwcs, n)` Converts a sequence of wide characters in the array pointed to by `pwcs` into multi-byte characters and stores at most `n` multi-byte characters into the string pointed to by `s`. (See also `wcsrtowmb` in [Section 14.2.28, `wchar.h`](#)).

14.2.25. string.h and wchar.h

This header file provides numerous functions for manipulating strings. By convention, strings in C are arrays of characters with a terminating null character. Most functions therefore take arguments of type

*char. However, many functions have also parallel wide-character functions which take arguments of type `wchar_t`. These functions are declared in `wchar.h`.

Copying and concatenation functions

string.h	wchar.h	Description
<code>memcpy(*s1, *s2, n)</code>	<code>wmemcpy(*s1, *s2, n)</code>	Copies <i>n</i> characters from <i>*s2</i> into <i>*s1</i> and returns <i>*s1</i> . If <i>*s1</i> and <i>*s2</i> overlap the result is undefined.
<code>memmove(*s1, *s2, n)</code>	<code>wmemmove(*s1, *s2, n)</code>	Same as <code>memcpy</code> , but overlapping strings are handled correctly. Returns <i>*s1</i> .
<code>strcpy(*s1, *s2)</code>	<code>wscpy(*s1, *s2)</code>	Copies <i>*s2</i> into <i>*s1</i> and returns <i>*s1</i> . If <i>*s1</i> and <i>*s2</i> overlap the result is undefined.
<code>strncpy(*s1, *s2, n)</code>	<code>wcsncpy(*s1, *s2, n)</code>	Copies not more than <i>n</i> characters from <i>*s2</i> into <i>*s1</i> and returns <i>*s1</i> . If <i>*s1</i> and <i>*s2</i> overlap the result is undefined.
<code>strcat(*s1, *s2)</code>	<code>wscat(*s1, *s2)</code>	Appends a copy of <i>*s2</i> to <i>*s1</i> and returns <i>*s1</i> . If <i>*s1</i> and <i>*s2</i> overlap the result is undefined.
<code>strncat(*s1, *s2, n)</code>	<code>wcsncat(*s1, *s2, n)</code>	Appends not more than <i>n</i> characters from <i>*s2</i> to <i>*s1</i> and returns <i>*s1</i> . If <i>*s1</i> and <i>*s2</i> overlap the result is undefined.

Comparison functions

string.h	wchar.h	Description
<code>memcmp(*s1, *s2, n)</code>	<code>wmemcmp(*s1, *s2, n)</code>	Compares the first <i>n</i> characters of <i>*s1</i> to the first <i>n</i> characters of <i>*s2</i> . Returns < 0 if $*s1 < *s2$, 0 if $*s1 == *s2$, or > 0 if $*s1 > *s2$.
<code>strcmp(*s1, *s2)</code>	<code>wscmp(*s1, *s2)</code>	Compares string <i>*s1</i> to <i>*s2</i> . Returns < 0 if $*s1 < *s2$, 0 if $*s1 == *s2$, or > 0 if $*s1 > *s2$.
<code>strncmp(*s1, *s2, n)</code>	<code>wcsncmp(*s1, *s2, n)</code>	Compares the first <i>n</i> characters of <i>*s1</i> to the first <i>n</i> characters of <i>*s2</i> . Returns < 0 if $*s1 < *s2$, 0 if $*s1 == *s2$, or > 0 if $*s1 > *s2$.
<code>strcoll(*s1, *s2)</code>	<code>wscoll(*s1, *s2)</code>	Performs a local-specific comparison between string <i>*s1</i> and string <i>*s2</i> according to the <code>LC_COLLATE</code> category of the current locale. Returns < 0 if $*s1 < *s2$, 0 if $*s1 == *s2$, or > 0 if $*s1 > *s2$. (See Section 14.2.14, locale.h)
<code>strxfrm(*s1, *s2, n)</code>	<code>wcsxfrm(*s1, *s2, n)</code>	Transforms (a local) string <i>*s2</i> so that a comparison between transformed strings with <code>strcmp</code> gives the same result as a comparison between non-transformed strings with <code>strcoll</code> . Returns the transformed string <i>*s1</i> .

Search functions

string.h	wchar.h	Description
<code>memchr(*s, c, n)</code>	<code>wmemchr(*s, c, n)</code>	Checks the first <i>n</i> characters of <i>*s</i> on the occurrence of character <i>c</i> . Returns a pointer to the found character.

string.h	wchar.h	Description
<code>strchr(*s,c)</code>	<code>wcschr(*s,c)</code>	Returns a pointer to the first occurrence of character <i>c</i> in <i>*s</i> or the null pointer if not found.
<code>strrchr(*s,c)</code>	<code>wcsrchr(*s,c)</code>	Returns a pointer to the last occurrence of character <i>c</i> in <i>*s</i> or the null pointer if not found.
<code>strspn(*s,*set)</code>	<code>wcsspn(*s,*set)</code>	Searches <i>*s</i> for a sequence of characters specified in <i>*set</i> . Returns the length of the first sequence found.
<code>strcspn(*s,*set)</code>	<code>wcscspn(*s,*set)</code>	Searches <i>*s</i> for a sequence of characters <i>not</i> specified in <i>*set</i> . Returns the length of the first sequence found.
<code>strpbrk(*s,*set)</code>	<code>wcspbrk(*s,*set)</code>	Same as <code>strspn/wcsspn</code> but returns a pointer to the first character in <i>*s</i> that also is specified in <i>*set</i> .
<code>strstr(*s,*sub)</code>	<code>wcsstr(*s,*sub)</code>	Searches for a substring <i>*sub</i> in <i>*s</i> . Returns a pointer to the first occurrence of <i>*sub</i> in <i>*s</i> .
<code>strtok(*s,*dlm)</code>	<code>wcstok(*s,*dlm)</code>	A sequence of calls to this function breaks the string <i>*s</i> into a sequence of tokens delimited by a character specified in <i>*dlm</i> . The token found in <i>*s</i> is terminated with a null character. Returns a pointer to the first position in <i>*s</i> of the token.

Miscellaneous functions

string.h	wchar.h	Description
<code>memset(*s,c,n)</code>	<code>wmemset(*s,c,n)</code>	Fills the first <i>n</i> bytes of <i>*s</i> with character <i>c</i> and returns <i>*s</i> .
<code>strerror(errno)</code>	-	Typically, the values for <code>errno</code> come from <code>int errno</code> . This function returns a pointer to the associated error message. (See also Section 14.2.5, <i>errno.h</i>)
<code>strlen(*s)</code>	<code>wcslen(*s)</code>	Returns the length of string <i>*s</i> .

14.2.26. time.h and wchar.h

The header file `time.h` provides facilities to retrieve and use the (calendar) date and time, and the process time. Time can be represented as an integer value, or can be broken-down in components. Two arithmetic data types are defined which are capable of holding the integer representation of times:

```
clock_t unsigned long long
time_t unsigned long
```

The type `struct tm` below is defined according to ISO C99 with one exception: this implementation does not support leap seconds. The `struct tm` type is defined as follows:

```
struct tm
{
    int    tm_sec;        /* seconds after the minute - [0, 59]    */
    int    tm_min;        /* minutes after the hour - [0, 59]     */
    int    tm_hour;       /* hours since midnight - [0, 23]      */
    int    tm_mday;       /* day of the month - [1, 31]          */

```

```

int    tm_mon;        /* months since January - [0, 11]    */
int    tm_year;      /* year since 1900                    */
int    tm_wday;      /* days since Sunday - [0, 6]        */
int    tm_yday;      /* days since January 1 - [0, 365]   */
int    tm_isdst;     /* Daylight Saving Time flag         */
};

```

Time manipulation

`clock` Returns the application's best approximation to the processor time used by the program since it was started. This low-level routine is not implemented because it strongly depends on the hardware. To determine the time in seconds, the result of `clock` should be divided by the value defined by `CLOCKS_PER_SEC`.

`difftime(t1, t0)` Returns the difference $t1-t0$ in seconds.

`mktime(tm *tp)` Converts the broken-down time in the structure pointed to by *tp*, to a value of type `time_t`. The return value has the same encoding as the return value of the `time` function.

`time(*timer)` Returns the current calendar time. This value is also assigned to *timer*.

Time conversion

`asctime(tm *tp)` Converts the broken-down time in the structure pointed to by *tp* into a string in the form `Mon Jan 22 16:15:14 2007\n\0`. Returns a pointer to this string.

`ctime(*timer)` Converts the calendar time pointed to by *timer* to local time in the form of a string. This is equivalent to: `asctime(localtime(timer))`

`gmtime(*timer)` Converts the calendar time pointed to by *timer* to the broken-down time, expressed as UTC. Returns a pointer to the broken-down time.

`localtime(*timer)` Converts the calendar time pointed to by *timer* to the broken-down time, expressed as local time. Returns a pointer to the broken-down time.

Formatted time

The next function has a parallel function defined in `wchar.h`:

time.h	wchar.h
<code>strftime(*<i>s</i>, <i>smax</i>, *<i>fmt</i>, tm *<i>tp</i>)</code>	<code>wcsftime(*<i>s</i>, <i>smax</i>, *<i>fmt</i>, tm *<i>tp</i>)</code>

Formats date and time information from `struct tm *tp` into *s* according to the specified format *fmt*. No more than *smax* characters are placed into *s*. The formatting of `strftime` is locale-specific using the `LC_TIME` category (see [Section 14.2.14, locale.h](#)).

You can use the next conversion specifiers:

```

%a  abbreviated weekday name
%A  full weekday name
%b  abbreviated month name

```

TASKING VX-toolset for ARM User Guide

%B	full month name
%c	locale-specific date and time representation (same as %a %b %e %T %Y)
%C	last two digits of the year
%d	day of the month (01-31)
%D	same as %m/%d/%Y
%e	day of the month (1-31), with single digits preceded by a space
%F	ISO 8601 date format: %Y-%m-%d
%g	last two digits of the week based year (00-99)
%G	week based year (0000–9999)
%h	same as %b
%H	hour, 24-hour clock (00-23)
%I	hour, 12-hour clock (01-12)
%j	day of the year (001-366)
%m	month (01-12)
%M	minute (00-59)
%n	replaced by newline character
%p	locale's equivalent of AM or PM
%r	locale's 12-hour clock time; same as %I:%M:%S %p
%R	same as %H:%M
%S	second (00-59)
%t	replaced by horizontal tab character
%T	ISO 8601 time format: %H:%M:%S
%u	ISO 8601 weekday number (1-7), Monday as first day of the week
%U	week number of the year (00-53), week 1 has the first Sunday
%V	ISO 8601 week number (01-53) in the week-based year
%w	weekday (0-6, Sunday is 0)
%W	week number of the year (00-53), week 1 has the first Monday
%x	local date representation
%X	local time representation
%y	year without century (00-99)
%Y	year with century
%z	ISO 8601 offset of time zone from UTC, or nothing
%Z	time zone name, if any
%%	%

14.2.27. unistd.h

The file `unistd.h` contains standard UNIX I/O functions. These functions are all implemented using file system simulation. Except for `lstat` and `fstat` which are not implemented. This header file is not defined in ISO C99.

`access(*name, mode)` Use file system simulation to check the permissions of a file on the host. *mode* specifies the type of access and is a bit pattern constructed by a logical OR of the following values:

R_OK Checks read permission.
 W_OK Checks write permission.
 X_OK Checks execute (search) permission.
 F_OK Checks to see if the file exists.

(FSS implementation)

`chdir(*path)` Use file system simulation to change the current directory on the host to the directory indicated by *path*. *(FSS implementation)*

`close(fd)` File close function. The given file descriptor should be properly closed. This function calls `_close()`. *(FSS implementation)*

`getcwd(*buf, size)` Use file system simulation to retrieve the current directory on the host. Returns the directory name. *(FSS implementation)*

`lseek(fd, offset, whence)` Moves read-write file offset. Calls `_lseek()`. *(FSS implementation)*

`read(fd, *buff, cnt)` Reads a sequence of characters from a file. This function calls `_read()`. *(FSS implementation)*

`stat(*name, *buff)` Use file system simulation to `stat()` a file on the host platform. *(FSS implementation)*

`lstat(*name, *buff)` This function is identical to `stat()`, except in the case of a symbolic link, where the link itself is 'stat'-ed, not the file that it refers to. *(Not implemented)*

`fstat(fd, *buff)` This function is identical to `stat()`, except that it uses a file descriptor instead of a name. *(Not implemented)*

`unlink(*name)` Removes the named file, so that a subsequent attempt to open it fails. *(FSS implementation)*

`write(fd, *buff, cnt)` Write a sequence of characters to a file. Calls `_write()`. *(FSS implementation)*

14.2.28. wchar.h

Many functions in `wchar.h` represent the wide-character variant of other functions so these are discussed together. (See [Section 14.2.23, `stdio.h` and `wchar.h`](#), [Section 14.2.24, `stdlib.h` and `wchar.h`](#), [Section 14.2.25, `string.h` and `wchar.h`](#) and [Section 14.2.26, `time.h` and `wchar.h`](#)).

The remaining functions are described below. They perform conversions between multi-byte characters and wide characters. In these functions, *ps* points to `struct mbstate_t` which holds the conversion state information necessary to convert between sequences of multibyte characters and wide characters:

```
typedef struct
{
    wchar_t      wc_value; /* wide character value solved
                           so far */
    unsigned short n_bytes; /* number of bytes of solved
                           multibyte */
    unsigned short encoding; /* encoding rule for wide
                             character <=> multibyte
                             conversion */
} mbstate_t;
```

When multibyte characters larger than 1 byte are used, this struct will be used to store the conversion information when not all the bytes of a particular multibyte character have been read from the source. In this implementation, multi-byte characters are 1 byte long (MB_CUR_MAX and MB_LEN_MAX are defined as 1) and this will never occur.

<code>mbsinit(*ps)</code>	Determines whether the object pointed to by <i>ps</i> , is an initial conversion state. Returns a non-zero value if so.
<code>mbsrtowcs(*pwcs,**src,n,*ps)</code>	Restartable version of <code>mbstowcs</code> . See Section 14.2.24, <code>stdlib.h</code> and <code>wchar.h</code> . The initial conversion state is specified by <i>ps</i> . The input sequence of multibyte characters is specified indirectly by <i>src</i> .
<code>wcsrtombs(*s,**src,n,*ps)</code>	Restartable version of <code>wcstombs</code> . See Section 14.2.24, <code>stdlib.h</code> and <code>wchar.h</code> . The initial conversion state is specified by <i>ps</i> . The input wide string is specified indirectly by <i>src</i> .
<code>mbrtowc(*pwc,*s,n,*ps)</code>	Converts a multibyte character <i>*s</i> to a wide character <i>*pwc</i> according to conversion state <i>ps</i> . See also <code>mbtowc</code> in Section 14.2.24, <code>stdlib.h</code> and <code>wchar.h</code> .
<code>wcrtomb(*s,wc,*ps)</code>	Converts a wide character <i>wc</i> to a multi-byte character according to conversion state <i>ps</i> and stores the multi-byte character in <i>*s</i> .
<code>btowc(c)</code>	Returns the wide character corresponding to character <i>c</i> . Returns WEOF on error.
<code>wctob(c)</code>	Returns the multi-byte character corresponding to the wide character <i>c</i> . The returned multi-byte character is represented as one byte. Returns EOF on error.
<code>mbrlen(*s,n,*ps)</code>	Inspects up to <i>n</i> bytes from the string <i>*s</i> to see if those characters represent valid multibyte characters, relative to the conversion state held in <i>*ps</i> .

14.2.29. `wctype.h`

Most functions in `wctype.h` represent the wide-character variant of functions declared in `ctype.h` and are discussed in [Section 14.2.3, `ctype.h` and `wctype.h`](#). In addition, this header file provides extensible, locale specific functions and wide character classification.

`wctype(*property)` Constructs a value of type `wctype_t` that describes a class of wide characters identified by the string *property*. If *property* identifies a valid class of wide characters according to the `LC_TYPE` category (see [Section 14.2.14, *locale.h*](#)) of the current locale, a non-zero value is returned that can be used as an argument in the `iswctype` function.

`iswctype(wc, desc)` Tests whether the wide character *wc* is a member of the class represented by `wctype_t` *desc*. Returns a non-zero value if tested true.

Function	Equivalent to locale specific test
<code>iswalnum(wc)</code>	<code>iswctype(wc, wctype("alnum"))</code>
<code>iswalpha(wc)</code>	<code>iswctype(wc, wctype("alpha"))</code>
<code>iswcntrl(wc)</code>	<code>iswctype(wc, wctype("cntrl"))</code>
<code>iswdigit(wc)</code>	<code>iswctype(wc, wctype("digit"))</code>
<code>iswgraph(wc)</code>	<code>iswctype(wc, wctype("graph"))</code>
<code>iswlower(wc)</code>	<code>iswctype(wc, wctype("lower"))</code>
<code>iswprint(wc)</code>	<code>iswctype(wc, wctype("print"))</code>
<code>iswpunct(wc)</code>	<code>iswctype(wc, wctype("punct"))</code>
<code>iswspace(wc)</code>	<code>iswctype(wc, wctype("space"))</code>
<code>iswupper(wc)</code>	<code>iswctype(wc, wctype("upper"))</code>
<code>iswxdigit(wc)</code>	<code>iswctype(wc, wctype("xdigit"))</code>

`wctrans(*property)` Constructs a value of type `wctype_t` that describes a mapping between wide characters identified by the string *property*. If *property* identifies a valid mapping of wide characters according to the `LC_TYPE` category (see [Section 14.2.14, *locale.h*](#)) of the current locale, a non-zero value is returned that can be used as an argument in the `towctrans` function.

`towctrans(wc, desc)` Transforms wide character *wc* into another wide-character, described by *desc*.

Function	Equivalent to locale specific transformation
<code>towlower(wc)</code>	<code>towctrans(wc, wctrans("tolower"))</code>
<code>toupper(wc)</code>	<code>towctrans(wc, wctrans("toupper"))</code>

14.3. C Library Reentrancy

Some of the functions in the C library are reentrant, others are not. The table below shows the functions in the C library, and whether they are reentrant or not. A dash means that the function is reentrant. Note that some of the functions are not reentrant because they set the global variable 'errno' (or call other functions that eventually set 'errno'). If your program does not check this variable and `errno` is the only reason for the function not being reentrant, these functions can be assumed reentrant as well.

The explanation of the cause why a function is not reentrant sometimes refers to a footnote because the explanation is too lengthy for the table.

Function	Not reentrant because
<code>_close</code>	Uses global File System Simulation buffer, <code>_dbg_request</code>
<code>_doflt</code>	Uses I/O functions which modify <code>job[]</code> . See (1).
<code>_doprint</code>	Uses indirect access to static <code>job[]</code> array. See (1).
<code>_doscan</code>	Uses indirect access to <code>job[]</code> and calls <code>ungetc</code> (access to local static <code>ungetc[]</code> buffer). See (1).
<code>_Exit</code>	See <code>exit</code> .
<code>_filbuf</code>	Uses <code>job[]</code> , which is not reentrant. See (1).
<code>_flsbuf</code>	Uses <code>job[]</code> . See (1).
<code>_getflt</code>	Uses <code>job[]</code> . See (1).
<code>_job</code>	Defines static <code>job[]</code> . See (1).
<code>_lseek</code>	Uses global File System Simulation buffer, <code>_dbg_request</code>
<code>_open</code>	Uses global File System Simulation buffer, <code>_dbg_request</code>
<code>_read</code>	Uses global File System Simulation buffer, <code>_dbg_request</code>
<code>_unlink</code>	Uses global File System Simulation buffer, <code>_dbg_request</code>
<code>_write</code>	Uses global File System Simulation buffer, <code>_dbg_request</code>
<code>abort</code>	Calls <code>exit</code>
<code>abs labs llabs</code>	-
<code>access</code>	Uses global File System Simulation buffer, <code>_dbg_request</code>
<code>acos acosf acosl</code>	Sets <code>errno</code> .
<code>acosh acoshf acoshl</code>	Sets <code>errno</code> via calls to other functions.
<code>asctime</code>	<code>asctime</code> defines static array for broken-down time string.
<code>asin asinf asinl</code>	Sets <code>errno</code> .
<code>asinh asinhf asinhl</code>	Sets <code>errno</code> via calls to other functions.
<code>atan atanf atanl</code>	-
<code>atan2 atan2f atan2l</code>	-
<code>atanh atanhf atanh1</code>	Sets <code>errno</code> via calls to other functions.
<code>atexit</code>	<code>atexit</code> defines static array with function pointers to execute at exit of program.
<code>atof</code>	-
<code>atoi</code>	-
<code>atol</code>	-
<code>bsearch</code>	-
<code>btowc</code>	-
<code>cabs cabsf cabsl</code>	Sets <code>errno</code> via calls to other functions.
<code>cacos cacosf cacosl</code>	Sets <code>errno</code> via calls to other functions.
<code>cacosh cacosh cfacoshl</code>	Sets <code>errno</code> via calls to other functions.

Function	Not reentrant because
calloc	calloc uses static buffer management structures. See malloc (5).
carg cargf cargl	-
casin casinl	Sets errno via calls to other functions.
casinh casinh cfasinhl	Sets errno via calls to other functions.
catan catanf catanl	Sets errno via calls to other functions.
catanh catanhf catanh1	Sets errno via calls to other functions.
cbrt cbrtf cbrtl	-
ccos ccosf ccosl	Sets errno via calls to other functions.
ccosh ccoshf ccosh1	Sets errno via calls to other functions.
ceil ceilf ceill	-
cexp cexpf cexpl	Sets errno via calls to other functions.
chdir	Uses global File System Simulation buffer, <code>_dbg_request</code>
cimag cimagf cimagl	-
cleanup	Calls <code>fclose</code> . See (1)
clearerr	Modifies <code>job[]</code> . See (1)
clock	Uses global File System Simulation buffer, <code>_dbg_request</code>
clog clogf clogl	Sets errno via calls to other functions.
close	Calls <code>_close</code>
conj conjf conjl	-
copysign copysignf copysignl	-
cos cosf cosl	-
cosh coshf coshl	<code>cosh</code> calls <code>exp()</code> , which sets <code>errno</code> . If <code>errno</code> is discarded, <code>cosh</code> is reentrant.
cpow cpowf cpowl	Sets errno via calls to other functions.
cproj cprojf cprojl	-
creal crealf creall	-
csin csinf csinl	Sets errno via calls to other functions.
csinh csinhf csinhl	Sets errno via calls to other functions.
csqrt csqrtf csqrtl	Sets errno via calls to other functions.
ctan ctanf ctanl	Sets errno via calls to other functions.
ctanh ctanhf ctanh1	Sets errno via calls to other functions.
ctime	Calls <code>asctime</code>
difftime	-
div ldiv lldiv	-
erf erfl erff	-

Function	Not reentrant because
erfc erfcl erfcl	-
exit	Calls fclose indirectly which uses iob[] calls functions in _atexit array. See (1). To make exit reentrant kernel support is required.
exp expf expl	Sets errno.
exp2 exp2f exp2l	Sets errno.
expm1 expm1f expm1l	Sets errno via calls to other functions.
fabs fabsf fabsl	-
fclose	Uses values in iob[]. See (1).
fdim fdimf fdiml	-
feclearexcept	Writes PSW bits.
fegetenv	- (reads PSW bits)
fegetexceptflag	- (reads PSW bits via calls to other functions)
fegetround	- (reads PSW bits)
fehldexcept	Reads/writes PSW bits via calls to other functions.
feof	Uses values in iob[]. See (1).
feraiseexcept	Writes PSW bits.
ferror	Uses values in iob[]. See (1).
fesetenv	Writes PSW bits.
fesetexceptflag	Writes PSW bits via calls to other functions.
fesetround	Writes PSW bits.
fetestexcept	- (reads PSW bits)
feupdateenv	Writes PSW bits via calls to other functions.
fflush	Modifies iob[]. See (1).
fgetc fgetc	Uses pointer to iob[]. See (1).
fgetpos	Sets the variable errno and uses pointer to iob[]. See (1) / (2).
fgets fgets	Uses iob[]. See (1).
floor floorf floorl	-
fma fmaf fmal	-
fmax fmaxf fmaxl	-
fmin fminf fminl	-
fmod fmodf fmodl	-
fopen	Uses iob[] and calls malloc when file open for buffered IO. See (1)
fpclassify	-
fprintf fwprintf	Uses iob[]. See (1).
fputc fputc	Uses iob[]. See (1).

Function	Not reentrant because
fputs fputws	Uses iob[]. See (1).
fread	Calls fgetc. See (1).
free	free uses static buffer management structures. See malloc (5).
freopen	Modifies iob[]. See (1).
frexp frexpf frexpl	-
fscanf fwscanf	Uses iob[]. See (1)
fseek	Uses iob[] and calls _lseek. Accesses ungetc[] array. See (1).
fsetpos	Uses iob[] and sets errno. See (1) / (2).
fstat	<i>(Not implemented)</i>
ftell	Uses iob[] and sets errno. Calls _lseek. See (1) / (2).
fwrite	Uses iob[]. See (1).
getc getwc	Uses iob[]. See (1).
getchar getwchar	Uses iob[]. See (1).
getcwd	Uses global File System Simulation buffer, _dbg_request
getenv	Skeleton only.
gets getws	Uses iob[]. See (1).
gmtime	gmtime defines static structure
hypot hypotf hypotl	Sets errno via calls to other functions.
ilogb ilogbf ilogbl	Sets errno.
imaxabs	-
imaxdiv	-
isalnum iswalnum	-
isalpha iswalph	-
isascii iswascii	-
iscntrl iswcntrl	-
isdigit iswdigit	-
isfinite	-
isgraph iswgraph	-
isgreater	-
isgreaterequal	-
isinf	-
isless	-
islessequal	-
islessgreater	-
islower iswlower	-

Function	Not reentrant because
isnan	-
isnormal	-
isprint iswprint	-
ispunct iswpunct	-
isspace iswspace	-
isunordered	-
isupper iswupper	-
iswalnum	-
iswalpha	-
iswcntrl	-
iswctype	-
iswdigit	-
iswgraph	-
iswlower	-
iswprint	-
iswpunct	-
iswspace	-
iswupper	-
iswxdigit	-
isxdigit iswxdigit	-
ldexp ldexpf ldexpl	Sets errno. See (2).
lgamma lgammaf lgammal	Sets errno.
llrint llrintf llrintl	-
llround llroundf llroundl	Sets errno.
localeconv	N.A.; skeleton function
localtime	-
log logf logl	Sets errno. See (2).
log10 log10f log10l	Sets errno via calls to other functions.
loglp loglpf loglpl	Sets errno.
log2 log2f log2l	Sets errno.
logb logbf logbl	Sets errno.
longjmp	-
lrint lrintf lrintl	-
lround lroundf lroundl	Sets errno.
lseek	Calls _lseek

Function	Not reentrant because
lstat	<i>(Not implemented)</i>
malloc	Needs kernel support. See (5).
mblen	N.A., skeleton function
mbrlen	Sets errno.
mbrtowc	Sets errno.
mbsinit	-
mbsrtowcs	Sets errno.
mbstowcs	N.A., skeleton function
mbtowc	N.A., skeleton function
memchr wmemchr	-
memcmp wmemcmp	-
memcpy wmemcpy	-
memmove wmemmove	-
memset wmemset	-
mktime	-
modf modff modfl	-
nan nanf nanl	-
nearbyint nearbyintf nearbyintl	-
nextafter nextafterf nextafterl	-
nexttoward nexttowardf nexttowardl	-
offsetof	-
open	Calls <code>_open</code>
perror	Uses errno. See (2)
pow powf powl	Sets errno. See (2)
printf wprintf	Uses <code>iob[]</code> . See (1)
putc putwc	Uses <code>iob[]</code> . See (1)
putchar putwchar	Uses <code>iob[]</code> . See (1)
puts	Uses <code>iob[]</code> . See (1)
qsort	-
raise	Updates the signal handler table
rand	Uses static variable to remember latest random number. Must diverge from ISO C standard to define reentrant <code>rand</code> . See (4).
read	Calls <code>_read</code>

Function	Not reentrant because
realloc	See malloc (5).
remainder remainderf remainderl	-
remove	Uses global File System Simulation buffer, _dbg_request
remquo remquoof remquo1	-
rename	Uses global File System Simulation buffer, _dbg_request
rewind	Eventually calls _lseek
rint rintf rintl	-
round roundf roundl	-
scalbln scalblnf scalblnl	-
scalbn scalbnf scalbnl	-
scanf wscanf	Uses iob[], calls _doscan. See (1).
setbuf	Sets iob[]. See (1).
setjmp	-
setlocale	N.A.; skeleton function
setvbuf	Sets iob and calls malloc. See (1) / (5).
signal	Updates the signal handler table
signbit	-
sin sinf sinl	-
sinh sinhf sinh1	Sets errno via calls to other functions.
snprintf swprintf	Sets errno. See (2).
sprintf	Sets errno. See (2).
sqrt sqrtf sqrtl	Sets errno. See (2).
srand	See rand
sscanf swscanf	Sets errno via calls to other functions.
stat	Uses global File System Simulation buffer, _dbg_request
strcat wcscat	-
strchr wcschr	-
strcmp wcscmp	-
strcoll wcscoll	-
strcpy wcsncpy	-
strcspn wcsncpy	-
strerror	-
strftime wcsftime	-
strlen wcslen	-

Function	Not reentrant because
strncat wcsncat	-
strncmp wcsncmp	-
strncpy wcsncpy	-
strpbrk wcpbrk	-
strchr wcschr	-
strspn wcsspn	-
strstr wcsstr	-
strtod wctod	-
strtof wctof	-
strtoimax	Sets errno via calls to other functions.
strtok wctok	strtok saves last position in string in local static variable. This function is not reentrant by design. See (4).
strtol wcstol	Sets errno. See (2).
strtold wcstold	-
strtoul wcstoul	Sets errno. See (2).
strtoull wcstoull	Sets errno. See (2).
strtoumax	Sets errno via calls to other functions.
strxfrm wcsxfrm	-
system	N.A.; skeleton function
tan tanf tanl	Sets errno. See (2).
tanh tanhf tanhl	Sets errno via call to other functions.
tgamma tgammaf tgamma1	Sets errno.
time	Uses static variable which defines initial start time
tmpfile	Uses iob[]. See (1).
tmpnam	Uses local buffer to build filename. Function can be adapted to use user buffer. This makes the function non ISO C. See (4).
toascii	-
tolower	-
toupper	-
towctrans	-
tolower	-
toupper	-
trunc truncf trunc1	-
ungetc ungetc	Uses static buffer to hold ungetc characters for each file. Can be moved into iob structure. See (1).

Function	Not reentrant because
<code>unlink</code>	Uses global File System Simulation buffer, <code>_dbg_request</code>
<code>vfprintf</code> <code>vwprintf</code>	Uses <code>job[]</code> . See (1).
<code>vfscanf</code> <code>vwscanf</code>	Calls <code>_doscan</code>
<code>vprintf</code> <code>vwprintf</code>	Uses <code>job[]</code> . See (1).
<code>vscanf</code> <code>vwscanf</code>	Calls <code>_doscan</code>
<code>vsprintf</code> <code>vswprintf</code>	Sets <code>errno</code> .
<code>vsscanf</code> <code>vswscanf</code>	Sets <code>errno</code> .
<code>wcrtomb</code>	Sets <code>errno</code> .
<code>wcsrtombs</code>	Sets <code>errno</code> .
<code>wcstoimax</code>	Sets <code>errno</code> via calls to other functions.
<code>wcstombs</code>	N.A.; skeleton function
<code>wcstoumax</code>	Sets <code>errno</code> via calls to other functions.
<code>wctob</code>	-
<code>wctomb</code>	N.A.; skeleton function
<code>wctrans</code>	-
<code>wctype</code>	-
<code>write</code>	Calls <code>_write</code>

Table: C library reentrancy

Several functions in the C library are not reentrant due to the following reasons:

- The `job[]` structure is static. This influences all I/O functions.
- The `ungetc[]` array is static. This array holds the characters (one for each stream) when `ungetc()` is called.
- The variable `errno` is globally defined. Numerous functions read or modify `errno`
- `_doprint` and `_doscan` use static variables for e.g. character counting in strings.
- Some string functions use locally defined (static) buffers. This is prescribed by ANSI.
- `malloc` uses a static heap space.

The following description discusses these items in more detail. The numbers at the beginning of each paragraph relate to the number references in the table above.

(1) *job structures*

The I/O part of the C library is not reentrant by design. This is mainly caused by the static declaration of the `job[]` array. The functions which use elements of this array access these elements via pointers (`FILE *`).

Building a multi-process system that is created in one link-run is hard to do. The C language scoping rules for external variables make it difficult to create a private copy of the `iob[]` array. Currently, the `iob[]` array has external scope. Thus it is visible in every module involved in one link phase. If these modules comprise several tasks (processes) in a system each of which should have its private copy of `iob[]`, it is apparent that the `iob[]` declaration should be changed. This requires adaptation of the library to the multi-tasking environment. The library modules must use a process identification as an index for determining which `iob[]` array to use. Thus the library is suitable for interfacing to that kernel only.

Another approach for the `iob[]` declaration problem is to declare the array static in one of the modules which create a task. Thus there can be more than one `iob[]` array in the system without having conflicts at link time. This brings several restrictions: Only the module that holds the declaration of the static `iob[]` can use the standard file handles `stdin`, `stdout` and `stderr` (which are the first three entries in `iob[]`). Thus all I/O for these three file handles should be located in one module.

(2) *errno* declaration

Several functions in the C library set the global variable `errno`. After completion of the function the user program may consult this variable to see if some error occurred. Since most of the functions that set `errno` already have a return type (this is the reason for using `errno`) it is not possible to check successful completion via the return type.

The library routines can set `errno` to the values defined in `errno.h`. See the file `errno.h` for more information.

`errno` can be set to `ERR_FORMAT` by the print and scan functions in the C library if you specify illegal format strings.

`errno` will never be set to `ERR_NOLONG` or `ERR_NOPOINT` since the C library supports long and pointer conversion routines for input and output.

`errno` can be set to `ERANGE` by the following functions: `exp()`, `strtol()`, `strtoul()` and `tan()`. These functions may produce results that are out of the valid range for the return type. If so, the result of the function will be the largest representable value for that type and `errno` is set to `ERANGE`.

`errno` is set to `EDOM` by the following functions: `acos()`, `asin()`, `log()`, `pow()` and `sqrt()`. If the arguments for these functions are out of their valid range (e.g. `sqrt(-1)`), `errno` is set to `EDOM`.

`errno` can be set to `ERR_POS` by the file positioning functions `ftell()`, `fsetpos()` and `fgetpos()`.

(3) *ungetc*

Currently the `ungetc` buffer is static. For each file entry in the `iob[]` structure array, there is one character available in the buffer to `ungetc` a character.

(4) *local buffers*

`tmpnam()` creates a temporary filename and returns a pointer to a local static buffer. This is according to the ANSI definition. Changing this function such that it creates the name in a user specified buffer requires another calling interface. Thus the function would be no longer portable.

TASKING VX-toolset for ARM User Guide

`strtok()` scans through a string and remembers that the string and the position in the string for subsequent calls. This function is not reentrant by design. Making it reentrant requires support of a kernel to store the information on a per process basis.

`rand()` generates a sequence of random numbers. The function uses the value returned by a previous call to generate the next value in the sequence. This function can be made reentrant by specifying the previous random value as one of the arguments. However, then it is no longer a standard function.

(5) *malloc*

Malloc uses a heap space which is assigned at locate time. Thus this implementation is not reentrant. Making a reentrant malloc requires some sort of system call to obtain free memory space on a per process basis. This is not easy to solve within the current context of the library. This requires adaptation to a kernel.

This paragraph on reentrancy applies to multi-process environments only. If reentrancy is required for calling library functions from an exception handler, another approach is required. For such a situation it is of no use to allocate e.g. multiple `ioB[]` structures. In such a situation several pieces of code in the library have to be declared 'atomic': this means that interrupts have to be disabled while executing an atomic piece of code.

Chapter 15. List File Formats

This chapter describes the format of the assembler list file and the linker map file.

15.1. Assembler List File Format

The assembler list file is an additional output file of the assembler that contains information about the generated code. For details on how to generate a list file, see [Section 6.5, *Generating a List File*](#).

The list file consists of a page header and a source listing.

Page header

The page header is repeated on every page:

```
TASKING VX-toolset for ARM: assembler vx.yrz Build nnn SN 00000000
Title                                                    Page 1
```

```
ADDR CODE          CYCLES  LINE SOURCE LINE
```

The first line contains version information. The second line can contain a title which you can specify with the assembler directive `.TITLE` and always contains a page number. The third line is empty and the fourth line contains the headings of the columns for the source listing.

With the assembler directives `.LIST/.NOLIST`, `.PAGE`, and with the [assembler option `--list-format`](#) you can format the list file.

Source listing

The following is a sample part of a listing. An explanation of the different columns follows below.

```
ADDR CODE          CYCLES  LINE SOURCE LINE
                                1           ; Module start
                                .
                                .
0000 08009FE5      1     1    16         ldr     r0, .L2
0004 001090E5      1     2    17         ldr     r1, [r0, #0]
0008 04009FE5      1     3    18         ldr     r0, .L2+4
000C rrrrrrEA      3     6    19         b       printf
                                .
                                .
0000                                38         .ds     2
  | RESERVED
0001
```

TASKING VX-toolset for ARM User Guide

ADDR	This column contains the memory address. The address is a hexadecimal number that represents the offset from the beginning of a relocatable section or the absolute address for an absolute section. The address only appears on lines that generate object code.
CODE	This is the object code generated by the assembler for this source line, displayed in hexadecimal format. The displayed code need not be the same as the generated code that is entered in the object module. The code can also be relocatable code. In this case the letter 'r' is printed for the relocatable code part in the listing. For lines that allocate space, the code field contains the text "RESERVED". For lines that initialize a buffer, the code field lists one value followed by the word "REPEATS".
CYCLES	The first number in this column is the number of instruction cycles needed to execute the instruction(s) as generated in the CODE field. The second number is the accumulated cycle count of this section.
LINE	This column contains the line number. This is a decimal number indicating each input line, starting from 1 and incrementing with each source line.
SOURCE LINE	This column contains the source text. This is a copy of the source line from the assembly source file.

For the `.SET` and `.EQU` directives the ADDR and CODE columns do not apply. The symbol value is listed instead.

15.2. Linker Map File Format

The linker map file is an additional output file of the linker that shows how the linker has mapped the sections and symbols from the various object files (`.obj`) to output sections. The locate part shows the absolute position of each section. External symbols are listed per space with their absolute address, both sorted on symbol and sorted on address. For details on how to generate a map file, see [Section 7.9, Generating a Map File](#).

With the linker option `--map-file-format` you can specify which parts of the map file you want to see.

In Eclipse the linker map file (`project.map.xml`) is generated in the output directory of the build configuration, usually `Debug` or `Release`. You can open the map file by double-clicking on the file name.

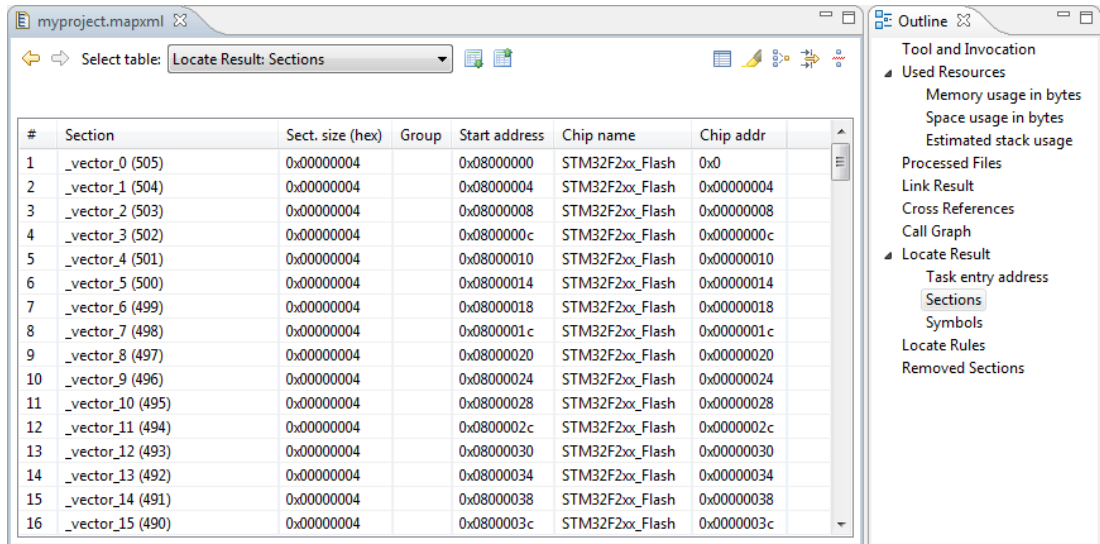

Each page displays a part of the map file. You can use the drop-down list or the Outline view to navigate through the different tables and you can use the following buttons.

Icon	Action	Description
	Back	Goes back one page in the history list.
	Forward	Goes forward one page in the history list.
	Next Table	Shows the next table from the drop-down list.
	Previous Table	Shows the previous table from the drop-down list.

When you right-click in the view, a popup menu appears (for example, to reset the layout of a table). The meaning of the different parts is:

Tool and Invocation

This part of the map file contains information about the linker, its version header information, binary location and which options are used to call it.

Used Resources

This part of the map file shows the memory usage at memory level and space level. The largest free block of memory (*Largest gap*) is also shown. This part also contains an estimation of the stack usage.

Explanation of the columns:

Memory

The names of the system memory and user memory as defined in the linker script file (*.isl).

TASKING VX-toolset for ARM User Guide

Code	The size of all executable sections.
Data	The size of all non-executable sections (not including stacks, heaps, debug sections in non-alloc space).
Reserved	The total size of reserved memories, reserved ranges, reserved special sections, stacks, heaps, alignment protections, sections located in non-alloc space (debug sections). In fact, this size is the same as the size in the Total column minus the size of all other columns.
Free	The free memory area addressable by this core. This area is accessible for unrestricted items.
Total	The total memory area addressable by this core.
Space	The names of the address spaces as defined in the linker script file (* .lsl). The names are constructed of the <code>derivative</code> name followed by a colon ':', the <code>core</code> name, another colon ':' and the <code>space</code> name. For example: <code>ARM:ARM:linear</code> .
Native used ...	The size of sections located in this space.
Foreign used	The size of all sections destined for/located in other spaces, but because of overlap in spaces consume memory in this space.
Stack Name	The name(s) of the stack(s) as defined in the linker script file (* .lsl).
Used	An estimation of the stack usage. The linker calculates the required stack size by using information (.CALLS directives) generated by the compiler. If for example recursion is detected, the calculated stack size is inaccurate, therefore this is an estimation only. The calculated stack size is supposed to be smaller than the actual allocated stack size. If that is not the case, then a warning is given.

Processed Files

This part of the map file shows all processed files. This also includes object files that are extracted from a library, with the symbol that led to the extraction.

Link Result

This part of the map file shows per object file how the link phase has mapped the sections from the various object files (.obj) to output sections.

[in] File	The name of an input object file.
[in] Section	A section name and id from the input object file. The number between '(' ')' uniquely identifies the section.
[in] Size	The size of the input section.
[out] Offset	The offset relative to the start of the output section.
[out] Section	The resulting output section name and id.
[out] Size	The size of the output section.

Module Local Symbols

This part of the map file shows a table for each local scope within an object file. Each table has three columns, 1 the symbol name, 2 the address of the symbol and 3 the space where the symbol resides in. The table is sorted on symbol name within each space.



By default this part is not shown in the map file. You have to turn this part on manually with linker option `--map-file-format=+statics` (module local symbols).





Cross References

This part of the map file lists all symbols defined in the object modules and for each symbol the object modules that contain a reference to the symbol are shown. Also, symbols that remain undefined are shown.

Call Graph

This part of the map file contains a schematic overview that shows how (library) functions call each other. To obtain call graph information, the assembly file must contain `.CALLS` directives.

You can click the + or - sign to expand or collapse a single node. Use the  /  buttons to expand/collapse all nodes in the call graph.

Icon	Meaning	Description
	Root	This function is the top of the call graph. If there are interrupt handlers, there can be several roots.
	Callee	This function is referenced by several No leaf functions. Right-click on the function and select Expand all References to see all functions that reference this function. Select Back to Caller to return to the calling function.
	Node	A normal node (function) in the call graph.
	Caller	This function calls a function which is listed separately in the call graph. Right-click on the function and select Go to Callee to see the callee. Hover the mouse over the function to see a popup with all callees.

Overlay





This part is empty for the ARM.

Locate Result: Sections

This part of the map file shows the absolute position of each section in the absolute object file. It is organized per memory chip and group and sorted on space address. In Eclipse, right-click in the table and select **Configure Columns** to specify which columns you want to see. If you hover the mouse over a section, you get a popup with information about the section. If you select a range of sections, in the Fast View bar (at the bottom) you will see information about the selected range, such as the total size, how many sections are selected and how many gaps are present.

#	The line number and default sort order.
Section	The name and id of the section. The number between '(')' uniquely identifies the section. Sections within square brackets [] will be copied during initialization from ROM to the corresponding section name in RAM.
Section name	
Section number	
Sect. size (hex)	The size of the section in minimum addressable units (hexadecimal or decimal).
Sect. size (dec)	
Group	Sections can be ordered in groups. These are the names of the groups as defined in the linker script file (* .lsl) with the keyword <code>group</code> in the <code>section_layout</code> definition. The name that is displayed is the name of the deepest nested group.
Start address	The first address of the section in the address space.
End address	The last address of the section in the address space.
Symbols in sect.	The names of the external symbols that are referenced in the section. See Locate Result: Symbols below.
Defined in	The names of the input modules the section is defined in. See Link Result: [in] File above.
Referenced in	The names of the modules that contain a reference to the section. See Cross References above.
Address space	The name of the address space.
Chip name	The names of the memory chips as defined in the linker script file (* .lsl) in the <code>memory</code> definitions.
Chip addr	The absolute offset of the section from the start of a memory chip.
Locate type:properties	The locate rule type and properties. See Locate Rules below.

The following buttons are available in this part of the map file.

Icon	Action	Description
	Configure Section Filter	Opens the Configure Section Filter dialog. Here you can select which sections you want to see in the map file and how.
	Enable Highlighting	All sections that are marked with "Highlight" in the Configure Section Filter dialog will be highlighted in the table.
	Enable Collapsing	All sections that are marked with "Collapse" in the Configure Section Filter dialog will appear collapsed in the table.
	Only Show Matching Lines	All lines that are not part of the selection in the Configure Section Filter dialog will be hidden.
	Show Gaps	Also shows the gaps in the map file. Click the button again to hide the gaps.

Configure Section Filter Dialog

In this dialog you can filter which sections you want to see in the map file and how. Click **Add** to add a new filter. Explanation of the columns and fields:

Highlight	Marks the section as a candidate for highlighting. Turn on Enable Highlighting to see the effect.
Color	The highlight color.
Collapse	Marks the section as a candidate for collapsing. Turn on Enable Collapsing to see the effect.
Section name	A filter to select a section or group of sections. Wildcards are allowed. Wildcards follow the rules of regular expressions. To get help on which wildcards are supported, press Ctrl-space . Click an item in the list for help, double-click to add the wildcard.
Start address	The first address of the section in the address space for this filter.
End address	The last address of the section in the address space for this filter.
Address space	The name of the address space.
Chip name	The name of the memory chip as defined in the linker script file (*.lsl) in the memory definitions.
Hide gaps smaller than	If gaps are shown in the map file, here you can limit the number of gaps you want to see.

The meaning of the check boxes is the same as the corresponding buttons available in this part of the map file.

Locate Result: Symbols

This part of the map file lists all external symbols per address space name.

Address	The absolute address of the symbol in the address space.
Name	The name of the symbol.
Space	The names of the address spaces as defined in the linker script file (*.lsl). The names are constructed of the <i>derivative</i> name followed by a colon ':', the <i>core</i> name, another colon ':' and the <i>space</i> name. For example: ARM:ARM:linear.

Processor and Memory

This part of the map file shows the processor and memory information of the linker script file.

By default this part is not shown in the map file. You have to turn this part on manually with linker option **--map-file-format=+lsl** (processor and memory info). You can print this information to a separate file with linker option **--lsl-dump**.

You can click the + or - sign to expand or collapse a part of the information.

Locate Rules

This part of the map file shows the rules the linker uses to locate sections.

TASKING VX-toolset for ARM User Guide

Address space	The names of the address spaces as defined in the linker script file (*.lsl). The names are constructed of the <code>derivative</code> name followed by a colon ':', the <code>core</code> name, another colon ':' and the <code>space</code> name.
Type	<p>The rule type:</p> <pre>ordered/contiguous/clustered/unrestricted</pre> <p>Specifies how sections are grouped. By default, a group is 'unrestricted' which means that the linker has total freedom to place the sections of the group in the address space.</p> <pre>absolute</pre> <p>The section must be located at the address shown in the Properties column.</p> <pre>ranged</pre> <p>The section must be located anywhere in the address ranges shown in the Properties column; end addresses are not included in the range.</p> <pre>page</pre> <p>The sections must be located in some address range with a size not larger than shown in the Properties column; the first number is the page size, the second part is the address range restriction within the page.</p> <pre>ranged page</pre> <p>Both the ranged and the paged restriction apply. In the Properties column the range restriction is listed first, followed by the paged restriction between parenthesis.</p> <pre>ballooned</pre> <p>After locating all sections, the largest remaining gap in the space is used completely for the stack and/or heap.</p>
Properties	The contents depends on the Type column.
Prio	The locate priority of the rule. A higher priority value gives a rule precedence over a rule with a lower priority, but only if the two rules have the same type and the same properties. The relative order of rules of different types or different properties is not affected by this priority value. You can set the priority with the priority group attribute in LSL
Sections	<p>The sections to which the rule applies;</p> <p>restrictions between sections are shown in this column:</p> <pre>< ordered contiguous + clustered</pre> <p>For contiguous sections, the linker uses the section order as shown here. Clustered sections can be located in any relative order.</p>

Removed Sections

This part of the map file shows the sections which are removed from the output file as a result of the optimization option to delete unreferenced sections and or duplicate code or constant data ([linker option --optimize=cxy](#)).

Section	The name of the section which has been removed.
File	The name of the input object file where the section is removed from.
Library	The name of the library where the object file is part of.
Symbol	The symbols that were present in the section.
Reason	The reason why the section has been removed. This can be because the section is unreferenced or duplicated.

Chapter 16. Object File Formats

This chapter describes the format of several object files.

16.1. ELF/DWARF Object Format

The TASKING VX-toolset for ARM by default produces objects in the ELF/DWARF 3 format.

For a complete description of the ELF format, please refer to the *Tool Interface Standard (TIS)*.

For a complete description of the DWARF format, please refer to the *DWARF Debugging Information Format Version 3*. See <http://dwarfstd.org/>

16.2. Intel Hex Record Format

Intel Hex records describe the hexadecimal object file format for 8-bit, 16-bit and 32-bit microprocessors. The hexadecimal object file is an ASCII representation of an absolute binary object file. There are six different types of records:

- Data Record (8-, 16, or 32-bit formats)
- End of File Record (8-, 16, or 32-bit formats)
- Extended Segment Address Record (16, or 32-bit formats)
- Start Segment Address Record (16, or 32-bit formats)
- Extended Linear Address Record (32-bit format only)
- Start Linear Address Record (32-bit format only)

To generate an Intel Hex output file:

1. From the **Project** menu, select **Properties for**
The Properties dialog appears.
2. In the left pane, expand **C/C++ Build** and select **Settings**.
In the right pane the Settings appear.
3. On the Tool Settings tab, select **Linker » Output Format**.
4. Enable the option **Generate Intel Hex format file**.
5. (Optional) Specify the **Size of addresses (in bytes) for Intel Hex records**.
6. (Optional) Enable or disable the option **Emit start address record**.

By default the linker generates records in the 32-bit format (4-byte addresses).

General Record Format

In the output file, the record format is:

:	<i>length</i>	<i>offset</i>	<i>type</i>	<i>content</i>	<i>checksum</i>
---	---------------	---------------	-------------	----------------	-----------------

where:

: is the record header.

length is the record length which specifies the number of bytes of the *content* field. This value occupies one byte (two hexadecimal digits). The linker outputs records of 255 bytes (32 hexadecimal digits) or less; that is, *length* is never greater than 0xFF.

offset is the starting load offset specifying an absolute address in memory where the data is to be located when loaded by a tool. This field is two bytes long. This field is only used for Data Records. In other records this field is coded as four ASCII zero characters ('0000').

type is the record type. This value occupies one byte (two hexadecimal digits). The record types are:

Byte Type	Record Type
00	Data
01	End of file
02	Extended segment address (not used)
03	Start segment address (not used)
04	Extended linear address (32-bit)
05	Start linear address (32-bit)

content is the information contained in the record. This depends on the record type.

checksum is the record checksum. The linker computes the checksum by first adding the binary representation of the previous bytes (from *length* to *content*). The linker then computes the result of sum modulo 256 and subtracts the remainder from 256 (two's complement). Therefore, the sum of all bytes following the header is zero.

Start Linear Address Record

The Start Linear Address Record contains the 32-bit program execution start address.

:	04	0000	05	address	checksum
---	----	------	----	---------	----------

With linker option **--hex-format=S** you can prevent the linker from emitting this record.

Example:

```
:0400000500FF0003F5
| | | | | _ checksum
| | | | | _ address
| | | | | _ type
| | _ offset
| _ length
```

End of File Record

The hexadecimal file always ends with the following end-of-file record:

```
:00000001FF
| | | | | _ checksum
| | | | | _ type
| | _ offset
| _ length
```

16.3. Motorola S-Record Format

To generate a Motorola S-record output file:

1. From the **Project** menu, select **Properties for**
The Properties dialog appears.
2. In the left pane, expand **C/C++ Build** and select **Settings**.
In the right pane the Settings appear.
3. On the Tool Settings tab, select **Linker » Output Format**.
4. Enable the option **Generate S-records file**.
5. (Optional) Specify the **Size of addresses (in bytes) for Motorola S records**.

By default, the linker produces output in Motorola S-record format with three types of S-records (4-byte addresses): S0, S3 and S7. Depending on the size of addresses you can force other types of S-records. They have the following layout:

S0 - record

S0	<i>length</i>	0000	<i>comment</i>	<i>checksum</i>
-----------	---------------	------	----------------	-----------------

A linker generated S-record file starts with an S0 record with the following contents:

```
l k a r m
S00800006C6B61726DE0
```

The S0 record is a comment record and does not contain relevant information for program execution.

where:

S0	is a comment record and does not contain relevant information for program execution.
<i>length</i>	represents the number of bytes in the record, not including the record type and length byte. This value occupies one byte (two hexadecimal digits).
<i>comment</i>	contains the name of the linker.
<i>checksum</i>	is the record checksum. The linker computes the checksum by first adding the binary representation of the bytes following the record type (starting with the <i>length</i> byte) to just before the checksum. Then the one's complement is calculated of this sum. The least significant byte of the result is the checksum. The sum of all bytes following the record type is 0xFF.

S1 / S2 / S3 - record

This record is the program code and data record for 2-byte, 3-byte or 4-byte addresses respectively.

S1	<i>length</i>	<i>address</i>	<i>code bytes</i>	<i>checksum</i>
S2	<i>length</i>	<i>address</i>	<i>code bytes</i>	<i>checksum</i>
S3	<i>length</i>	<i>address</i>	<i>code bytes</i>	<i>checksum</i>

where:

S1	is the program code and data record for 2-byte addresses.
S2	is the program code and data record for 3-byte addresses.
S3	is the program code and data record for 4-byte addresses (this is the default).
<i>length</i>	represents the number of bytes in the record, not including the record type and length byte. This value occupies one byte (two hexadecimal digits).
<i>address</i>	contains the code or data address.
<i>code bytes</i>	contains the actual program code and data.
<i>checksum</i>	is the record checksum. The checksum calculation is identical to S0.

Example:

```
S3070000FFFE6E6825
| | | | |
| | | | | _ checksum
| | | | | _ code
| | | | | _ address
| | | | | _ length
```

S7 / S8 / S9 - record

This record is the termination record for 4-byte, 3-byte or 2-byte addresses respectively.

S7	<i>length</i>	<i>address</i>	<i>checksum</i>
-----------	---------------	----------------	-----------------

S8	<i>length</i>	<i>address</i>	<i>checksum</i>
-----------	---------------	----------------	-----------------

S9	<i>length</i>	<i>address</i>	<i>checksum</i>
-----------	---------------	----------------	-----------------

where:

- S7** is the termination record for 4-byte addresses (this is the default). S7 is the corresponding termination record for S3 records.
 - S8** is the termination record for 3-byte addresses. S8 is the corresponding termination record for S2 records.
 - S9** is the termination record for 2-byte addresses. S9 is the corresponding termination record for S1 records.
- length* represents the number of bytes in the record, not including the record type and length byte. This value occupies one byte (two hexadecimal digits).
- address* contains the program start address.
- checksum* is the record checksum. The checksum calculation is identical to S0.

Example:

```
S70500000000FA
| | | | |
| | | | | _checksum
| | | | | _ address
| | | | | _ length
```

Chapter 17. Linker Script Language (LSL)

To make full use of the linker, you can write a script with information about the architecture of the target processor and locating information. The language for the script is called the *Linker Script Language (LSL)*. This chapter first describes the structure of an LSL file. The next section contains a summary of the LSL syntax. In the remaining sections, the semantics of the Linker Script Language is explained.

The TASKING linker is a target independent linker/locator that can simultaneously link and locate all programs for all cores available on a target board. The target board may be of arbitrary complexity. A simple target board may contain one standard processor with some external memory that executes one task. A complex target board may contain multiple standard processors and DSPs combined with configurable IP-cores loaded in an FPGA. Each core may execute a different program, and external memory may be shared by multiple cores.

LSL serves two purposes. First it enables you to specify the characteristics (that are of interest to the linker) of your specific target board and of the cores installed on the board. Second it enables you to specify how sections should be located in memory.

17.1. Structure of a Linker Script File

A script file consists of several definitions. The definitions can appear in any order.

The architecture definition (required)

In essence an *architecture definition* describes how the linker should convert logical addresses into physical addresses for a given type of core. If the core supports multiple address spaces, then for each space the linker must know how to perform this conversion. In this context a physical address is an offset on a given internal or external bus. Additionally the architecture definition contains information about items such as the (hardware) stack and the vector table.

This specification is normally written by Altium. Altium supplies LSL files in the `include.lsl` directory. The architecture definition of the LSL file should not be changed by you unless you also modify the core's hardware architecture. If the LSL file describes a multi-core system an architecture definition must be available for each different type of core.

See [Section 17.4, *Semantics of the Architecture Definition*](#) for detailed descriptions of LSL in the architecture definition.

The derivative definition

The *derivative definition* describes the configuration of the internal (on-chip) bus and memory system. Basically it tells the linker how to convert offsets on the buses specified in the architecture definition into offsets in internal memory. Microcontrollers and DSPs often have internal memory and I/O sub-systems apart from one or more cores. The design of such a chip is called a *derivative*.

When you build an ASIC or use a derivative that is not (yet) supported by the TASKING tools, you may have to write a derivative definition.

When you want to use multiple cores of the same type, you must instantiate the cores in a derivative definition, since the linker automatically instantiates only a single core for an unused architecture.

See [Section 17.5, *Semantics of the Derivative Definition*](#) for a detailed description of LSL in the derivative definition.

The processor definition

The *processor definition* describes an instance of a derivative. Typically the processor definition instantiates one derivative only (single-core processor). A processor that contains multiple cores having the same (homogeneous) or different (heterogeneous) architecture can also be described by instantiating multiple derivatives of the same or different types in separate processor definitions.

See [Section 17.6, *Semantics of the Board Specification*](#) for a detailed description of LSL in the processor definition.

The memory and bus definitions (optional)

Memory and bus definitions are used within the context of a derivative definition to specify internal memory and on-chip buses. In the context of a board specification the memory and bus definitions are used to define external (off-chip) memory and buses. Given the above definitions the linker can convert a logical address into an offset into an on-chip or off-chip memory device.

See [Section 17.6.3, *Defining External Memory and Buses*](#), for more information on how to specify the external physical memory layout. *Internal* memory for a processor should be defined in the derivative definition for that processor.

The board specification

The processor definition and memory and bus definitions together form a *board specification*. LSL provides language constructs to easily describe single-core and heterogeneous or homogeneous multi-core systems. The board specification describes all characteristics of your target board's system buses, memory devices, I/O sub-systems, and cores that are of interest to the linker. Based on the information provided in the board specification the linker can for each core:

- convert a logical address to an offset within a memory device
- locate sections in physical memory
- maintain an overall view of the used and free physical memory within the whole system while locating

The section layout definition (optional)

The optional section layout definition enables you to exactly control where input sections are located. Features are provided such as: the ability to place sections at a given load-address or run-time address, to place sections in a given order, and to overlay code and/or data sections.

Which object files (sections) constitute the task that will run on a given core is specified on the command line when you invoke the linker. The linker will link and locate all sections of all tasks simultaneously. From the section layout definition the linker can deduce where a given section may be located in memory,

form the board specification the linker can deduce which physical memory is (still) available while locating the section.

See [Section 17.8, *Semantics of the Section Layout Definition*](#), for more information on how to locate a section at a specific place in memory.

Skeleton of a Linker Script File

```
architecture architecture_name
{
    // Specification core architecture
}

derivative derivative_name
{
    // Derivative definition
}

processor processor_name
{
    // Processor definition
}

memory and/or bus definitions

section_layout space_name
{
    // section placement statements
}
```

17.2. Syntax of the Linker Script Language

This section describes what the LSL language looks like. An LSL document is stored as a file coded in UTF-8 with extension `.lsl`. Before processing an LSL file, the linker preprocesses it using a standard C preprocessor. Following this, the linker interprets the LSL file using a scanner and parser. Finally, the linker uses the information found in the LSL file to guide the locating process.

17.2.1. Preprocessing

When the linker loads an LSL file, the linker processes it with a C-style preprocessor. As such, it strips C and C++ comments. You can use the standard ISO C preprocessor directives, such as `#include`, `#define`, `#if/#ifdef/#else/#endif`, `#error`.

For example:

```
#include "arch.lsl"
```

Preprocess and include the file `arch.lsl` at this point in the LSL file.

17.2.2. Lexical Syntax

The following lexicon is used to describe the syntax of the Linker Script Language:

$A ::= B$	=	A is defined as B
$A ::= B C$	=	A is defined as B and C ; B is followed by C
$A ::= B \mid C$	=	A is defined as B or C
$\langle B \rangle^{0 1}$	=	zero or one occurrence of B
$\langle B \rangle^{>=0}$	=	zero or more occurrences of B
$\langle B \rangle^{>=1}$	=	one or more occurrences of B
<i>IDENTIFIER</i>	=	a character sequence starting with 'a'-'z', 'A'-'Z' or '_'. Following characters may also be digits and dots '.'
<i>STRING</i>	=	sequence of characters not starting with \n, \r or \t
<i>DQSTRING</i>	=	" <i>STRING</i> " (double quoted string)
<i>OCT_NUM</i>	=	octal number, starting with a zero (06, 045)
<i>DEC_NUM</i>	=	decimal number, not starting with a zero (14, 1024)
<i>HEX_NUM</i>	=	hexadecimal number, starting with '0x' (0x0023, 0xFF00)

OCT_NUM, *DEC_NUM* and *HEX_NUM* can be followed by a **k** (kilo), **M** (mega), or **G** (giga).

Characters in **bold** are characters that occur literally. Words in *italics* are higher order terms that are defined in the same or in one of the other sections.

To write comments in LSL file, you can use the C style `/* */` or C++ style `/**/`.

17.2.3. Identifiers and Tags

<i>arch_name</i>	::=	<i>IDENTIFIER</i>
<i>bus_name</i>	::=	<i>IDENTIFIER</i>
<i>core_name</i>	::=	<i>IDENTIFIER</i>
<i>derivative_name</i>	::=	<i>IDENTIFIER</i>
<i>file_name</i>	::=	<i>DQSTRING</i>
<i>group_name</i>	::=	<i>IDENTIFIER</i>
<i>heap_name</i>	::=	<i>section_name</i>
<i>map_name</i>	::=	<i>IDENTIFIER</i>
<i>mem_name</i>	::=	<i>IDENTIFIER</i>
<i>proc_name</i>	::=	<i>IDENTIFIER</i>
<i>section_name</i>	::=	<i>DQSTRING</i>
<i>space_name</i>	::=	<i>IDENTIFIER</i>
<i>stack_name</i>	::=	<i>section_name</i>
<i>symbol_name</i>	::=	<i>DQSTRING</i>

```

tag_attr      ::= (tag<,tag>>=0)
tag           ::= tag = DQSTRING

```

A tag is an arbitrary text that can be added to a statement.

17.2.4. Expressions

The expressions and operators in this section work the same as in ISO C.

```

number        ::= OCT_NUM
               | DEC_NUM
               | HEX_NUM

expr          ::= number
               | symbol_name
               | unary_op expr
               | expr binary_op expr
               | expr ? expr : expr
               | ( expr )
               | function_call

unary_op      ::= !      // logical NOT
               | ~      // bitwise complement
               | -      // negative value

binary_op     ::= ^      // exclusive OR
               | *      // multiplication
               | /      // division
               | %      // modulus
               | +      // addition
               | -      // subtraction
               | >>     // right shift
               | <<     // left shift
               | ==     // equal to
               | !=     // not equal to
               | >      // greater than
               | <      // less than
               | >=     // greater than or equal to
               | <=     // less than or equal to
               | &      // bitwise AND
               | |      // bitwise OR
               | &&     // logical AND
               | ||     // logical OR

```

17.2.5. Built-in Functions

```

function_call ::= absolute ( expr )
               | addressof ( addr_id )
               | checksum ( checksum_algo , expr , expr )
               | exists ( section_name )
               | max ( expr , expr )

```

TASKING VX-toolset for ARM User Guide

```
        | min ( expr , expr )  
        | sizeof ( size_id )  
  
addr_id      ::= sect : section_name  
                | group : group_name  
  
checksum_algo ::= crc32w  
  
size_id      ::= sect : section_name  
                | group : group_name  
                | mem : mem_name
```

- Every space, bus, memory, section or group you refer to, must be defined in the LSL file.
- The `addressof()` and `sizeof()` functions with the **group** or **sect** argument can only be used in the right hand side of an assignment. The `sizeof()` function with the **mem** argument can be used anywhere in section layouts.
- The `checksum()` function can only be used in a **struct** statement.

You can use the following built-in functions in expressions. All functions return a numerical value. This value is a 64-bit signed integer.

absolute()

```
int absolute( expr )
```

Converts the value of *expr* to a positive integer.

```
absolute( "labelA"-"labelB" )
```

addressof()

```
int addressof( addr_id )
```

Returns the address of *addr_id*, which is a named section or group. To get the offset of the section with the name `asect`:

```
addressof( sect: "asect" )
```

This function only works in assignments and **struct** statements.

checksum()

```
int checksum( checksum_algo, expr, expr )
```

Returns the computed checksum over a contiguous address range. The first argument specifies how the checksum must be computed (see below), the second argument is an expression that represents the start address of the range, while the third argument represents the end address (exclusive). The value of the end address expression must be strictly larger than the value of the start address (i.e. the size of the checksum address range must be at least one MAU). Each address in the range must point to a valid

memory location. Memory locations in the address range that are not occupied by a section are filled with zeros.

The only checksum algorithm (*checksum_algo*) currently supported is **crc32w**. This algorithm computes the checksum using a Cyclic Redundancy Check with the "CRC-32" polynomial 0xEDB88320. The input range is processed per 4-byte word. Those 4 bytes are passed to the checksum algorithm in reverse order if the target architecture is little-endian. For big-endian targets, this checksum algorithm is equal to a regular byte-wise CRC-32 implementation. Both the start address and end address values must be aligned on 4 MAUs. The behavior of this checksum algorithm is undefined when used in an address space that has a MAU size not equal to 8.

```
checksum( crc32w,  
         addressof( mem:foo ),  
         addressof( mem:foo ) + sizeof( mem:foo ) )
```

This function only works in **struct** statements.

exists()

```
int exists( section_name )
```

The function returns 1 if the section *section_name* exists in one or more object file, 0 otherwise. If the section is not present in input object files, but generated from LSL, the result of this function is undefined.

To check whether the section `mysection` exists in one of the object files that is specified to the linker:

```
exists( "mysection" )
```

max()

```
int max( expr, expr )
```

Returns the value of the expression that has the largest value. To get the highest value of two symbols:

```
max( "sym1" , "sym2" )
```

min()

```
int min( expr, expr )
```

Returns the value of the expression that has the smallest value. To get the lowest value of two symbols:

```
min( "sym1" , "sym2" )
```

sizeof()

```
int sizeof( size_id )
```

Returns the size of the object (group, section or memory) the identifier refers to. To get the size of the section "asection":

```
sizeof( sect: "asection" )
```

The **group** and **sect** arguments only works in assignments and **struct** statements. The **mem** argument can be used anywhere in section layouts.

17.2.6. LSL Definitions in the Linker Script File

```
description      ::= <definition>>=1
definition       ::= architecture_definition
                  | derivative_definition
                  | board_spec
                  | section_definition
                  | section_setup
```

- At least one *architecture_definition* must be present in the LSL file.

17.2.7. Memory and Bus Definitions

```
mem_def          ::= memory mem_name <tag_attr>0|1 { <mem_descr ;>=0 }
```

- A *mem_def* defines a memory with the *mem_name* as a unique name.

```
mem_descr        ::= type = <reserved>0|1 mem_type
                  | mau = expr
                  | size = expr
                  | speed = number
                  | priority = number
                  | exec_priority = number | fill <= fill_values>0|1
                  | mapping
```

- A *mem_def* contains exactly one **type** statement.
- A *mem_def* contains exactly one **mau** statement (non-zero size).
- A *mem_def* contains exactly one **size** statement.
- A *mem_def* contains zero or one **priority** (or **speed**) statement (if absent, the default value is 1).
- A *mem_def* contains zero or one **exec_priority** statement.
- A *mem_def* contains zero or one **fill** statement.
- A *mem_def* contains at least one *mapping*

```
mem_type         ::= rom           // attrs = rx
                  | ram           // attrs = rw
                  | nvram         // attrs = rwx
                  | blockram
```

```
fill_values ::= expr
            | [ expr <, expr>>=0 ]
```

```
bus_def ::= bus bus_name { <bus_descr ;>>=0 }
```

- A *bus_def* statement defines a bus with the given *bus_name* as a unique name within a core architecture.

```
bus_descr ::= mau = expr
           | width = expr // bus width, nr
           | // of data bits
           | mapping // legal destination
           | // 'bus' only
```

- The **mau** and **width** statements appear exactly once in a *bus_descr*. The default value for **width** is the **mau** size.
- The bus width must be an integer times the bus MAU size.
- The MAU size must be non-zero.
- A bus can only have a *mapping* on a destination bus (through **dest = bus:**).

```
mapping ::= map <map_name>0|1 ( map_descr <, map_descr>>=0 )
```

```
map_descr ::= dest = destination
           | dest_dbits = range
           | dest_offset = expr
           | size = expr
           | src_dbits = range
           | src_offset = expr
           | reserved
           | priority = number
           | exec_priority = number
           | tag
```

- A *map_descr* requires at least the **size** and **dest** statements.
- A *map_descr* contains zero or one **priority** statement (if absent, the default value is 0).
- A *map_descr* contains zero or one **exec_priority** statement.
- Each *map_descr* can occur only once.
- You can define multiple mappings from a single source.
- Overlap between source ranges or destination ranges is not allowed.
- If the **src_dbits** or **dest_dbits** statement is not present, its value defaults to the **width** value if the source/destination is a bus, and to the **mau** size otherwise.
- The **reserved** statement is allowed only in mappings defined for a memory.

TASKING VX-toolset for ARM User Guide

```
destination ::= space : space_name  
             | bus : <proc_name |  
                 core_name :>0|1 bus_name
```

- A *space_name* refers to a defined address space.
- A *proc_name* refers to a defined processor.
- A *core_name* refers to a defined core.
- A *bus_name* refers to a defined bus.
- The following mappings are allowed (source to destination)
 - space => space
 - space => bus
 - bus => bus
 - memory => bus

```
range ::= expr .. expr
```

- With address ranges, the end address is not part of the range.

17.2.8. Architecture Definition

```
architecture_definition ::= architecture arch_name  
                          <( parameter_list )>0|1  
                          extends arch_name  
                          <( argument_list )>0|1 >0|1  
                          { <arch_spec>>=0 }
```

- An *architecture_definition* defines a core architecture with the given *arch_name* as a unique name.
- At least one *space_def* and at least one *bus_def* have to be present in an *architecture_definition*.
- An *architecture_definition* that uses the **extends** construct defines an architecture that inherits all elements of the architecture defined by the second *arch_name*. The parent architecture must be defined in the LSL file as well.

```
parameter_list ::= parameter <, parameter>>=0
```

```
parameter ::= IDENTIFIER <= expr>0|1
```

```
argument_list ::= expr <, expr>>=0
```

```

arch_spec      ::= bus_def
                | space_def
                | endianness_def

space_def      ::= space space_name <tag_attr>0|1 { <space_descr;>=0 }

```

- A *space_def* defines an address space with the given *space_name* as a unique name within an architecture.

```

space_descr    ::= space_property ;
                | section_definition //no space ref
                | vector_table_statement
                | reserved_range

space_property ::= id = number // as used in object
                | mau = expr
                | align = expr
                | page_size = expr <[ range ] <| [ range ]>=0>0|1
                | page
                | direction = direction
                | stack_def
                | heap_def
                | copy_table_def
                | start_address
                | mapping

```

- A *space_def* contains exactly one **id** and one **mau** statement.
- A *space_def* contains at most one **align** statement.
- A *space_def* contains at most one **page_size** statement.
- A *space_def* contains at least one *mapping*.

```

stack_def      ::= stack stack_name ( stack_heap_descr
                                <, stack_heap_descr >=0 )

```

- A *stack_def* defines a stack with the *stack_name* as a unique name.

```

heap_def       ::= heap heap_name ( stack_heap_descr
                                <, stack_heap_descr >=0 )

```

- A *heap_def* defines a heap with the *heap_name* as a unique name.

```

stack_heap_descr ::= min_size = expr
                    | grows = direction
                    | align = expr
                    | fixed
                    | id = expr
                    | threads = expr
                    | tag

```

TASKING VX-toolset for ARM User Guide

- The **min_size** statement must be present.
- You can specify at most one **align** statement, one **grows** statement and one **threads** statement.
- Each stack definition has its own unique **id**, the number specified corresponds to the index in the **.CALLS** directive as generated by the compiler.

```
direction          ::= low_to_high
                   | high_to_low
```

- If you do not specify the **grows** statement, the stack and heap grow **low-to-high**.

```
copy_table_def    ::= copytable <( copy_table_descr
                                   <, copy_table_descr >=>0 )>0|1
```

- A *space_def* contains at most one **copytable** statement.
- Exactly one copy table must be defined in one of the spaces.

```
copy_table_descr  ::= align = expr
                   | copy_unit = expr
                   | dest <space_name>0|1 = space_name
                   | page
                   | tag
```

- The **copy_unit** is defined by the size in MAUs in which the startup code moves data.
- The **dest** statement is only required when the startup code initializes memory used by another processor that has no access to ROM.
- A *space_name* refers to a defined address space.

```
start_addr        ::= start_address ( start_addr_descr
                                       <, start_addr_descr>=>0 )
```

```
start_addr_descr  ::= run_addr = expr
                   | symbol = symbol_name
```

- A *symbol_name* refers to the section that contains the startup code.

```
vector_table_statement
                   ::= vector_table section_name
                       ( vecttab_spec <, vecttab_spec>=>0 )
                       { <vector_def>=>0 }
```

```
vecttab_spec      ::= vector_size = expr
                   | size = expr
                   | id_symbol_prefix = symbol_name
                   | run_addr = addr_absolute
                   | template = section_name
                   | template_symbol = symbol_name
                   | vector_prefix = section_name
                   | fill = vector_value
```

```

        | no_inline
        | copy
        | tag

vector_def ::= vector ( vector_spec <, vector_spec>>=0 );

vector_spec ::= id = vector_id_spec
        | fill = vector_value
        | optional
        | tag

vector_id_spec ::= number
        | [ range ] <, [ range ]>>=0

vector_value ::= symbol_name
        | [ number <, number>>=0 ]
        | loop <[ expr ]>0|1

reserved_range ::= reserved <tag_attr>0|1 expr .. expr ;

```

- The end address is not part of the range.

```

endianness_def ::= endianness { <endianness_type; >>=1 }

endianness_type ::= big
        | little

```

17.2.9. Derivative Definition

```

derivative_definition ::= derivative derivative_name
        <( parameter_list )>0|1
        <extends derivative_name
            <( argument_list )>0|1 >0|1
        { <derivative_spec>>=0 }

```

- A *derivative_definition* defines a derivative with the given *derivative_name* as a unique name.

```

derivative_spec ::= core_def
        | bus_def
        | mem_def
        | section_definition // no processor name
        | section_setup

core_def ::= core core_name { <core_descr ;>>=0 }

```

- A *core_def* defines a core with the given *core_name* as a unique name.
- At least one *core_def* must be present in a *derivative_definition*.

```
core_descr ::= architecture = arch_name
            <( argument_list )>0|1
            | endianness = ( endianness_type
                              <, endianness_type>>=0 )
```

- An *arch_name* refers to a defined core architecture.
- Exactly one **architecture** statement must be present in a *core_def*.

17.2.10. Processor Definition and Board Specification

```
board_spec ::= proc_def
              | bus_def
              | mem_def
```

```
proc_def ::= processor proc_name
             { proc_descr ; }
```

```
proc_descr ::= derivative = derivative_name
               <( argument_list )>0|1
```

- A *proc_def* defines a processor with the *proc_name* as a unique name.
- If you do not explicitly define a processor for a derivative in an LSL file, the linker defines a processor with the same name as that derivative.
- A *derivative_name* refers to a defined derivative.
- A *proc_def* contains exactly one **derivative** statement.

17.2.11. Section Setup

```
section_setup ::= section_setup space_ref <tag_attr>0|1
                  { <section_setup_item>>=0 }
```

```
section_setup_item ::= vector_table_statement
                       | reserved_range
                       | stack_def ;
                       | heap_def ;
                       | copy_table_def ;
                       | start_address ;
```

17.2.12. Section Layout Definition

```
section_definition ::= section_layout <space_ref>0|1
                       <( space_layout_properties )>0|1
                       { <section_statement>>=0 }
```

- A section definition inside a space definition does not have a *space_ref*.

- All global section definitions have a *space_ref*.

```
space_ref ::= <proc_name>0|1 : <core_name>0|1
           : space_name <| space_name>>=0
```

- If more than one processor is present, the *proc_name* must be given for a global section layout.
- If the section layout refers to a processor that has more than one core, the *core_name* must be given in the *space_ref*.
- A *proc_name* refers to a defined processor.
- A *core_name* refers to a defined core.
- A *space_name* refers to a defined address space.

```
space_layout_properties ::= space_layout_property <, space_layout_property >=0
```

```
space_layout_property ::= locate_direction
                       | tag
```

```
locate_direction ::= direction = direction
```

```
direction ::= low_to_high
            | high_to_low
```

- A section layout contains at most one **direction** statement.
- If you do not specify the **direction** statement, the locate direction of the section layout is **low-to-high**.

```
section_statement ::= simple_section_statement ;
                  | aggregate_section_statement
```

```
simple_section_statement ::= assignment
                        | select_section_statement
                        | special_section_statement
```

```
assignment ::= symbol_name assign_op expr
```

```
assign_op ::= =
           | :=
```

```
select_section_statement ::= select <ref_tree>0|1 <section_name>0|1
                           <section_selections>0|1
```

- Either a *section_name* or at least one *section_selection* must be defined.

TASKING VX-toolset for ARM User Guide

```
section_selection
    ::= ( section_selection
        <, section_selection>*> )
```

```
section_selection
    ::= attributes = < <+|-> attribute>*>
    | tag
```

- **+attribute** means: select all sections that have this attribute.
- **-attribute** means: select all sections that do not have this attribute.

```
special_section_statement
    ::= heap heap_name <stack_heap_mods>*>
    | stack stack_name <stack_heap_mods>*>
    | copytable
    | reserved section_name <reserved_specs>*>
```

- Special sections cannot be selected in load-time groups.

```
stack_heap_mods    ::= ( stack_heap_mod <, stack_heap_mod>*> )
```

```
stack_heap_mod     ::= size = expr
    | tag
```

```
reserved_specs     ::= ( reserved_spec <, reserved_spec>*> )
```

```
reserved_spec      ::= attributes
    | fill_spec
    | size = expr
    | alloc_allowed = absolute | ranged
```

- If a **reserved** section has attributes **r**, **rw**, **x**, **rx** or **rwX**, and no fill pattern is defined, the section is filled with zeros. If no attributes are set, the section is created as a scratch section (attributes **ws**, no image).

```
fill_spec          ::= fill = fill_values
```

```
fill_values        ::= expr
    | [ expr <, expr>*> ]
```

```
aggregate_section_statement
    ::= { <section_statement>*> }
    | group_descr
    | if_statement
    | section_creation_statement
    | struct_statement
```

```
group_descr        ::= group <group_name>*> <( group_specs )>*>
    section_statement
```

- For every group with a name, the linker defines a label.

- No two groups for address spaces of a core can have the same *group_name*.

```

group_specs      ::= group_spec <, group_spec >*=0
group_spec       ::= group_alignment
                  | attributes
                  | copy
                  | nocopy
                  | group_load_address
                  | fill <= fill_values>0|1
                  | group_page
                  | group_run_address
                  | group_type
                  | allow_cross_references
                  | priority = number
                  | tag
    
```

- The **allow-cross-references** property is only allowed for *overlay* groups.
- Sub groups inherit all properties from a parent group.

```

group_alignment  ::= align = expr
attributes       ::= attributes = <attribute>*=1
attribute        ::= r      // readable sections
                  | w      // writable sections
                  | x      // executable code sections
                  | i      // initialized sections
                  | s      // scratch sections
                  | b      // blanked (cleared) sections
                  | p      // protected sections

group_load_address ::= load_addr <= load_or_run_addr>0|1

group_page       ::= page <= expr>0|1
                  | page_size = expr <[ range ] <| [ range ]>*=0>0|1

group_run_address ::= run_addr <= load_or_run_addr>0|1

group_type       ::= clustered
                  | contiguous
                  | ordered
                  | overlay
    
```

- For *non-contiguous* groups, you can only specify *group_alignment* and *attributes*.
- The **overlay** keyword also sets the **contiguous** property.
- The **clustered** property cannot be set together with **contiguous** or **ordered** on a single group.

TASKING VX-toolset for ARM User Guide

```
load_or_run_addr ::= addr_absolute  
                  | addr_range <| addr_range> >=0
```

```
addr_absolute ::= expr  
               | memory_reference [ expr ]
```

- An absolute address can only be set on *ordered* groups.

```
addr_range ::= [ expr .. expr ]  
             | memory_reference  
             | memory_reference [ expr .. expr ]
```

- The parent of a group with an *addr_range* or **page** restriction cannot be **ordered**, **contiguous** or **clustered**.
- The end address is not part of the range.

```
memory_reference ::= mem : <proc_name :>0|1 mem_name </ map_name>0|1
```

- A *proc_name* refers to a defined processor.
- A *mem_name* refers to a defined memory.
- A *map_name* refers to a defined memory mapping.

```
if_statement ::= if ( expr ) section_statement  
              | else section_statement >0|1
```

```
section_creation_statement  
 ::= section section_name ( section_specs )  
    { <section_statement2> >=0 }
```

```
section_specs ::= section_spec <, section_spec >=0
```

```
section_spec ::= attributes  
              | fill_spec  
              | size = expr  
              | blocksize = expr  
              | overflow = section_name  
              | tag
```

```
section_statement2  
 ::= select_section_statement ;  
    | group_descr2  
    | { <section_statement2> >=0 }
```

```
group_descr2 ::= group <group_name>0|1  
              ( group_specs2 )  
              section_statement2
```

```
group_specs2 ::= group_spec2 <, group_spec2 >=0
```

```
group_spec2      ::= group_alignment  
                  | attributes  
                  | load_addr  
                  | tag  
  
struct_statement ::= struct { <struct_item>*=0 }  
  
struct_item      ::= expr : number ;
```

17.3. Expression Evaluation

Only *constant* expressions are allowed, including sizes, but not addresses, of sections in object files.

All expressions are evaluated with 64-bit precision integer arithmetic. The result of an expression can be absolute or relocatable. A symbol you assign is created as an absolute symbol. Symbol references are only allowed in symbol assignments and **struct** statements.

17.4. Semantics of the Architecture Definition

Keywords in the architecture definition

```
architecture
  extends
endianness          big little
bus
  mau
  width
  map
space
  id
  mau
  align
  page_size
  page
  direction          low_to_high high_to_low
  stack
  min_size
  grows              low_to_high high_to_low
  align
  fixed
  id
  threads
  heap
  min_size
  grows              low_to_high high_to_low
  align
  fixed
  id
  threads
  copytable
  align
  copy_unit
  dest
  page
  vector_table
  vector_size
  size
  id_symbol_prefix
  run_addr
  template
  template_symbol
  vector_prefix
  fill
  no_inline
  copy
  vector
```

```

        id
        fill          loop
        optional
reserved
start_address
    run_addr
    symbol
map
map
    dest          bus space
    dest_dbits
    dest_offset
    size
    src_dbits
    src_offset
    priority
    exec_priority

```

17.4.1. Defining an Architecture

With the keyword **architecture** you define an architecture and assign a unique name to it. The name is used to refer to it at other places in the LSL file:

```

architecture name
{
    definitions
}

```

If you are defining multiple core architectures that show great resemblance, you can define the common features in a parent core architecture and extend this with a child core architecture that contains specific features. The child inherits all features of the parent. With the keyword **extends** you create a child core architecture:

```

architecture name_child_arch extends name_parent_arch
{
    definitions
}

```

A core architecture can have any number of parameters. These are identifiers which get values assigned on instantiation or extension of the architecture. You can use them in any expression within the core architecture. Parameters can have default values, which are used when the core architecture is instantiated with less arguments than there are parameters defined for it. When you extend a core architecture you can pass arguments to the parent architecture. Arguments are expressions that set the value of the parameters of the sub-architecture.

```

architecture name_child_arch (parm1,parm2=1)
    extends name_parent_arch (arguments)
{
    definitions
}

```

17.4.2. Defining Internal Buses

With the `bus` keyword you define a bus (the combination of data and corresponding address bus). The bus name is used to identify a bus and does not conflict with other identifiers. Bus descriptions in an architecture definition or derivative definition define *internal* buses. Some internal buses are used to communicate with the components outside the core or processor. Such buses on a processor have physical pins reserved for the number of bits specified with the `width` statements.

- The `mau` field specifies the MAU size (Minimum Addressable Unit) of the data bus. This field is required.
- The `width` field specifies the width (number of address lines) of the data bus. The default value is the MAU size.
- The `map` keyword specifies how this bus maps onto another bus (if so). Mappings are described in [Section 17.4.4, *Mappings*](#).

```
bus bus_name
{
    mau = 8;
    width = 8;
    map ( map_description );
}
```

17.4.3. Defining Address Spaces

With the `space` keyword you define a logical address space. The space name is used to identify the address space and does not conflict with other identifiers.

- The `id` field defines how the addressing space is identified in object files. In general, each address space has a unique ID. The linker locates sections with a certain ID in the address space with the same ID. This field is required.
- The `mau` field specifies the MAU size (Minimum Addressable Unit) of the space. This field is required.
- The `align` value must be a power of two. The linker uses this value to compute the start addresses when sections are concatenated. An align value of *n* means that objects in the address space have to be aligned on *n* MAUs.
- The `page_size` field sets the page alignment and page size in MAUs for the address space. It must be a power of 2. The default value is 1. If one or more page ranges are supplied the supplied value only sets the page alignment. The ranges specify the available space in each page, as offsets to the page start, which is aligned at the page alignment.

See also the `page` keyword in subsection [Locating a group](#) in [Section 17.8.2, *Creating and Locating Groups of Sections*](#).

- With the optional `direction` field you can specify how all sections in this space should be located. This can be either from `low_to_high` addresses (this is the default) or from `high_to_low` addresses.
- The `map` keyword specifies how this address space maps onto an internal bus or onto another address space. Mappings are described in [Section 17.4.4, *Mappings*](#).

Stacks and heaps

- The **stack** keyword defines a stack in the address space and assigns a name to it. The architecture definition must contain at least one stack definition. Each stack of a core architecture must have a unique name. See also the **stack** keyword in [Section 17.8.3, *Creating or Modifying Special Sections*](#).

The stack is described in terms of a minimum size (**min_size**) and the direction in which the stack grows (**grows**). This can be either from **low_to_high** addresses (stack grows upwards, this is the default) or from **high_to_low** addresses (stack grows downwards). The **min_size** is required.

By default, the linker tries to maximize the size of the stacks and heaps. After locating all sections, the largest remaining gap in the space is used completely for the stacks and heaps. If you specify the keyword **fixed**, you can disable this so-called 'balloon behavior'. The size is also fixed if you used a stack or heap in the software layout definition in a restricted way. For example when you override a stack with another size or select a stack in an ordered group with other sections.

The **id** keyword matches stack information generated by the compiler with a stack name specified in LSL. This value assigned to this keyword is strongly related to the compiler's output, so users are not supposed to change this configuration.

Optionally you can specify an alignment for the stack with the argument **align**. This alignment must be equal or larger than the alignment that you specify for the address space itself.

For each stack, a stack size estimation may be computed (and listed in a map file) from a call graph. Each root node of the call graph is treated as a separate thread that can run independently from the other threads. The estimated stack usage for a root node is the highest sum of stack usage values along a path to a leaf node. The total estimated stack usage of a link task is the sum of the calculated stack usage of such independent call graphs. If only a limited number of these threads can make use of a specific stack at a time, you can specify this by assigning a number to the **threads** keyword on that stack's definition. When **threads** is set to *n*, only the *n* highest stack usage numbers of root nodes are summed. A **threads** argument equal to zero or negative is ignored.

- The **heap** keyword defines a heap in the address space and assigns a name to it. The definition of a heap is similar to the definition of a stack. See also the **heap** keyword in [Section 17.8.3, *Creating or Modifying Special Sections*](#).

Stacks and heaps are only generated by the linker if the corresponding linker labels are referenced in the object files.

See [Section 17.8, *Semantics of the Section Layout Definition*](#), for information on creating and placing stack sections.

Copy tables

- The **copytable** keyword defines a copy table in the address space. The content of the copy table is created by the linker and contains the start address and size of all sections that should be initialized by the startup code. You must define exactly one copy table in one of the address spaces (for a core).

Optionally you can specify an alignment for the copy table with the argument **align**. This alignment must be equal or larger than the alignment that you specify for the address space itself. If smaller, the alignment for the address space is used.

The `copy_unit` argument specifies the size in MAUs of information chunks that are copied. If you do not specify the copy unit, the MAU size of the address space itself is used.

The `dest` argument specifies the destination address space that the code uses for the copy table. The linker uses this information to generate the correct addresses in the copy table. The memory into where the sections must be copied at run-time, must be accessible from this destination space.

Sections generated for the copy table may get a page restriction with the address space's page size, by adding the `page` argument.

Vector table

- The `vector_table` keyword defines a vector table with n vectors of size m (This is an internal LSL object similar to an LSL group.) The `run_addr` argument specifies the location of the first vector (`id=0`). This can be a simple address or an offset in memory (see the description of the run-time address in subsection [Locating a group](#) in [Section 17.8.2, Creating and Locating Groups of Sections](#)). A vector table defines symbols `_lc_ub_foo` and `_lc_ue_foo` pointing to start and end of the table.

```
vector_table "vector_table" (vector_size=m, size=n, run_addr=x, ...)
```

See the following example of a vector table definition:

```
vector_table "vector_table" (vector_size = 4, size = 16, run_addr=0,
    template=".text.handler_address",
    template_symbol="_lc_vector_handler",
    vector_prefix="_vector_",
    id_symbol_prefix="foo",
    no_inline,
    /* default: empty, or */
    fill="foo", /* or */
    fill=[1,2,3,4], /* or */
    fill=loop)
{
    vector (id=23, fill="main", optional);
    vector (id=12, fill=[0xab, 0x21, 0x32, 0x43]);
    vector (id=[1..11], fill=[0]);
    vector (id=[18..23], fill=loop);
}
```

The `template` argument defines the name of the section that holds the code to jump to a handler function from the vector table. This template section does not get located and is removed when the locate phase is completed. This argument is required.

The `template_symbol` argument is the symbol reference in the template section that must be replaced by the address of the handler function. This symbol name should start with the linker prefix for the symbol to be ignored in the link phase. This argument is required.

The `vector_prefix` argument defines the names of vector sections: the section for a vector with `vector_id` is `$(vector_prefix)$(vector_id)`. Vectors defined in C or assembly source files that should be included in the vector table must have the correct symbol name. The compiler uses the prefix that is defined in the default LSL file(s); if this attribute is changed, the vectors declared in C source files are

not included in the vector table. When a vector supplied in an object file has exactly one relocation, the linker will assume it is a branch to a handler function, and can be removed when the handler is inlined in the vector table. Otherwise, no inlining is done. This argument is required.

With the optional `no_inline` argument the vectors handlers are not inlined in the vector table.

With the optional `copy` argument a ROM copy of the vector table is made and the vector table is copied to RAM at startup.

With the optional `id_symbol_prefix` argument you can set an internal string representing a symbol name prefix that may be found on symbols in vector handler code. When the linker detects such a symbol in a handler, the symbol is assigned the vector number. If the symbol was already assigned a vector number, a warning is issued.

The `fill` argument sets the default contents of vectors. If nothing is specified for a vector, this setting is used. See below. When no default is provided, empty vectors may be used to locate large vector handlers and other sections. Only one `fill` argument is allowed.

The `vector` field defines the content of vector with the number specified by `id`. If a range is specified for `id` (`[p . q, s . . t]`) all vectors in the ranges (inclusive) are defined the same way.

With `fill=symbol_name`, the vector must jump to this symbol. If the section in which the symbol is defined fits in the vector table (size may be $>m$), locate the section at the location of the vector. Otherwise, insert code to jump to the symbol's value. A template interrupt handler section name + symbol name for the target code must be supplied in the LSL file.

`fill=[value(s)]`, fills the vector with the specified MAU values.

With `fill=loop` the vector jumps to itself. With the optional `[offset]` you can specify an offset from the vector table entry.

When the keyword `optional` is set on a vector specification with a symbol value and the symbol is not found, no error is reported. A default fill value is used if the symbol was not found. With other values the attribute has no effect.

Reserved address ranges

- The `reserved` keyword specifies to reserve a part of an address space even if not all of the range is covered by memory. See also the `reserved` keyword in [Section 17.8.3, *Creating or Modifying Special Sections*](#).

Start address

- The `start_address` keyword specifies the start address for the position where the C startup code is located. When a processor is reset, it initializes its program counter to a certain start address, sometimes called the reset vector. In the architecture definition, you must specify this start address in the correct address space in combination with the name of the label in the application code which must be located here.

The `run_addr` argument specifies the start address (reset vector). If the core starts executing using an entry from a vector table, and directly jumps to the start label, you should omit this argument.

The **symbol** argument specifies the name of the label in the application code that should be located at the specified start address. The **symbol** argument is required. The linker will resolve the start symbol and use its value after locating for the start address field in IEEE-695 files and Intel Hex files. If you also specified the **run_addr** argument, the start symbol (label) must point to a section. The linker locates this section such that the start symbol ends up on the start address.

```
space space_name
{
    id = 1;
    mau = 8;
    align = 8;
    page_size = 1;
    stack name (min_size = 1k, grows = low_to_high);
    reserved start_address .. end_address;
    start_address ( run_addr = 0x0000,
                   symbol = "start_label" )
    map ( map_description );
}
```

17.4.4. Mappings

You can use a mapping when you define a space, bus or memory. With the **map** field you specify how addresses from the source (space, bus or memory) are translated to addresses of a destination (space, bus). The following mappings are possible:

- space => space
- space => bus
- bus => bus
- memory => bus

With a mapping you specify a range of source addresses you want to map (specified by a source offset and a size), the destination to which you want to map them (a bus or another address space), and the offset address in the destination.

- The **dest** argument specifies the destination. This can be a **bus** or another address **space** (only for a space to space mapping). This argument is required.
- The **src_offset** argument specifies the offset of the source addresses. In combination with size, this specifies the range of address that are mapped. By default the source offset is 0x0000.
- The **size** argument specifies the number of addresses that are mapped. This argument is required.
- The **dest_offset** argument specifies the position in the destination to which the specified range of addresses is mapped. By default the destination offset is 0x0000.

If you are mapping a bus to another bus, the number of data lines of each bus may differ. In this case you have to specify a range of source data lines you want to map (**src_dbits = begin..end**) and the range of destination data lines you want to map them to (**dest_dbits = first..last**).

- The `src_dbits` argument specifies a range of data lines of the source bus. By default all data lines are mapped.
- The `dest_dbits` argument specifies a range of data lines of the destination bus. By default, all data lines from the source bus are mapped on the data lines of the destination bus (starting with line 0).

If you define a memory and the memory mapping must not be used by default when locating sections in address spaces, you can specify the `reserved` argument. This marks all address space areas that the mapping points to as reserved. If a section has an absolute or address range restriction, the reservation is lifted and the section may be located at these locations. This feature is only useful when more than one mapping is available for a range of memory addresses, otherwise the `memory` keyword with the same name would be used.

For example:

```
memory xrom
{
    mau = 8;
    size = 1M;
    type = rom;
    map cached (dest=bus:mycore:local_bus, dest_offset=0x80000000,
                size=1M);
    map uncached (dest=bus:mycore:local_bus, dest_offset=0xa0000000,
                  size=1M, reserved);
}
```

Mapping priority

If you define a memory you can set a locate priority on a mapping with the keywords `priority` and `exec_priority`. The values of these priorities are relative which means they add to the priority of memories. Whereas a priority set on the memory applies to all address space areas reachable through any mapping of the memory, a priority set on a mapping only applies to address space areas reachable through the mapping. The memory mapping with the highest priority is considered first when locating. To set only a priority for non-executable (data) sections, add a `priority` keyword with the desired value and an `exec_priority` set to zero. To set only a priority for executable (code) sections, simply set an `exec_priority` keyword to the desired value.

The default for a mapping `priority` is zero, while the default for `exec_priority` is the same as the specified `priority`. If you specify a value for `priority` in LSL it must be greater than zero. A value for `exec_priority` must be greater or equal to zero.

For more information about priority values see the description of the [memory priority keyword](#).

```
memory myram
{
    mau = 8;
    size = 112k;
    type = ram;
    map (dest=bus:mycore:local_bus, dest_offset=0xd0000000,
         size=112k, priority=8, exec_priority=0);
    map (dest=bus:mycore:local_bus, dest_offset=0x70000000,
```

```
        size=112k);  
}
```

From space to space

If you map an address space to another address space (nesting), you can do this by mapping the subspace to the containing larger space. In this example a small space of 64 kB is mapped on a large space of 16 MB.

```
space small  
{  
    id = 2;  
    mau = 4;  
    map (src_offset = 0, dest_offset = 0,  
        dest = space : large, size = 64k);  
}
```

From space to bus

All spaces that are not mapped to another space must map to a bus in the architecture:

```
space large  
{  
    id = 1;  
    mau = 4;  
    map (src_offset = 0, dest_offset = 0,  
        dest = bus:bus_name, size = 16M );  
}
```

From bus to bus

The next example maps an external bus called `e_bus` to an internal bus called `i_bus`. This internal bus resides on a core called `mycore`. The source bus has 16 data lines whereas the destination bus has only 8 data lines. Therefore, the keywords `src_dbits` and `dest_dbits` specify which source data lines are mapped on which destination data lines.

```
architecture mycore  
{  
    bus i_bus  
    {  
        mau = 4;  
    }  
  
    space i_space  
    {  
        map (dest=bus:i_bus, size=256);  
    }  
}  
  
bus e_bus  
{
```

```

    mau = 16;
    width = 16;
    map (dest = bus:mycore:i_bus, src_dbits = 0..7, dest_dbits = 0..7 )
}

```

It is not possible to map an internal bus to an external bus.

17.5. Semantics of the Derivative Definition

Keywords in the derivative definition

```

derivative
  extends
core
  architecture
bus
  mau
  width
  map
memory
  type          reserved rom  ram  nvram  blockram
  mau
  size
  speed
  priority
  exec_priority
  fill
  map
section_layout
section_setup

  map
    dest          bus  space
    dest_dbits
    dest_offset
    size
    src_dbits
    src_offset
    priority
    exec_priority
    reserved

```

17.5.1. Defining a Derivative

With the keyword **derivative** you define a derivative and assign a unique name to it. The name is used to refer to it at other places in the LSL file:

```
derivative name
{
    definitions
}
```

If you are defining multiple derivatives that show great resemblance, you can define the common features in a parent derivative and extend this with a child derivative that contains specific features. The child inherits all features of the parent (cores and memories). With the keyword **extends** you create a child derivative:

```
derivative name_child_deriv extends name_parent_deriv
{
    definitions
}
```

As with a core architecture, a derivative can have any number of parameters. These are identifiers which get values assigned on instantiation or extension of the derivative. You can use them in any expression within the derivative definition.

```
derivative name_child_deriv (parm1,parm2=1)
    extends name_parent_deriv (arguments)
{
    definitions
}
```

17.5.2. Instantiating Core Architectures

With the keyword **core** you instantiate a core architecture in a derivative.

- With the keyword **architecture** you tell the linker that the given core has a certain architecture. The architecture name refers to an existing architecture definition in the same LSL file.

For example, if you have two cores (called `mycore_1` and `mycore_2`) that have the same architecture (called `mycorearch`), you must instantiate both cores as follows:

```
core mycore_1
{
    architecture = mycorearch;
}

core mycore_2
{
    architecture = mycorearch;
}
```

If the architecture definition has parameters you must specify the arguments that correspond with the parameters. For example `mycorearch1` expects two parameters which are used in the architecture definition:

```
core mycore
{
```



```

    architecture = mycorearch1 (1,2);
}

```

17.5.3. Defining Internal Memory and Buses

With the keyword **memory** you define physical memory that is present on the target board. The memory name is used to identify the memory and does not conflict with other identifiers. It is common to define internal memory (on-chip) in the derivative definition. External memory (off-chip memory) is usually defined in the board specification (See [Section 17.6.3, *Defining External Memory and Buses*](#)).

- The **type** field specifies a memory type:
 - **rom**: read-only memory - it can only be written at load-time
 - **ram**: random access volatile writable memory - writing at run-time is possible while writing at load-time has no use since the data is not retained after a power-down
 - **nvr****am**: non volatile ram - writing is possible both at load-time and run-time
 - **blockram**: writing is possible both at load-time and run-time. Changes are applied in RAM, so after a full device reset the data in a blockram reverts to the original state.

The optional **reserved** qualifier before the memory type, tells the linker not to locate any section in the memory by default. You can locate sections in such memories using an absolute address or range restriction (see subsection [Locating a group in Section 17.8.2, *Creating and Locating Groups of Sections*](#)).

- The **mau** field specifies the MAU size (Minimum Addressable Unit) of the memory. This field is required.
- The **size** field specifies the size in MAU of the memory. This field is required.
- The **priority** field specifies a locate priority for a memory. The **speed** field has the same meaning but is considered deprecated. By default, a memory has its priority set to 1. The memories with the highest priority are considered first when trying to locate a rule. Subsequently, the next highest priority memories are added if the rule was not located successfully, and so on until the lowest priority that is available is reached or the rule is located. The lowest priority value is zero. Sections with an **ordered** and/or **contiguous** restriction are not affected by the locate priority. If such sections also have a **page** restriction, the locate priority is still used to select a page.
- If an **exec_priority** is specified for a memory, the regular priority (either specified or its default value) does not apply to locate rules with only executable sections. Instead, the supplied value applies for such rules. Additionally, the **exec_priority** value is used for any executable unrestricted sections, even if they appear in an unrestricted rule together with non-executable sections.
- The **map** field specifies how this memory maps onto an (internal) bus. The mapping can have a name. Mappings are described in [Section 17.4.4, *Mappings*](#).
- The optional **fill** field contains a bit pattern that the linker writes to all memory addresses that remain unoccupied during the locate process. The result of the expression, or list of expressions, is used as values to write to memory, each in MAU.

```
memory mem_name
{
    type = rom;
    mau = 8;
    fill = 0xaa;
    size = 64k;
    priority = 2;
    map map_name ( map_description );
}
```

With the **bus** keyword you define a bus in a derivative definition. Buses are described in [Section 17.4.2, Defining Internal Buses](#).

17.6. Semantics of the Board Specification

Keywords in the board specification

```
processor
    derivative
bus
    mau
    width
    map
memory
    type          reserved rom ram nvram blockram
    mau
    size
    speed
    priority
    exec_priority
    fill
    map

    map
        dest          bus space
        dest_dbits
        dest_offset
        size
        src_dbits
        src_offset
        priority
        exec_priority
        reserved
```

17.6.1. Defining a Processor

If you have a target board with multiple processors that have the same derivative, you need to instantiate each individual processor in a processor definition. This information tells the linker which processor has which derivative and enables the linker to distinguish between the present processors.

If you use processors that all have a unique derivative, you may omit the processor definitions. In this case the linker assumes that for each derivative definition in the LSL file there is one processor. The linker uses the derivative name also for the processor.

With the keyword **processor** you define a processor. You can freely choose the processor name. The name is used to refer to it at other places in the LSL file:

```
processor proc_name
{
    processor definition
}
```

17.6.2. Instantiating Derivatives

With the keyword **derivative** you tell the linker that the given processor has a certain derivative. The derivative name refers to an existing derivative definition in the same LSL file.

For example, if you have two processors on your target board (called `myproc_1` and `myproc_2`) that have the same derivative (called `myderiv`), you must instantiate both processors as follows:

```
processor myproc_1
{
    derivative = myderiv;
}

processor myproc_2
{
    derivative = myderiv;
}
```

If the derivative definition has parameters you must specify the arguments that correspond with the parameters. For example `myderiv1` expects two parameters which are used in the derivative definition:

```
processor myproc
{
    derivative = myderiv1 (2,4);
}
```

17.6.3. Defining External Memory and Buses

It is common to define external memory (off-chip) and external buses at the global scope (outside any enclosing definition). Internal memory (on-chip memory) is usually defined in the scope of a derivative definition.

With the keyword **memory** you define physical memory that is present on the target board. The memory name is used to identify the memory and does not conflict with other identifiers. If you define memory parts in the LSL file, only the memory defined in these parts is used for placing sections.

If no external memory is defined in the LSL file and if the linker option to allocate memory on demand is set then the linker will assume that all virtual addresses are mapped on physical memory. You can override this behavior by specifying one or more memory definitions.

```
memory mem_name
{
    type = rom;
    mau = 8;
    fill = 0xaa;
    size = 64k;
    priority = 2;
    map map_name ( map_description );
}
```

For a description of the keywords, see [Section 17.5.3, Defining Internal Memory and Buses](#).

With the keyword **bus** you define a bus (the combination of data and corresponding address bus). The bus name is used to identify a bus and does not conflict with other identifiers. Bus descriptions at the global scope (outside any definition) define external buses. These are buses that are present on the target board.

```
bus bus_name
{
    mau = 8;
    width = 8;
    map ( map_description );
}
```

For a description of the keywords, see [Section 17.4.2, Defining Internal Buses](#).

You can connect off-chip memory to any derivative: you need to map the off-chip memory to a bus and map that bus on the internal bus of the derivative you want to connect it to.

17.7. Semantics of the Section Setup Definition

Keywords in the section setup definition

```
section_setup
  stack
    min_size
    grows          low_to_high  high_to_low
    align
    fixed
    id
  heap
    min_size
    grows          low_to_high  high_to_low
    align
    fixed
    id
```

```

copytable
  align
  copy_unit
  dest
  page
vector_table
  vector_size
  size
  id_symbol_prefix
  run_addr
  template
  template_symbol
  vector_prefix
  fill
  no_inline
  copy
  vector
    id
    fill      loop
    optional
reserved
start_address
  run_addr
  symbol

```

17.7.1. Setting up a Section

With the keyword **section_setup** you can define stacks, heaps, copy tables, vector tables, start address and/or reserved address ranges outside their address space definition.

```

section_setup ::my_space
{
  vector table statements
  reserved address range
  stack definition
  heap definition
  copy table definition
  start address
}

```

See the subsections [Stacks and heaps](#), [Copy tables](#), [Start address](#), [Vector table](#) and [Reserved address ranges](#) in [Section 17.4.3, Defining Address Spaces](#) for details on the keywords **stack**, **heap**, **copytable**, **vector_table** and **reserved**.

17.8. Semantics of the Section Layout Definition

Keywords in the section layout definition

```
section_layout
  direction      low_to_high high_to_low
group
  align
  attributes     + - r w x b i s p
  copy
  nocopy
  fill
  ordered
  contiguous
  clustered
  overlay
  allow_cross_references
  load_addr
    mem
  run_addr
    mem
  page
  page_size
  priority
select
stack
  size
heap
  size
reserved
  size
  attributes     r w x
  fill
  alloc_allowed absolute ranged
copytable
section
  size
  blocksize
  attributes     r w x
  fill
  overflow
struct
  checksum

if
else
```

17.8.1. Defining a Section Layout

With the keyword `section_layout` you define a section layout for exactly one address space. In the section layout you can specify how input sections are placed in the address space, relative to each other, and what the absolute run and load addresses of each section will be.

You can define one or more section definitions. Each section definition arranges the sections in one address space. You can precede the address space name with a processor name and/or core name, separated by colons. You can omit the processor name and/or the core name if only one processor is defined and/or only one core is present in the processor. A reference to a space in the only core of the only processor in the system would look like `::my_space`. A reference to a space of the only core on a specific processor in the system could be `my_chip::my_space`. The next example shows a section definition for sections in the `my_space` address space of the processor called `my_chip`:

```
section_layout my_chip::my_space ( locate_direction )
{
    section statements
}
```

Locate direction

With the optional keyword `direction` you specify whether the linker starts locating sections from `low_to_high` (default) or from `high_to_low`. In the second case the linker starts locating sections at the highest addresses in the address space but preserves the order of sections when necessary (one processor and core in this example).

```
section_layout ::my_space ( direction = high_to_low )
{
    section statements
}
```

If you do not explicitly tell the linker how to locate a section, the linker decides on the basis of the section attributes in the object file and the information in the architecture definition and memory parts where to locate the section.

17.8.2. Creating and Locating Groups of Sections

Sections are located per group. A group can contain one or more (sets of) input sections as well as other groups. Per group you can assign a mutual order to the sets of sections and locate them into a specific memory part.

```
group ( group_specifications )
{
    section_statements
}
```

With the `section_statements` you generally select sets of sections to form the group. This is described in subsection [Selecting sections for a group](#).

TASKING VX-toolset for ARM User Guide

Instead of selecting sections, you can also modify special sections like stack and heap or create a reserved section. This is described in [Section 17.8.3, *Creating or Modifying Special Sections*](#).

With the *group_specifications* you actually locate the sections in the group. This is described in subsection [Locating a group](#).

Selecting sections for a group

With the keyword `select` you can select one or more sections for the group. You can select a section by name or by attributes. If you select a section by name, you can use a wildcard pattern:

- * matches with all section names
- ? matches with a single character in the section name
- \ takes the next character literally
- [abc] matches with a single 'a', 'b' or 'c' character
- [a-z] matches with any single character in the range 'a' to 'z'

```
group ( ... )  
{  
    select "mysection";  
    select "*";  
}
```

The first `select` statement selects the section with the name "mysection". The second `select` statement selects all sections that were not selected yet.

A section is selected by the first select statement that matches, in the union of all section layouts for the address space. Global section layouts are processed in the order in which they appear in the LSL file. Internal core architecture section layouts always take precedence over global section layouts.

- The `attributes` field selects all sections that carry (or do not carry) the given attribute. With `+attribute` you select sections that have the specified attribute set. With `-attribute` you select sections that do not have the specified attribute set. You can specify one or more of the following attributes:
 - `r` readable sections
 - `w` writable sections
 - `x` executable sections
 - `i` initialized sections
 - `b` sections that should be cleared at program startup
 - `s` scratch sections (not cleared and not initialized)
 - `p` protected sections

To select all read-only sections:

```
group ( ... )
{
    select (attributes = +r-w);
}
```

Keep in mind that all section selections are restricted to the address space of the section layout in which this group definition occurs.

- With the `ref_tree` field you can select a group of related sections. The relation between sections is often expressed by means of references. By selecting just the 'root' of tree, the complete tree is selected. This is for example useful to locate a group of related sections in special memory (e.g. fast memory). The (referenced) sections must meet the following conditions in order to be selected:

1. The sections are within the section layout's address space
2. The sections match the specified attributes
3. The sections have no absolute restriction (as is the case for all wildcard selections)

For example, to select the code sections referenced from `foo1`:

```
group refgrp (ordered, contiguous, run_addr=mem:ext_c)
{
    select ref_tree "foo1" (attributes=+x);
}
```

If section `foo1` references `foo2` and `foo2` references `foo3`, then all these sections are selected by the selection shown above.

Locating a group

```
group group_name ( group_specifications )
{
    section_statements
}
```

With the `group_specifications` you actually define how the linker must locate the group. You can roughly define three things: 1) assign properties to the sections in a group like alignment and read/write attributes, 2) define the mutual order in the address space for sections in the group and 3) restrict the possible addresses for the sections in a group.

The linker creates labels that allow you to refer to the begin and end address of a group from within the application software. Labels `_lc_gb_group_name` and `_lc_ge_group_name` mark the begin and end of the group respectively, where the begin is the lowest address used within this group and the end is the highest address used. Notice that a group not necessarily occupies all memory between begin and end address. The given label refers to where the section is located at run-time (versus load-time).

1. Assign properties to the sections in a group like alignment and read/write attributes.

These properties are assigned to all sections in the group (and subgroups) and override the attributes of the input sections.

- The **align** field tells the linker to align all sections in the group according to the align value. The alignment of a section is first determined by its own initial alignment and the defined alignment for the address space. Alignments are never decreased, if multiple alignments apply to a section, the largest one is used.
- The **attributes** field tells the linker to assign one or more attributes to all sections in the group. This overrides the default attributes. By default the linker uses the attributes of the input sections. You can set the **r**, **w**, or **rw** attributes and you can switch between the **b** and **s** attributes.
- The **copy** field tells the linker to locate a read-only section in RAM and generate a ROM copy and a copy action in the copy table. This property makes the sections in the group writable which causes the linker to generate ROM copies for the sections.
- The effect of the **nocopy** field is the opposite of the **copy** field. It prevents the linker from generating ROM copies of the selected sections.

2. Define the mutual order of the sections in the group.

By default, a group is *unrestricted* which means that the linker has total freedom to place the sections of the group in the address space.

- The **ordered** keyword tells the linker to locate the sections in the same order in the address space as they appear in the group (but not necessarily adjacent).

Suppose you have an ordered group that contains the sections 'A', 'B' and 'C'. By default the linker places the sections in the address space like 'A' - 'B' - 'C', where section 'A' gets the lowest possible address. With **direction=high_to_low** in the **section_layout** space properties, the linker places the sections in the address space like 'C' - 'B' - 'A', where section 'A' gets the highest possible address.

- The **contiguous** keyword tells the linker to locate the sections in the group in a single address range. Within a contiguous group the input sections are located in arbitrary order, however the group occupies one contiguous range of memory. Due to alignment of sections there can be 'alignment gaps' between the sections.

When you define a group that is both **ordered** and **contiguous**, this is called a *sequential* group. In a sequential group the linker places sections in the same order in the address space as they appear in the group and it occupies a contiguous range of memory.

- The **clustered** keyword tells the linker to locate the sections in the group in a number of *contiguous* blocks. It tries to keep the number of these blocks to a minimum. If enough memory is available, the group will be located as if it was specified as **contiguous**. Otherwise, it gets split into two or more blocks.

If a contiguous or clustered group contains *alignment gaps*, the linker can locate sections that are not part of the group in these gaps. To prevent this, you can use the **fill** keyword. If the group is located in RAM, the gaps are treated as reserved (scratch) space. If the group is located in ROM, the alignment gaps are filled with zeros by default. You can however change the fill pattern by specifying a bit pattern. The result of the expression, or list of expressions, is used as values to write to memory, each in MAU.

- The **overlay** keyword tells the linker to overlay the sections in the group. The linker places all sections in the address space using a contiguous range of addresses. (Thus an overlay group is automatically also a contiguous group.) To overlay the sections, all sections in the overlay group share the same run-time address.

For each input section within the overlay the linker automatically defines two symbols. The symbol `_lc_cb_section_name` is defined as the load-time start address of the section. The symbol `_lc_ce_section_name` is defined as the load-time end address of the section. C (or assembly) code may be used to copy the overlaid sections.

If sections in the overlay group contain references between groups, the linker reports an error. The keyword **allow_cross_references** tells the linker to accept cross-references. Normally, it does not make sense to have references between sections that are overlaid.

```
group ovl (overlay)
{
    group a
    {
        select "my_ovl_p1";
        select "my_ovl_p2";
    }
    group b
    {
        select "my_ovl_q1";
    }
}
```

It may be possible that one of the sections in the overlay group already has been defined in another group where it received a load-time address. In this case the linker does not overrule this load-time address and excludes the section from the overlay group.

3. Restrict the possible addresses for the sections in a group.

The load-time address specifies where the group's elements are loaded in memory at download time. The run-time address specifies where sections are located at run-time, that is when the program is executing. If you do not explicitly restrict the address in the LSL file, the linker assigns addresses to the sections based on the restrictions relative to other sections in the LSL file and section alignments. The program is responsible for copying overlay sections at appropriate moment from its load-time location to its run-time location (this is typically done by the startup code).

- The **run_addr** keyword defines the run-time address. If the run-time location of a group is set explicitly, the given order between groups specify whether the run-time address propagates to the parent group or not. The location of the sections in a group can be restricted either to a single absolute address, or to a number of address ranges (not including the end address). With an expression you can specify that the group should be located at the absolute address specified by the expression:

```
group (run_addr = 0xa00f0000)
```

If the group is ordered, the first section in the group is located at the specified absolute address.

You can use the '[*offset*]' variant to locate the group at the given absolute offset in memory:

```
group (run_addr = mem:A[0x1000])
```

If the group is ordered, the first section in the group is located at the specified absolute offset in memory.

A range can be an absolute space address range, written as [*expr* .. *expr*], a complete memory device, written as **mem:mem_name**, or a memory address range, **mem:mem_name[*expr* .. *expr*]**

```
group (run_addr = mem:my_dram)
```

You can use the '|' to specify an address range of more than one physical memory device:

```
group (run_addr = mem:A | mem:B)
```

When used in top-level section layouts, a memory name refers to a board-level memory. You can select on-chip memory with **mem:proc_name:mem_name**. If the memory has multiple parallel mappings towards the current address space, you can select a specific named mapping in the memory by appending */map_name* to the memory specifier. The linker then maps memory offsets only through that mapping, so the address(es) where the sections in the group are located are determined by that memory mapping.

```
group (run_addr = mem:CPU1:A/cached)
```

- The **load_addr** keyword changes the meaning of the section selection in the group: the linker selects the load-time ROM copy of the named section(s) instead of the regular sections. Just like **run_addr** you can specify an absolute address or an address range.

```
group (contiguous, load_addr)
{
    select "mydata"; // select ROM copy of mydata:
                    // "[mydata]"
}
```

The load-time and run-time addresses of a group cannot be set at the same time. If the load-time property is set for a group, the group (only) restricts the positioning at load-time of the group's sections. It is not possible to set the address of a group that has a not-unrestricted parent group.

The properties of the load-time and run-time start address are:

- At run-time, before using an element in an overlay group, the application copies the sections from their load location to their run-time location, but only if these two addresses are different. For non-overlay sections this happens at program start-up.
- The start addresses cannot be set to absolute values for unrestricted groups.
- For non-overlay groups that do not have an overlay parent, the load-time start address equals the run-time start address.
- For any group, if the run-time start address is not set, the linker selects an appropriate address.

- If an ordered group or sequential group has an absolute address and contains sections that have separate page restrictions (not defined in LSL), all those sections are located in a single page. In other cases, for example when an unrestricted group has an address range assigned to it, the paged sections may be located in different pages.

For overlays, the linker reserves memory at the run-time start address as large as the largest element in the overlay group.

- The **page** keyword tells the linker to place the group in one page. Instead of specifying a run-time address, you can specify a page and optional a page number. Page numbers start from zero. If you omit the page number, the linker chooses a page.

The **page** keyword refers to pages in the address space as defined in the architecture definition.

- With the **page_size** keyword you can override the page alignment and size set on the address space. When you set the page size to zero, the linker removes simple (auto generated) page restrictions from the selected sections. See also the **page_size** keyword in [Section 17.4.3, Defining Address Spaces](#).
- With the **priority** keyword you can change the order in which sections are located. This is useful when some sections are considered important for good performance of the application and a small amount of fast memory is available. The value is a number for which the default is 1, so higher priorities start at 2. Sections with a higher priority are located before sections with a lower priority, unless their relative locate priority is already determined by other restrictions like **run_addr** and **page**.

```
group (priority=2)
{
    select "importantcode1";
    select "importantcode2";
}
```

17.8.3. Creating or Modifying Special Sections

Instead of selecting sections, you can also create a reserved section or an output section or modify special sections like a stack or a heap. Because you cannot define these sections in the input files, you must use the linker to create them.

Stack

- The keyword **stack** tells the linker to reserve memory for the stack. The name for the stack section refers to the stack as defined in the architecture definition. If no name was specified in the architecture definition, the default name is **stack**.

With the keyword **size** you can specify the size for the stack. If the size is not specified, the linker uses the size given by the **min_size** argument as defined for the stack in the architecture definition. Normally the linker automatically tries to maximize the size, unless you specified the keyword **fixed**.

```
group ( ... )
{
```

```
    stack "mystack" ( size = 2k );  
}
```

The linker creates two labels to mark the begin and end of the stack, `_lc_ub_stack_name` for the begin of the stack and `_lc_ue_stack_name` for the end of the stack. The linker allocates space for the stack when there is a reference to either of the labels.

See also the `stack` keyword in [Section 17.4.3, Defining Address Spaces](#).

Heap

- The keyword `heap` tells the linker to reserve a dynamic memory range for the `malloc()` function. Each heap section has a name. With the keyword `size` you can change the size for the heap. If the `size` is not specified, the linker uses the size given by the `min_size` argument as defined for the heap in the architecture definition. Normally the linker automatically tries to maximize the size, unless you specified the keyword `fixed`.

```
group ( ... )  
{  
    heap "myheap" ( size = 2k );  
}
```

The linker creates two labels to mark the begin and end of the heap, `_lc_ub_heap_name` for the begin of the heap and `_lc_ue_heap_name` for the end of the heap. The linker allocates space for the heap when a reference to either of the section labels exists in one of the input object files.

Reserved section

- The keyword `reserved` tells the linker to create an area or section of a given size. The linker will not locate any other sections in the memory occupied by a reserved section, with some exceptions. Each reserved section has a name. With the keyword `size` you can specify a size for a given reserved area or section.

```
group ( ... )  
{  
    reserved "myreserved" ( size = 2k );  
}
```

The optional `fill` field contains a bit pattern that the linker writes to all memory addresses that remain unoccupied during the locate process. The result of the expression, or list of expressions, is used as values to write to memory, each in MAU. The first MAU of the fill pattern is always the first MAU in the section.

By default, no sections can overlap with a reserved section. With `alloc_allowed=absolute` sections that are located at an absolute address due to an absolute group restriction can overlap a reserved section. The same applies for reserved sections with `alloc_allowed=ranged` set. Sections restricted to a fixed address range can also overlap a reserved section.

With the `attributes` field you can set the access type of the reserved section. The linker locates the reserved section in its space with the restrictions that follow from the used attributes, `r`, `w` or `x` or a valid

combination of them. The allowed attributes are shown in the following table. A value between < and > in the table means this value is set automatically by the linker.

Properties set in LSL		Resulting section properties		
attributes	filled	access	memory	content
x	yes		<rom>	executable
r	yes	r	<rom>	data
r	no	r	<rom>	scratch
rx	yes	r	<rom>	executable
rw	yes	rw	<ram>	data
rw	no	rw	<ram>	scratch
rxw	yes	rw	<ram>	executable

```
group ( ... )
{
    reserved "myreserved" ( size = 2k,
                           attributes = rw, fill = 0xaa );
}
```

If you do not specify any attributes, the linker will reserve the given number of maus, no matter what type of memory lies beneath. If you do not specify a fill pattern, no section is generated.

The linker creates two labels to mark the begin and end of the section, `_1c_ub_name` for the begin of the section and `_1c_ue_name` for the end of the reserved section.

Output sections

- The keyword `section` tells the linker to accumulate sections obtained from object files ("input sections") into an output section of a fixed size in the locate phase. You can select the input sections with `select` statements. You can use groups inside output sections, but you can only set the `align`, `attributes`, `copy` and `load_addr` properties and the `load_addr` property cannot have an address specified.

The `fill` field contains a bit pattern that the linker writes to all unused space in the output section. When all input sections have an image (code/data) you must specify a fill pattern. If you do not specify a fill pattern, all input sections must be scratch sections. The fill pattern is aligned at the start of the output section.

As with a reserved section you can use the `attributes` field to set the access type of the output section.

```
group ( ... )
{
    section "myoutput" ( size = 4k, attributes = rw,
                       fill = 0xaa )
    {
        select "myinput1";
        select "myinput2";
    }
}
```

```
    }  
}
```

The available room for input sections is determined by the **size**, **blocksize** and **overflow** fields. With the keyword **size** you specify the fixed size of the output section. Input sections are placed from output section start towards higher addresses (offsets). When the end of the output section is reached and one or more input sections are not yet placed, an error is emitted. If however, the **overflow** field is set to another output section, remaining sections are located as if they were selected for the overflow output section.

```
group ( ... )  
{  
    section "tsk1_data" (size=4k, attributes=rw, fill=0,  
                       overflow = "overflow_data")  
    {  
        select ".data.tsk1.*"  
    }  
    section "tsk2_data" (size=4k, attributes=rw, fill=0,  
                       overflow = "overflow_data")  
    {  
        select ".data.tsk2.*"  
    }  
    section "overflow_data" (size=4k, attributes=rx,  
                            fill=0)  
    {  
    }  
}
```

With the keyword **blocksize**, the size of the output section will adapt to the size of its content. For example:

```
group flash_area (run_addr = 0x10000)  
{  
    section "flash_code" (blocksize=4k, attributes=rx,  
                        fill=0)  
    {  
        select "/*.flash";  
    }  
}
```

If the content of the section is 1 mau, the size will be 4 kB, if the content is 11 kB, the section will be 12 kB, etc. If you use **size** in combination with **blocksize**, the **size** value is used as default (minimal) size for this section. If it is omitted, the default size will be of **blocksize**. It is not allowed to omit both **size** and **blocksize** from the section definition.

The linker creates two labels to mark the begin and end of the section, **_1c_ub_name** for the begin of the section and **_1c_ue_name** for the end of the output section.

When the **copy** property is set on an enclosing group, a ROM copy is created for the output section and the output section itself is made writable causing it to be located in RAM by default. For this to

work, the output section and its input sections must be read-only and the output section must have a `fill` property.

Copy table

- The keyword `copytable` tells the linker to select a section that is used as *copy table*. The content of the copy table is created by the linker. It contains the start address and length of all sections that should be initialized by the startup code.

The linker creates two labels to mark the begin and end of the section, `_1c_ub_table` for the begin of the section and `_1c_ue_table` for the end of the copy table. The linker generates a copy table when a reference to either of the section labels exists in one of the input object files.

Structures

- A `struct` statement in a `section_layout` creates a section and fills it with numbers that each occupy one or more MAUs. The new section must be named by providing a double-quoted string after the `struct` keyword. Each element has the form `expr: number;`, where the expression provides the value to insert in the section and the number determines the number of MAUs occupied by the expression value. Elements are placed in the section in the order in which they appear in the `struct` body without any gaps between them. Multi-MAU elements are split into MAUs according to the endianness of the target. A `struct` section is read-only and it cannot be copied to RAM at startup (using the `copy` group attribute). No default alignment is set.

For example,

```
struct "mystruct"
{
    0x1234                : 2;
    addressof( mem:foo )  : 4;
    addressof( mem:foo ) + sizeof( mem:foo ) : 4;
    checksum( crc32w,
        addressof( mem:foo ),
        addressof( mem:foo ) + sizeof( mem:foo ) ) : 4}
}
```

17.8.4. Creating Symbols

You can tell the linker to create symbols before locating by putting assignments in the section layout definition. Symbol names are represented by double-quoted strings. Any string is allowed, but object files may not support all characters for symbol names. You can use two different assignment operators. With the simple assignment operator `=`, the symbol is created unconditionally. With the `:=` operator, the symbol is only created if it already exists as an undefined reference in an object file.

The expression that represents the value to assign to the symbol may contain references to other symbols. If such a referred symbol is a special section symbol, creation of the symbol in the left hand side of the assignment will cause creation of the special section.

```
section_layout
{
```

```
"_lc_bs" := "_lc_ub_stack";  
  // when the symbol _lc_bs occurs as an undefined reference  
  // in an object file, the linker allocates space for the stack  
}
```

17.8.5. Conditional Group Statements

Within a group, you can conditionally select sections or create special sections.

- With the **if** keyword you can specify a condition. The succeeding section statement is executed if the condition evaluates to TRUE (1).
- The optional **else** keyword is followed by a section statement which is executed in case the if-condition evaluates to FALSE (0).

```
group ( ... )  
{  
  if ( exists( "mysection" ) )  
    select "mysection";  
  else  
    reserved "myreserved" ( size=2k );  
}
```

Chapter 18. Debug Target Configuration Files

DTC files (Debug Target Configuration files) define all possible configurations for a debug target. A debug target can be target hardware such as an evaluation board or a simulator. The DTC files are used by Eclipse to configure the project and the debugger. The information is used by the Target Board Configuration wizard and the debug configuration. DTC files are located in the `etc` directory of the installed product and use `.dtc` as filename suffix.

Based on the DTC files, the Target Board Configuration wizard adjust the project's LSL file and creates a debug launch configuration.

18.1. Custom Board Support

When you need support for a custom board and the board requires a different configuration than those that are in the product, it is necessary to create a dedicated DTC file.

To add a custom board

1. From the `etc` directory of the product, make a copy of a `.dtc` file and put it in your project directory (in the current workspace).

In Eclipse, the DTC file should now be visible as part of your project.

2. Edit the file and give it a name that reflects the custom board.

The Import Board Configuration wizard in Eclipse adds DTC files that are present in your current project to the list of available target boards.

Syntax of a DTC file

DTC files are XML files and use the XML Schema file `dtc.xsd`, also present in the `etc` directory of the installed product.

Inspect the DTC XML schema file `dtc.xsd` for a description of the allowed elements and the available attributes. Use a delivered `.dtc` file as a starting point for creating a custom board specification.

Basically a DTC file consists of the definition of the debug target (`debugTarget` element) which embodies one or more configurations (`configuration` element) and one or more communication methods (`communicationMethod` element). The Import Board Configuration wizard in Eclipse reflects the structure of the DTC file. The elements that determine the settings that are applied by the wizard, can be found at any level in the DTC file. The wizard will apply all elements that are within the path to the selected configuration. This is best explained by an example of a DTC file with the following basic layout:

```
debugTarget: STMicroelectronics STM3210B-Eval board
  lsl
  configuration: Default
    lsl
  communicationMethod: J-Link over USB (JTAG)
```

lsl

If, in the Import Board Configuration wizard in Eclipse, you set the board configuration to "J-Link-ARM", the wizard puts the following LSL parts into the project's LSL file in this order:

- the lsl part under the debugTarget element
- the lsl part under the communicationMethod "J-Link over USB" element
- the lsl part under the configuration "J-Link-ARM" in the communicationMethod "J-Link over USB" element
- the lsl part in the debugTarget element at the end of the DTC file

The same applies to all other elements that determine the underlying settings.

DTC macros in LSL

To protect the Target Board Configuration wizard from changing the LSL file, you can protect the LSL file by adding the macro `__DTC_IGNORE`. This can be useful for projects that need the same LSL file, but still need to run on different target boards.

```
#define __DTC_IGNORE
```

18.2. Description of DTC Elements and Attributes

The following table contains a description of the DTC elements and attributes. For each element a list of allowed elements is listed and the available attributes are described.

Element / Attribute	Description	Allowed Elements
debugTarget	The debug target.	flashChips, lsl, communicationMethod, def, processor, resource, initialize
name	The name of the configuration.	
manufacturer	The manufacturer of the debug target.	
processor	Defines a processor that can be present on the debug target. Multiple processor definitions are allowed. The user should select the actual processor on the debug target.	-
name	A descriptive name of the processor derivative.	
cpu	Defines the CPU name, as for example supplied with the option <code>--cpu</code> of the C compiler.	
communicationMethod	Defines a communication method. A communication method is the channel that is used to communicate with the target.	ref, resource, initialize, configuration, lsl, processor

Element / Attribute	Description	Allowed Elements
name	A descriptive name of the communication method.	
debugInstrument	The debug instrument DLL/Shared library file to be used for this communication method. Do not supply a path or a filename suffix.	
gdiMethod	This is the method used for communication. Allowed values: rs232, tcpip, can, none	
def	Defines a set of elements as a macro. The macro can be expanded using the <code>ref</code> element.	Isl, resource, initialize, ref, configuration, flashMonitor
id	The macro name.	
resource	Defines a resource definition that can be used by Eclipse, the debugger or by the debug instrument.	-
id	The identifier name used by the debugger or debug instrument to retrieve the value.	
value	The value assigned to the resource.	
ref	Reference to a macro defined with a <code>def</code> element. The elements contained in the <code>def</code> element with the same name will be expanded at the location of the <code>ref</code> . Multiple <code>refs</code> to the same <code>def</code> are allowed.	-
id	The name of the referenced macro.	
configuration	Defines a configuration.	ref, initialize, resource, Isl, flashMonitor, processor
name	The descriptive name of the configuration.	
initialize	This element defines an initialization expression. Each initialize element contains a <code>resourceId</code> attribute. If the DI requests this resource the debugger will compose a string from all initialize elements with the same <code>resourceId</code> . This DI can use this string to initialize registers by passing it to the debugger as an expression to be evaluated.	-
resourceId	The name of the resource to be used.	
name	The name of the register to be initialized.	
value	When the <code>cstart</code> attribute is false, this is the value to be used, otherwise, it is the default value when using this configuration. It will be used by the startup code editor to set the default register values.	

Element / Attribute	Description	Allowed Elements
cstart	A boolean value. If true the debugger should ask the C startup code editor for the value, otherwise the contents of the value attribute is used. The default value is true.	
flashMonitor	This element specifies the flash programming monitor to be used for this configuration.	-
monitor	Filename of the monitor, usually an Intel Hex or S-Record file.	
workspaceAddress	The address of the workspace of the flash programming monitor.	
flashSectorBufferSize	Specifies the buffer size for buffering a flash sector.	
chip	This element defines a flash chip. It must be used by the flash properties page to add it on request to the list of flash chips.	debugTarget
vendor	The vendor of this flash chip.	
chip	The name of the chip.	
width	The width of the chip in bits.	
chips	The number of chips present on the board.	
baseAddress	The base address of the chip.	
chipSize	The size of the chip in bytes.	
flashChips	Specify a list of flash chips that can be available on this debug target.	chip
lsl	Defines LSL pieces belonging to the configuration part. The LSL text must be defined between the start and end tag of this element. All LSL texts of the active selection will be placed in the project's LSL file.	-

18.3. Special Resource Identifiers

The following resource IDs are available in the TASKING VX-toolset for ARM:

J-Link debug instrument (DI): dijlinkarm

Resource Name	Description
arm.luminary.clockrate	Clock rate in Hz. Necessary for the initialization of register USECRL.

ST-Link debug instrument (DI): distlink

Resource Name	Description
distlink.protocol	The interface for using ST-Link. Can be JTAG or SWD.

Chapter 19. CPU Problem Bypasses and Checks

ARM publishes errata sheets for reporting both CPU core functional problems and deviations from the electrical and timing specifications.

For some of these functional problems in the CPU core itself, the TASKING VX-toolset for ARM compiler provides workarounds. In fact these are software workarounds for hardware problems.

This chapter lists a summary of functional problems which can be bypassed by the compiler toolset. Please refer to the ARM errata sheets for the CPU core you are using, to verify if you need to use one of these bypasses.

To set a CPU bypass or check

1. From the **Project** menu, select **Properties for**

The Properties dialog appears.

2. In the left pane, expand **C/C++ Build** and select **Processor**.

In the right pane the Processor page appears.

3. From the **Processor selection** list, select a processor.

*The **CPU problem bypasses and checks** box shows the available workarounds/checks available for the selected processor.*

4. (Optional) Select **Show all CPU problem bypasses and checks**.

5. Click **Select All** or select one or more individual options.

Overview of the CPU problem bypasses and checks

The following table contains an overview of the silicon bug numbers you can provide to the compiler and assembler option **--silicon-bug**. WA means a workaround by the compiler, WL means a workaround by the linker, CK means a check by the assembler.

Number	Description	Workaround	Check	CPU
602117	LDRD with base in list may result in incorrect base register when interrupted or faulted	WA	CK	Cortex-M3 / Cortex-M3 with ETM
752419 752770	LDR SP, mem may result in incorrect SP when interrupted	WA	CK	Cortex-M3 / Cortex-M3 with ETM / Cortex-M4 / Cortex-M4 with FPU
pmc_cm_001	The use of BX LR for return from interrupt may trigger a prefetch problem	WL		XMC4000 family

602117 -- LDRD with base in list may result in incorrect base register when interrupted or faulted

ARM reference

602117

Command line option

`--silicon-bug=602117`

Description

In the Cortex-M3 or Cortex-M3 with ETM the LDRD instruction with the base register in the list of the form `LDRD Ra, Rb, [Ra, #imm]` may not complete after the load of the first destination register due to an interrupt before the completion of the second load or due to the second load getting a bus fault or an MPU fault. When you use the C compiler option `--silicon-bug=602117` the compiler will replace the LDRD instruction by an ADD instruction and two LDR instructions which will produce exactly the same functionality:

```
ADD R12, Ra, #imm
LDR Ra, [R12, #0]
LDR Rb, [R12, #4]
```

When you use the assembler option `--silicon-bug=602117`, the assembler issues a warning when the 602117 problem is present.

Related information

[ARM Core Cortex-M3 - Errata Notice](#)

752419 / 752770 -- LDR SP, mem may result in incorrect SP when interrupted

ARM reference

752419 and 752770

Command line option

```
--silicon-bug=752419  
--silicon-bug=752770
```

Description

In the Cortex-M3, Cortex-M3 with ETM Cortex-M4 and Cortex-M4 with FPU interrupted loads to SP can cause erroneous behavior. In the compiler the problem only occurs when the `__setsp()` intrinsic is used, or when VLAs are used (via the `__free()` intrinsic). When you use the C compiler option **--silicon-bug=752419** the compiler generates alternate code in these instances and enough optimizations are blocked for these specific bits of code so that the suspected instructions should not be admitted.

When you use the assembler option **--silicon-bug=752419**, the assembler issues a warning when the 752419 problem is present. It is recommended to enable the assembler check for this silicon problem as well to be sure the suspected instructions will never be generated.

Option **--silicon-bug=752770** is an alias for **--silicon-bug=752419**.

Related information

[ARM Core Cortex-M3 - Errata Notice](#)

[ARM Core Cortex-M4 - Errata Notice](#)

pmc_cm_001 -- The use of BX LR for return from interrupt may trigger a prefetch problem

Infineon reference

PMU_CM.001

Command line option

`--silicon-bug=pmc_cm_001`

Description

In the XMC4000 family a branch from a non-cacheable to a cacheable address space instruction may corrupt the program execution. When you use the control program option `--silicon-bug=pmc_cm_001` the control program passes the option `-DSILICON_BUG_PMC_CM_001` to the linker. To bypass this CPU functional problem, the preprocessor define `SILICON_BUG_PMC_CM_001` is used in the `xmc4*.lsl` linker script files. The vector table is defined in such a way that the interrupt functions are called via a veneer which returns by using `PUSH LR, POP PC` instead of `BX LR`.

Related information

[Infineon XMC4000 Documents - Errata Sheet](#)

Chapter 20. CERT C Secure Coding Standard

The CERT C Secure Coding Standard provides rules and recommendations for secure coding in the C programming language. The goal of these rules and recommendations is to eliminate insecure coding practices and undefined behaviors that can lead to exploitable vulnerabilities. The application of the secure coding standard will lead to higher-quality systems that are robust and more resistant to attack.

This chapter contains an overview of the CERT C Secure Coding Standard recommendations and rules that are supported by the TASKING VX-toolset.

For details see the [CERT C Secure Coding Standard](#) web site. For general information about CERT secure coding, see www.cert.org/secure-coding.

Identifiers

Each rule and recommendation is given a unique identifier. These identifiers consist of three parts:

- a three-letter mnemonic representing the section of the standard
- a two-digit numeric value in the range of 00-99
- the letter "C" indicates that this is a C language guideline

The three-letter mnemonic is used to group similar coding practices and to indicate to which category a coding practice belongs.

The numeric value is used to give each coding practice a unique identifier. Numeric values in the range of 00-29 are reserved for recommendations, while values in the range of 30-99 are reserved for rules.

C compiler invocation

With the C compiler option `--cert` you can enable one or more checks for the CERT C Secure Coding Standard recommendations/rules. With `--diag=cert` you can see a list of the available checks, or you can use a three-letter mnemonic to list only the checks in a particular category. For example, `--diag=pre` lists all supported checks in the preprocessor category.

20.1. Preprocessor (PRE)

PRE01-C Use parentheses within macros around parameter names

Parenthesize all parameter names in macro definitions to avoid precedence problems.

PRE02-C Macro replacement lists should be parenthesized

Macro replacement lists should be parenthesized to protect any lower-precedence operators from the surrounding expression. The example below is syntactically correct, although the `!=` operator was omitted. Enclosing the constant `-1` in parenthesis will prevent the incorrect interpretation and force a compiler error:

```
#define EOF -1 // should be (-1)
int getchar(void);
void f(void)
{
    if (getchar() EOF) // != operator omitted
    {
        /* ... */
    }
}
```

PRE10-C Wrap multi-statement macros in a do-while loop

When multiple statements are used in a macro, enclose them in a `do-while` statement, so the macro can appear safely inside `if` clauses or other places that expect a single statement or a statement block. Braces alone will not work in all situations, as the macro expansion is typically followed by a semicolon.

PRE11-C Do not conclude a single statement macro definition with a semicolon

Macro definitions consisting of a single statement should not conclude with a semicolon. If required, the semicolon should be included following the macro expansion. Inadvertently inserting a semicolon can change the control flow of the program.

20.2. Declarations and Initialization (DCL)

DCL30-C Declare objects with appropriate storage durations

The lifetime of an automatic object ends when the function returns, which means that a pointer to the object becomes invalid.

DCL31-C Declare identifiers before using them

The ISO C90 standard allows implicit typing of variables and functions. Because implicit declarations lead to less stringent type checking, they can often introduce unexpected and erroneous behavior or even security vulnerabilities. The ISO C99 standard requires type identifiers and forbids implicit function declarations. For backwards compatibility reasons, the VX-toolset C compiler assumes an implicit declaration and continues translation after issuing a warning message (W505 or W535).

DCL32-C Guarantee that mutually visible identifiers are unique

The compiler encountered two or more identifiers that are identical in the first 31 characters. The ISO C99 standard allows a compiler to ignore characters past the first 31 in an identifier. Two distinct identifiers that are identical in the first 31 characters may lead to problems when the code is ported to a different compiler.

DCL35-C Do not invoke a function using a type that does not match the function definition

This warning is generated when a function pointer is set to refer to a function of an incompatible type. Calling this function through the function pointer will result in undefined behavior. Example:

```
void my_function(int a);
int main(void)
{
    int (*new_function)(int a) = my_function;
    return (*new_function)(10); /* the behavior is undefined */
}
```

20.3. Expressions (EXP)

EXP01-C Do not take the size of a pointer to determine the size of the pointed-to type

The size of the object(s) allocated by `malloc()`, `calloc()` or `realloc()` should be a multiple of the size of the base type of the result pointer. Therefore, the `sizeof` expression should be applied to this base type, and not to the pointer type.

EXP12-C Do not ignore values returned by functions

The compiler gives this warning when the result of a function call is ignored at some place, although it is not ignored for other calls to this function. This warning will not be issued when the function result is ignored for all calls, or when the result is explicitly ignored with a `(void)` cast.

EXP30-C Do not depend on order of evaluation between sequence points

Between two sequence points, an object should only be modified once. Otherwise the behavior is undefined.

EXP32-C Do not access a volatile object through a non-volatile reference

If an attempt is made to refer to an object defined with a volatile-qualified type through use of an lvalue with non-volatile-qualified type, the behavior is undefined.

EXP33-C Do not reference uninitialized memory

Uninitialized automatic variables default to whichever value is currently stored on the stack or in the register allocated for the variable. Consequently, uninitialized memory can cause a program to behave in an unpredictable or unplanned manner and may provide an avenue for attack.

EXP34-C Ensure a null pointer is not dereferenced

Attempting to dereference a null pointer results in undefined behavior, typically abnormal program termination.

EXP37-C Call functions with the arguments intended by the API

When a function is properly declared with function prototype information, an incorrect call will be flagged by the compiler. When there is no prototype information available at the call, the compiler cannot check the number of arguments and the types of the arguments. This message is issued to warn about this situation.

EXP38-C Do not call `offsetof()` on bit-field members or invalid types

The behavior of the `offsetof()` macro is undefined when the member designator parameter designates a bit-field.

20.4. Integers (INT)

INT30-C Ensure that unsigned integer operations do not wrap

A constant with an unsigned integer type is truncated, resulting in a wrap-around.

INT34-C Do not shift a negative number of bits or more bits than exist in the operand

The shift count of the shift operation may be negative or greater than or equal to the size of the left operand. According to the C standard, the behavior of such a shift operation is undefined. Make sure the shift count is in range by adding appropriate range checks.

INT35-C Evaluate integer expressions in a larger size before comparing or assigning to that size

If an integer expression is compared to, or assigned to a larger integer size, that integer expression should be evaluated in that larger size by explicitly casting one of the operands.

20.5. Floating Point (FLP)

FLP30-C Do not use floating point variables as loop counters

To avoid problems with limited precision and rounding, floating point variables should not be used as loop counters.

FLP35-C Take granularity into account when comparing floating point values

Floating point arithmetic in C is inexact, so floating point values should not be tested for exact equality or inequality.

FLP36-C Beware of precision loss when converting integral types to floating point

Conversion from integral types to floating point types without sufficient precision can lead to loss of precision.

20.6. Arrays (ARR)

ARR01-C Do not apply the sizeof operator to a pointer when taking the size of an array

A function parameter declared as an array, is converted to a pointer by the compiler. Therefore, the sizeof operator applied to this parameter yields the size of a pointer, and not the size of an array.

ARR34-C Ensure that array types in expressions are compatible

Using two or more incompatible arrays in an expression results in undefined behavior.

ARR35-C Do not allow loops to iterate beyond the end of an array

Reading or writing of data outside the bounds of an array may lead to incorrect program behavior or execution of arbitrary code.

20.7. Characters and Strings (STR)

STR30-C Do not attempt to modify string literals

Writing to a string literal has undefined behavior, as identical strings may be shared and/or allocated in read-only memory.

STR33-C Size wide character strings correctly

Wide character strings may be improperly sized when they are mistaken for narrow strings or for multi-byte character strings.

STR34-C Cast characters to unsigned types before converting to larger integer sizes

A signed character is sign-extended to a larger signed integer value. Use an explicit cast, or cast the value to an unsigned type first, to avoid unexpected sign-extension.

STR36-C Do not specify the bound of a character array initialized with a string literal

The compiler issues this warning when the character buffer initialized by a string literal does not provide enough room for the terminating null character.

20.8. Memory Management (MEM)

MEM00-C Allocate and free memory in the same module, at the same level of abstraction

The compiler issues this warning when the result of the call to malloc(), calloc() or realloc() is discarded, and therefore not free()d, resulting in a memory leak.

MEM08-C Use realloc() only to resize dynamically allocated arrays

Only use realloc() to resize an array. Do not use it to transform an object to an object of a different type.

MEM30-C Do not access freed memory

When memory is freed, its contents may remain intact and accessible because it is at the memory manager's discretion when to reallocate or recycle the freed chunk. The data at the freed location may appear valid. However, this can change unexpectedly, leading to unintended program behavior. As a result, it is necessary to guarantee that memory is not written to or read from once it is freed.

MEM31-C Free dynamically allocated memory exactly once

Freeing memory multiple times has similar consequences to accessing memory after it is freed. The underlying data structures that manage the heap can become corrupted. To eliminate double-free vulnerabilities, it is necessary to guarantee that dynamic memory is freed exactly once.

MEM32-C Detect and handle memory allocation errors

The result of `realloc()` is assigned to the original pointer, without checking for failure. As a result, the original block of memory is lost when `realloc()` fails.

MEM33-C Use the correct syntax for flexible array members

Use the ISO C99 syntax for flexible array members instead of an array member of size 1.

MEM34-C Only free memory allocated dynamically

Freeing memory that is not allocated dynamically can lead to corruption of the heap data structures.

MEM35-C Allocate sufficient memory for an object

The compiler issues this warning when the size of the object(s) allocated by `malloc()`, `calloc()` or `realloc()` is smaller than the size of an object pointed to by the result pointer. This may be caused by a `sizeof` expression with the wrong type or with a pointer type instead of the object type.

20.9. Environment (ENV)

ENV32-C All `atexit` handlers must return normally

The compiler issues this warning when an `atexit()` handler is calling a function that does not return. No `atexit()` registered handler should terminate in any way other than by returning.

20.10. Signals (SIG)

SIG30-C Call only asynchronous-safe functions within signal handlers

SIG32-C Do not call `longjmp()` from inside a signal handler

Invoking the `longjmp()` function from within a signal handler can lead to undefined behavior if it results in the invocation of any non-asynchronous-safe functions, likely compromising the integrity of the program.

20.11. Miscellaneous (MSC)

MSC32-C Ensure your random number generator is properly seeded

Ensure that the random number generator is properly seeded by calling `srand()`.

Chapter 21. MISRA C Rules

This chapter contains an overview of the supported and unsupported MISRA C rules.

21.1. MISRA C:1998

This section lists all supported and unsupported MISRA C:1998 rules.

See also [Section 4.6.2, C Code Checking: MISRA C](#).

A number of MISRA C rules leave room for interpretation. Other rules can only be checked in a limited way. In such cases the implementation decisions and possible restrictions for these rules are listed.

x means that the rule is not supported by the TASKING C compiler. (R) is a required rule, (A) is an advisory rule.

1. (R) The code shall conform to standard C, without language extensions.
- x** 2. (A) Other languages should only be used with an interface standard.
3. (A) Inline assembly is only allowed in dedicated C functions.
- x** 4. (A) Provision should be made for appropriate run-time checking.
5. (R) Only use characters and escape sequences defined by ISO C.
- x** 6. (R) Character values shall be restricted to a subset of ISO 10646-1.
7. (R) Trigraphs shall not be used.
8. (R) Multibyte characters and wide string literals shall not be used.
9. (R) Comments shall not be nested.
10. (A) Sections of code should not be "commented out".

In general, it is not possible to decide whether a piece of comment is C code that is commented out, or just some pseudo code. Instead, the following heuristics are used to detect possible C code inside a comment:

- a line ends with ';', or
- a line starts with '}', possibly preceded by white space

11. (R) Identifiers shall not rely on significance of more than 31 characters.
12. (A) The same identifier shall not be used in multiple name spaces.
13. (A) Specific-length typedefs should be used instead of the basic types.
14. (R) Use `unsigned char` or `signed char` instead of plain `char`.
- x** 15. (A) Floating-point implementations should comply with a standard.
16. (R) The bit representation of floating-point numbers shall not be used.
A violation is reported when a pointer to a floating-point type is converted to a pointer to an integer type.

TASKING VX-toolset for ARM User Guide

17. (R) `typedef` names shall not be reused.
18. (A) Numeric constants should be suffixed to indicate type.
A violation is reported when the value of the constant is outside the range indicated by the suffixes, if any.
19. (R) Octal constants (other than zero) shall not be used.
20. (R) All object and function identifiers shall be declared before use.
21. (R) Identifiers shall not hide identifiers in an outer scope.
22. (A) Declarations should be at function scope where possible.
- x 23. (A) All declarations at file scope should be static where possible.
24. (R) Identifiers shall not have both internal and external linkage.
- x 25. (R) Identifiers with external linkage shall have exactly one definition.
26. (R) Multiple declarations for objects or functions shall be compatible.
- x 27. (A) External objects should not be declared in more than one file.
28. (A) The `register` storage class specifier should not be used.
29. (R) The use of a tag shall agree with its declaration.
30. (R) All automatics shall be initialized before being used .
This rule is checked using worst-case assumptions. This means that violations are reported not only for variables that are guaranteed to be uninitialized, but also for variables that are uninitialized on some execution paths.
31. (R) Braces shall be used in the initialization of arrays and structures.
32. (R) Only the first, or all enumeration constants may be initialized.
33. (R) The right hand operand of `&&` or `||` shall not contain side effects.
34. (R) The operands of a logical `&&` or `||` shall be primary expressions.
35. (R) Assignment operators shall not be used in Boolean expressions.
36. (A) Logical operators should not be confused with bitwise operators.
37. (R) Bitwise operations shall not be performed on signed integers.
38. (R) A shift count shall be between 0 and the operand width minus 1.
This violation will only be checked when the shift count evaluates to a constant value at compile time.
39. (R) The unary minus shall not be applied to an unsigned expression.
40. (A) `sizeof` should not be used on expressions with side effects.
- x 41. (A) The implementation of integer division should be documented.
42. (R) The comma operator shall only be used in a `for` condition.
43. (R) Don't use implicit conversions which may result in information loss.
44. (A) Redundant explicit casts should not be used.
45. (R) Type casting from any type to or from pointers shall not be used.

46. (R) The value of an expression shall be evaluation order independent. This rule is checked using worst-case assumptions. This means that a violation will be reported when a possible alias may cause the result of an expression to be evaluation order dependent.
47. (A) No dependence should be placed on operator precedence rules.
48. (A) Mixed arithmetic should use explicit casting.
49. (A) Tests of a (non-Boolean) value against 0 should be made explicit.
50. (R) F.P. variables shall not be tested for exact equality or inequality.
51. (A) Constant unsigned integer expressions should not wrap-around.
52. (R) There shall be no unreachable code.
53. (R) All non-null statements shall have a side-effect.
54. (R) A null statement shall only occur on a line by itself.
55. (A) Labels should not be used.
56. (R) The `goto` statement shall not be used.
57. (R) The `continue` statement shall not be used.
58. (R) The `break` statement shall not be used (except in a `switch`).
59. (R) An `if` or loop body shall always be enclosed in braces.
60. (A) All `if, else if` constructs should contain a final `else`.
61. (R) Every non-empty `case` clause shall be terminated with a `break`.
62. (R) All `switch` statements should contain a final `default` case.
63. (A) A `switch` expression should not represent a Boolean case.
64. (R) Every `switch` shall have at least one `case`.
65. (R) Floating-point variables shall not be used as loop counters.
66. (A) A `for` should only contain expressions concerning loop control. A violation is reported when the loop initialization or loop update expression modifies an object that is not referenced in the loop test.
67. (A) Iterator variables should not be modified in a `for` loop.
68. (R) Functions shall always be declared at file scope.
69. (R) Functions with variable number of arguments shall not be used.
70. (R) Functions shall not call themselves, either directly or indirectly. A violation will be reported for direct or indirect recursive function calls in the source file being checked. Recursion via functions in other source files, or recursion via function pointers is not detected.
71. (R) Function prototypes shall be visible at the definition and call.
72. (R) The function prototype of the declaration shall match the definition.
73. (R) Identifiers shall be given for all prototype parameters or for none.
74. (R) Parameter identifiers shall be identical for declaration/definition.
75. (R) Every function shall have an explicit return type.

TASKING VX-toolset for ARM User Guide

- 76. (R) Functions with no parameters shall have a `void` parameter list.
- 77. (R) An actual parameter type shall be compatible with the prototype.
- 78. (R) The number of actual parameters shall match the prototype.
- 79. (R) The values returned by `void` functions shall not be used.
- 80. (R) Void expressions shall not be passed as function parameters.
- 81. (A) `const` should be used for reference parameters not modified.
- 82. (A) A function should have a single point of exit.
- 83. (R) Every exit point shall have a `return` of the declared return type.
- 84. (R) For `void` functions, `return` shall not have an expression.
- 85. (A) Function calls with no parameters should have empty parentheses.
- 86. (A) If a function returns error information, it should be tested.
A violation is reported when the return value of a function is ignored.
- 87. (R) `#include` shall only be preceded by other directives or comments.
- 88. (R) Non-standard characters shall not occur in `#include` directives.
- 89. (R) `#include` shall be followed by either `<filename>` or `"filename"`.
- 90. (R) Plain macros shall only be used for constants/qualifiers/specifiers.
- 91. (R) Macros shall not be `#define`'d and `#undef`'d within a block.
- 92. (A) `#undef` should not be used.
- 93. (A) A function should be used in preference to a function-like macro.
- 94. (R) A function-like macro shall not be used without all arguments.
- 95. (R) Macro arguments shall not contain pre-preprocessing directives.
A violation is reported when the first token of an actual macro argument is `'#'`.
- 96. (R) Macro definitions/parameters should be enclosed in parentheses.
- 97. (A) Don't use undefined identifiers in pre-processing directives.
- 98. (R) A macro definition shall contain at most one `#` or `##` operator.
- 99. (R) All uses of the `#pragma` directive shall be documented.
This rule is really a documentation issue. The compiler will flag all `#pragma` directives as violations.
- 100. (R) `defined` shall only be used in one of the two standard forms.
- 101. (A) Pointer arithmetic should not be used.
- 102. (A) No more than 2 levels of pointer indirection should be used.
A violation is reported when a pointer with three or more levels of indirection is declared.
- 103. (R) No relational operators between pointers to different objects.
In general, checking whether two pointers point to the same object is impossible. The compiler will only report a violation for a relational operation with incompatible pointer types.
- 104. (R) Non-constant pointers to functions shall not be used.
- 105. (R) Functions assigned to the same pointer shall be of identical type.

- 106. (R) Automatic address may not be assigned to a longer lived object.
- 107. (R) The null pointer shall not be de-referenced.
A violation is reported for every pointer dereference that is not guarded by a NULL pointer test.
- 108. (R) All `struct/union` members shall be fully specified.
- 109. (R) Overlapping variable storage shall not be used.
A violation is reported for every `union` declaration.
- 110. (R) Unions shall not be used to access the sub-parts of larger types.
A violation is reported for a `union` containing a `struct` member.
- 111. (R) Bit-fields shall have type `unsigned int` or `signed int`.
- 112. (R) Bit-fields of type `signed int` shall be at least 2 bits long.
- 113. (R) All `struct/union` members shall be named.
- 114. (R) Reserved and standard library names shall not be redefined.
- 115. (R) Standard library function names shall not be reused.
- x 116. (R) Production libraries shall comply with the MISRA C restrictions.
- x 117. (R) The validity of library function parameters shall be checked.
- 118. (R) Dynamic heap memory allocation shall not be used.
- 119. (R) The error indicator `errno` shall not be used.
- 120. (R) The macro `offsetof` shall not be used.
- 121. (R) `<locale.h>` and the `setlocale` function shall not be used.
- 122. (R) The `setjmp` and `longjmp` functions shall not be used.
- 123. (R) The signal handling facilities of `<signal.h>` shall not be used.
- 124. (R) The `<stdio.h>` library shall not be used in production code.
- 125. (R) The functions `atof/atoi/atol` shall not be used.
- 126. (R) The functions `abort/exit/getenv/system` shall not be used.
- 127. (R) The time handling functions of library `<time.h>` shall not be used.

21.2. MISRA C:2004

This section lists all supported and unsupported MISRA C:2004 rules.

See also [Section 4.6.2, C Code Checking: MISRA C](#).

A number of MISRA C rules leave room for interpretation. Other rules can only be checked in a limited way. In such cases the implementation decisions and possible restrictions for these rules are listed.

x means that the rule is not supported by the TASKING C compiler. (R) is a required rule, (A) is an advisory rule.

Environment

- 1.1 (R) All code shall conform to ISO 9899:1990 "Programming languages - C", amended and corrected by ISO/IEC 9899/COR1:1995, ISO/IEC 9899/AMD1:1995, and ISO/IEC 9899/COR2:1996.
- 1.2 (R) No reliance shall be placed on undefined or unspecified behavior.
- ✘ 1.3 (R) Multiple compilers and/or languages shall only be used if there is a common defined interface standard for object code to which the languages/compiler/assemblers conform.
- ✘ 1.4 (R) The compiler/linker shall be checked to ensure that 31 character significance and case sensitivity are supported for external identifiers.
- ✘ 1.5 (A) Floating-point implementations should comply with a defined floating-point standard.

Language extensions

- 2.1 (R) Assembly language shall be encapsulated and isolated.
- 2.2 (R) Source code shall only use `/* . . . */` style comments.
- 2.3 (R) The character sequence `/*` shall not be used within a comment.
- 2.4 (A) Sections of code should not be "commented out". In general, it is not possible to decide whether a piece of comment is C code that is commented out, or just some pseudo code. Instead, the following heuristics are used to detect possible C code inside a comment: - a line ends with `';`, or - a line starts with `'`, possibly preceded by white space

Documentation

- ✘ 3.1 (R) All usage of implementation-defined behavior shall be documented.
- ✘ 3.2 (R) The character set and the corresponding encoding shall be documented.
- ✘ 3.3 (A) The implementation of integer division in the chosen compiler should be determined, documented and taken into account.
- 3.4 (R) All uses of the `#pragma` directive shall be documented and explained. This rule is really a documentation issue. The compiler will flag all `#pragma` directives as violations.
- 3.5 (R) The implementation-defined behavior and packing of bit-fields shall be documented if being relied upon.
- ✘ 3.6 (R) All libraries used in production code shall be written to comply with the provisions of this document, and shall have been subject to appropriate validation.

Character sets

- 4.1 (R) Only those escape sequences that are defined in the ISO C standard shall be used.
- 4.2 (R) Trigraphs shall not be used.

Identifiers

- 5.1 (R) Identifiers (internal and external) shall not rely on the significance of more than 31 characters.
- 5.2 (R) Identifiers in an inner scope shall not use the same name as an identifier in an outer scope, and therefore hide that identifier.
- 5.3 (R) A `typedef` name shall be a unique identifier.
- 5.4 (R) A tag name shall be a unique identifier.
- 5.5 (A) No object or function identifier with static storage duration should be reused.
- 5.6 (A) No identifier in one name space should have the same spelling as an identifier in another name space, with the exception of structure and union member names.
- 5.7 (A) No identifier name should be reused.

Types

- 6.1 (R) The plain `char` type shall be used only for storage and use of character values.
- 6.2 (R) `signed` and `unsigned char` type shall be used only for the storage and use of numeric values.
- 6.3 (A) `typedefs` that indicate size and signedness should be used in place of the basic types.
- 6.4 (R) Bit-fields shall only be defined to be of type `unsigned int` or `signed int`.
- 6.5 (R) Bit-fields of type `signed int` shall be at least 2 bits long.

Constants

- 7.1 (R) Octal constants (other than zero) and octal escape sequences shall not be used.

Declarations and definitions

- 8.1 (R) Functions shall have prototype declarations and the prototype shall be visible at both the function definition and call.
- 8.2 (R) Whenever an object or function is declared or defined, its type shall be explicitly stated.
- 8.3 (R) For each function parameter the type given in the declaration and definition shall be identical, and the return types shall also be identical.
- 8.4 (R) If objects or functions are declared more than once their types shall be compatible.
- 8.5 (R) There shall be no definitions of objects or functions in a header file.
- 8.6 (R) Functions shall be declared at file scope.
- 8.7 (R) Objects shall be defined at block scope if they are only accessed from within a single function.
- 8.8 (R) An external object or function shall be declared in one and only one file.

TASKING VX-toolset for ARM User Guide

- 8.9 (R) An identifier with external linkage shall have exactly one external definition.
- x 8.10 (R) All declarations and definitions of objects or functions at file scope shall have internal linkage unless external linkage is required.
- 8.11 (R) The `static` storage class specifier shall be used in definitions and declarations of objects and functions that have internal linkage.
- 8.12 (R) When an array is declared with external linkage, its size shall be stated explicitly or defined implicitly by initialization.

Initialization

- 9.1 (R) All automatic variables shall have been assigned a value before being used. This rule is checked using worst-case assumptions. This means that violations are reported not only for variables that are guaranteed to be uninitialized, but also for variables that are uninitialized on some execution paths.
- 9.2 (R) Braces shall be used to indicate and match the structure in the non-zero initialization of arrays and structures.
- 9.3 (R) In an enumerator list, the "=" construct shall not be used to explicitly initialize members other than the first, unless all items are explicitly initialized.

Arithmetic type conversions

- 10.1 (R) The value of an expression of integer type shall not be implicitly converted to a different underlying type if:
 - a) it is not a conversion to a wider integer type of the same signedness, or
 - b) the expression is complex, or
 - c) the expression is not constant and is a function argument, or
 - d) the expression is not constant and is a return expression.
- 10.2 (R) The value of an expression of floating type shall not be implicitly converted to a different type if:
 - a) it is not a conversion to a wider floating type, or
 - b) the expression is complex, or
 - c) the expression is a function argument, or
 - d) the expression is a return expression.
- 10.3 (R) The value of a complex expression of integer type may only be cast to a type of the same signedness that is no wider than the underlying type of the expression.
- 10.4 (R) The value of a complex expression of floating type may only be cast to a type that is no wider than the underlying type of the expression.
- 10.5 (R) If the bitwise operators `~` and `<<` are applied to an operand of underlying type `unsigned char` or `unsigned short`, the result shall be immediately cast to the underlying type of the operand.
- 10.6 (R) A "U" suffix shall be applied to all constants of `unsigned` type.

Pointer type conversions

- 11.1 (R) Conversions shall not be performed between a pointer to a function and any type other than an integral type.
- 11.2 (R) Conversions shall not be performed between a pointer to object and any type other than an integral type, another pointer to object type or a pointer to void.
- 11.3 (A) A cast should not be performed between a pointer type and an integral type.
- 11.4 (A) A cast should not be performed between a pointer to object type and a different pointer to object type.
- 11.5 (R) A cast shall not be performed that removes any `const` or `volatile` qualification from the type addressed by a pointer.

Expressions

- 12.1 (A) Limited dependence should be placed on C's operator precedence rules in expressions.
- 12.2 (R) The value of an expression shall be the same under any order of evaluation that the standard permits. This rule is checked using worst-case assumptions. This means that a violation will be reported when a possible alias may cause the result of an expression to be evaluation order dependent.
- 12.3 (R) The `sizeof` operator shall not be used on expressions that contain side effects.
- 12.4 (R) The right-hand operand of a logical `&&` or `||` operator shall not contain side effects.
- 12.5 (R) The operands of a logical `&&` or `||` shall be *primary-expressions*.
- 12.6 (A) The operands of logical operators (`&&`, `||` and `!`) should be effectively Boolean. Expressions that are effectively Boolean should not be used as operands to operators other than (`&&`, `||` and `!`).
- 12.7 (R) Bitwise operators shall not be applied to operands whose underlying type is signed.
- 12.8 (R) The right-hand operand of a shift operator shall lie between zero and one less than the width in bits of the underlying type of the left-hand operand. This violation will only be checked when the shift count evaluates to a constant value at compile time.
- 12.9 (R) The unary minus operator shall not be applied to an expression whose underlying type is unsigned.
- 12.10 (R) The comma operator shall not be used.
- 12.11 (A) Evaluation of constant unsigned integer expressions should not lead to wrap-around.
- 12.12 (R) The underlying bit representations of floating-point values shall not be used. A violation is reported when a pointer to a floating-point type is converted to a pointer to an integer type.
- 12.13 (A) The increment (`++`) and decrement (`--`) operators should not be mixed with other operators in an expression.

Control statement expressions

- 13.1 (R) Assignment operators shall not be used in expressions that yield a Boolean value.

TASKING VX-toolset for ARM User Guide

- 13.2 (A) Tests of a value against zero should be made explicit, unless the operand is effectively Boolean.
- 13.3 (R) Floating-point expressions shall not be tested for equality or inequality.
- 13.4 (R) The controlling expression of a `for` statement shall not contain any objects of floating type.
- 13.5 (R) The three expressions of a `for` statement shall be concerned only with loop control. A violation is reported when the loop initialization or loop update expression modifies an object that is not referenced in the loop test.
- 13.6 (R) Numeric variables being used within a `for` loop for iteration counting shall not be modified in the body of the loop.
- 13.7 (R) Boolean operations whose results are invariant shall not be permitted.

Control flow

- 14.1 (R) There shall be no unreachable code.
- 14.2 (R) All non-null statements shall either:
 - a) have at least one side effect however executed, or
 - b) cause control flow to change.
- 14.3 (R) Before preprocessing, a null statement shall only occur on a line by itself; it may be followed by a comment provided that the first character following the null statement is a white-space character.
- 14.4 (R) The `goto` statement shall not be used.
- 14.5 (R) The `continue` statement shall not be used.
- 14.6 (R) For any iteration statement there shall be at most one `break` statement used for loop termination.
- 14.7 (R) A function shall have a single point of exit at the end of the function.
- 14.8 (R) The statement forming the body of a `switch`, `while`, `do ... while` or `for` statement be a compound statement.
- 14.9 (R) An `if (expression)` construct shall be followed by a compound statement. The `else` keyword shall be followed by either a compound statement, or another `if` statement.
- 14.10 (R) All `if ... else if` constructs shall be terminated with an `else` clause.

Switch statements

- 15.1 (R) A switch label shall only be used when the most closely-enclosing compound statement is the body of a `switch` statement.
- 15.2 (R) An unconditional `break` statement shall terminate every non-empty `switch` clause.
- 15.3 (R) The final clause of a `switch` statement shall be the `default` clause.
- 15.4 (R) A `switch` expression shall not represent a value that is effectively Boolean.
- 15.5 (R) Every `switch` statement shall have at least one `case` clause.

Functions

- 16.1 (R) Functions shall not be defined with variable numbers of arguments.
- 16.2 (R) Functions shall not call themselves, either directly or indirectly. A violation will be reported for direct or indirect recursive function calls in the source file being checked. Recursion via functions in other source files, or recursion via function pointers is not detected.
- 16.3 (R) Identifiers shall be given for all of the parameters in a function prototype declaration.
- 16.4 (R) The identifiers used in the declaration and definition of a function shall be identical.
- 16.5 (R) Functions with no parameters shall be declared with parameter type `void`.
- 16.6 (R) The number of arguments passed to a function shall match the number of parameters.
- 16.7 (A) A pointer parameter in a function prototype should be declared as pointer to `const` if the pointer is not used to modify the addressed object.
- 16.8 (R) All exit paths from a function with non-void return type shall have an explicit `return` statement with an expression.
- 16.9 (R) A function identifier shall only be used with either a preceding `&`, or with a parenthesized parameter list, which may be empty.
- 16.10 (R) If a function returns error information, then that error information shall be tested. A violation is reported when the return value of a function is ignored.

Pointers and arrays

- x 17.1 (R) Pointer arithmetic shall only be applied to pointers that address an array or array element.
- x 17.2 (R) Pointer subtraction shall only be applied to pointers that address elements of the same array.
- 17.3 (R) `>`, `>=`, `<`, `<=` shall not be applied to pointer types except where they point to the same array. In general, checking whether two pointers point to the same object is impossible. The compiler will only report a violation for a relational operation with incompatible pointer types.
- 17.4 (R) Array indexing shall be the only allowed form of pointer arithmetic.
- 17.5 (A) The declaration of objects should contain no more than 2 levels of pointer indirection. A violation is reported when a pointer with three or more levels of indirection is declared.
- 17.6 (R) The address of an object with automatic storage shall not be assigned to another object that may persist after the first object has ceased to exist.

Structures and unions

- 18.1 (R) All structure or union types shall be complete at the end of a translation unit.
- 18.2 (R) An object shall not be assigned to an overlapping object.
- x 18.3 (R) An area of memory shall not be reused for unrelated purposes.

- 18.4 (R) Unions shall not be used.

Preprocessing directives

- 19.1 (A) `#include` statements in a file should only be preceded by other preprocessor directives or comments.
- 19.2 (A) Non-standard characters should not occur in header file names in `#include` directives.
- x 19.3 (R) The `#include` directive shall be followed by either a `<filename>` or "filename" sequence.
- 19.4 (R) C macros shall only expand to a braced initializer, a constant, a parenthesized expression, a type qualifier, a storage class specifier, or a do-while-zero construct.
- 19.5 (R) Macros shall not be `#define'd` or `#undef'd` within a block.
- 19.6 (R) `#undef` shall not be used.
- 19.7 (A) A function should be used in preference to a function-like macro.
- 19.8 (R) A function-like macro shall not be invoked without all of its arguments.
- 19.9 (R) Arguments to a function-like macro shall not contain tokens that look like preprocessing directives. A violation is reported when the first token of an actual macro argument is '#'.
- 19.10 (R) In the definition of a function-like macro each instance of a parameter shall be enclosed in parentheses unless it is used as the operand of `#` or `##`.
- 19.11 (R) All macro identifiers in preprocessor directives shall be defined before use, except in `#ifdef` and `#ifndef` preprocessor directives and the `defined()` operator.
- 19.12 (R) There shall be at most one occurrence of the `#` or `##` preprocessor operators in a single macro definition.
- 19.13 (A) The `#` and `##` preprocessor operators should not be used.
- 19.14 (R) The `defined` preprocessor operator shall only be used in one of the two standard forms.
- 19.15 (R) Precautions shall be taken in order to prevent the contents of a header file being included twice.
- 19.16 (R) Preprocessing directives shall be syntactically meaningful even when excluded by the preprocessor.
- 19.17 (R) All `#else`, `#elif` and `#endif` preprocessor directives shall reside in the same file as the `#if` or `#ifdef` directive to which they are related.

Standard libraries

- 20.1 (R) Reserved identifiers, macros and functions in the standard library, shall not be defined, redefined or undefined.
- 20.2 (R) The names of standard library macros, objects and functions shall not be reused.
- x 20.3 (R) The validity of values passed to library functions shall be checked.

- 20.4 (R) Dynamic heap memory allocation shall not be used.
- 20.5 (R) The error indicator `errno` shall not be used.
- 20.6 (R) The macro `offsetof`, in library `<stddef.h>`, shall not be used.
- 20.7 (R) The `setjmp` macro and the `longjmp` function shall not be used.
- 20.8 (R) The signal handling facilities of `<signal.h>` shall not be used.
- 20.9 (R) The input/output library `<stdio.h>` shall not be used in production code.
- 20.10 (R) The library functions `atof`, `atoi` and `atol` from library `<stdlib.h>` shall not be used.
- 20.11 (R) The library functions `abort`, `exit`, `getenv` and `system` from library `<stdlib.h>` shall not be used.
- 20.12 (R) The time handling functions of library `<time.h>` shall not be used.

Run-time failures

- ✘ 21.1 (R) Minimization of run-time failures shall be ensured by the use of at least one of:
 - a) static analysis tools/techniques;
 - b) dynamic analysis tools/techniques;
 - c) explicit coding of checks to handle run-time faults.

21.3. MISRA C:2012

This section lists all supported and unsupported MISRA C:2012 rules.

See also [Section 4.6.2, C Code Checking: MISRA C](#).

A number of MISRA C rules leave room for interpretation. Other rules can only be checked in a limited way. In such cases the implementation decisions and possible restrictions for these rules are listed.

✘ means that the rule is not supported by the TASKING C compiler. (M) is a mandatory rule, (R) is a required rule, (A) is an advisory rule.

A standard C environment

- 1.1 (R) The program shall contain no violations of the standard C syntax and constraints, and shall not exceed the implementation's translation limits.
- 1.2 (A) Language extensions should not be used.
- 1.3 (R) There shall be no occurrence of undefined or critical unspecified behavior.

Unused code

- 2.1 (R) A project shall not contain unreachable code.
- 2.2 (R) There shall be no dead code.
- 2.3 (A) A project should not contain unused type declarations.

TASKING VX-toolset for ARM User Guide

- 2.4 (A) A project should not contain unused tag declarations.
- 2.5 (A) A project should not contain unused macro declarations.
- 2.6 (A) A function should not contain unused label declarations.
- 2.7 (A) There should be no unused parameters in functions.

Comments

- 3.1 (R) The character sequences `/*` and `//` shall not be used within a comment.
- 3.2 (R) Line-splicing shall not be used in `//` comments.

Character sets and lexical conventions

- 4.1 (R) Octal and hexadecimal escape sequences shall be terminated.
- 4.2 (A) Trigraphs should not be used.

Identifiers

- ✘ 5.1 (R) External identifiers shall be distinct.
- ✘ 5.2 (R) Identifiers declared in the same scope and name space shall be distinct.
- ✘ 5.3 (R) An identifier declared in an inner scope shall not hide an identifier declared in an outer scope.
- ✘ 5.4 (R) Macro identifiers shall be distinct.
- ✘ 5.5 (R) Identifiers shall be distinct from macro names.
- ✘ 5.6 (R) A `typedef` name shall be a unique identifier.
- ✘ 5.7 (R) A tag name shall be a unique identifier.
- ✘ 5.8 (R) Identifiers that define objects or functions with external linkage shall be unique.
- ✘ 5.9 (A) Identifiers that define objects or functions with internal linkage should be unique.

Types

- 6.1 (R) Bit-fields shall only be declared with an appropriate type.
- 6.2 (R) Single-bit named bit-fields shall not be of a signed type.

Literals and constants

- 7.1 (R) Octal constants shall not be used.
- 7.2 (R) A `"u"` or `"U"` suffix shall be applied to all integer constants that are represented in an `unsigned` type.
- 7.3 (R) The lowercase character `"l"` shall not be used in a literal suffix trivial.
- 7.4 (R) A string literal shall not be assigned to an object unless the object's type is `"pointer to const-qualified char"`.

Declarations and definitions

- 8.1 (R) Types shall be explicitly specified.
- 8.2 (R) Function types shall be in prototype form with named parameters.
- 8.3 (R) All declarations of an object or function shall use the same names and type qualifiers.
- 8.4 (R) A compatible declaration shall be visible when an object or function with external linkage is defined.
- 8.5 (R) An external object or function shall be declared once in one and only one file.
- 8.6 (R) An identifier with external linkage shall have exactly one external definition.
- 8.7 (A) Functions and objects should not be defined with external linkage if they are referenced in only one translation unit.
- 8.8 (R) The `static` storage class specifier shall be used in all declarations of objects and functions that have internal linkage.
- 8.9 (A) An object should be defined at block scope if its identifier only appears in a single function.
- 8.10 (R) An inline function shall be declared with the `static` storage class.
- 8.11 (A) When an array with external linkage is declared, its size should be explicitly specified.
- 8.12 (R) Within an enumerator list, the value of an implicitly-specified enumeration constant shall be unique.
- 8.13 (A) A pointer should point to a `const`-qualified type whenever possible.
- 8.14 (R) The `restrict` type qualifier shall not be used.

Initialization

- 9.1 (M) The value of an object with automatic storage duration shall not be read before it has been set.
- 9.2 (R) The initializer for an aggregate or union shall be enclosed in braces.
- 9.3 (R) Arrays shall not be partially initialized.
- 9.4 (R) An element of an object shall not be initialized more than once.
- 9.5 (R) Where designated initializers are used to initialize an array object the size of the array shall be specified explicitly.

The essential type model

- 10.1 (R) Operands shall not be of an inappropriate essential type.
- 10.2 (R) Expressions of essentially character type shall not be used inappropriately in addition and subtraction operations.
- 10.3 (R) The value of an expression shall not be assigned to an object with a narrower essential type or of a different essential type category.
- 10.4 (R) Both operands of an operator in which the usual arithmetic conversions are performed shall have the same essential type category.

TASKING VX-toolset for ARM User Guide

- 10.5 (A) The value of an expression should not be cast to an inappropriate essential type.
- 10.6 (R) The value of a composite expression shall not be assigned to an object with wider essential type.
- 10.7 (R) If a composite expression is used as one operand of an operator in which the usual arithmetic conversions are performed then the other operand shall not have wider essential type.
- 10.8 (R) The value of a composite expression shall not be cast to a different essential type category or a wider essential type.

Pointer type conversions

- 11.1 (R) Conversions shall not be performed between a pointer to a function and any other type.
- 11.2 (R) Conversions shall not be performed between a pointer to an incomplete type and any other type.
- 11.3 (R) A cast shall not be performed between a pointer to object type and a pointer to a different object type.
- 11.4 (A) A conversion should not be performed between a pointer to object and an integer type.
- 11.5 (A) A conversion should not be performed from pointer to `void` into pointer to object.
- 11.6 (R) A cast shall not be performed between pointer to `void` and an arithmetic type.
- 11.7 (R) A cast shall not be performed between pointer to object and a non-integer arithmetic type.
- 11.8 (R) A cast shall not remove any `const` or `volatile` qualification from the type pointed to by a pointer.
- 11.9 (R) The macro `NULL` shall be the only permitted form of integer null pointer constant.

Expressions

- 12.1 (A) The precedence of operators within expressions should be made explicit.
- 12.2 (R) The right hand operand of a shift operator shall lie in the range zero to one less than the width in bits of the essential type of the left hand operand.
- 12.3 (A) The comma operator should not be used.
- 12.4 (A) Evaluation of constant expressions should not lead to unsigned integer wrap-around.

Side effects

- 13.1 (R) Initializer lists shall not contain persistent side effects.
- 13.2 (R) The value of an expression and its persistent side effects shall be the same under all permitted evaluation orders.

- 13.3 (A) A full expression containing an increment (++) or decrement (--) operator should have no other potential side effects other than that caused by the increment or decrement operator.
- 13.4 (A) The result of an assignment operator should not be used.
- 13.5 (R) The right hand operand of a logical && or || operator shall not contain persistent side effects.
- 13.6 (M) The operand of the sizeof operator shall not contain any expression which has potential side effects.

Control statement expressions

- 14.1 (R) A loop counter shall not have essentially floating type.
- 14.2 (R) A for loop shall be well-formed.
- 14.3 (R) Controlling expressions shall not be invariant.
- 14.4 (R) The controlling expression of an if statement and the controlling expression of an iteration-statement shall have essentially Boolean type.

Control flow

- 15.1 (A) The goto statement should not be used.
- 15.2 (R) The goto statement shall jump to a label declared later in the same function.
- 15.3 (R) Any label referenced by a goto statement shall be declared in the same block, or in any block enclosing the goto statement.
- 15.4 (A) There should be no more than one break or goto statement used to terminate any iteration statement.
- 15.5 (A) A function should have a single point of exit at the end.
- 15.6 (R) The body of an iteration-statement or a selection-statement shall be a compound-statement.
- 15.7 (R) All if ... else if constructs shall be terminated with an else statement.

Switch statements

- 16.1 (R) All switch statements shall be well-formed.
- 16.2 (R) A switch label shall only be used when the most closely-enclosing compound statement is the body of a switch statement.
- 16.3 (R) An unconditional break statement shall terminate every switch-clause.
- 16.4 (R) Every switch statement shall have a default label.
- 16.5 (R) A default label shall appear as either the first or the last switch label of a switch statement.
- 16.6 (R) Every switch statement shall have at least two switch-clauses.
- 16.7 (R) A switch-expression shall not have essentially Boolean type.

Functions

- 17.1 (R) The features of `<stdarg.h>` shall not be used.
- 17.2 (R) Functions shall not call themselves, either directly or indirectly.
- 17.3 (M) A function shall not be declared implicitly.
- 17.4 (M) All exit paths from a function with non-void return type shall have an explicit `return` statement with an expression.
- 17.5 (A) The function argument corresponding to a parameter declared to have an array type shall have an appropriate number of elements.
- 17.6 (M) The declaration of an array parameter shall not contain the `static` keyword between the `[]`.
- 17.7 (R) The value returned by a function having non-void return type shall be used.
- 17.8 (A) A function parameter should not be modified.

Pointers and arrays

- 18.1 (R) A pointer resulting from arithmetic on a pointer operand shall address an element of the same array as that pointer operand.
- 18.2 (R) Subtraction between pointers shall only be applied to pointers that address elements of the same array.
- 18.3 (R) The relational operators `>`, `>=`, `<` and `<=` shall not be applied to objects of pointer type except where they point into the same object.
- 18.4 (A) The `+`, `-`, `+=` and `-=` operators should not be applied to an expression of pointer type.
- 18.5 (A) Declarations should contain no more than two levels of pointer nesting.
- 18.6 (R) The address of an object with automatic storage shall not be copied to another object that persists after the first object has ceased to exist.
- 18.7 (R) Flexible array members shall not be declared.
- 18.8 (R) Variable-length array types shall not be used.

Overlapping storage

- 19.1 (M) An object shall not be assigned or copied to an overlapping object.
- 19.2 (A) The `union` keyword should not be used.

Preprocessing directives

- 20.1 (A) `#include` directives should only be preceded by preprocessor directives or comments.
- 20.2 (R) The `'`, `"` or `\` characters and the `/*` or `//` character sequences shall not occur in a header file name.
- 20.3 (R) The `#include` directive shall be followed by either a `<filename>` or `"filename"` sequence.

- 20.4 (R) A macro shall not be defined with the same name as a keyword.
- 20.5 (A) `#undef` should not be used.
- 20.6 (R) Tokens that look like a preprocessing directive shall not occur within a macro argument
- 20.7 (R) Expressions resulting from the expansion of macro parameters shall be enclosed in parentheses.
- 20.8 (R) The controlling expression of a `#if` or `#elif` preprocessing directive shall evaluate to 0 or 1.
- 20.9 (R) All identifiers used in the controlling expression of `#if` or `#elif` preprocessing directives shall be `#define`'d before evaluation.
- 20.10 (A) The `#` and `##` preprocessor operators should not be used.
- 20.11 (R) A macro parameter immediately following a `#` operator shall not immediately be followed by a `##` operator.
- 20.12 (R) A macro parameter used as an operand to the `#` or `##` operators, which is itself subject to further macro replacement, shall only be used as an operand to these operators.
- 20.13 (R) A line whose first token is `#` shall be a valid preprocessing directive.
- 20.14 (R) All `#else`, `#elif` and `#endif` preprocessor directives shall reside in the same file as the `#if`, `#ifdef` or `#ifndef` directive to which they are related.

Standard libraries

- 21.1 (R) `#define` and `#undef` shall not be used on a reserved identifier or reserved macro name.
- 21.2 (R) A reserved identifier or macro name shall not be declared.
- 21.3 (R) The memory allocation and deallocation functions of `<stdlib.h>` shall not be used.
- 21.4 (R) The standard header file `<setjmp.h>` shall not be used.
- 21.5 (R) The standard header file `<signal.h>` shall not be used.
- 21.6 (R) The Standard Library input/output functions shall not be used.
- 21.7 (R) The `atoi`, `atol` and `atoll` functions of `<stdlib.h>` shall not be used.
- 21.8 (R) The library functions `abort`, `exit`, `getenv` and `system` of `<stdlib.h>` shall not be used.
- 21.9 (R) The library functions `bsearch` and `qsort` of `<stdlib.h>` shall not be used.
- 21.10 (R) The Standard Library time and date functions shall not be used
- 21.11 (R) The standard header file `<tgmath.h>` shall not be used.
- 21.12 (A) The exception handling features of `<fenv.h>` should not be used.

Resources

- x 22.1 (R) All resources obtained dynamically by means of Standard Library functions shall be explicitly released.

TASKING VX-toolset for ARM User Guide

- x 22.2 (M) A block of memory shall only be freed if it was allocated by means of a Standard Library function.
- x 22.3 (R) The same file shall not be open for read and write access at the same time on different streams.
- x 22.4 (M) There shall be no attempt to write to a stream which has been opened as read-only.
- x 22.5 (M) A pointer to a `FILE` object shall not be dereferenced.
- x 22.6 (M) The value of a pointer to a `FILE` shall not be used after the associated stream has been closed.

X-ON Electronics

Largest Supplier of Electrical and Electronic Components

Click to view similar products for [Altium](#) manufacturer:

Other Similar products are found below :

[07-200-103-804-05-2-1U](#) [11-004-15-1 E](#) [07-200-103-804-05-1](#) [11-100-15-1PE](#)