

Product Data Sheet Type: PR18/35/SE

Group: HEATSINKS Board Level

For single mounting

Width :	18 mm
Height :	20 mm
Length :	35 mm
Minimum thermal resistance :	13 K/W
For device :	TO 220
Device mounted by :	Screw
Heatsink mounted by :	Srew-On
Surface :	Black Anodised
Material :	AlMgSi0,5

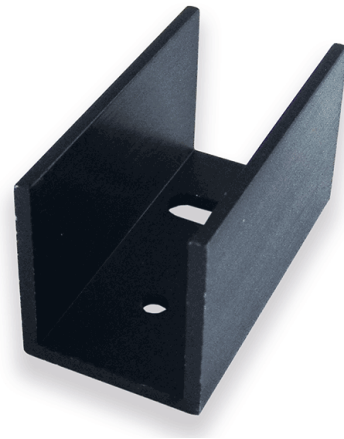

- U-extruded especially for semiconductor case TO220.
- Standard type, ready to be fitted:
 - PR 18/15/SE = with 3 mm hole for standing and lying mounting
 - PR 18/25/SE = with M3-thread for lying mounting
 - PR 18/35/SE = with M3-thread for lying mounting
- Also available in meter lengths.
- Other lengths and machining on request.

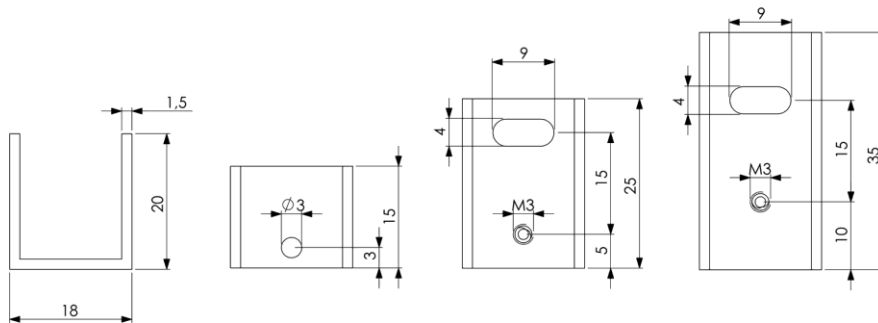

X-ON Electronics

Largest Supplier of Electrical and Electronic Components

Click to view similar products for [Heat Sinks](#) category:

Click to view products by [Alutronic](#) manufacturer:

Other Similar products are found below :

[657-20ABPNE](#) [73452PPBA](#) [A22-4026](#) [120-1873-007](#) [218-40CTE3](#) [253-122ABE-22](#) [PSC22CB](#) [295-2](#) [CLP212SG](#) [D10100-28](#)
[BDN183CBA01](#) [3-21053-4](#) [32438](#) [LAE66A3CB](#) [511-3U](#) [73381PPBA](#) [73403PPBA](#) [7G0047C](#) [8191-E40](#) [510-12M](#) [D10650-40T5](#) [6225B-](#)
[MT6G](#) [ATS-54310K-C2-R0](#) [648-51AB](#) [657-20ABPESC](#) [679-25AG](#) [FK 212 CB SA](#) [FK225 SA L1](#) [6801G](#) [680-5K](#) [SK145 37 5STSTO220](#)
[TS-11042-CY](#) [S14K35G3S5](#) [8924G](#) [7717-133DAP](#) [7717-26DAP](#) [4509](#) [SW25-4G](#) [CLP-215](#) [CLP-207](#) [SK409 25 4STS](#) [SK104 50 8STS](#)
[SK129 25 4STS](#) [SK129 50 8STS](#) [D20850-40-T2](#) [APF30-30-10CB/A01](#) [V8508E](#) [268-85CTE](#) [43808-04](#) [BDN123CBA01](#)