

客户 (Customer) : _____

承认书

Approval Sheet

谨致执事者：兹提供敝公司之有关详细规格及图面数据,敬请给予办理试认定手续.

同时敬请送返一份附有贵公司签认之测试认定后之样品承认书.

We are pleased in sending you herewith on specification and drawings for your approval.

Please return to us one copy "Approval sheet" with your approved signature.

型号 (Model No.) : _____ A-IA3R326CIR1C-D _____

发文日期 (Issue Date) : 2020/12/04 承认日期 (Approved Date) : _____

Checking signature of Amicc

Designer	Checker	Approver
Darren		

Approval signature of customer

Designer	Checker	Approver

江苏欧密格光电科技股份有限公司

Jiangsu Amicc Opto-Electronics Technology Co.,Ltd

地址:江苏省常州市湖塘鸣凰沟南工业区武南中路 98 号

Add: 98.Wu Nan middle road.Gounan Industrial Park Changzhou

TEL:0086-519-89806966

FAX:0086-519-86523668

Lamp IRED Type ■ 3.0mm Dia

A-IA3R326CIR1C-D

Features

- 3.0 mm Dia LED LAMP
- Wide viewing angle
- Pb-free
- RoHS compliant

Description

The Amicc LAMP package has high efficacy, high power consumption, wide viewing angle and a compact form factor. These features make this package an ideal LED for all lighting applications.

Applications

- Emitters of remote control
- Smoke sensors

Device Selection Guide

Chip Materials	Emitted Color	Resin Color
GaAIAs	IR	Water Clear

Absolute Maximum Ratings (T_a=25°C)

Parameter	Symbol	Rating	Unit
Forward Current	I _F	100	mA
Peak Forward Current (Duty 1/10 @1ms)	I _{FP}	1000	mA
Power Dissipation	P _d	150	mW
Derating Linear From 25°C Per Chip		0.4	mA/°C
Reverse Voltage per chip	V _r	5	V
Operating Temperature	T _{opr}	-40 ~ +85	°C
Storage Temperature	T _{stg}	-40 ~ +85	°C

Note:

The products are sensitive to static electricity and must be carefully taken when handling products.

Electro-Optical Characteristics (T_a=25°C)

Parameter	Symbol	Min.	Typ.	Max.	Unit	Condition
Radiant Intensity	I _E	13	20	30	mw/sr	I _F =20mA
		60	80	145		I _F =100mA
Peak Emission Wavelength	λ _p	-----	940	-----	nm	I _F =20mA
Forward Voltage	V _F	-----	1.2	-----	V	I _F =20mA
		-----	1.4	-----		I _F =100mA
Viewing Angle	2θ _{1/2}	-----	30	-----	deg	I _F =20mA
Reverse Current	I _R	-----	-----	10	μA	V _R =5V

Notes:

1. Tolerance of Radiant Intensity ±10%.
2. Tolerance of Forward Voltage : ±0.1V.

Typical Electro-Optical Characteristics Curves

Fig.1-Forward Voltage Shift vs. Junction Temperature

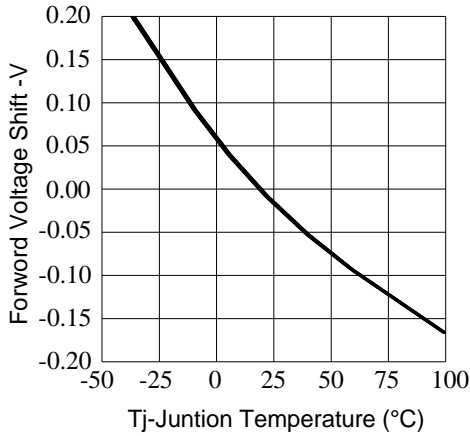

Fig.2-Relative Luminous Intensity vs. Forward Current

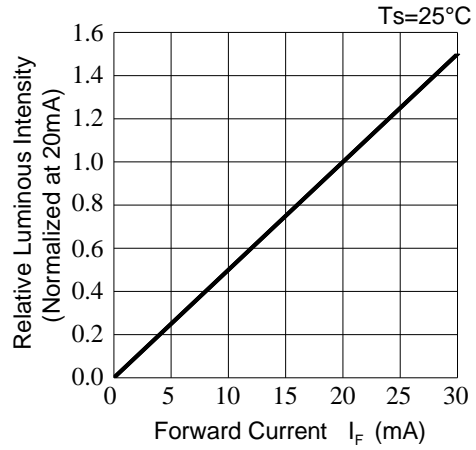

Fig.3-Relative Luminous Intensity vs. Junction Temperature

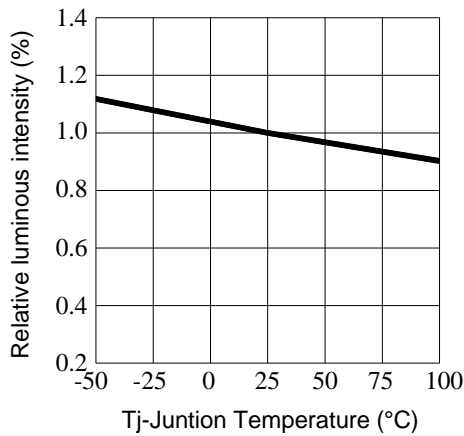

Fig.4-Forward Current vs. Forward Voltage

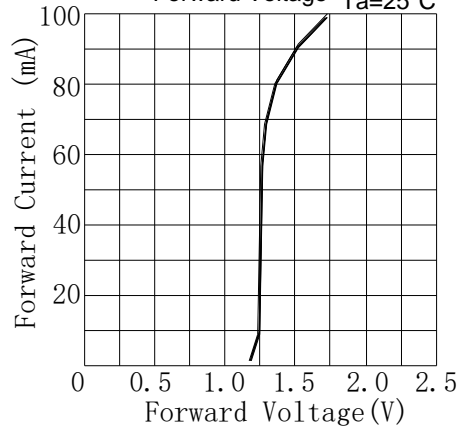

Fig.5-Max. Driving Forward Current vs. Soldering Temperature

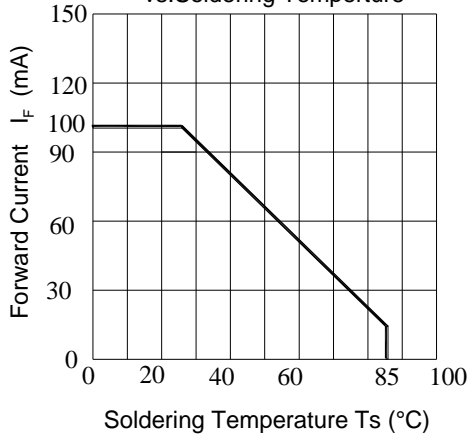
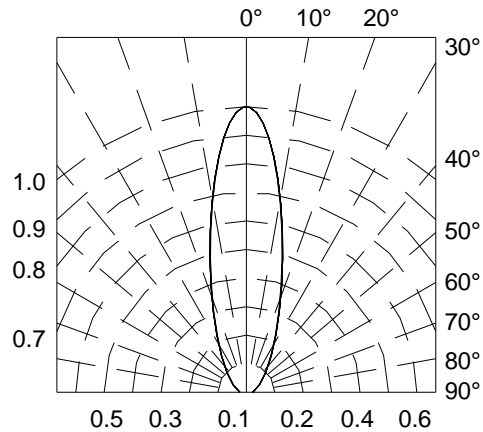
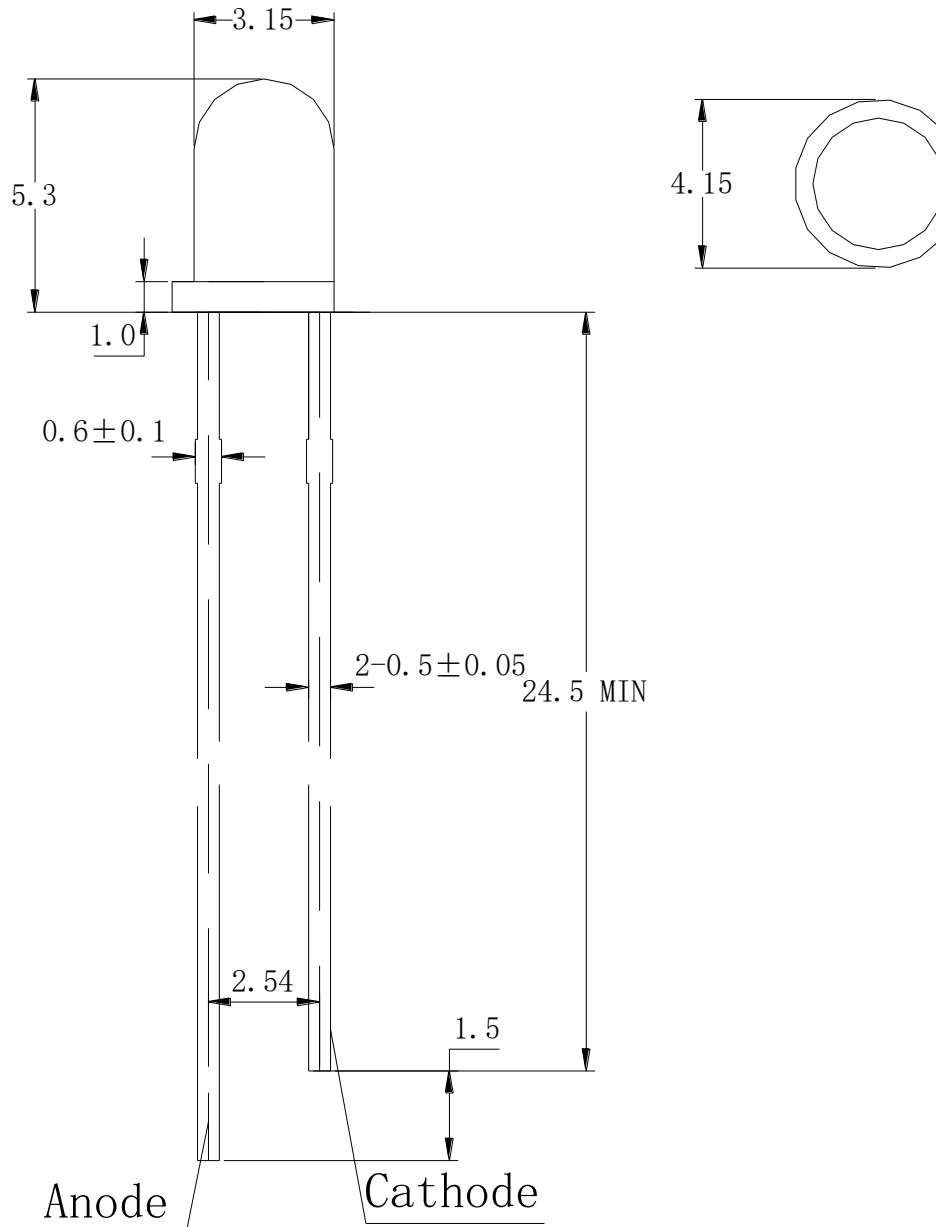

Fig.6-Radiation Diagram



Package Dimension



Note:

- 1.All Dimensions are in millimeters.
- 2.Tolerance is $\pm 0.25\text{mm}$ (0.010 ")Unless otherwise specified.

Moisture Resistant Packing Materials

Label Explanation

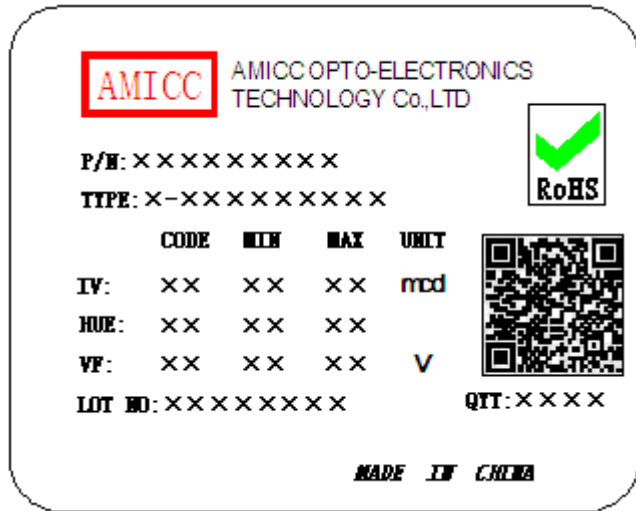

- CPN: Customer's Product Number
- P/N: Product Number
- TYPE :Part NO.
- IV: Luminous Intensity Rank
- HUE: Chromaticity Coordinates Rank
- VF: Forward Voltage Rank
- LOT NO.: Lot Number
- QTY: Packing Quantity

Moisture Resistant Packing Process : 1000 PCS/Bag

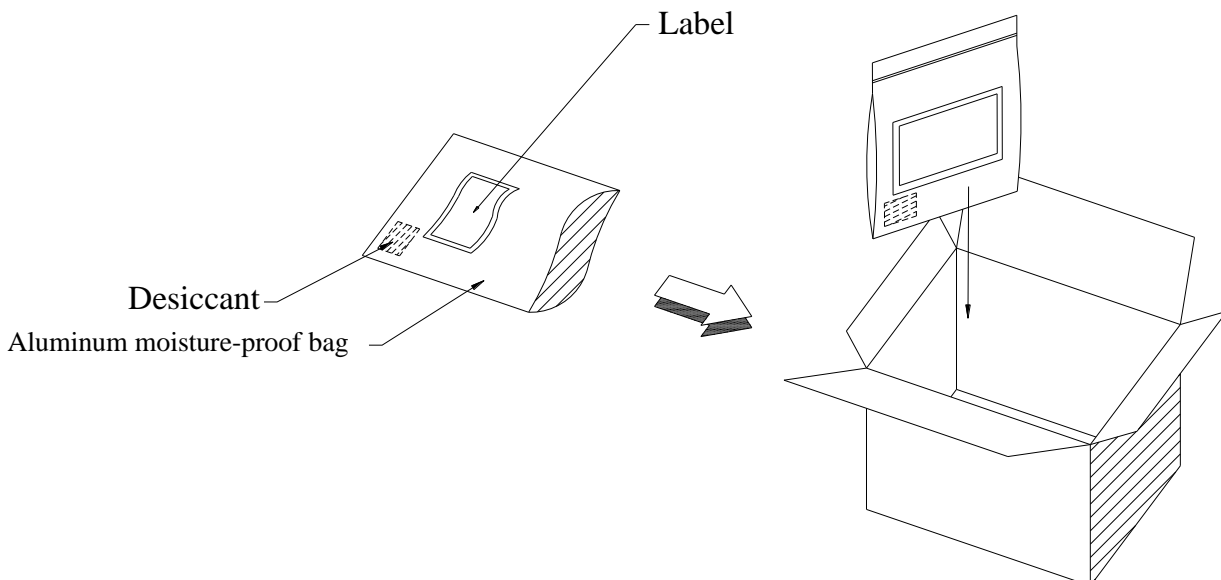

Reliability Test Items and Conditions

The reliability of products shall be satisfied with items listed below.

Confidence level : 90%

LTPD : 10%

No.	Items	Test Condition	Test Hours/Cycles	Sample Size	Ac/Re
1	Wave Soldering	T, sol:260°C/5sec	3 Cycles	22PCS	0/1
2	Solderability	T, sol:230°C/5sec	60 sec. Max.	22PCS	0/1
3	Thermal Shock	H : +105°C 10min ↓ L : -55°C 10min	10 Cycles	22 PCS.	0/1
4	Temperature Cycle	H : +105°C 30min ↓ 25°C 5min ↓ L : -55°C 30min ↓ 25°C 5min	10 Cycles	22 PCS.	0/1
5	High Temperature/Humidity Reverse Bias	Ta=65°C,90%RH	240 Hrs.	22 PCS.	0/1
6	DC Operation Life	Ta=25°C, I _F = 20 mA	1000 Hrs.	22 PCS.	0/1

Precautions for Use

1. Over-current-proof

Customer must apply resistors for protection; otherwise slight voltage shift will cause big current change (Burn out will happen).

2. Storage

2.1 Do not open moisture proof bag before the products are ready to use.

2.2 Before opening the package: The LEDs should be kept at 30°C or less and 90%RH or less.

2.3 After opening the package: The LED's floor life is 1 year under 30°C or less and 60% RH or less. If unused LEDs remain, it should be stored in moisture proof packages.

2.4 If the moisture absorbent material (silica gel) has faded away or the LEDs have exceeded the storage time, baking treatment should be performed using the following conditions.

Baking treatment: 60±5°C for 24 hours.

3. Soldering

Method	Remark
Hand Soldering	1. Soldering time : 350°C , 3 sec MAX. 2. Distance : 3 mm MIN (from solder joint to case)
DIP Soldering	1. Preheat temp : 100 °C MAX , 60 sec MAX. 2. Bath temp : 260 °C MAX. 3. Bath time : 5 sec MAX. 4. Distance : 3 mm MIN (From solder joint to case.)

Lamp wave soldering profile :

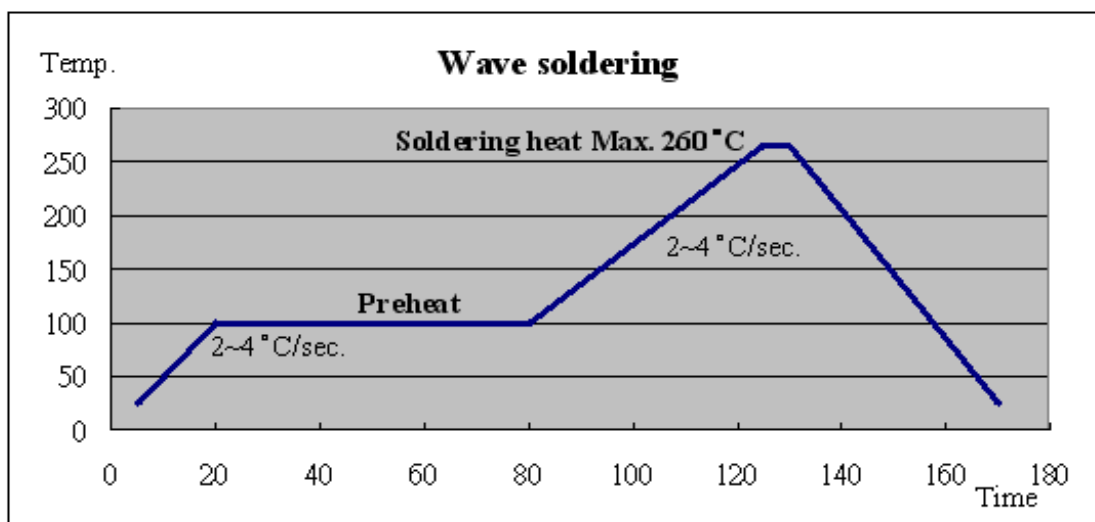

4. Cleaning

Do not use unspecified chemical liquid to clean LED. They could harm it IF cleaning is necessary, wipe the pin out with alcohol、Freon TE or Chlorosen at normal temperature for less than 1 minute or wipe the surface with alcohol.

5. Methods Antistatic Static Electricity

Static electricity is the enemy of lamps emitting blue and green. Workers must put on working rings, gloves, clothes that protect static electricity while working. Wires of the rings keep well together with the floor and there must be wires to connect the irons and the floor.

6. Over-current-proof

6-1. Be not over-current.

6-2. In order to cooperate LEDs under stable conditions, put protective resistor in series. Resistor values can be determined by supplying voltage or current for the LEDs. Recommended current is in the range of forward current 5mA-20mA.

6-3. Circuit must be designed so that overvoltage is not applied to the LED during on/off switching. Transient or pulse current will damage junction of LED die.

7. Soldering Iron

Each terminal is to go to the tip of soldering iron temperature less than 300°C for 3 seconds within once in less than the soldering iron capacity 30W. Leave two seconds and more intervals, and do soldering of each terminal. Be careful because the damage of the product is often started at the time of the hand solder.

8. Repairing

Repair should not be done after the LEDs have been soldered. When repairing is unavoidable, a double-head soldering iron should be used (as below figure). It should be confirmed beforehand whether the characteristics of the LEDs will or will not be damaged by repairing.

X-ON Electronics

Largest Supplier of Electrical and Electronic Components

Click to view similar products for [Amicc manufacturer](#):

Other Similar products are found below :

[A-SP192GB1D-B01-4T\(HW\)](#) [A-SP1512R6GHC-A01-2A](#) [A-SA3HR334GYRD019](#) [A-SA3HR314GGGGW033-H440](#) [A-SA6S6091RPGCE070-CA](#) [A-SA3HR314GGW026-H22](#) [A-SA3HR324GW014](#) [AM817S\(B\)\(T1\)-FG](#) [A-IRM38G17SC9](#) [A-SA3HR314GD007-H11](#) [A-IA3R326CIR1C-D](#) [A-SA5HR503RG022-H6101](#) [A-SA3R3140RBWE073-CA](#) [A-SP110B1C-C01-2C](#) [A-SA3HR3040SRDN122-H11](#) [A-SA3HR314RGW029-H22](#) [A-SP153IR1C-A02-2D](#) [A-SP192YW1D-D04-4T](#) [A-SI2020R6AGHB1C-C01-2T](#) [AM816S\(B\)\(T1\)-CG](#) [A-SP192CW1D-C06-4T](#) [A-SC6303AR6AGHY3AC-A01-2T](#) [A-SP194R6C-C01-3T](#) [A-SP1103R6AGHB1W-C01-2C](#) [A-SC880IR3C-P03-1T](#) [A-SC667R6AGHB1W-A01-1T](#) [A-SP110W1D-C03-2C](#) [A-SP1502R6W1D-A01-2T](#) [A-SP110R6C-C01-2C](#) [A-SC6302B1R6C-A02-2T](#) [A-SP150B1C-A01-3T](#) [A-SP153IR1C-A02-2T](#) [A-SP1103R6GHB1W-C01-2C](#) [A-SA3R302BWCE062-30](#) [A-SA3R3040BWCE061](#) [A-SL660B1C-C01-4T](#) [A-SP170B1C-C02-3T](#) [A-SP150Y3AC-A01-3T](#) [A-SP192GS1D-C01-4T](#) [A-SP1102DR6W1D-C01-2C](#) [A-SP1923XR6GHB1C-A01-3T](#) [A-SP110GHC-C01-2C](#) [A-SP110W1D-C01-2C](#) [A-SC6303R6AGHB1C-A01-2T](#) [A-SP1942R5G2C-C01-2T](#) [A-SP158IR1C-A02-2D](#) [A-SP192YR6C-A01-4T](#) [A-SC6302R6AGHC-A03-2T](#) [A-SP150R6AC-A01-3T](#) [A-SP194ZW1D-C07-4T](#)