

客户 (Customer) : _____

承认书
Approval Sheet

谨致执事者：兹提供敝公司之有关详细规格及图面数据，敬请给予办理试认定手续。
同时敬请送返一份附有贵公司签认之测试认定后之样品承认书。

We are pleased in sending you herewith on specification and drawings for your approval.
Please return to us one copy "Approval sheet" with your approved signature.

型号 (Model No.) : AM817 Series

发文日期 (Issue Date) : 2022/09/14 承认日期 (Approved Date) : _____

Checking signature of Amicc

Designer	Checker	Approver
Money		

Approval signature of customer

Designer	Checker	Approver

江苏欧密格光电科技股份有限公司
Jiangsu Amicc Opto-Electronics Technology Co.,Ltd
地址: 江苏省常州市湖塘鸣凰沟南工业区武南中路 98 号
Add: 98.Wu Nan middle road.Gounan Industrial Park Changzhou
TEL:0086-519-89806966
FAX:0086-519-86523668

4 PIN DIP PHOTOTRANSISTOR PHOTOCOUPLER AM817 Series

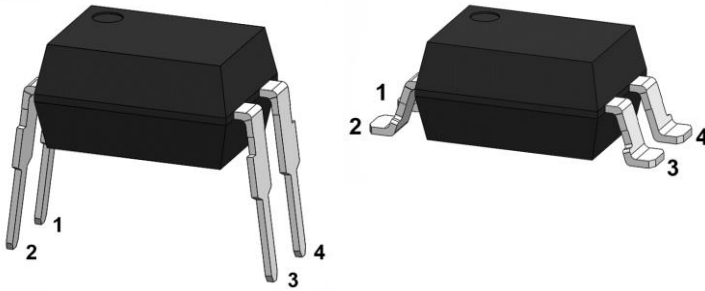

Pin and Internal Connection Diagram

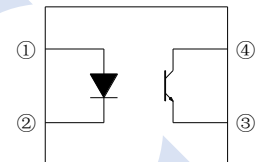

1. Anode
2. Cathode
3. Emitter
4. Collector

Features

- Current transfer ratio (CTR: 50~600% at $I_F = 5\text{mA}$, $V_{CE} = 5\text{V}$)
- High input-output isolation voltage ($V_{iso} = 5,000\text{Vrms}$)
- Creepage distance $> 7.62\text{mm}$
- Operating temperature up to $+110^\circ\text{C}$

Description

The AM817 series of devices each consist of an infrared emitting diodes, optically coupled to a phototransistor detector.

They are packaged in a 4-pin DIP package and two forms (DIP, SMD).

Applications

- Programmable controllers
- Home appliances, such as air conditioners, fans, water heaters, etc.
- Industrial control, measuring instruments
- Switching power supply, smart meter

Absolute Maximum Ratings (Ta=25°C)

	Parameter	Symbol	Rating	Unit
Input	Forward Current	I _F	50	mA
	Reverse Voltage	V _R	6	V
	Power Dissipation	P _D	70	mW
	Thermal Resistance Junction-Ambient	R _{thJ-A}	325	°C/W
	Thermal Resistance Junction-Case	R _{thJ-C}	200	°C/W
Output	Power Dissipation	P _C	150	mW
	Collector Current	I _C	50	mA
	Collector-Emitter Voltage	V _{CEO}	80	V
	Emitter-Collector Voltage	V _{ECO}	7	V
Total Power Dissipation		P _{TOT}	200	mW
Isolation Voltage* ¹		V _{ISO}	5000	V _{rms}
Operating Temperature		T _{OPR}	-55 to 110	°C
Storage Temperature		T _{STG}	-55 to 125	°C
Soldering Temperature* ²		T _{SOL}	260	°C

Notes:

*1. AC For 1 Minute, R.H. = 40 ~ 60%

Isolation voltage shall be measured using the following method.

- (1) Short between anode and cathode on the primary side and between collector and emitter on the secondary side.
- (2) The isolation voltage tester with zero-cross circuit shall be used.
- (3) The waveform of applied voltage shall be a sine wave.

*2. For 10 Seconds

Electro-Optical Characteristics (Ta=25°C)

Parameter		Symbol	Min.	Typ.	Max.	Unit	Test Condition
Input	Forward Voltage	V_F	-	1.2	1.4	V	$I_F = 20\text{mA}$
	Reverse Current	I_R	-	-	10	μA	$V_R = 4\text{V}$
	Terminal Capacitance	C_t	-	30	250	pF	$V = 0, f = 1\text{KHz}$
Output	Collector Dark Current	I_{CEO}	-	-	100	nA	$V_{CE} = 20\text{V}, I_F = 0$
	Collector-Emitter Breakdown Voltage	BV_{CEO}	80	-	-	V	$I_C = 0.1\text{mA}$
	Emitter-Collector Breakdown Voltage	BV_{ECO}	7	-	-	V	$I_E = 0.1\text{mA}$
Transfer Characteristics	AM817		50	-	600		
	AM817A		80	-	160		
	AM817B		130	-	260		
	AM817C	CTR*	200	-	400	%	$I_F = 5\text{mA}, V_{CE} = 5\text{V}$
	AM817D		300	-	600		
	AM817X		100	-	200		
	AM817Y		150	-	300		
	Collector-Emitter Saturation Voltage		$V_{CE(sat)}$	-	0.1	0.2	
Isolation Resistance	R_{IO}	5×10^{10}	-	-	Ω	DC 500V, 40~60% R.H.	
Floating Capacitance	C_{IO}	-	0.6	1.0	pF	$V_{IO} = 0, f = 1\text{MHz}$	
Cut-off Frequency	f_c	-	80	-	kHz	$V_{CE} = 5\text{V}, I_C = 2\text{mA}$ $R_L = 100\Omega, -3\text{dB}$	
Rise time	t_r	-	6	18	μs	$V_{CE} = 2\text{V}, I_C = 2\text{mA},$ $R_L = 100\Omega$	
Fall time	t_f	-	8	18	μs		

* $CTR = I_C / I_F * 100\%$

Typical Electro-Optical Characteristics Curves

Fig.1 - Forward Current vs Forward Voltage

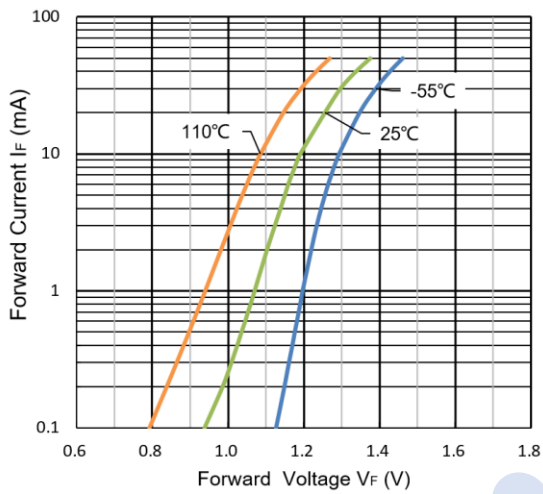

Fig.2 - Relative Current Transfer Ratio vs Forward Current

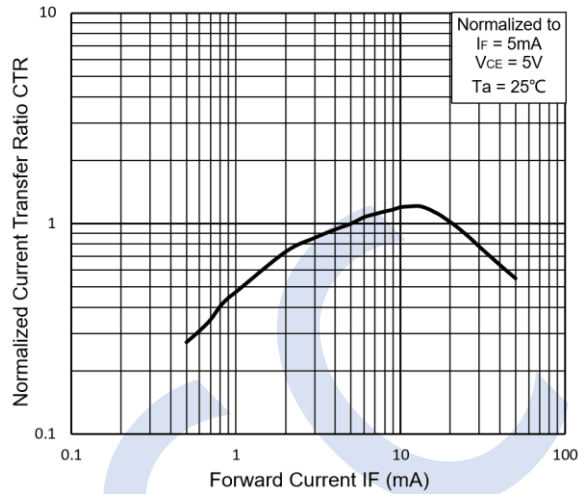

Fig.3 - Relative Current Transfer Ratio vs Ambient Temperature

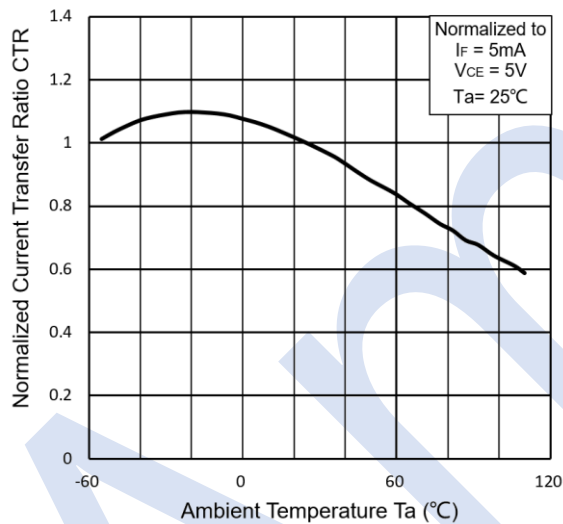

Fig.4 - Collector Dark Current vs Ambient Temperature

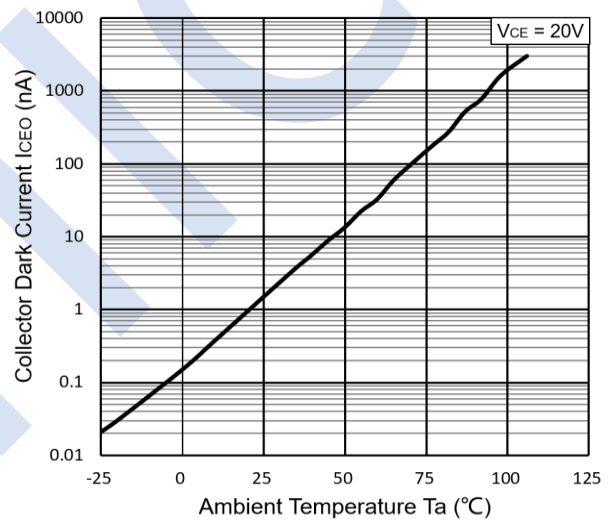

Fig.5 - Collector-Emitter Voltage vs Collector Current

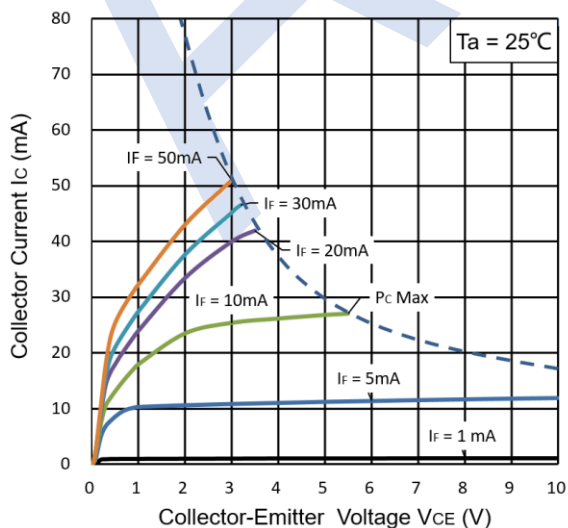

Fig.6 - Switching Time vs Load Resistance

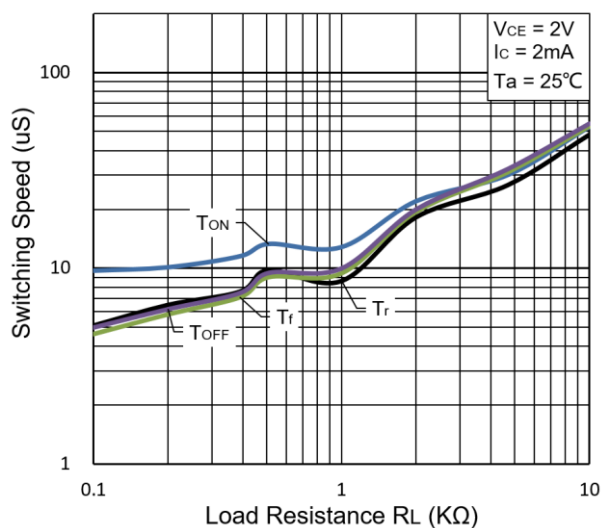
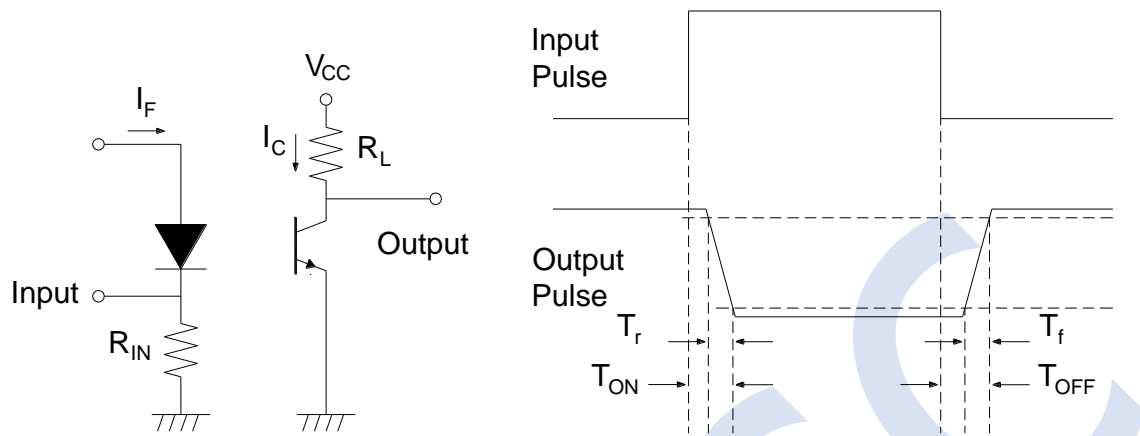

Fig.7 - Switching Time Test Circuit & Waveforms



Order Information

Part Number

AM817X(Y)(Z)-FVG

Note

- X = Lead form option
No suffix = Dual-in-Line package
S = Surface mounting package
M = Wide lead spacing package
- Y = CTR Rank
Please refer to the CTR table on Page P4
- Z = TAPING TYPE
T1, T2, or none)
- F = Lead frame option
F = Iron, C = copper)
- V = VDE order option
- G = Halogen free option

Option	Description	Packing quantity		
None	Dual-in-Line package	100 units per tube	50 tubes/inner box	10 inner boxes/outer box
S	Surface mounting package	2000 units per reel	4 reels/inner box	5 inner boxes/outer box

Device Marking

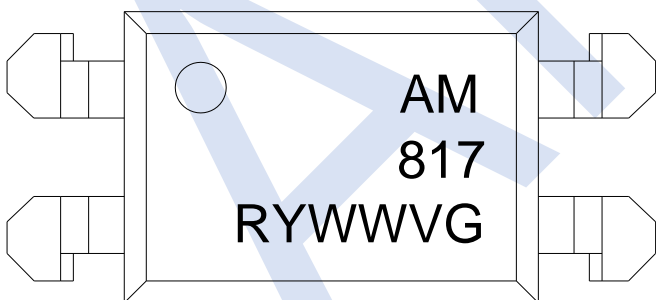

Notes

- AM denotes Amicc
- 817 denotes Device Number
- R denotes CTR Rank
- Y denotes 1 digit Year code
- WW denotes 2 digit Week code
- V denotes VDE (optional)
- G denotes Halogen free

Package Dimension (Dimensions in mm)

Dual-in-Line package

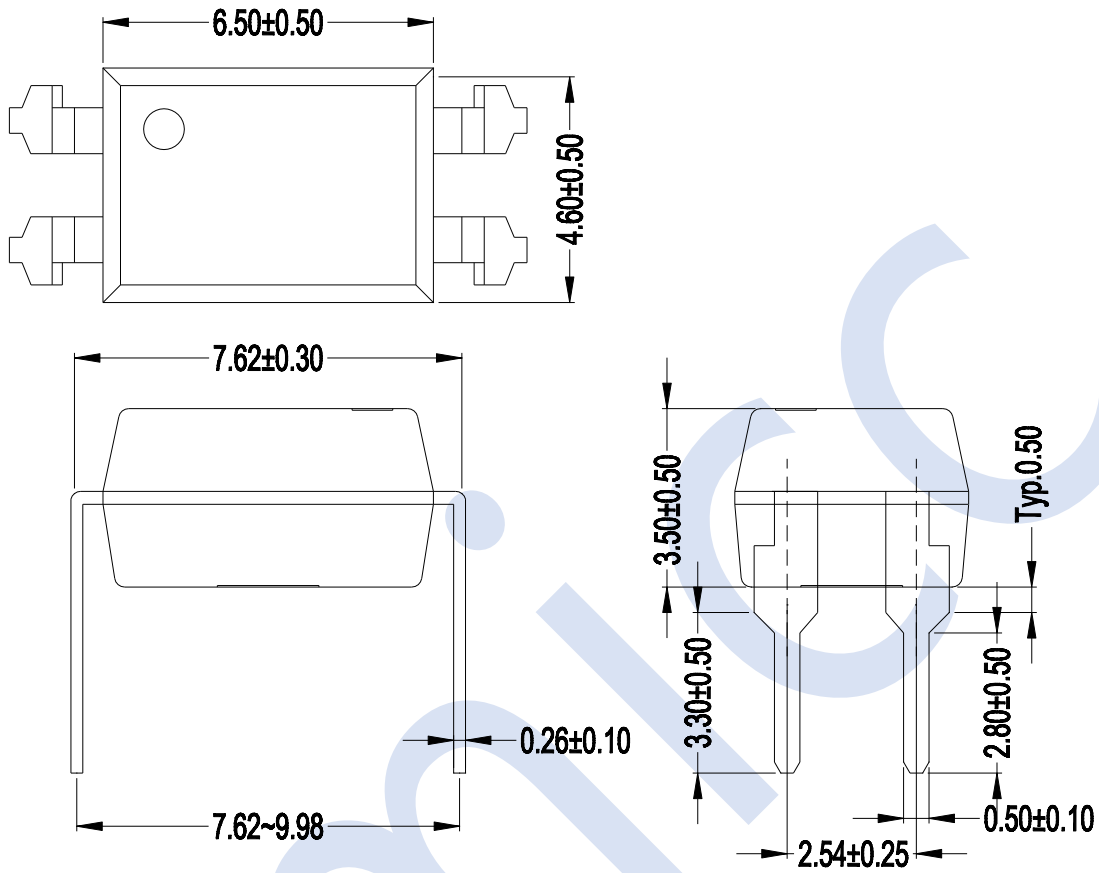

Surface mounting package

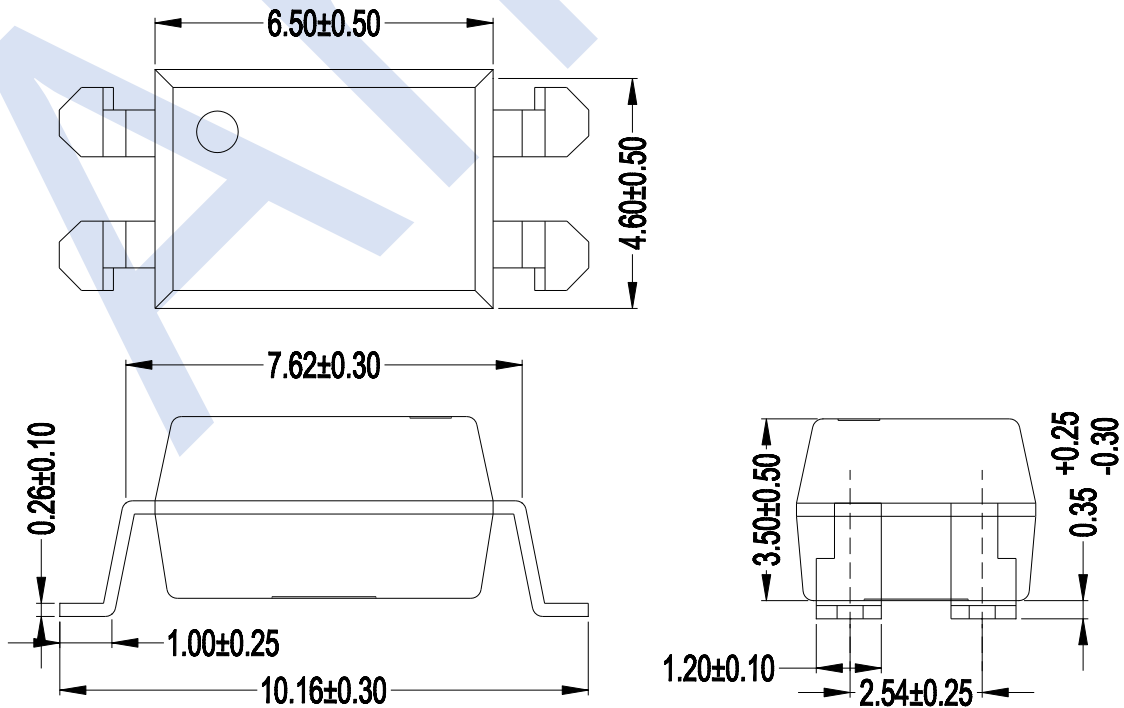

Tape & Reel Packing Specifications

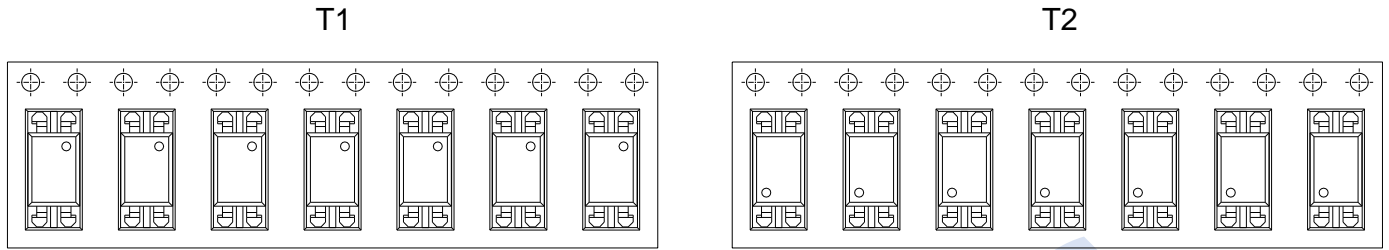

Tape dimensions

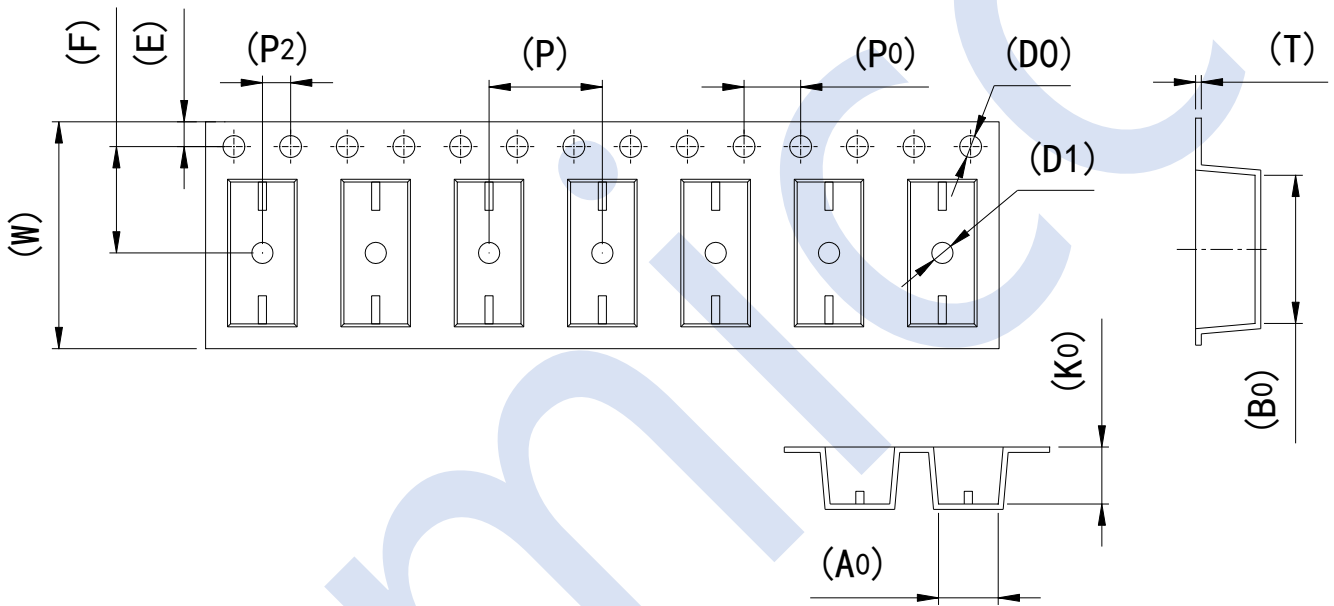

Dimension No.	A0	B0	D0	D1	E	F
mm	4.70±0.10	10.45±0.10	1.55±0.10	1.50±0.10	1.75±0.10	7.50±0.10
Dimension No.	P0	P1	P2	T	W	K0
mm	4.00±0.10	8.00±0.10	2.00±0.10	0.35±0.10	16.00±0.30	4.10±0.10

Label Explanation

Amicc AMICC OPTO-ELECTRONICS
TECHNOLOGY CO.,LTD

P/N: AR0C000001



TYPE: AM817S(C)(T1)-FG

CAT: C

REF: T1

QTY: 2000 PCS

LOT: G2082401D207C209



- ◆P/N: Product Number
- ◆TYPE: Part No.
- ◆CAT: BIN Number
- ◆REF: Packaging Number
- ◆QTY: Packing Quantity
- ◆LOT: Lot Number

Amicc

Recommended soldering conditions of reflow

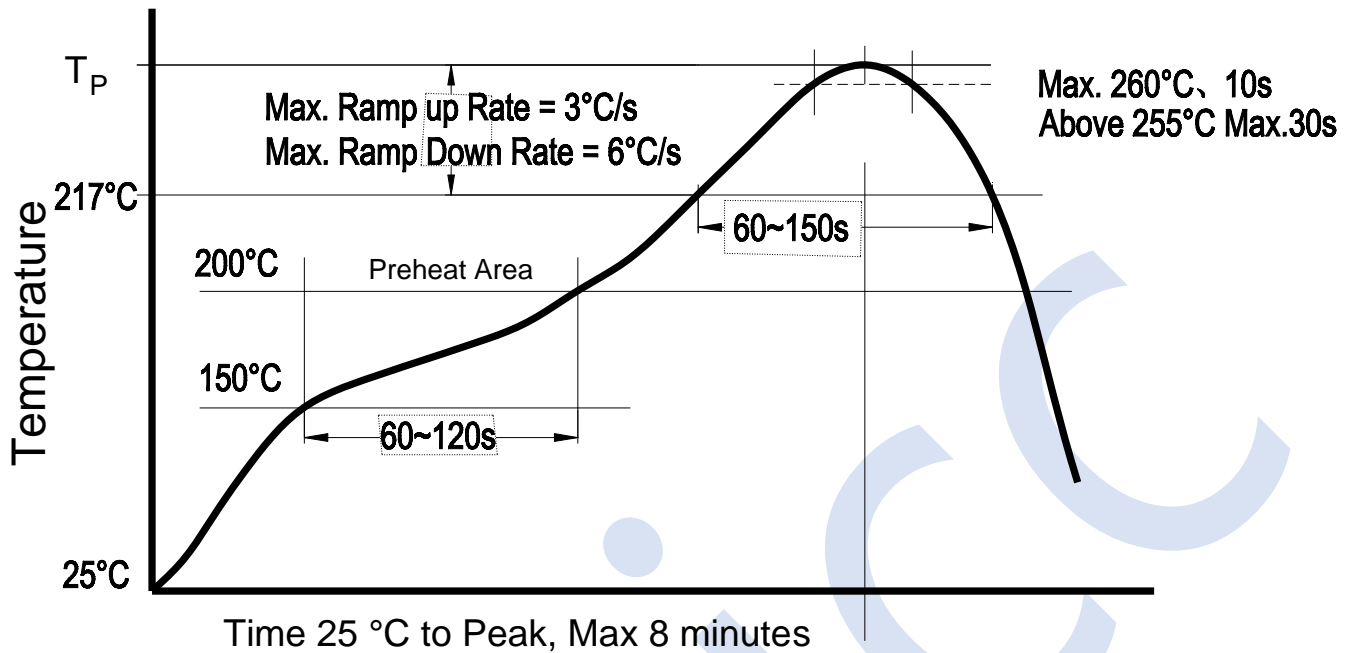

Soldering times: 3 times

DISCLAIMER

1. Above specification may be changed without notice. Amicc will reserve authority on material change for above specification.
2. The graphs shown in this datasheet are representing typical data only and do not show guaranteed values.
3. When using this product, please observe the absolute maximum ratings and the instructions for use outlined in these specification sheets. Amicc assumes no responsibility for any damage resulting from use of the product which does not comply with the absolute maximum ratings and the instructions included in these specification sheets.
4. These specification sheets include materials protected under copyright of Amicc. Reproduction in any form is prohibited without the specific consent of Amicc.
5. This product is not intended to be used for military, aircraft, automotive, medical, life sustaining or life saving applications or any other application which can result in human injury or death. Please contact authorized Amicc sales agent for special application request.

X-ON Electronics

Largest Supplier of Electrical and Electronic Components

Click to view similar products for [Transistor Output Optocouplers](#) category:

Click to view products by [Amicc](#) manufacturer:

Other Similar products are found below :

[LTV-814S-TA](#) [LTV-852S](#) [66095-001](#) [PS2561-1-A](#) [PS2561A-1-W-A](#) [PS2561L1-1-A](#) [PS2561L-1-V-A](#) [PS2706-1-A](#) [PS2815-1-A](#) [MRF658](#)
[ELD207\(TA\)](#) [ILD2-X006](#) [ILQ615-3X016](#) [LDA102S](#) [SFH615A-4XSM TR](#) [PS2561DL-1Y-F3-A](#) [PS2561L1-1-L-A](#) [PS2562-1-V-A](#) [PS2565L-](#)
[1-A](#) [PS2581L2-A](#) [PS2701A-1-F3-P-A](#) [PS2711-1-A](#) [PS2801-1-F3-P-A](#) [PS2833-4-A](#) [PS2841-4A-AX](#) [LTV-702FS](#) [LTV-702V](#) [LTV-702VB](#)
[LTV-816S-TA](#) [TCET2100](#) [TLP290-4\(E\(T](#) [IL215AT](#) [WPPC-A11066AA](#) [WPPC-A11066AD](#) [WPPC-A11084ASS](#) [WPPC-A21068AA](#) [WPPC-](#)
[D11066AA](#) [WPPC-D21068ED](#) [WPPC-D410616EA](#) [WPPC-D410616ED](#) [X4IAC24A](#) [4N26-X001](#) [EL1010\(TA\)-VG](#) [SFH600-2X007](#)
[TCMT1118](#) [VO206AT](#) [WPPC-D21068EA](#) [WPPC-D11064AD](#) [WPPC-A410616AD](#) [WPPC-A21068AD](#)