

客户 (Customer) : _____

承认书

Approval Sheet

谨致执事者：兹提供敝公司之有关详细规格及图面数据，敬请给予办理试认定手续。
同时敬请送返一份附有贵公司签认之测试认定后之样品承认书。

We are pleased in sending you herewith on specification and drawings for your approval.
Please return to us one copy "Approval sheet" with your approved signature.

型号 (Model No.) : A-SC6303AR6AGHY3AC-A01-2T(Premilinary)

发文日期 (Issue Date) : 2022/05/30 承认日期 (Approved Date) : _____

Checking signature of Amicc

Designer	Checker	Approver
Zora	Tommy	Solarliu

Approval signature of customer

Designer	Checker	Approver

江苏欧密格光电科技股份有限公司

Jiangsu Amicc Opto-Electronics Technology Co.,Ltd.

地址：江苏省常州市武进区武南中路 98 号

Add: 98.Wu Nan Road, Wujin, Changzhou city, Jiangsu Province

TEL:0086-519-89806999

FAX:0086-519-86523668

Top view LED Type ■ PLCC Package

A-SC6303AR6AGHY3AC-A01-2T(Premilinary)



■ Features

- PLCC package
- Top view RGY LED
- High luminous Intensity output
- Wide viewing angle
- Pb-free
- RoHS compliant
- JEDEC-MSL 3

■ Description

The Amicc 6303A package has high efficacy, low power consumption, wide viewing angle and a compact form factor. These features make this package to be an ideal LED for all lighting applications.

■ Applications

- General lighting
- Decorative and Entertainment Lighting
- Indicators
- Illumination
- Switch light

■ Device Selection Guide

Type	Chip Materials	Emitted Color	Resin Color
R6A	AlGaInP	Brilliant Red	Water Clear
GH	InGaN	Green	
Y3A	AlGaInP	Brilliant Yellow	

■ Package Dimensions

Top View

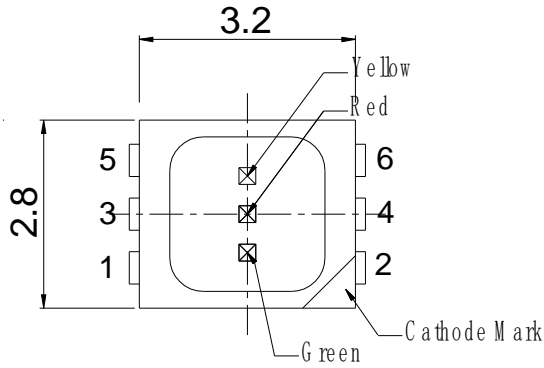

Side View

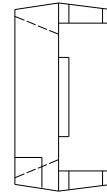

Side View

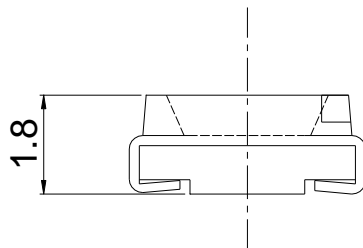

Polarity

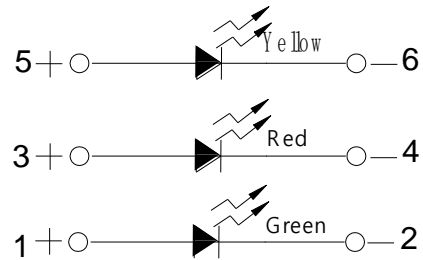

Bottom View

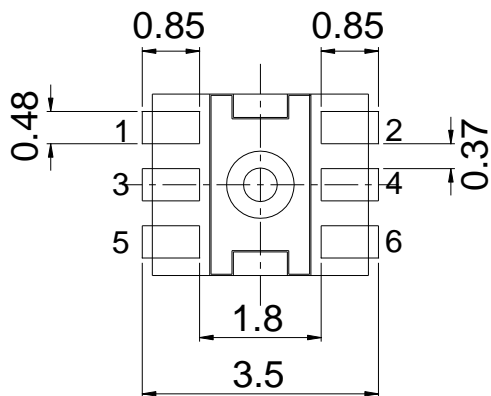

Recommended solder pad

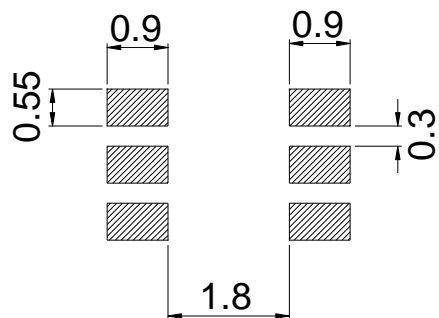

Note:
 Tolerance without mention is ± 0.1 mm.

■ **Absolute Maximum Ratings (T_{Soldering}=25°C)**

Parameter	Symbol	Color	Rating	Unit
Forward Current	I _F	R6A	30	mA
		GH	30	
		Y3A	30	
Peak Forward Current (Duty 1/10 @1ms)	I _{FP}	R6A	90	mA
		GH	90	
		Y3A	90	
Power Dissipation	P _d	R6A	72	mW
		GH	102	
		Y3A	72	
Electrostatic Discharge(HBM)	ESD	R6A	2000	V
		GH	2000	
		Y3A	2000	
Operating Temperature	T _{opr}		-40 ~ +85	°C
Storage Temperature	T _{stg}		-40 ~ +100	°C
Soldering Temperature	T _{sol}		Reflow Soldering : 260 °C for 10 sec. Hand Soldering : 350 °C for 3 sec.	

Note:

The products are sensitive to static electricity and must be carefully taken when handling products.

■ **Electro-Optical Characteristics (T_{Soldering}=25°C)**

Parameter	Symbol	Color	Min.	Typ.	Max.	Unit	Condition
Luminous Intensity	I _v	R6A	715	-----	1800	mcd	I _F =20mA
		GH	1120	-----	2850		
		Y3A	360	-----	900		
Peak Wavelength	λ _p	R6A	-----	630	-----	nm	I _F =20mA
		GH	-----	515	-----		
		Y3A	-----	590	-----		
Dominant Wavelength	λ _d	R6A	615	-----	630	nm	I _F =20mA
		GH	515	-----	530		
		Y3A	586	-----	594		
Forward Voltage	V _F	R6A	1.9	-----	2.3	V	I _F =20mA
		GH	2.9	-----	3.3		
		Y3A	1.9	-----	2.3		
Viewing Angle	2θ _{1/2}		-----	120	-----	deg	I _F =20mA
Reverse Current	I _R		-----	-----	10	μA	V _R =5V

Notes:

1. Tolerance of Luminous Intensity: ±10%.
2. Tolerance of Dominant Wavelength: ±1nm.
3. Tolerance of Forward Voltage: ±0.1V.

■ **Bin Range of Luminous Intensity**

R6A:

Bin Code	Min.	Max.	Unit	Condition
V	715	1120	mcd	I _F =20mA
W	1120	1800		

GH:

Bin Code	Min.	Max.	Unit	Condition
W	1120	1800	mcd	I _F =20mA
X	1800	2850		

Y3A:

Bin Code	Min.	Max.	Unit	Condition
TA	360	565	mcd	I _F =20mA
UA	565	900		

Note:
 Tolerance of Luminous Intensity: ±10%.

■ **Bin Range of Dominant Wavelength**

GH:

Bin Code	Min.	Max.	Unit	Condition
A4	515	520	nm	I _F =20mA
A5	520	525		
A6	525	530		

Y3A :

Bin Code	Min.	Max.	Unit	Condition
YB1	586	588	nm	I _F =20mA
YB2	588	590		
YB3	590	592		
YB4	592	594		

Note:
 Tolerance of Dominant Wavelength: ±1nm

■ **Spectrum Distribution**

R6A:

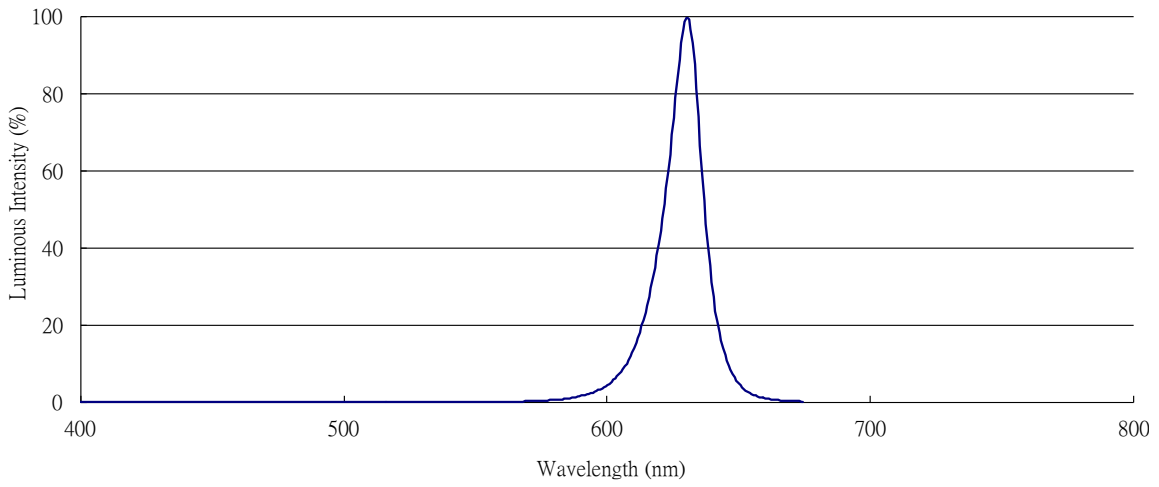

GH:

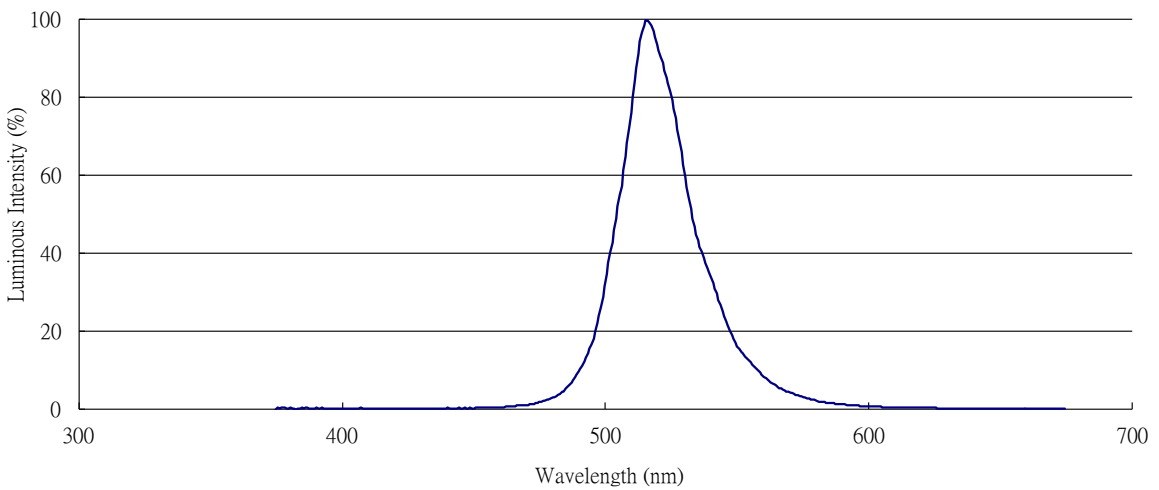

Y3A:

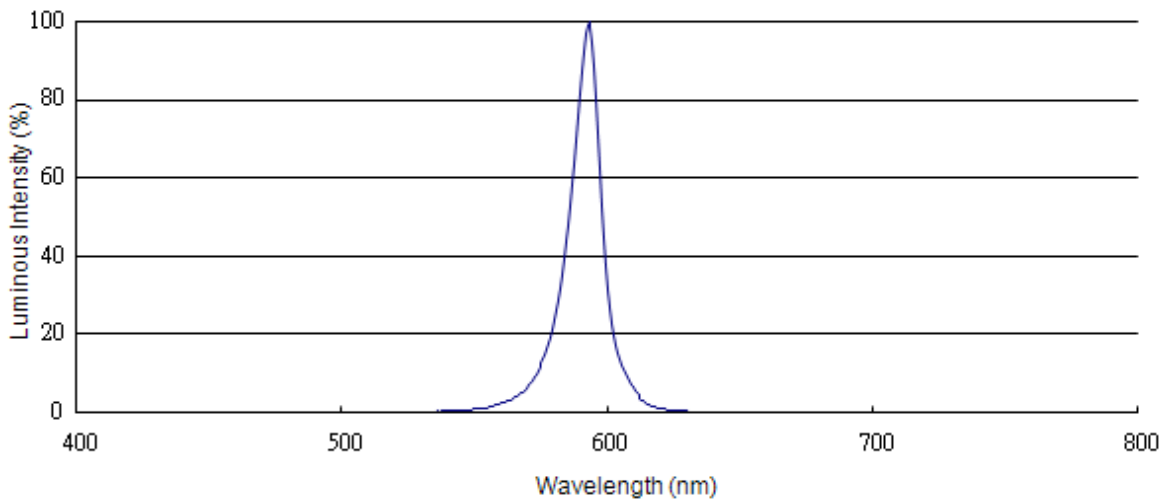

■ **Typical Electro-Optical Characteristics Curves**

R6A/Y3A:

Fig.1-Forward Voltage Shift vs. Junction Temperature

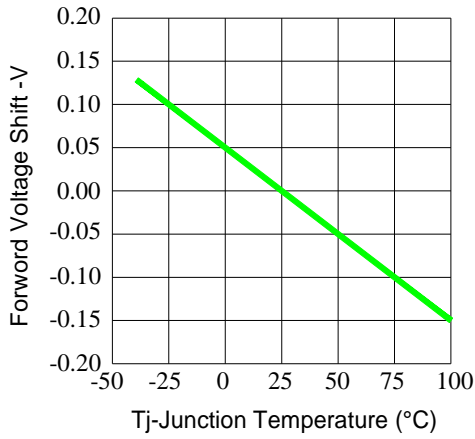

Fig.2-Relative Luminous Intensity vs. Forward Current

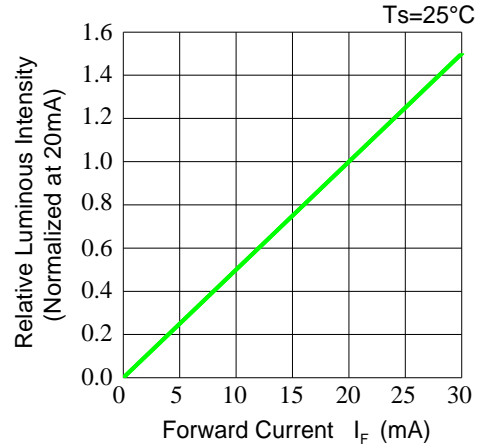

Fig.3-Relative Luminous Intensity vs. Junction Temperature

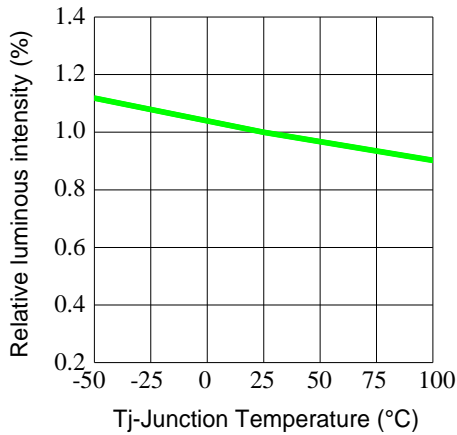

Fig.4-Forward Current vs. Forward Voltage

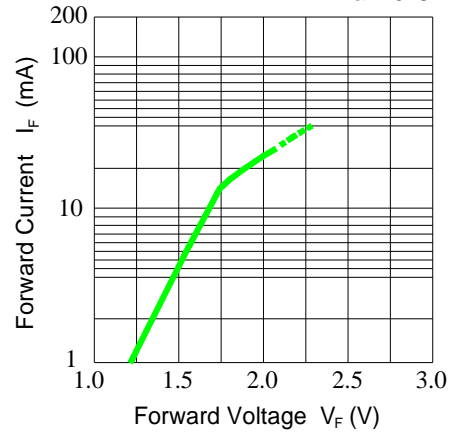

Fig.5-Max. Driving Forward Current vs. Soldering Temperature

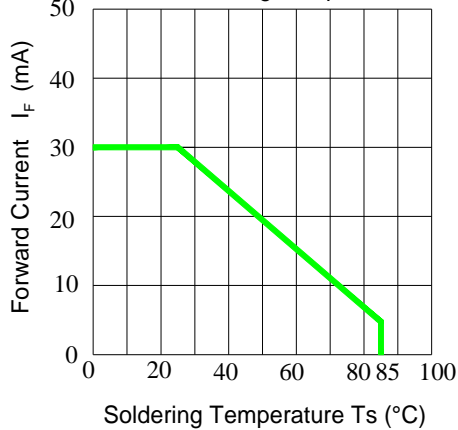
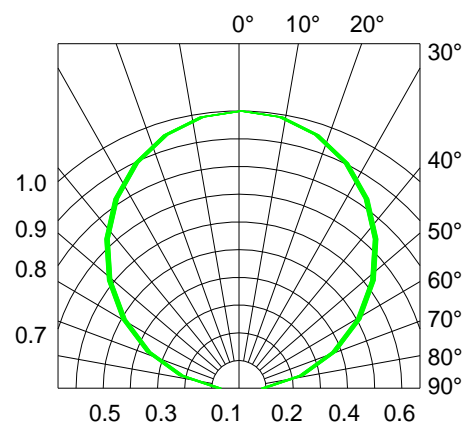

Fig.6-Radiation Diagram



■ **Typical Electro-Optical Characteristics Curves**

GH:

Fig.1-Forward Voltage Shift vs. Junction Temperature

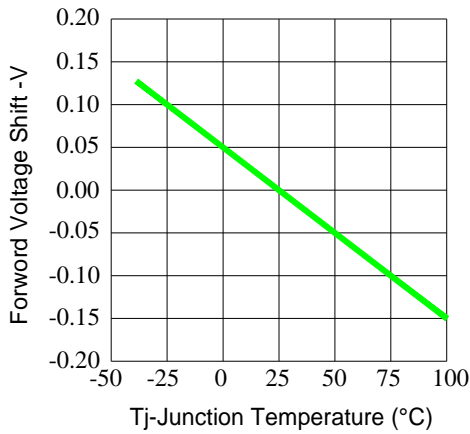

Fig.2-Relative Luminous Intensity vs. Forward Current
 Ts=25°C

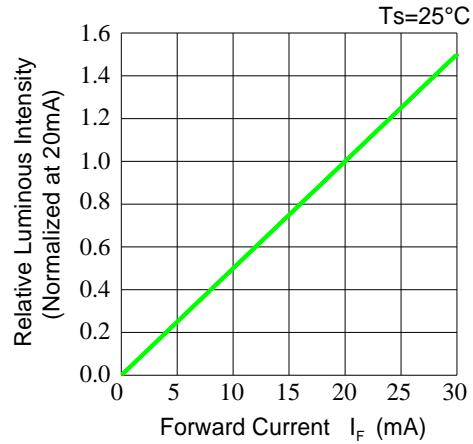

Fig.3-Relative Luminous Intensity vs. Junction Temperature

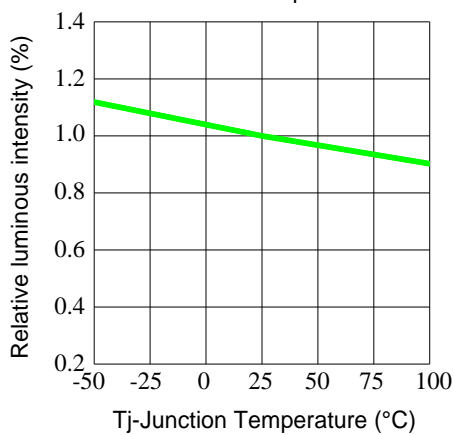

Fig.4-Forward Current vs. Forward Voltage
 Ta=25°C

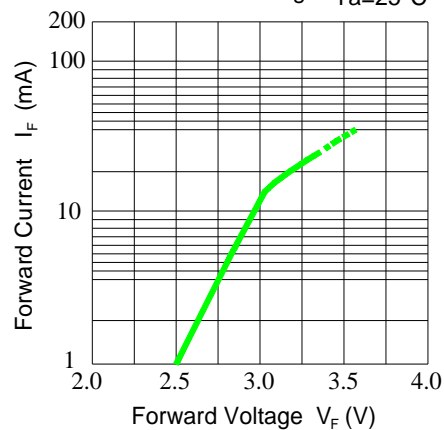

Fig.5-Max. Driving Forward Current vs. Soldering Temperature

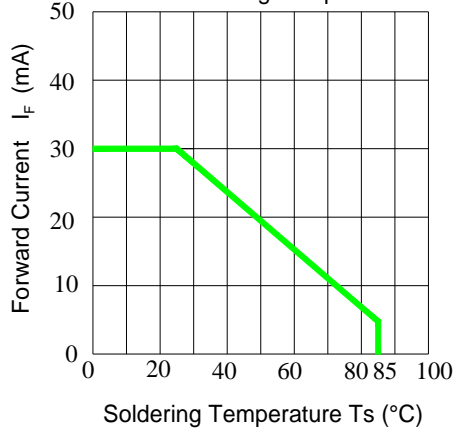
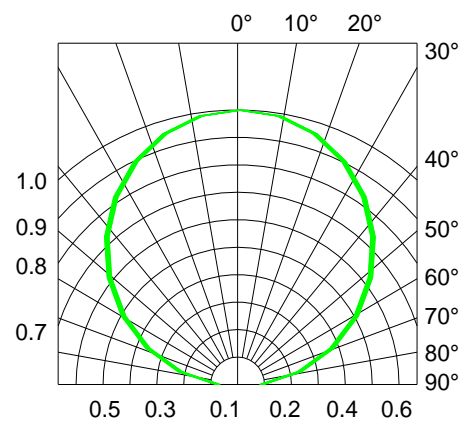



Fig.6-Radiation Diagram Ta=25°C



■ **Moisture Resistant Packing Materials**

Label Explanation



AMICC OPTO-ELECTRONICS
TECHNOLOGY Co.,LTD



P/N: ××××××××××

TYPE: ×-××××××××××

	CODE	MIN	MAX	UNIT
IV:	××	××	××	m cd
HUE:	××	××	××	
VF:	××	××	××	V

LOT NO: ×××××××××× QTY: ××××



MADE IN CHINA

- CPN: Customer's Product Number
- P/N: Product Number
- TYPE :Part NO.
- IV: Luminous Intensity Rank
- WD: Dom. Wavelength Rank
- VF: Forward Voltage Rank
- LOT NO.: Lot Number
- QTY: Packing Quantity

Reel Dimensions

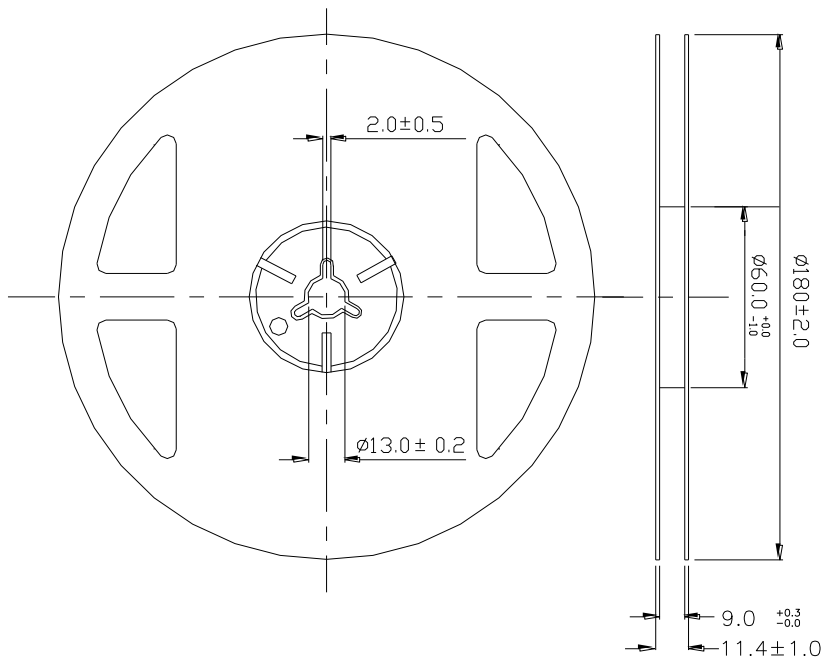

Note:
 Tolerance without mention is ± 0.1 mm.

■ Carrier Tape Dimensions: Loaded Quantity 2000 pcs Per Reel

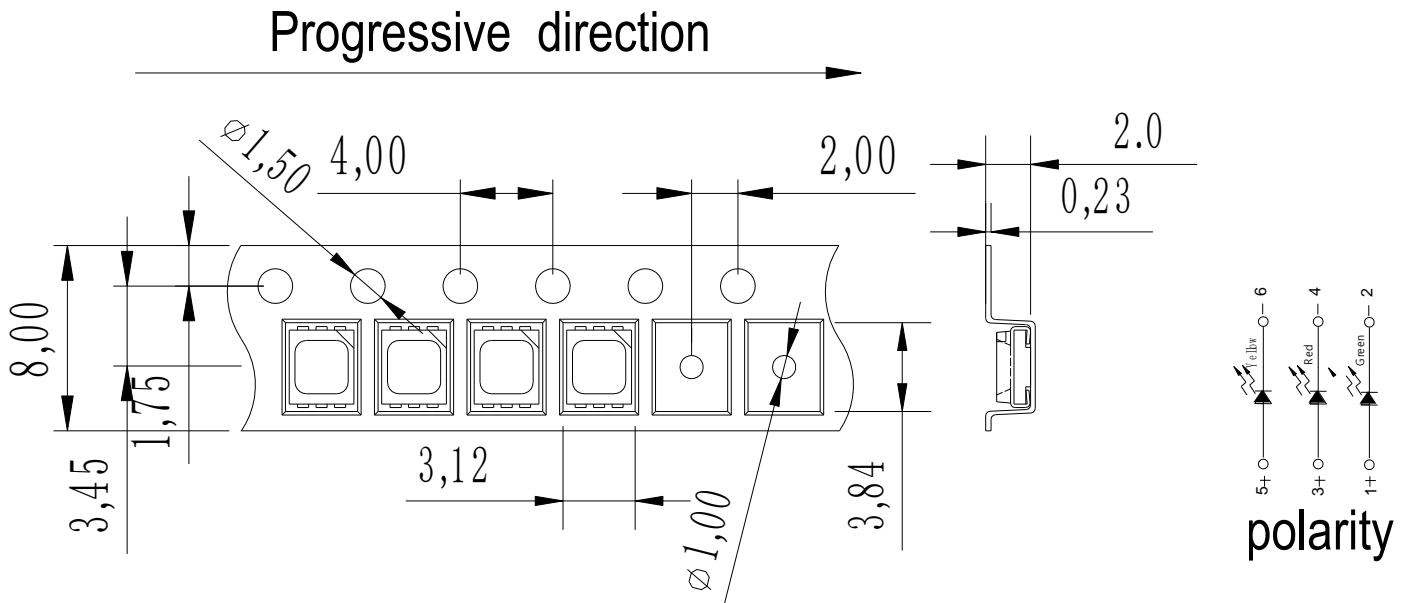

Note:
 Tolerance without mention is $\pm 0.1\text{mm}$.

■ Moisture Resistant Packing Process

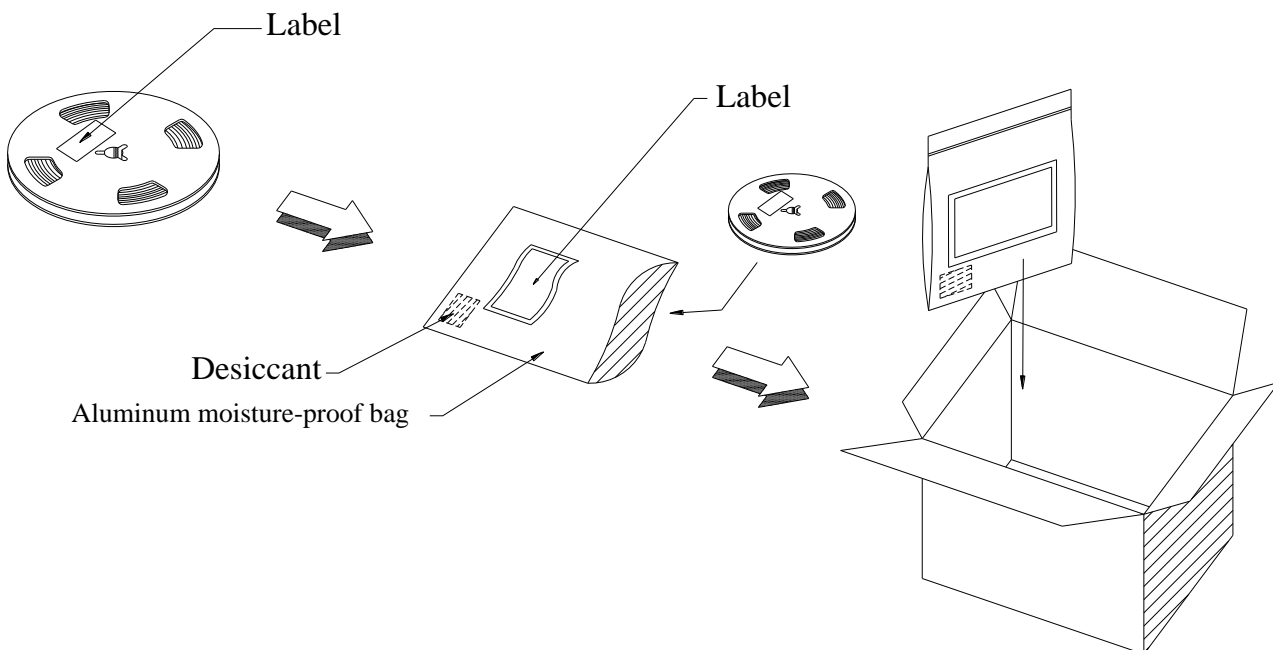

■ **Reliability Test Items and Conditions**

The reliability of products shall be satisfied with items listed below.

Confidence level : 90%

LTPD : 10%

No.	Items	Test Condition	Test Hours/Cycles	Sample Size	Ac/Re
1	Reflow Soldering	Temp. : 260°C/10sec.	6 Min.	22 PCS.	0/1
2	Thermal Shock	H : +100°C 5min ∫ 10 sec L : -10°C 5min	300 Cycles	22 PCS.	0/1
3	Temperature Cycle	H : +100°C 15min ∫ 5 min L : -40°C 15min	300 Cycles	22 PCS.	0/1
4	High Temperature/Humidity	Ta=85°C,85%RH	1000 Hrs.	22 PCS.	0/1
5	Low Temperature Storage	Ta=-40°C	1000 Hrs.	22 PCS.	0/1
6	High Temperature Storage	Ta=100°C	1000 Hrs.	22 PCS.	0/1
7	DC Operation Life	Ta=25°C I _F = 20 mA(Per dice)	1000 Hrs.	22 PCS.	0/1

■ Precautions for Use

1. Over-current-proof

Customer must apply resistors for protection; otherwise slight voltage shift will cause big current change (Burn out will happen).

2. Storage

2.1 Do not open moisture proof bag before the products are ready to use.

2.2 Before opening the package: The LEDs should be kept at 30°C or less and 90%RH or less.

2.3 After opening the package: The LED's floor life is 168 Hrs under 30°C or less and 60% RH or less. If unused LEDs remain, it should be stored in moisture proof packages.

2.4 If the moisture absorbent material (silica gel) has faded away or the LEDs have exceeded the storage time, baking treatment should be performed using the following conditions.

Baking treatment: 60±5°C for 24 hours.

3. Soldering Condition

3.1 Pb-free solder temperature profile

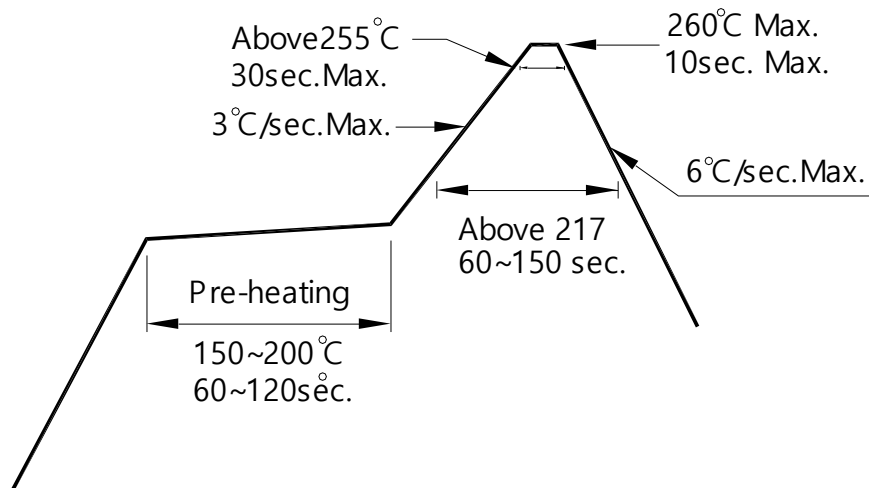

3.2 Reflow soldering should not be done more than two times.

3.3 When soldering, do not put stress on the LEDs during heating.

3.4 After soldering, do not warp the circuit board.

4. Soldering Iron

Each terminal is to go to the tip of soldering iron temperature less than 350°C for 3 seconds within once in less than the soldering iron capacity 25W. Leave two seconds and more intervals, and do soldering of each terminal. Be careful because the damage of the product is often started at the time of the hand solder.

5. Repairing

Repair should not be done after the LEDs have been soldered. When repairing is unavoidable, a double-head soldering iron should be used (as below figure). It should be confirmed beforehand whether the characteristics of the LEDs will or will not be damaged by repairing.

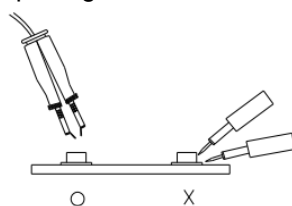

X-ON Electronics

Largest Supplier of Electrical and Electronic Components

Click to view similar products for [Amicc manufacturer](#):

Other Similar products are found below :

[A-SP192GB1D-B01-4T\(HW\)](#) [A-SP1512R6GHC-A01-2A](#) [A-SA3HR334GYRD019](#) [A-SA3HR314GGGGW033-H440](#) [A-SA6S6091RPGCE070-CA](#) [A-SA3HR314GGW026-H22](#) [A-SA3HR324GW014](#) [AM817S\(B\)\(T1\)-FG](#) [A-IRM38G17SC9](#) [A-SA3HR314GD007-H11](#) [A-IA3R326CIR1C-D](#) [A-SA5HR503RG022-H6101](#) [A-SA3R3140RBWE073-CA](#) [A-SP110B1C-C01-2C](#) [A-SA3HR3040SRDN122-H11](#) [A-SA3HR314RGW029-H22](#) [A-SP153IR1C-A02-2D](#) [A-SP192YW1D-D04-4T](#) [A-SI2020R6AGHB1C-C01-2T](#) [AM816S\(B\)\(T1\)-CG](#) [A-SP192CW1D-C06-4T](#) [A-SC6303AR6AGHY3AC-A01-2T](#) [A-SP194R6C-C01-3T](#) [A-SP1103R6AGHB1W-C01-2C](#) [A-SC880IR3C-P03-1T](#) [A-SC667R6AGHB1W-A01-1T](#) [A-SP110W1D-C03-2C](#) [A-SP1502R6W1D-A01-2T](#) [A-SP110R6C-C01-2C](#) [A-SC6302B1R6C-A02-2T](#) [A-SP150B1C-A01-3T](#) [A-SP153IR1C-A02-2T](#) [A-SP1103R6GHB1W-C01-2C](#) [A-SA3R302BWCE062-30](#) [A-SA3R3040BWCE061](#) [A-SL660B1C-C01-4T](#) [A-SP170B1C-C02-3T](#) [A-SP150Y3AC-A01-3T](#) [A-SP192GS1D-C01-4T](#) [A-SP1102DR6W1D-C01-2C](#) [A-SP1923XR6GHB1C-A01-3T](#) [A-SP110GHC-C01-2C](#) [A-SP110W1D-C01-2C](#) [A-SC6303R6AGHB1C-A01-2T](#) [A-SP1942R5G2C-C01-2T](#) [A-SP158IR1C-A02-2D](#) [A-SP192YR6C-A01-4T](#) [A-SC6302R6AGHC-A03-2T](#) [A-SP150R6AC-A01-3T](#) [A-SP194ZW1D-C07-4T](#)