

客户 (Customer) : _____

承认书

Approval Sheet

谨致执事者：兹提供敝公司之有关详细规格及图面数据,敬请给予办理试认定手续。
同时敬请送返一份附有贵公司签认之测试认定后之样品承认书。

We are pleased in sending you herewith on specification and drawings for your approval.
Please return to us one copy "Approval sheet" with your approved signature.

型号 (Model No.) : A-SC6303R6GHB1C-A01-2T

发文日期 (Issue Date) : 2021/04/28 承认日期 (Approved Date) : _____

Checking signature of Amicc

Designer	Checker	Approver
Mars	<i>Tommy</i>	Solarliu

Approval signature of customer

Designer	Checker	Approver

江苏欧密格光电科技股份有限公司

Jiangsu Amicc Opto-Electronics Technology Co.,Ltd.

地址:江苏省常州市武进区武南中路 98 号

Add: 98.Wu Nan Road, Wujin, Changzhou city, Jiangsu Province

TEL:0086-519-89806973

FAX:0086-519-86523668

Top view LED Type ■ PLCC Package

A-SC6303R6GHB1C-A01-2T



■ Features

- PLCC package
- Top view white LED
- High luminous Intensity output
- Wide viewing angle
- Pb-free
- RoHS compliant
- JEDEC MSL 3

■ Description

The Amicc 6303 package has high efficacy, high power consumption, wide viewing angle and a compact form factor. These features make this package an ideal LED for all lighting applications.

■ Applications

- General lighting
- Decorative and Entertainment Lighting
- Indicators
- Illumination
- Switch light

■ Device Selection Guide

Type	Chip Materials	Emitted Color	Resin Color
R6	AlGaInP	Brilliant Red	Water Clear
GH	InGaN	Green	
B1	InGaN	Blue	

■ **Absolute Maximum Ratings (T_{Soldering}=25°C)**

Parameter	Symbol	Color	Rating	Unit
Forward Current	I _F	R6	25	mA
		GH	30	
		B1	30	
Peak Forward Current (Duty 1/10 @1ms)	I _{FP}	R6	100	mA
		GH	100	
		B1	100	
Power Dissipation	P _d	R6	70	mW
		GH	95	
		B1	95	
Electrostatic Discharge(HBM)	ESD	R6	2000	V
		GH	2000	
		B1	2000	
Operating Temperature	T _{opr}		-40 ~ +85	°C
Storage Temperature	T _{stg}		-40 ~ +100	°C
Soldering Temperature	T _{sol}		Reflow Soldering : 260 °C for 10 sec. Hand Soldering : 350 °C for 3 sec.	

Note:

The products are sensitive to static electricity and must be carefully taken when handling products.

■ **Electro-Optical Characteristics (T_{Soldering}=25°C)**

Parameter	Symbol	Color	Min.	Typ.	Max.	Unit	Condition
Luminous Intensity	I _v	R6	225	-----	450	mcd	I _F =20mA (R6)
		GH	1120	-----	2250		I _F =20mA (GH)
		B1	285	-----	715		I _F =20mA (B1)
Peak Wavelength	λ _p	R6	-----	622	-----	nm	I _F =20mA (R6)
		GH	-----	523	-----		I _F =20mA (GH)
		B1	-----	452	-----		I _F =20mA (B1)
Dominant Wavelength	λ _d	R6	-----	622	-----	nm	I _F =20mA (R6)
		GH	515	525	530		I _F =20mA (GH)
		B1	460	465	470		I _F =20mA (B1)
Forward Voltage	V _F	R6	1.7	-----	2.3	V	I _F =20mA (R6)
		GH	2.7	-----	3.3		I _F =20mA (GH)
		B1	2.7	-----	3.3		I _F =20mA (B1)
Viewing Angle	2θ _{1/2}		-----	120	-----	deg	I _F =20mA (R6) I _F =20mA (GH) I _F =20mA (B1)
Reverse Current	I _R		-----	-----	5	μA	V _R =5V

Notes:

- 1.Tolerance of Luminous Intensity: ±10%.
- 2.Tolerance of Dominant Wavelength: ±1nm
- 3.Tolerance of Forward Voltage : ±0.1V.

■ **Bin Range of Luminous Intensity**

R6:

Bin Code	Min.	Max.	Unit	Condition
AS2	225	285	mcd	I _F =20mA
AT1	285	360		
AT2	360	450		

GH:

Bin Code	Min.	Max.	Unit	Condition
AW1	1120	1420	mcd	I _F =20mA
AW2	1420	1800		
AX1	1800	2250		

B1:

Bin Code	Min.	Max.	Unit	Condition
T	285	450	mcd	I _F =20mA
U	450	715		

Note:
 Tolerance of Luminous Intensity: ±10%.

Bin Range of Dominant Wavelength

GH:

Bin Code	Min.	Max.	Unit	Condition
A4	515.0	520.0	nm	I _F =20mA
A5	520.0	525.0		
A6	525.0	530.0		

B1 :

Bin Code	Min.	Max.	Unit	Condition
A5	460.0	465.0	nm	I _F =20mA
A6	465.0	470.0		

Note:
 Tolerance of Dominant Wavelength: ±1nm

■ **Spectrum Distribution**

R6:

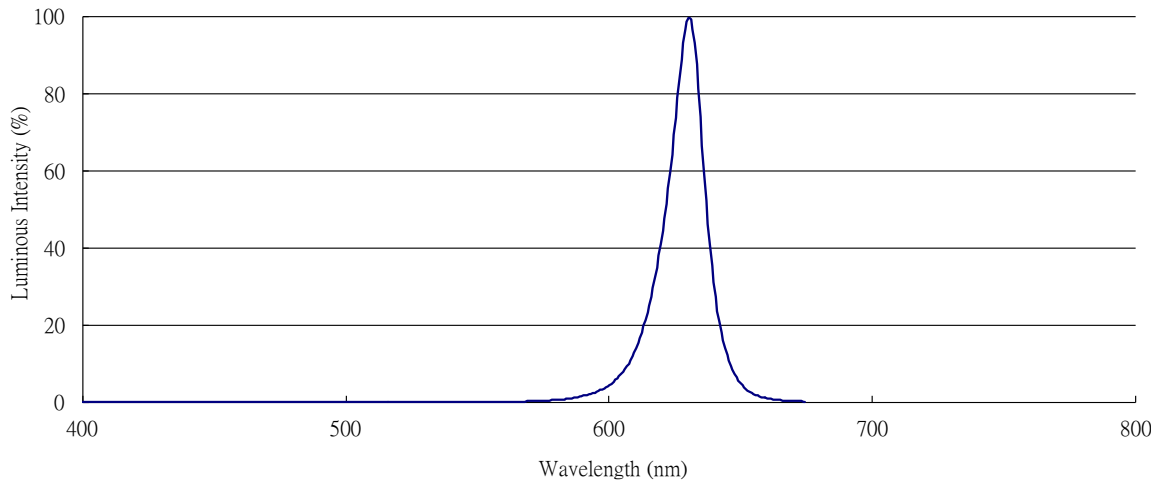

GH:

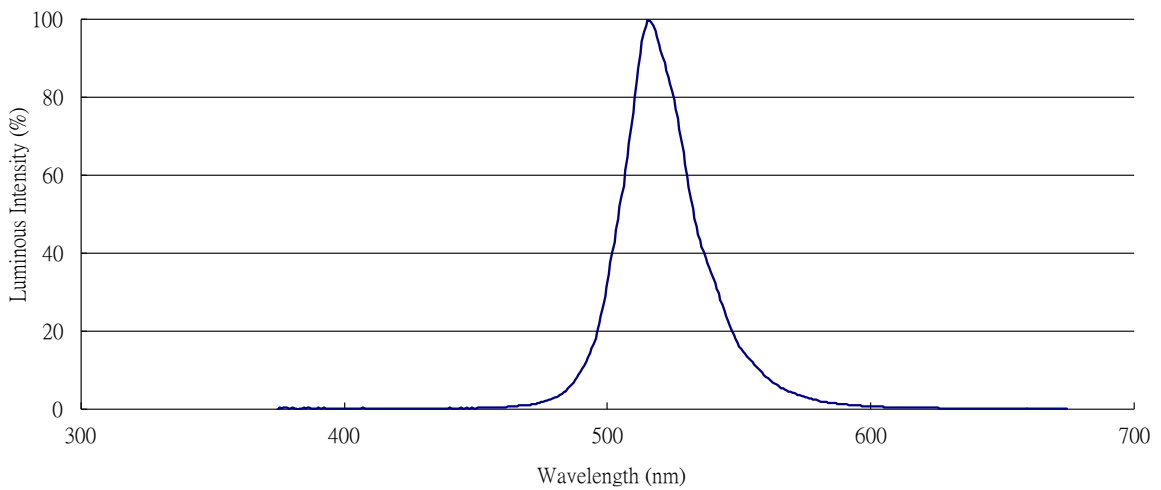

B1:

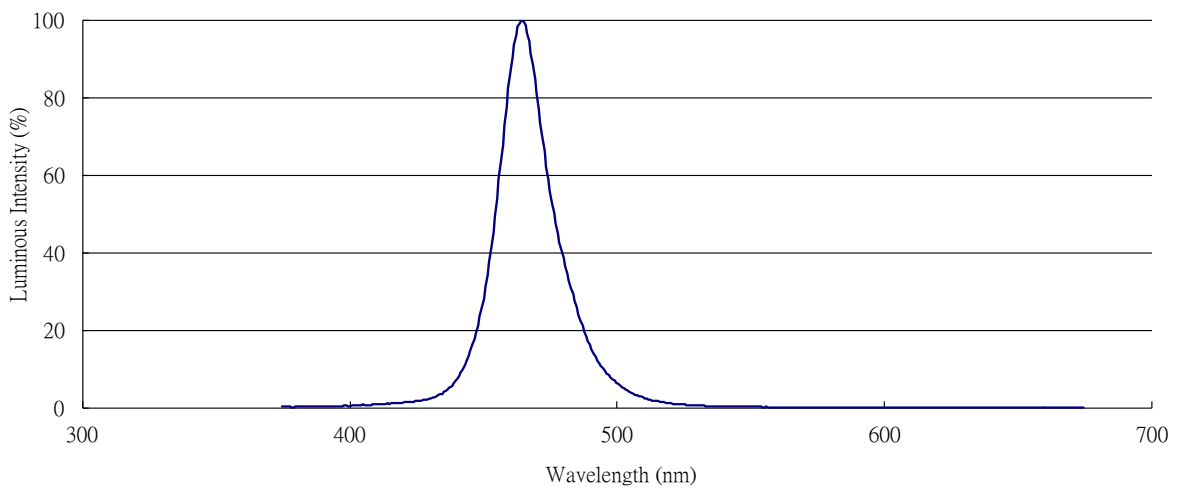

■ **Typical Electro-Optical Characteristics Curves**

R6:

Fig.1-Forward Voltage Shift vs. Junction Temperature

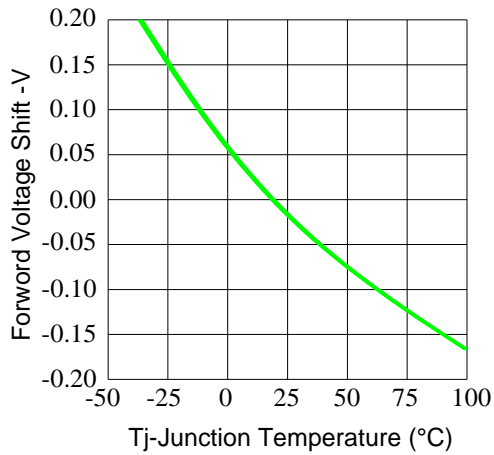

Fig.2-Relative Luminous Intensity vs. Forward Current

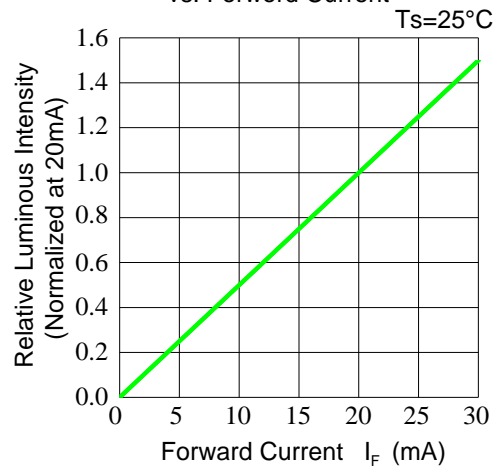

Fig.3-Relative Luminous Intensity vs. Junction Temperature

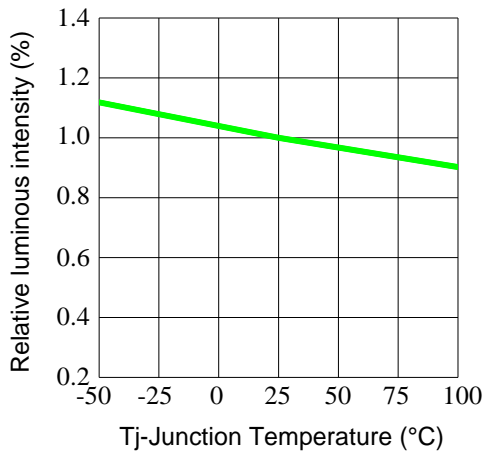

Fig.4-Forward Current vs. Forward Voltage

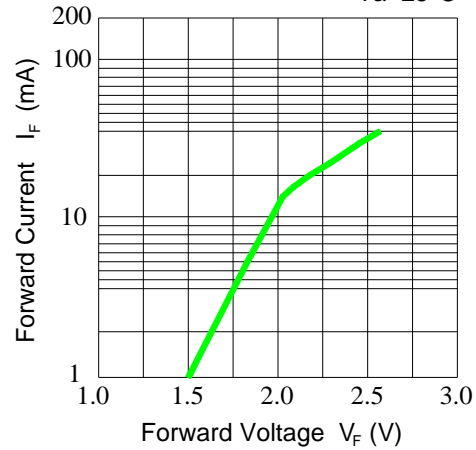

Fig.5-Max. Driving Forward Current vs. Soldering Temperature

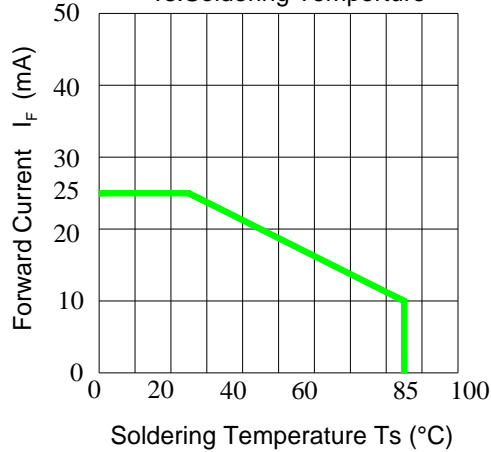
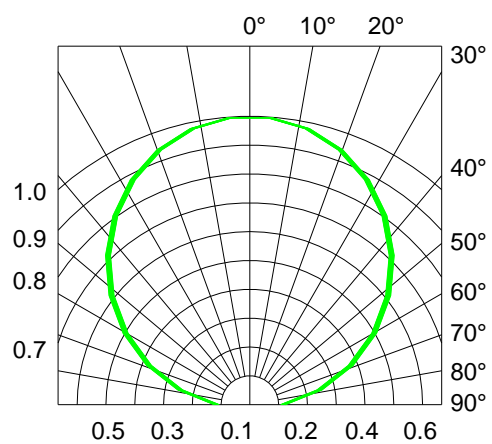

Fig.6-Radiation Diagram



■ **Typical Electro-Optical Characteristics Curves**

GH:

Fig.1-Forward Voltage Shift vs. Junction Temperature

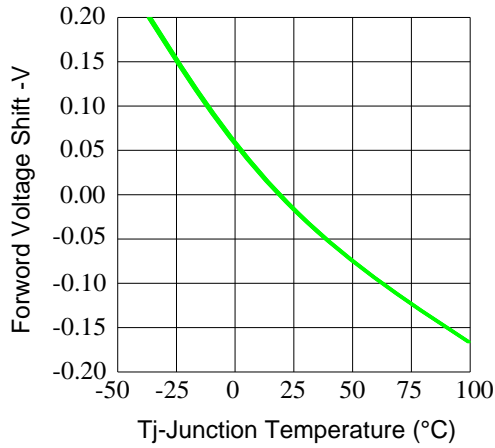

Fig.2-Relative Luminous Intensity vs. Forward Current

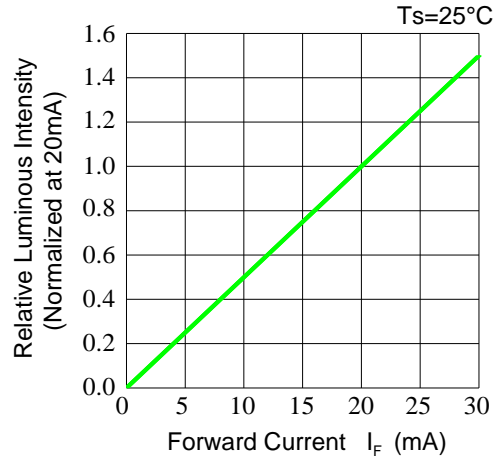

Fig.3-Relative Luminous Intensity vs. Junction Temperature

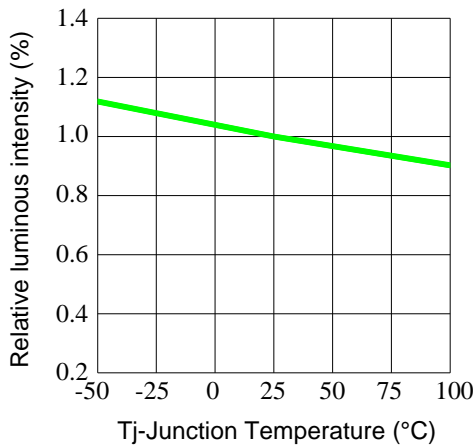

Fig.4-Forward Current vs. Forward Voltage

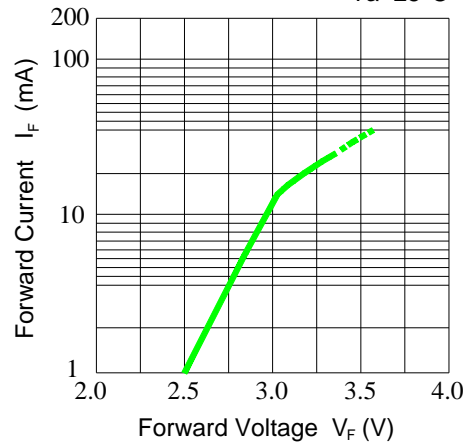

Fig.5-Max. Driving Forward Current vs. Soldering Temperature

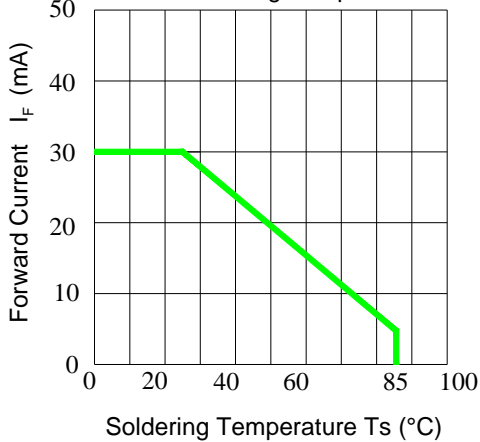
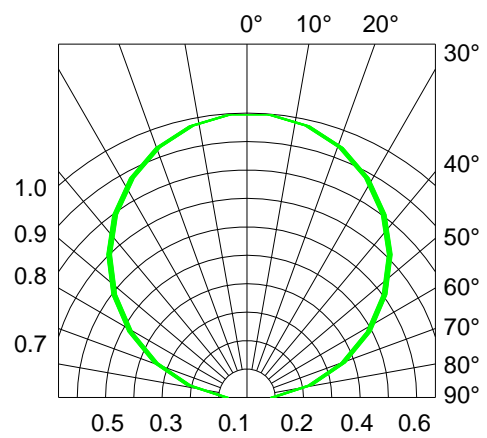

Fig.6-Radiation Diagram



■ **Typical Electro-Optical Characteristics Curves**

B1

Fig.1-Forward Voltage Shift vs. Junction Temperature

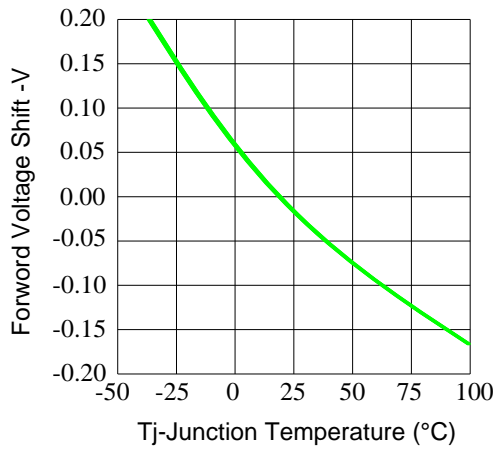

Fig.2-Relative Luminous Intensity vs. Forward Current

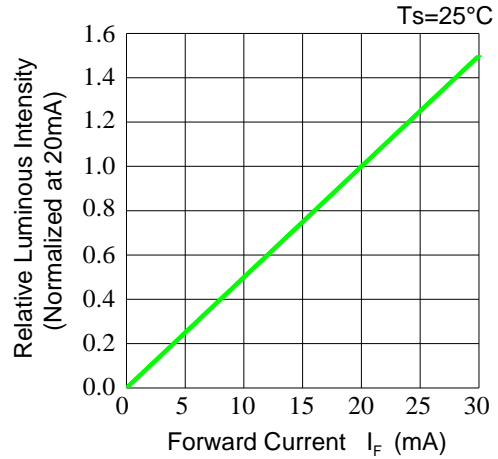

Fig.3-Relative Luminous Intensity vs. Junction Temperature

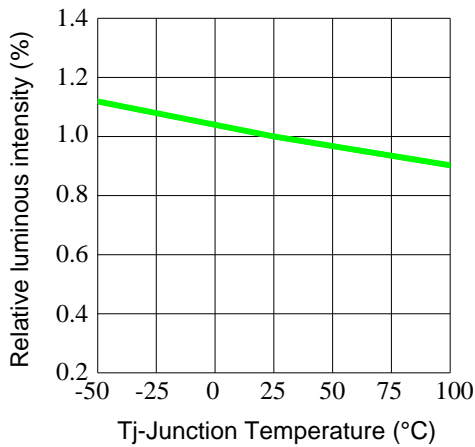

Fig.4-Forward Current vs. Forward Voltage

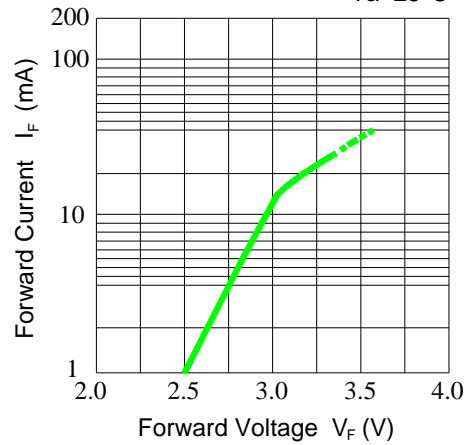

Fig.5-Max. Driving Forward Current vs. Soldering Temperature

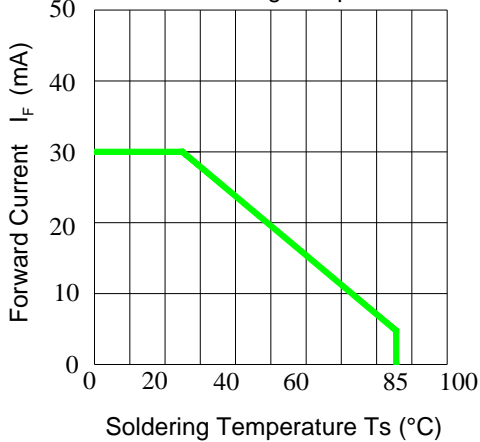
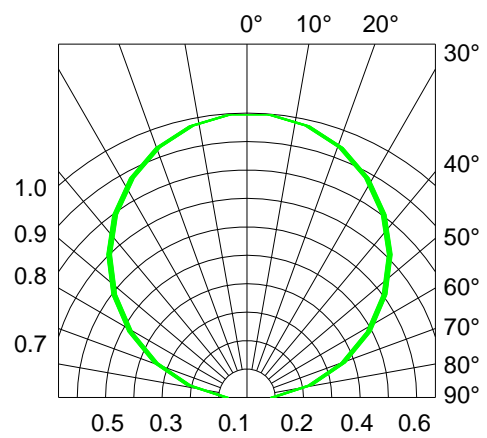
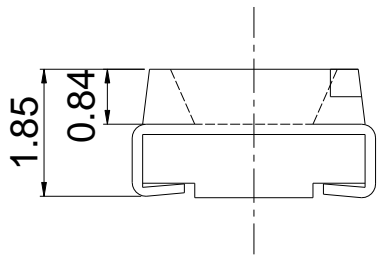
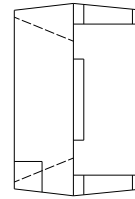
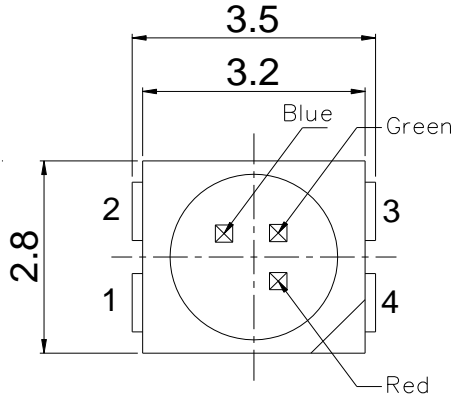

Fig.6-Radiation Diagram



■ Package Dimension



Polarity

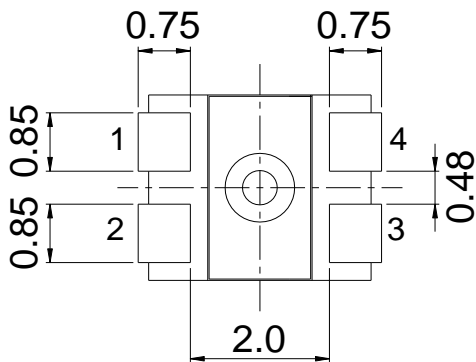
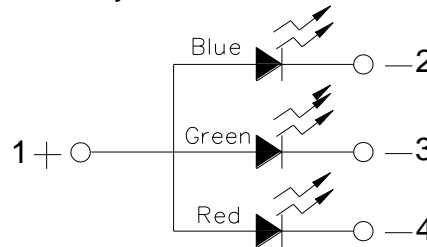

Recommended solder pad

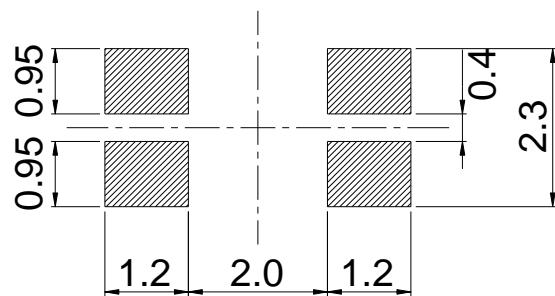

Note:
 Tolerance unless mentioned is ± 0.1 mm, Unit = mm

■ **Moisture Resistant Packing Materials**

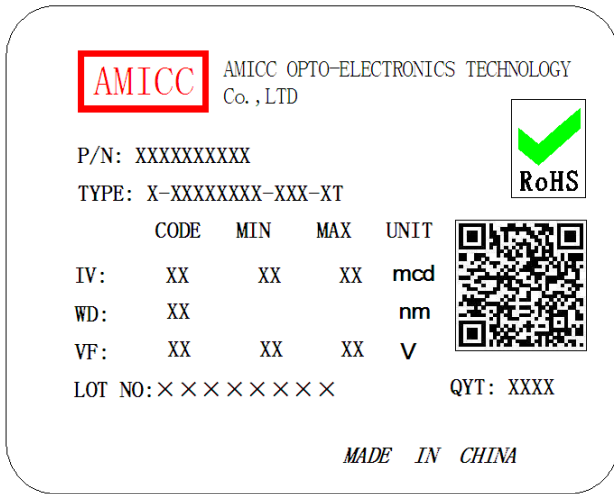

- CPN: Customer's Product Number
- P/N: Product Number
- TYPE :Part NO.
- IV: Luminous Intensity Rank
- WD: Dom. Wavelength Rank
- VF: Forward Voltage Rank
- LOT NO.: Lot Number
- QTY: Packing Quantity

Reel Dimensions

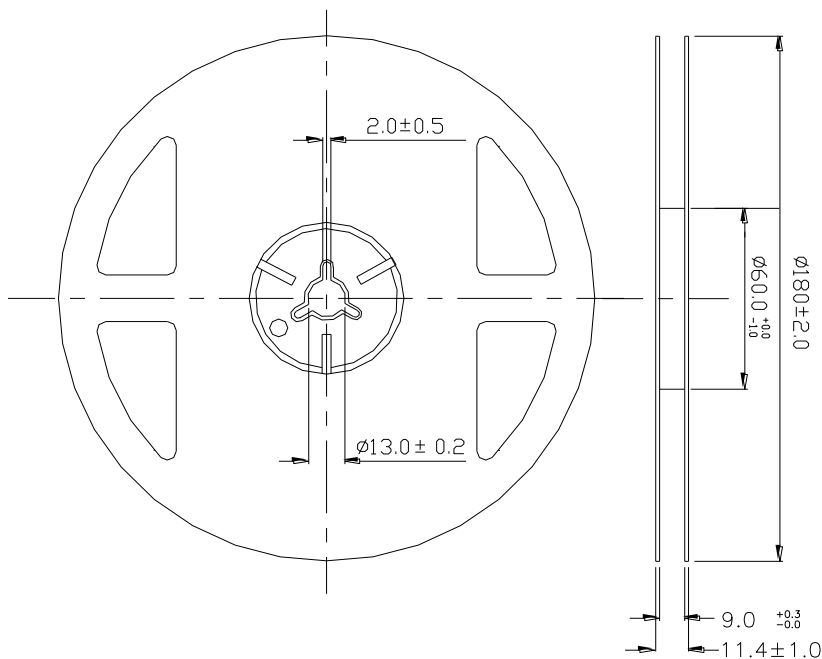

Note:
 Tolerances unless mentioned ± 0.1 mm, Unit = mm

Carrier Tape Dimensions: Loaded Quantity 2000 pcs Per Reel

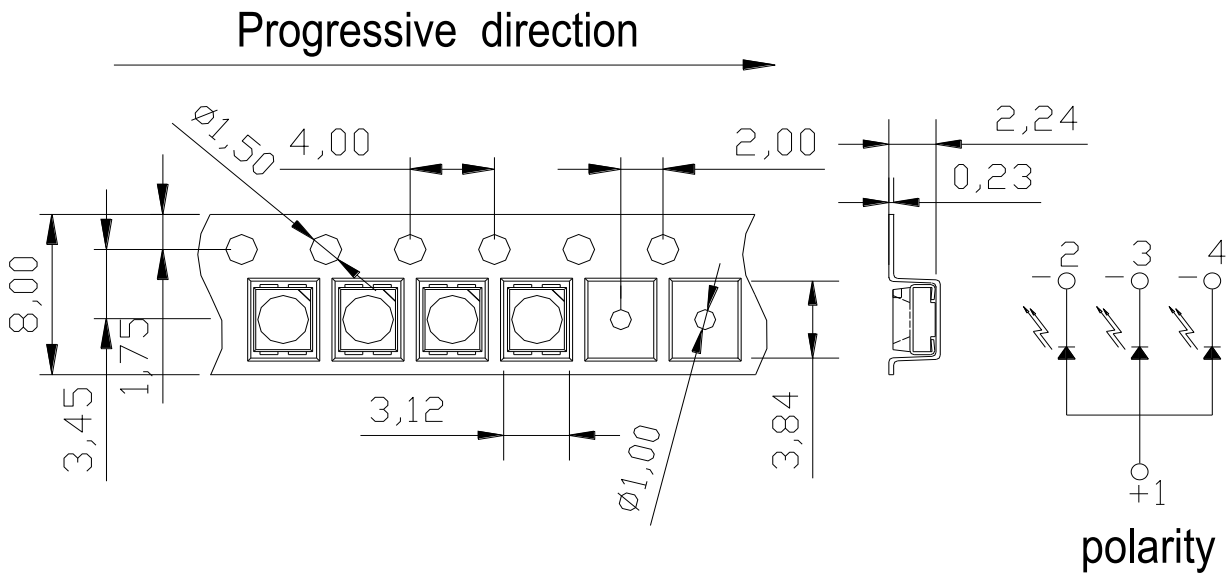

Note:
 Tolerance unless mentioned is ± 0.1 mm, Unit = mm

Moisture Resistant Packing Process

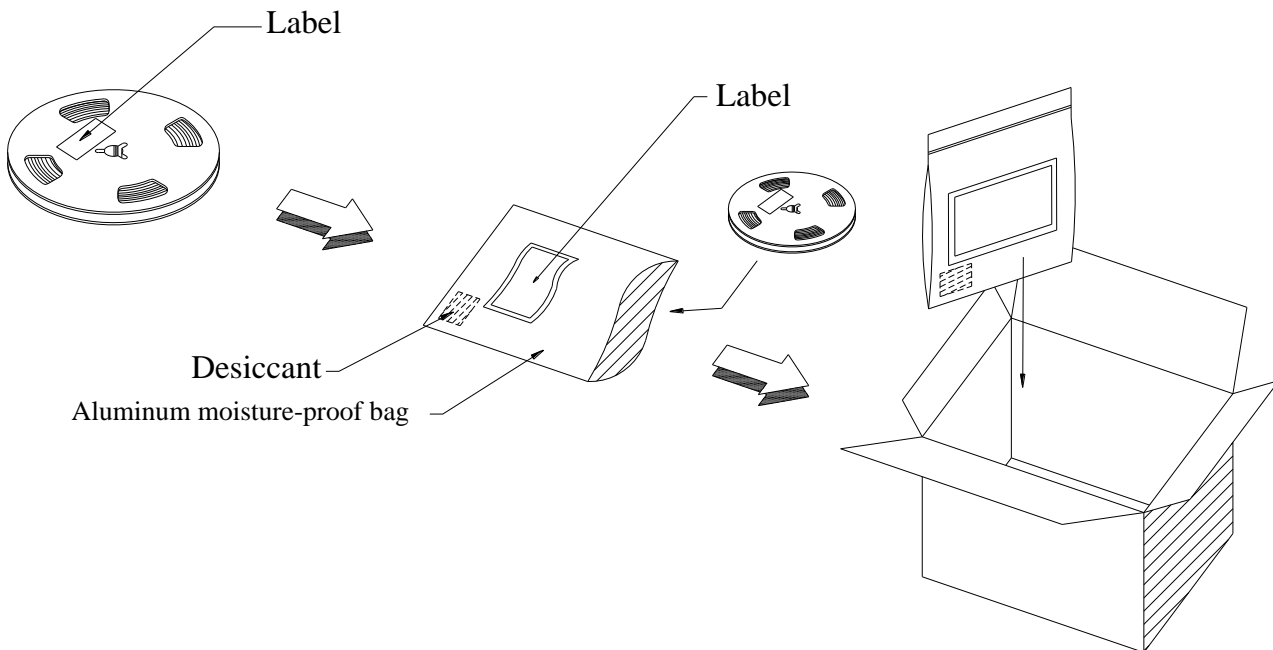

■ **Reliability Test Items and Conditions**

The reliability of products shall be satisfied with items listed below.

Confidence level : 90%

LTPD : 10%

No.	Items	Test Condition	Test Hours/Cycles	Sample Size	Ac/Re
1	Reflow Soldering	Temp. : 260°C/10sec.	6 Min.	22 PCS.	0/1
2	Thermal Shock	H : +100°C 5min ∫ 10 sec L : -10°C 5min	300 Cycles	22 PCS.	0/1
3	Temperature Cycle	H : +100°C 15min ∫ 5 min L : -40°C 15min	300 Cycles	22 PCS.	0/1
4	High Temperature/Humidity Reverse Bias	Ta=85°C,85%RH	1000 Hrs.	22 PCS.	0/1
5	Low Temperature Storage	Ta=-40°C	1000 Hrs.	22 PCS.	0/1
6	High Temperature Storage	Ta=100°C	1000 Hrs.	22 PCS.	0/1
7	DC Operation Life	Ta=25°C I _F = 20 mA(Per dice)	1000 Hrs.	22 PCS.	0/1

■ Precautions for Use

1. Over-current-proof

Customer must apply resistors for protection; otherwise slight voltage shift will cause big current change (Burn out will happen).

2. Storage

2.1 Do not open moisture proof bag before the products are ready to use.

2.2 Before opening the package: The LEDs should be kept at 30°C or less and 90%RH or less.

2.3 After opening the package: The LED's floor life is 168 Hrs under 30°C or less and 60% RH or less. If unused LEDs remain, it should be stored in moisture proof packages.

2.4 If the moisture absorbent material (silica gel) has faded away or the LEDs have exceeded the storage time, baking treatment should be performed using the following conditions.

Baking treatment: 60±5°C for 24 hours.

3. Soldering Condition

3.1 Pb-free solder temperature profile

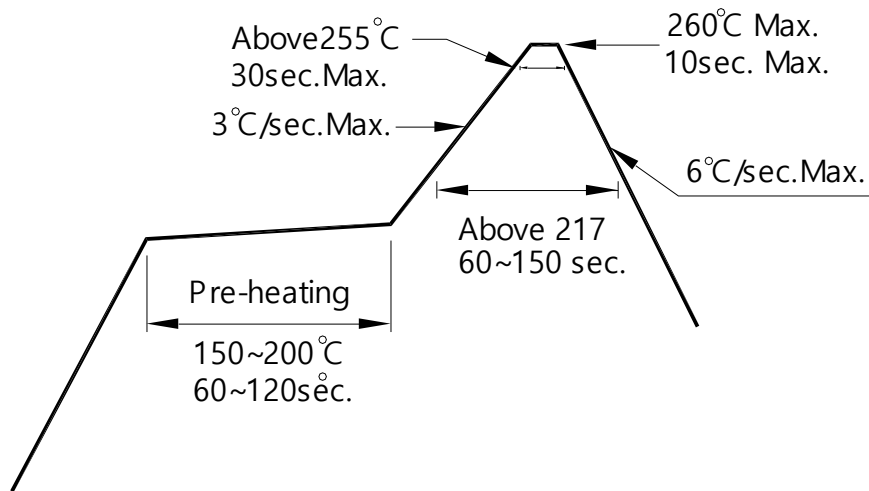

3.2 Reflow soldering should not be done more than two times.

3.3 When soldering, do not put stress on the LEDs during heating.

3.4 After soldering, do not warp the circuit board.

4. Soldering Iron

Each terminal is to go to the tip of soldering iron temperature less than 350°C for 3 seconds within once in less than the soldering iron capacity 25W. Leave two seconds and more intervals, and do soldering of each terminal. Be careful because the damage of the product is often started at the time of the hand solder.

5. Repairing

Repair should not be done after the LEDs have been soldered. When repairing is unavoidable, a double-head soldering iron should be used (as below figure). It should be confirmed beforehand whether the characteristics of the LEDs will or will not be damaged by repairing.

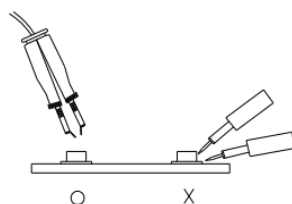

X-ON Electronics

Largest Supplier of Electrical and Electronic Components

Click to view similar products for [Standard LEDs - SMD category](#):

Click to view products by [Amicc manufacturer](#):

Other Similar products are found below :

[LTST-C190KYKT](#) [LTST-C19GD2WT](#) [LTW-170ZDC](#) [LTW-M140SZS40](#) [LTW-M140ZVS](#) [598-8110-100F](#) [598-8610-202F](#) [91-21SUBCS400-A6TR7](#) [QBLP653-IW](#) [QBLP674-IWM-WW](#) [AAAF5060QBFSEEZGS](#) [APT1608QGW](#) [99-213/R6C-AR2T1B/2C](#) [SML-512VWT86A](#) [SML-LX0606SISUGC/A](#) [SML-LXR851SIUPGUBC](#) [LT1ED53A](#) [APFA3010SURKCGKQBDC](#) [APHK1608VGCA](#) [APT2012QGW](#) [LTST-008BGEW](#) [LTW-010DCG](#) [LTW-21TS5](#) [LTW-220DS5](#) [598-8330-117F](#) [65-21SYGC/S530-E3/TR8](#) [CMDA20AYAA7D1S](#) [95-21SURCS530-A3TR10](#) [598-8070-100F](#) [598-8140-100F](#) [598-8610-200F](#) [SML-LXR851SGSIC-TR](#) [SML-512PWT86A](#) [SMF-2432GYC-TR](#) [EASV3015RGYA0](#) [95-21UYC-S530-A5-TR7](#) [LTST-C194TBKT-5A](#) [CLX6E-FKC-CH1M1D1BB7C3D3](#) [SML-LXL0805USBC-TR](#) [SML-LX2835SYSUGCTR](#) [LTW-M670ZVS-M5](#) [APA2106ZGC/G](#) [CLMXB-FKA-CbcfghjnpACBB79463](#) [KPTD-2012LVVBC-D](#) [VFA1101W-5AY3B2-TR](#) [LCB P473-P2R2-3J7L-1-Z](#) [91-21VGC/S556/S68/TR10/S370](#) [LW A67C-S2U1-FK0KM0](#) [LW A673-P1S1-FK0PM0](#) [BL-HE1G033B-TRB](#)