

客户 (Customer) : _____

承认书

Approval Sheet

谨致执事者：兹提供敝公司之有关详细规格及图面数据，敬请给予办理试认定手续。

同时敬请送返一份附有贵公司签认之测试认定后之样品承认书。

We are pleased in sending you herewith on specification and drawings for your approval.
Please return to us one copy "Approval sheet" with your approved signature.

型号 (Model No.) : A-SI2020R6AGHB1C-C01-2T

发文日期 (Issue Date) : 2023/10/16 承认日期 (Approved Date) : _____

Checking signature of Amicc

Designer	Checker	Approver
Katryn		

Approval signature of customer

Designer	Checker	Approver

江苏欧密格光电科技股份有限公司

Jiangsu AMICC Opto-Electronics Technology CO.,LTD.

江苏省常州市武进区武南中路 98 号

No. 98, Wu Nan Road, Wujin, Changzhou city, Jiangsu province

TEL:0086-519-89806999

FAX:0086-519-86523668

LED Built-in IC Type ■ Top view Full-color 2020 Package

A-SI2020R6AGHB1C-C01-2T

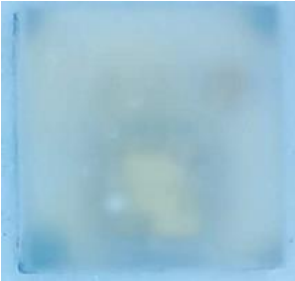

Features

- Top SMD integrated with high quality external control single line serial cascade constant current IC.
- Support for single wire communication, serial connection.
- Constant current output current 5mA.
- Grayscale adjustable circuit 256 grayscale adjustable.
- Display data double latch, transfer data does not affect display.
- Single line data transmission, unlimited cascade.
- Built-in high-precision oscillator.
- Display maximum refresh rate up to 4.5Khz.
- Pb-free
- RoHS compliant

Applications

- Full color LED string light, LED full color module
- LED super hard and soft lights, LED appearance / scene lighting
- LED point light source, LED pixel screen
- LED shaped screen, Electrical equipment Marquee

Package Dimensions

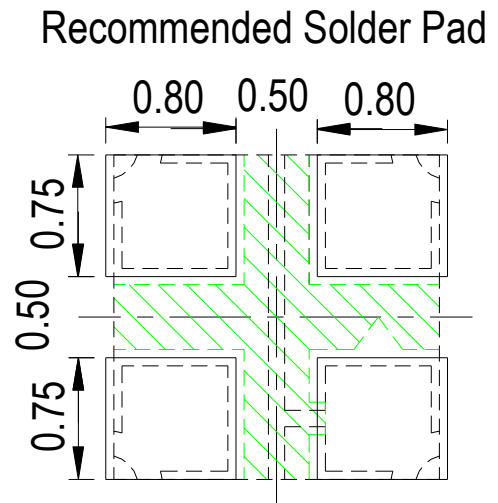
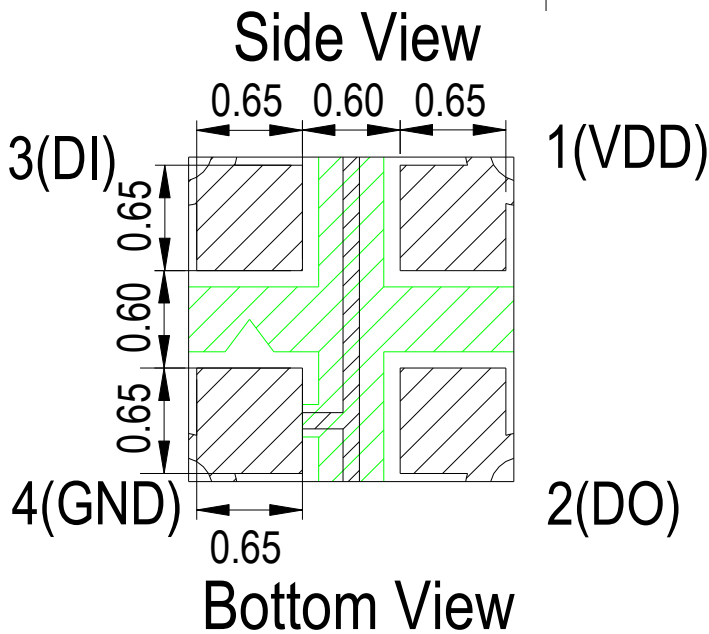
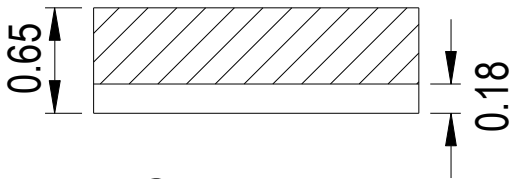
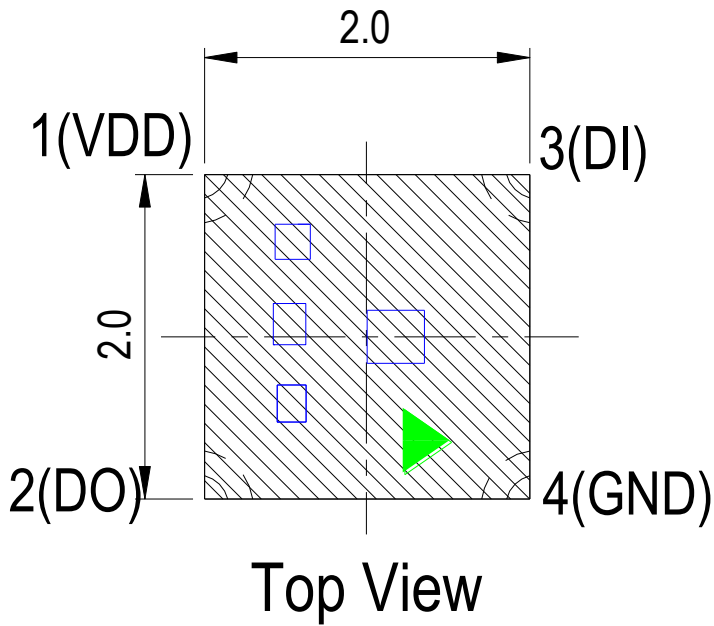

Note:
 Tolerance unless mentioned is ± 0.1 mm, Unit = mm

Pin diagram and functions:

NO.	Symbol	Pin name	Function description
1	VDD	Power Supply	5V
3	DI	Data input	Built-in Pull down resistance
4	GND	Ground	Signal ground
2	DO	Data output	Built-in Pull down resistance@input mode

Electrical Characteristics (Limit parameter, Ta=25°C , VDD=12V, VSS=0V)

Parameter	Symbol	Range	Company
Voltage	VDD	-0.4~+5.4	V
Logic input voltage	Vi	-0.4~VDD+0.4	V
Working temperature	Topt	-40~+85	°C
Storage temperature	Tstg	-40~+100	°C
ESD(Human Body Model)	VESD	2000	V

RGB LED Photoelectric parameters

Color	If=5mA	
	Dominate Wavelengt(nm)	Iv (mcd)
R	615~630	57~140
G	515~535	180~450
B	460~475	36~90

Typical Electro-Optical Characteristics Curve(Chip code: R6A)

Fig.1-Relative Luminous Intensity vs.Junction Temperature

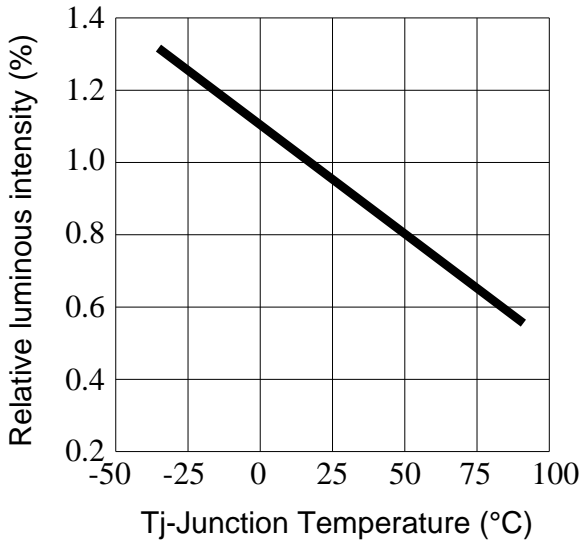

Fig.2-Relative Luminous Intensity vs. Forward Current

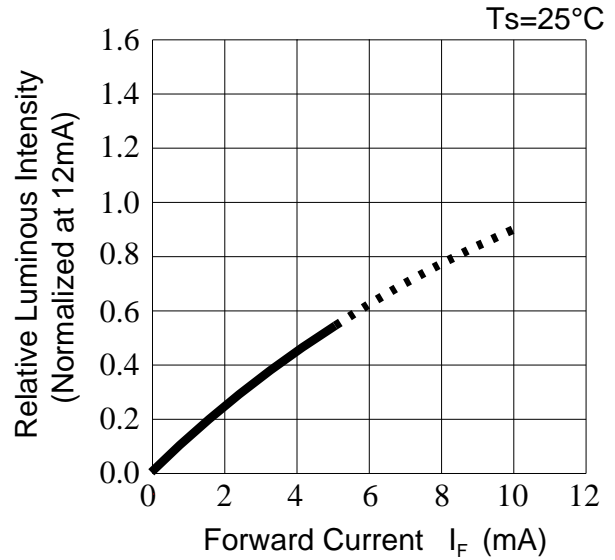

Fig.3-Max.Driving Forward Current vs.Soldering Temperature

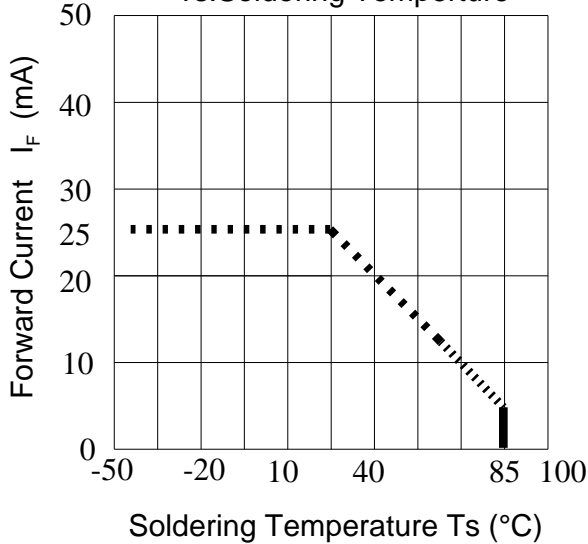
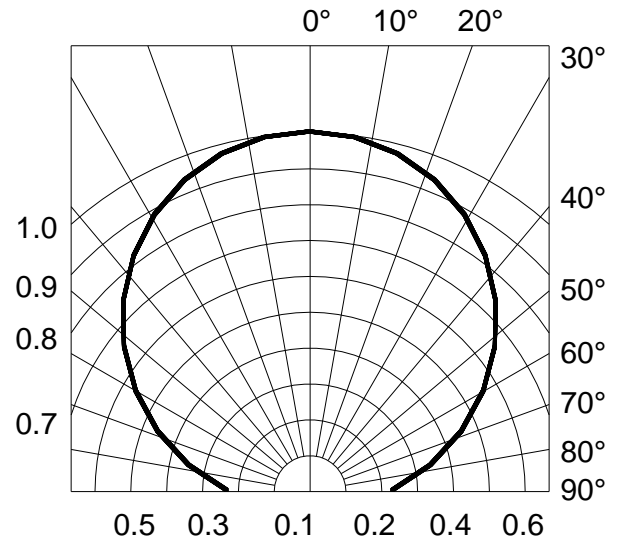

Fig.4-Radiation Diagram $T_a=25^\circ\text{C}$



Typical Electro-Optical Characteristics Curve(Chip code: GH/B1)

Fig.1-Relative Luminous Intensity vs.Junction Temperature

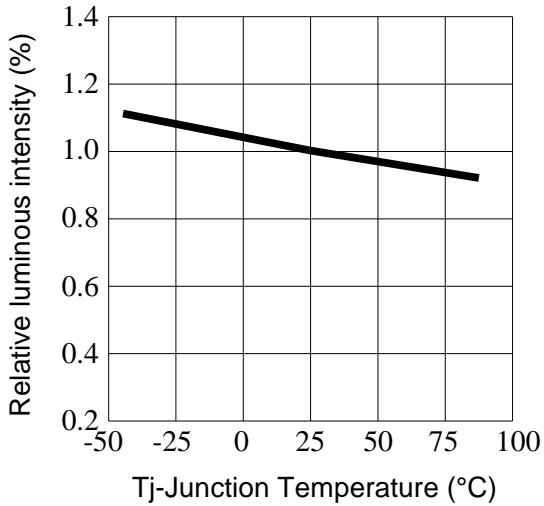

Fig.2-Relative Luminous Intensity vs. Forward Current

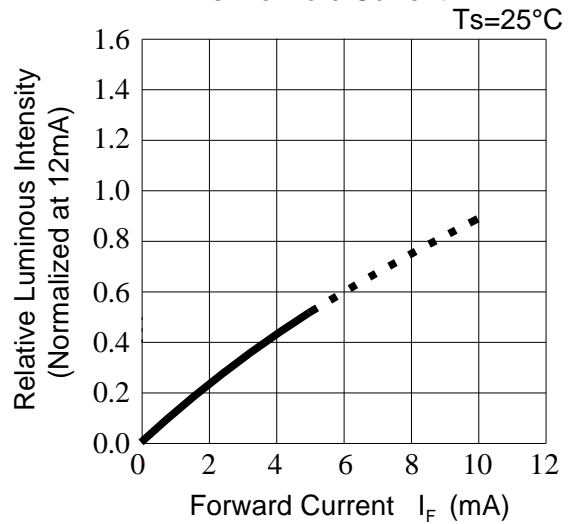

Fig.3-Max.Driving Forward Current vs.Soldering Temperature

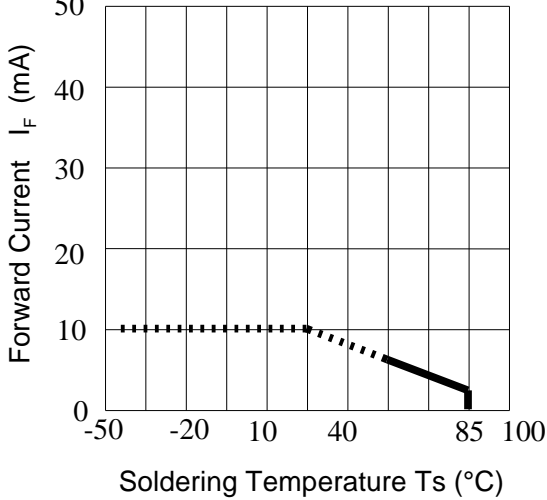
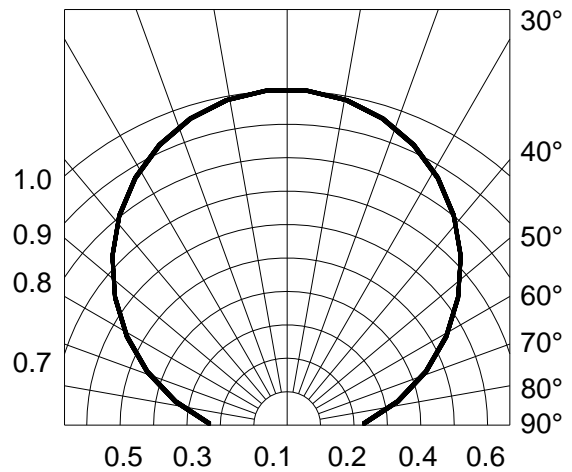

Fig.4-Radiation Diagram $T_a=25^\circ\text{C}$



Electrical Characteristics (Without special instructions ,Ta= -40~+80°C,VDD=9~12V,VSS=0V)

Parameter	Symbol	Min.	Avg.	Max.	Company	Test conditions
Chip internal supply voltage	V _{DD}	3.0	---	5.5	V	---
High level input voltage	V _{IH}	0.7*V _{DD}	---	---	V	Din
Low level input voltage	V _{IL}	---	---	0.3*V _{DD}	V	Din
RGB Maximum Sink current	I _{sink}	----	5	----	mA	V _{DD} =5V

Dynamic Parameter (Ta=25°C):

Parameter	Symbol	Min.	Avg.	Max.	Company	Test conditions
Data transmission speed	F _{DIN}	---	4.5	---	KHz	
DOUT Transmission delay	T _{PLH}	---	80	---	ns	DIN→DOUT
	T _{PHL}	---	80	---	ns	
I out rise time	T _r	---	500	---	ns	V _{OUT} =1V R、G、B=5mA
	T _f	---	500	---	ns	

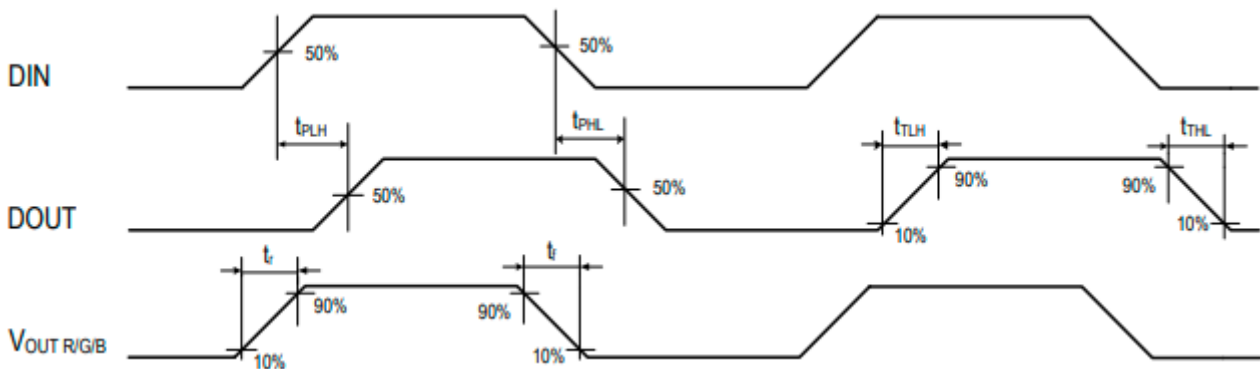

Data Transfer Time (TH+TL=1.25μs±600ns)

T0H	0 code, High time	0.3μs	±0.15μs
T1H	1 code, High time	0.9μs	±0.15μs
T0L	0 code, Low level time	0.9μs	±0.15μs
T1L	1 code, Low level time	0.3μs	±0.15μs
Trst	Reset, Code Low level time	>200μs	

Timing Waveform (Ta=25°C) :

Input code type:

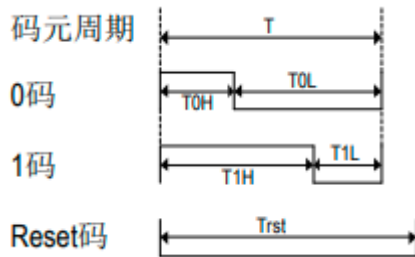

Connection mode:

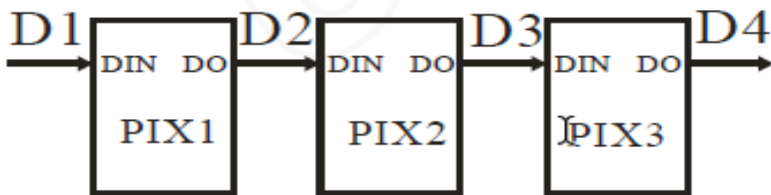

Data Transmission Mode (Ta=25°C):

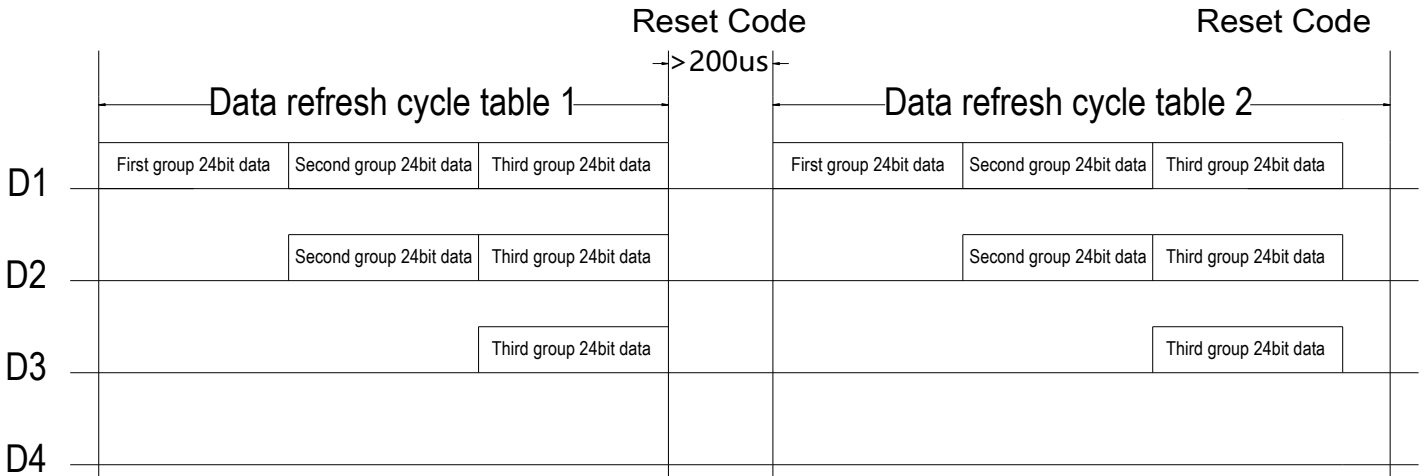

Note:
 Where D1 is the data sent to the MCU side, D2, D3, D4 are automatically shaping and forwarding data for cascaded circuits

24bit Data Structure (Ta=25°C) :



Note:
 High priority, in accordance with the order of RGB to send data (R7 ~ R6 ~ B0)

Typical Application Circuit:

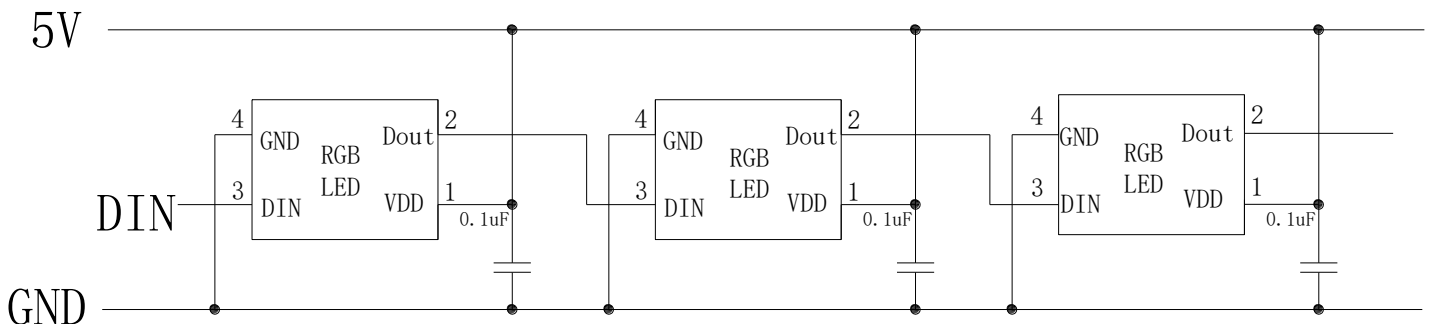

Label Explanation

AMICC

AMICC OPTO-ELECTRONICS
 TECHNOLOGY Co.,LTD



RoHS

P/N: ××××××××

TYPE: ×-××××××××

	CODE	MIN	MAX	UNIT
IV:	XX	XX	XX	mcd
WD:	XX	XX	XX	nm
VF:	XX	XX	XX	V

LOT NO: ××××××××

QTY: ××××



MADE IN CHINA

- CPN: Customer's Product Number
- P/N: Product Number
- TYPE :Part NO.
- LOT NO.: Lot Number
- QTY: Packing Quantity

Reel Dimensions

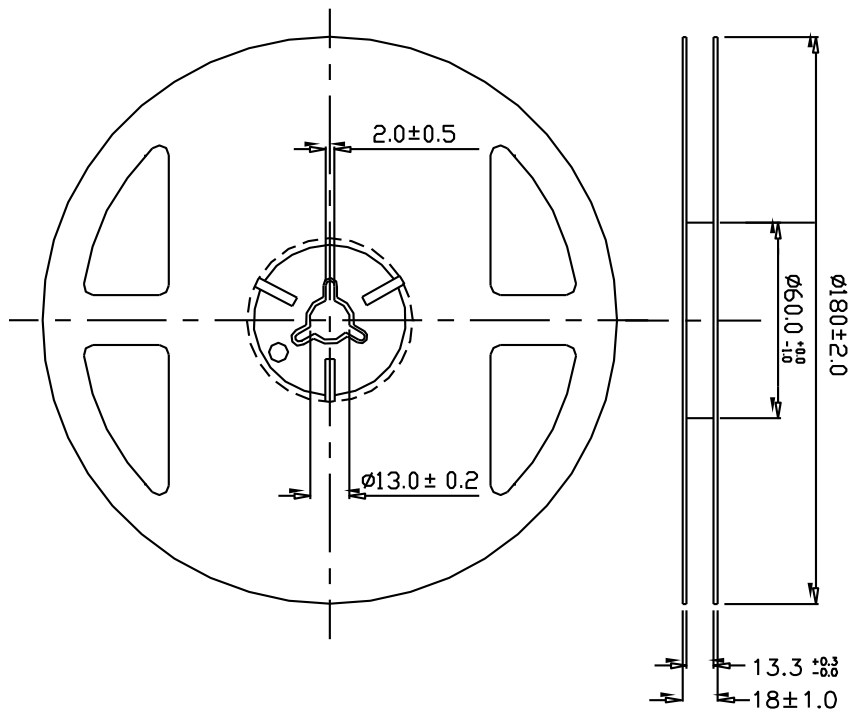

Note:
 Tolerances unless mentioned ± 0.1 mm, Unit = mm

Carrier Tape Dimensions: Loaded Quantity 2000pcs Per Reel

Progressive direction →

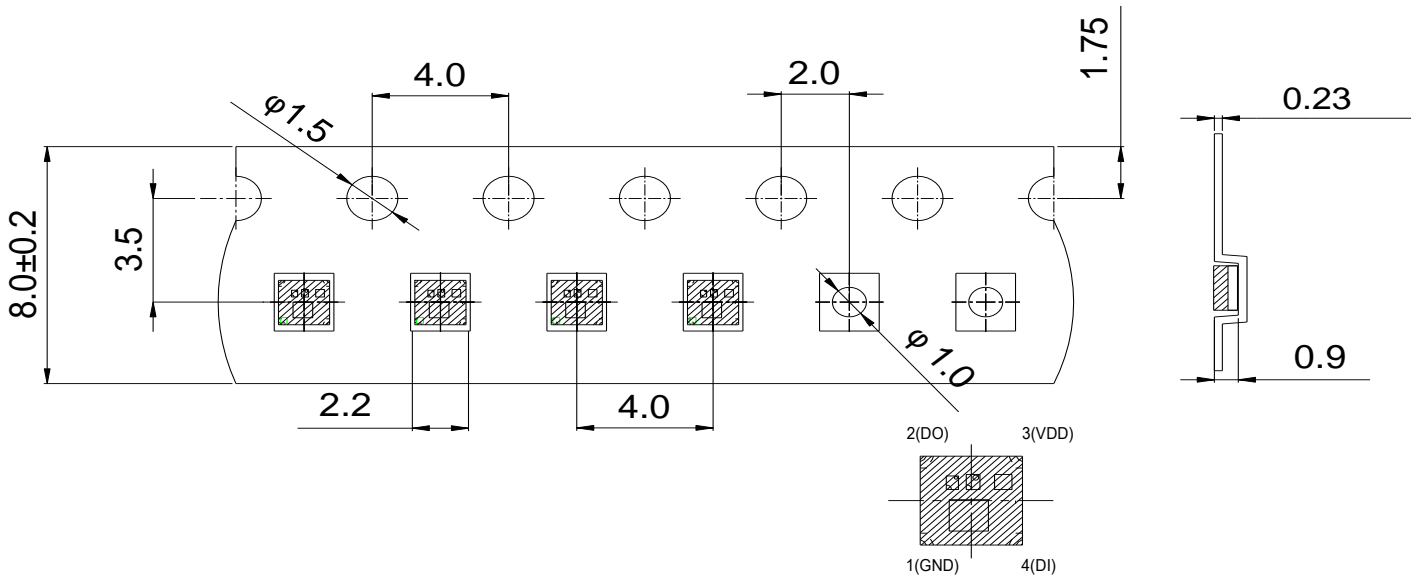

Notes:

1. Tolerance unless mentioned is ± 0.1 mm, Unit = mm.
2. Minimum packing amount is 1000 pcs per reel.

Moisture Resistant Packing Process

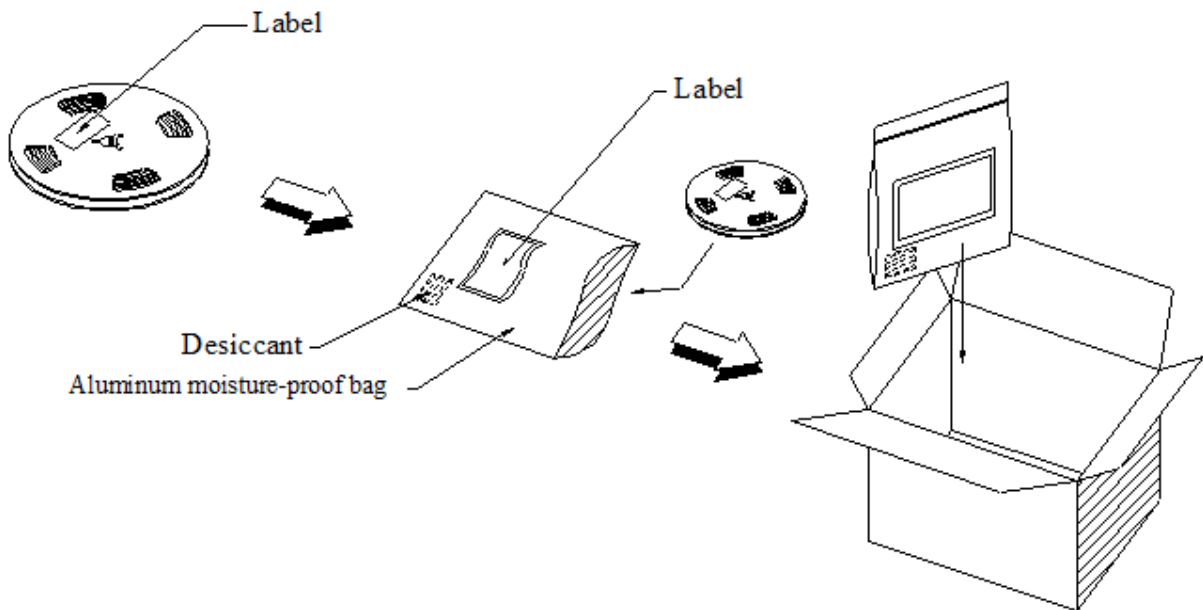

Reliability Test Items and Conditions

The reliability of products shall be satisfied with items listed below.

Confidence level : 90%

LTPD : 10%

No.	Items	Test Condition	Test Hours/Cycles	Sample Size	Ac/Re
1	Reflow Soldering	Temp. : 260°C/10sec.	6 Min.	22 PCS.	0/1
2	Thermal Shock	H : +100°C 5min ∫ 10 sec L : -10°C 5min	300 Cycles	22 PCS.	0/1
3	Temperature Cycle	H : +100°C 15min ∫ 5 min L : -40°C 15min	300 Cycles	22 PCS.	0/1
4	High Temperature/Humidity	Ta=85°C,85%RH	1000 Hrs.	22 PCS.	0/1
5	Low Temperature Storage	Ta=-40°C	1000 Hrs.	22 PCS.	0/1
6	High Temperature Storage	Ta=100°C	1000 Hrs.	22 PCS.	0/1
7	DC Operation Life	Ta=25°C VDD=5V	1000 Hrs.	22 PCS.	0/1

Precautions for Use

1. Dust and cleanliness

- 1.1. To keep the working environment clean. Avoid dust falling onto LED surface. Open the bag on the priority, installed LED components should be stored in a clean container, etc.
- 1.2. Do not use ultrasound to clean LEDs, if the product must use ultrasound, then evaluate some of the parameters affecting the LED

2. Damp-proof packing

LED was packed in aluminum film bags to prevent LED from absorbing moisture during transportation and storage, and desiccant was placed in the bags to absorb moisture.

3. Memory

3.1. In order to avoid LED moisture absorption, LED in bulk or pasted should be stored in a drying box or container with desiccant. Alternatively, it may be stored for a short period of time in the following environments:
temperature: 5°C~30°C Humidity: less than 60%

3.2. When using LED, the aluminum film electrostatic bag should be welded quickly after opening, and the remaining LED should be sealed again. After opening the aluminum film bag, the LED should be reflowed within 1 week.

If you need to bake, please refer to the following baking temperature:

Bake in oven at 70 °C ±5 °C for not less than 24 hours

4. Soldering Condition

4.1 Pb-free solder temperature profile

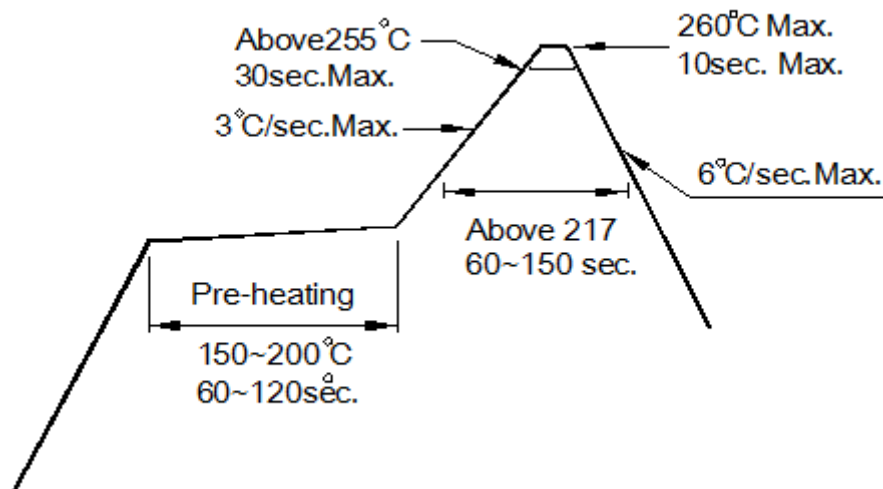

4.2 Reflow soldering should not be done more than two times.

4.3 When soldering, do not put stress on the LEDs during heating.

4.4 After soldering, do not warp the circuit board.

5. Anti-static and surge

5.1. Static electricity and surge can hurt LED.

5.2. In order to protect LED, no matter what time and occasion, as long as access to the LED, have to wear antistatic wrist strap, anti-static foot straps and anti-static gloves.

5.3. All installations and instrumentation shall be grounded.

5.4. In circuit design, the possibility of eliminating the harm of surge to LED should be considered.

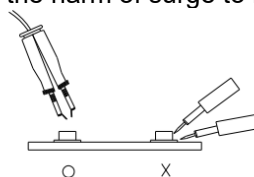

X-ON Electronics

Largest Supplier of Electrical and Electronic Components

Click to view similar products for [Standard LEDs - SMD category](#):

Click to view products by [Amicc manufacturer](#):

Other Similar products are found below :

[LTST-C190KYKT](#) [LTST-C19GD2WT](#) [LTW-170ZDC](#) [LTW-M140SZS40](#) [LTW-M140ZVS](#) [598-8110-100F](#) [598-8610-202F](#) [91-21SUBCS400-A6TR7](#) [QBLP653-IW](#) [QBLP674-IWM-WW](#) [AAAF5060QBFSEEZGS](#) [APT1608QGW](#) [99-213/R6C-AR2T1B/2C](#) [SML-512VWT86A](#) [SML-LX0606SISUGC/A](#) [SML-LXR851SIUPGUBC](#) [LT1ED53A](#) [APFA3010SURKCGKQBDC](#) [APHK1608VGCA](#) [APT2012QGW](#) [LTST-008BGEW](#) [LTW-010DCG](#) [LTW-21TS5](#) [LTW-220DS5](#) [598-8330-117F](#) [65-21SYGC/S530-E3/TR8](#) [CMDA20AYAA7D1S](#) [95-21SURCS530-A3TR10](#) [598-8070-100F](#) [598-8140-100F](#) [598-8610-200F](#) [SML-LXR851SGSIC-TR](#) [SML-512PWT86A](#) [SMF-2432GYC-TR](#) [EASV3015RGYA0](#) [95-21UYC-S530-A5-TR7](#) [LTST-C194TBKT-5A](#) [CLX6E-FKC-CH1M1D1BB7C3D3](#) [SML-LXL0805USBC-TR](#) [SML-LX2835SYSUGCTR](#) [LTW-M670ZVS-M5](#) [APA2106ZGC/G](#) [CLMXB-FKA-CbcfghjnpACBB79463](#) [KPTD-2012LVVBC-D](#) [VFA1101W-5AY3B2-TR](#) [LCB P473-P2R2-3J7L-1-Z](#) [91-21VGC/S556/S68/TR10/S370](#) [LW A67C-S2U1-FK0KM0](#) [LW A673-P1S1-FK0PM0](#) [BL-HE1G033B-TRB](#)