

客户 (Customer) : \_\_\_\_\_

承认书

Approval Sheet

谨致执事者：兹提供敝公司之有关详细规格及图面数据，敬请给予办理试认定手续。  
同时敬请送返一份附有贵公司签认之测试认定后之样品承认书。

We are pleased in sending you herewith on specification and drawings for your approval.  
Please return to us one copy "Approval sheet" with your approved signature.

型号 (Model No.) : A-SL660W1D-C03-4T

发文日期 (Issue Date) : 2021/12/03 承认日期 (Approved Date) : \_\_\_\_\_

Checking signature of Amicc

Designer	Checker	Approver
Allen	Tommy	Solarliu

Approval signature of customer

Designer	Checker	Approver

江苏欧密格光电科技股份有限公司

Jiangsu Amicc Opto-Electronics Technology Co.,Ltd.

地址:江苏省常州市武进区武南中路 98 号

Add: 98.Wu Nan Road, Wujin, Changzhou city, Jiangsu Province

TEL:0086-519-89806999

FAX:0086-519-86523668

EMAIL:AMICC@AMICC.COM

## Mini-Power Type ■ Top View 1016 Package

### A-SL660W1D-C03-4T

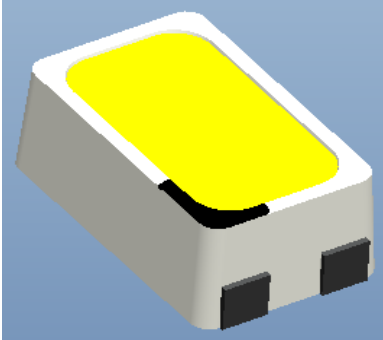

#### ■ Description

The Amicc 660 package has high efficacy, low power consumption, wide viewing angle and a compact form factor. These features make this package to be an ideal LED for all lighting applications.

#### ■ Features

- Top view LED
- High luminous Intensity output
- Wide viewing angle
- Pb-free
- RoHS compliant
- JEDEC MSL 3
- Chip Size 8\*15mil
- Wire material 99.9% Au

#### ■ Applications

- General lighting
- Decorative and Entertainment Lighting
- Indicators
- Automotive Telecommunication
- Switch lights

#### ■ Device Selection Guide

Chip Materials	Emitted Color	Resin Color
InGaN	Nature White	Yellow Diffused

■ Package Dimensions

Top View

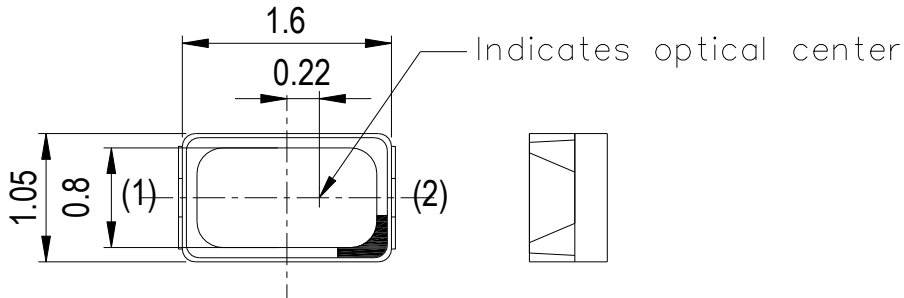

Side View

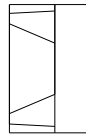

Side View

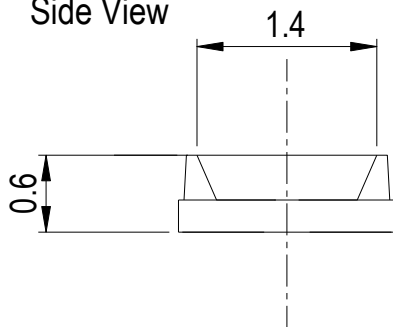

Polarity

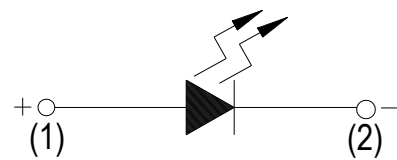

Bottom View

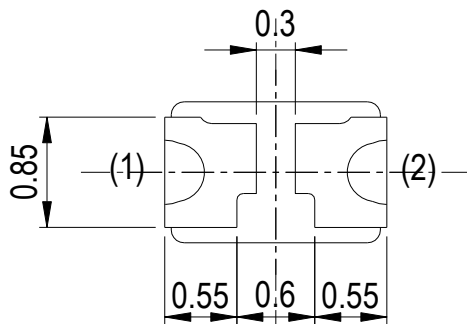

Recommended solder pad

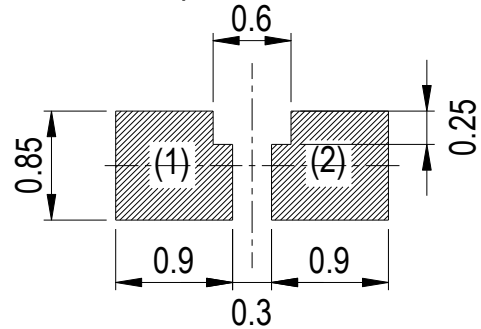

Note:  
 Tolerance without mention is  $\pm 0.1$ mm.

■ **Absolute Maximum Ratings (T<sub>Soldering</sub>=25°C)**

Parameter	Symbol	Rating	Unit
Reverse Voltage	V <sub>R</sub>	5	V
Forward Current	I <sub>F</sub>	35	mA
Peak Forward Current (Duty 1/10 @1ms)	I <sub>FP</sub>	100	mA
Power Dissipation	P <sub>d</sub>	112	mW
Operating Temperature	T <sub>opr</sub>	-40 ~ +85	°C
Storage Temperature	T <sub>stg</sub>	-40 ~ +100	°C
Soldering Temperature	T <sub>sol</sub>	Reflow Soldering : 260 °C for 10 sec. Hand Soldering : 350 °C for 3 sec.	

■ **Electro-Optical Characteristics (T<sub>Soldering</sub>=25°C)**

Parameter	Symbol	Min.	Typ.	Max.	Unit	Condition
Luminous Intensity	I <sub>v</sub>	360	-----	900	mcd	I <sub>F</sub> =5mA
Forward Voltage	V <sub>F</sub>	2.40	-----	3.20	V	I <sub>F</sub> =5mA
Color Rendering Index	CRI	-----	70	----	----	I <sub>F</sub> =5mA
Viewing Angle	2θ <sub>1/2</sub>	-----	120	-----	deg	I <sub>F</sub> =5mA
Reverse Current	I <sub>R</sub>	-----	-----	1	μA	V <sub>R</sub> =7V

Notes:

1. Tolerance of Luminous Intensity: ±10%.
2. Tolerance of Forward Voltage : ±0.1V.

■ **Bin Range of Luminous Intensity**

Bin Code	Min.	Max.	Unit	Condition
AT2	360	450	mcd	I <sub>F</sub> =5mA
AU1	450	565		
AU2	565	715		
AV1	715	900		

Note:  
Tolerance of Luminous Intensity: ±10%.

■ **Bin Range of Forward Voltage**

Bin Code	Min.	Max.	Unit	Condition
32	2.40	2.60	V	I <sub>F</sub> =5mA
34	2.60	2.80		
36	2.80	3.00		
38	3.00	3.20		

Note:  
Tolerance of Forward Voltage: ±0.1V.

■ **Bin Range of Chromaticity Coordinates**

Bin Code	CIE_x	CIE_y	Bin Code	CIE_x	CIE_y
D1	0.249	0.237	E1	0.254	0.247
	0.254	0.247		0.259	0.257
	0.264	0.247		0.269	0.257
	0.259	0.237		0.264	0.247
F1	0.259	0.257	G1	0.264	0.267
	0.264	0.267		0.269	0.277
	0.274	0.267		0.279	0.277
	0.269	0.257		0.274	0.267
H1	0.269	0.277			
	0.274	0.287			
	0.284	0.287			
	0.279	0.277			

Notes:

1. The value is based on driving current by 20mA.
2. Tolerance of Chromaticity Coordinates:  $\pm 0.01$ .

■ **The C.I.E. 1931 Chromaticity Diagram**

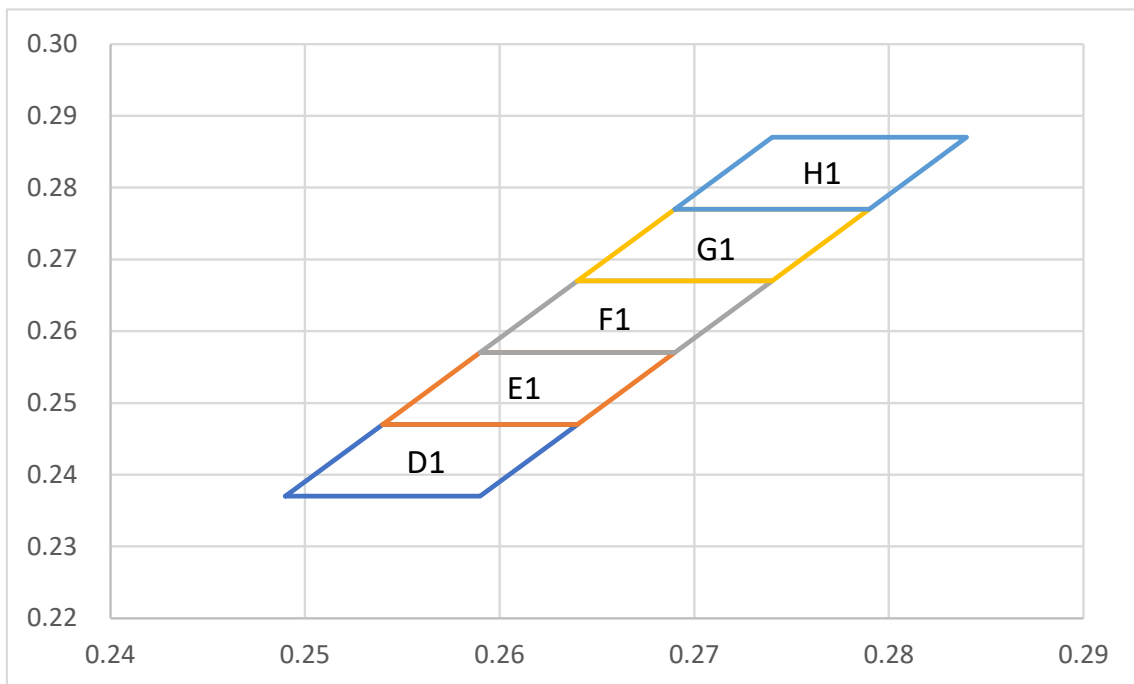

■ **Spectrum Distribution**

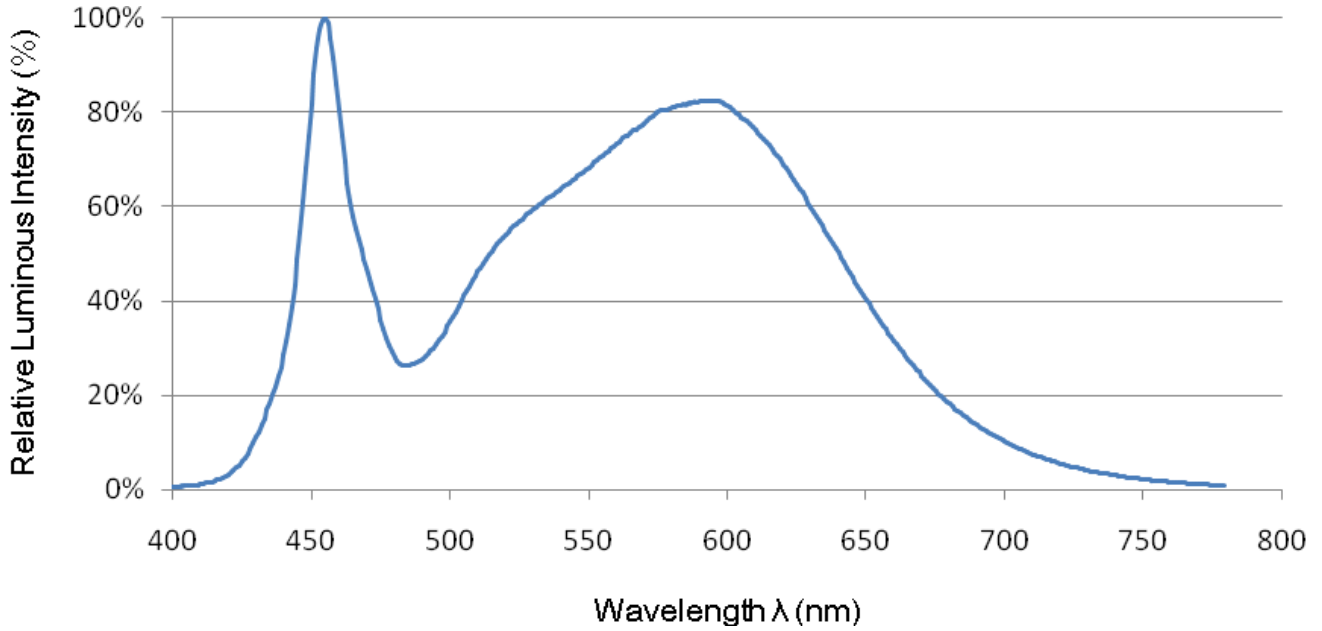

■ **Typical Electro-Optical Characteristics Curves**

Fig.1-Forward Voltage Shift vs. Junction Temperature

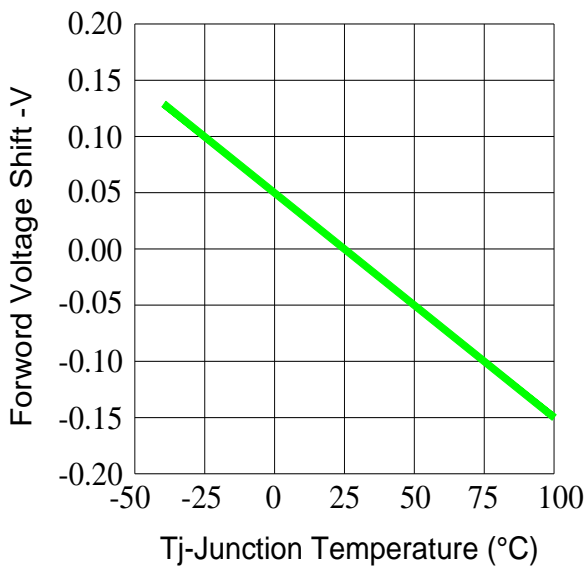
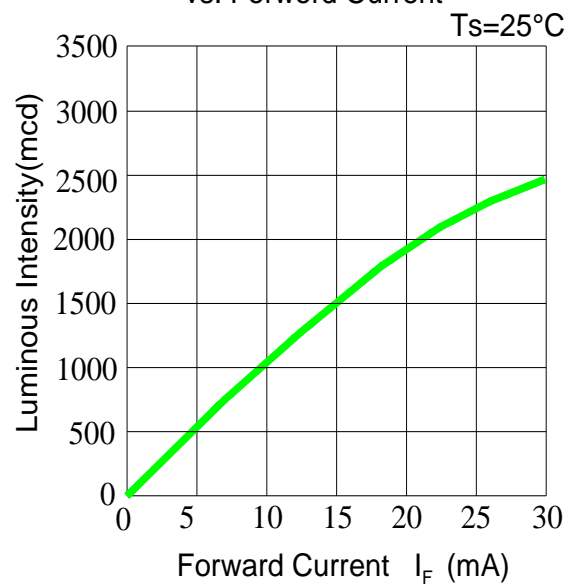

Fig.2- Luminous Flux vs. Forward Current



■ Typical Electro-Optical Characteristics Curves

Fig.3-Relative Luminous Intensity vs.Junction Temperature

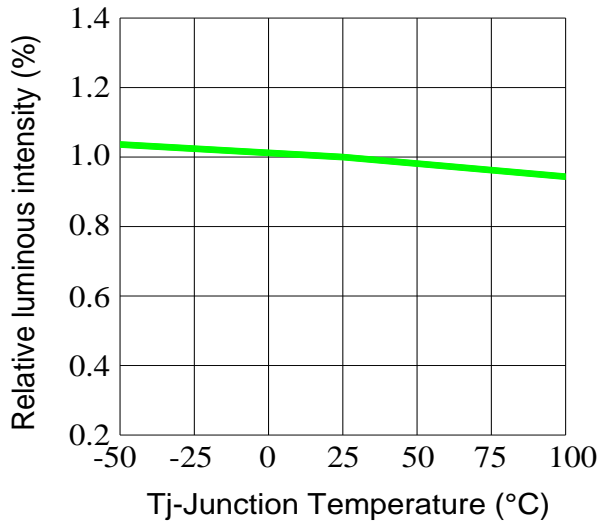

Fig.4-Forward Current vs. Forward Voltage Ta=25°C

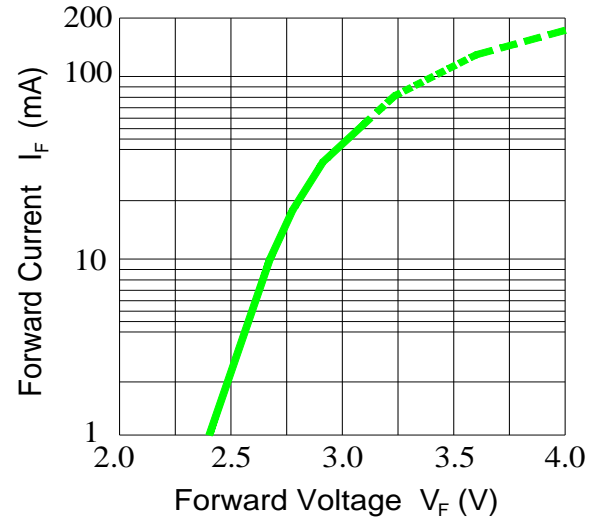

Fig.5-Max.Driving Forward Current vs.Soldering Temperature

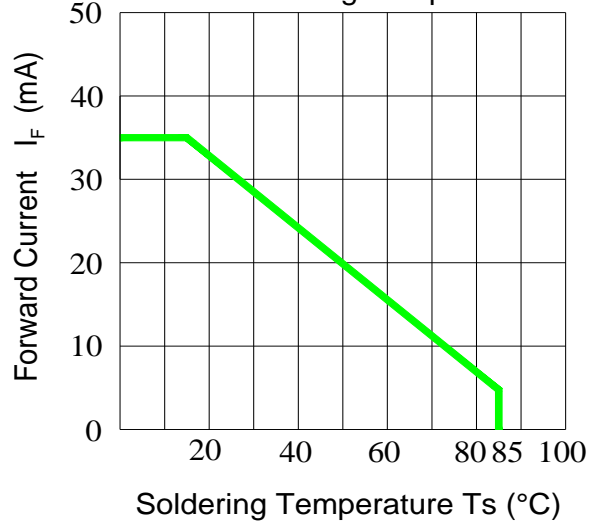
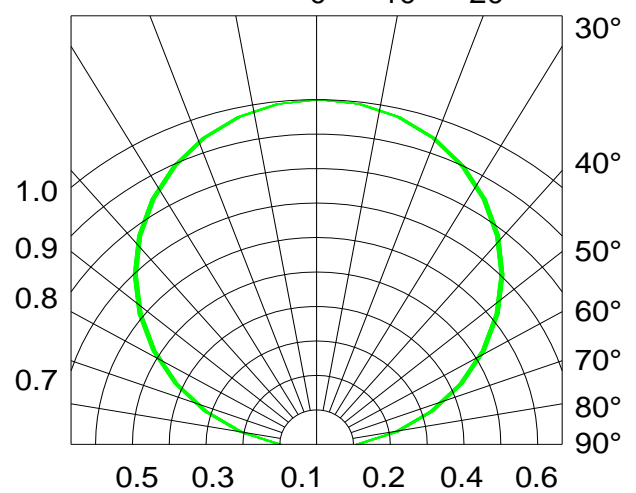

Fig.6-Radiation Diagram Ta=25°C





■ Moisture Resistant Packing Materials

1. Label Explanation

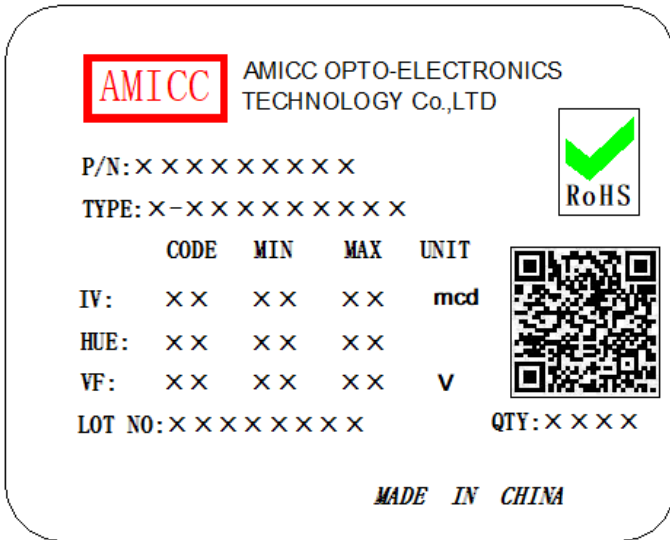

- CPN: Customer's Product Number
- P/N: Product Number
- TYPE: Part NO.
- IV: Luminous Intensity Rank
- HUE: Chromaticity Coordinates Rank
- VF: Forward Voltage Rank
- LOT No: Lot Number
- QTY: Packing Quantity

2. Reel Dimensions

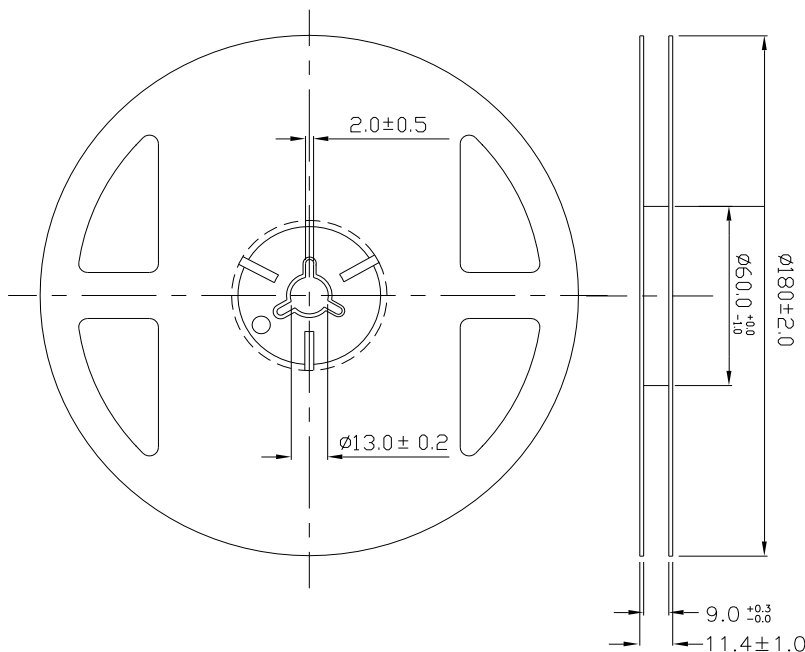

Note:  
 Tolerance without mention is  $\pm 0.1$ mm.

**3. Carrier Tape Dimensions: Loaded Quantity 4000 pcs Per Reel**

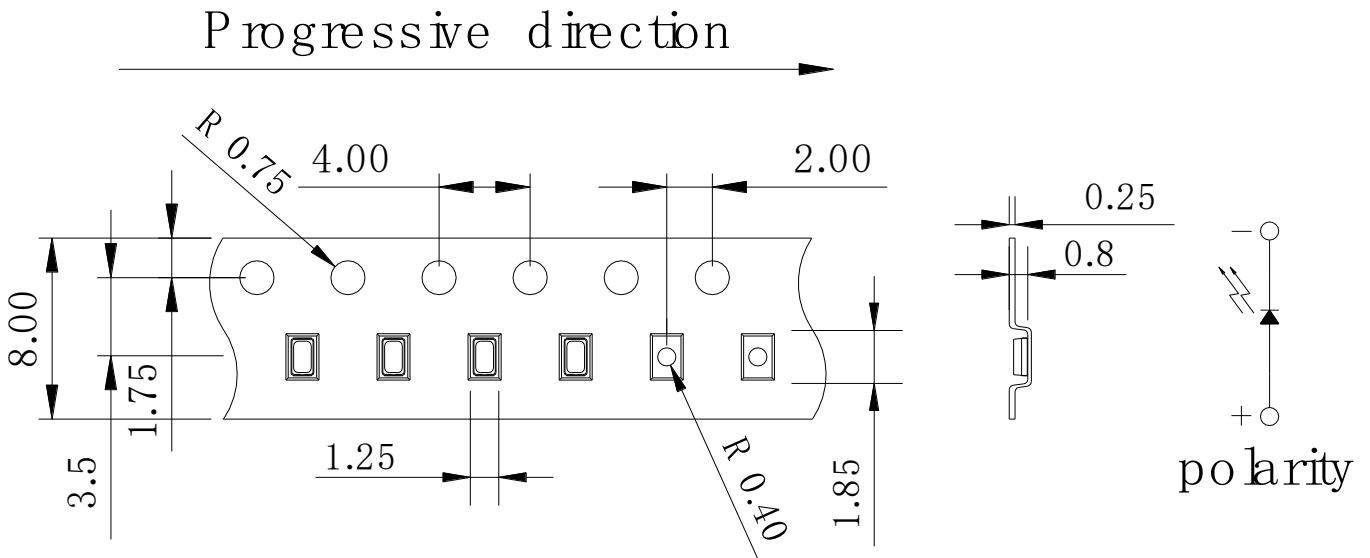

Notes:

1. Tolerance without mention is  $\pm 0.1$ mm.
2. Minimum packing amount is 1000pcs per reel.

**4. Moisture Resistant Packing Process**

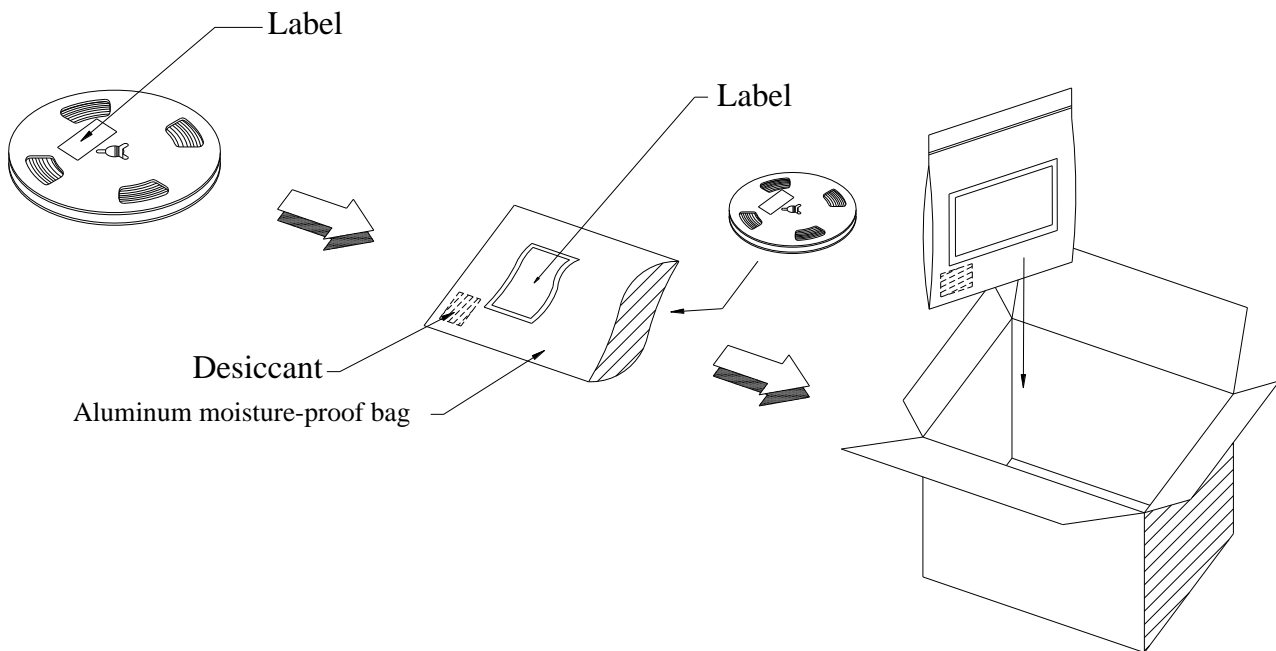

■ **Reliability Test Items and Conditions**

The reliability of products shall be satisfied with items listed below.

Confidence level : 90%

LTPD : 10%

No.	Items	Test Condition	Test Hours/Cycles	Sample Size	Ac/Re
1	Reflow Soldering	Temp. : 260°C/10sec.	6 Min.	22 PCS.	0/1
2	Thermal Shock	H : +100°C 5min ∫ 10 sec L : -10°C 5min	300 Cycles	22 PCS.	0/1
3	Temperature Cycle	H : +100°C 15min ∫ 5 min L : -40°C 15min	300 Cycles	22 PCS.	0/1
4	High Temperature/Humidity	Ta=85°C,85%RH	1000 Hrs.	22 PCS.	0/1
5	Low Temperature Storage	Ta=-40°C	1000 Hrs.	22 PCS.	0/1
6	High Temperature Storage	Ta=100°C	1000 Hrs.	22 PCS.	0/1
7	DC Operation Life	Ts=25°C, I <sub>F</sub> = 20 mA	1000 Hrs.	22 PCS.	0/1

## ■ Precautions for Use

### 1. Over-current-proof

Customer must apply resistors for protection; otherwise slight voltage shift will cause big current change (Burn out will happen).

### 2. Storage

2.1 Do not open moisture proof bag before the products are ready to use.

2.2 Before opening the package: The LEDs should be kept at 30°C or less and 90%RH or less.

2.3 After opening the package: The LED's floor life is 168 Hrs under 30°C or less and 60% RH or less. If unused LEDs remain, it should be stored in moisture proof packages.

2.4 If the moisture absorbent material (silica gel) has faded away or the LEDs have exceeded the storage time, baking treatment should be performed using the following conditions.

Baking treatment: 60±5°C for 24 hours.

### 3. Soldering Condition

#### 3.1 Pb-free solder temperature profile

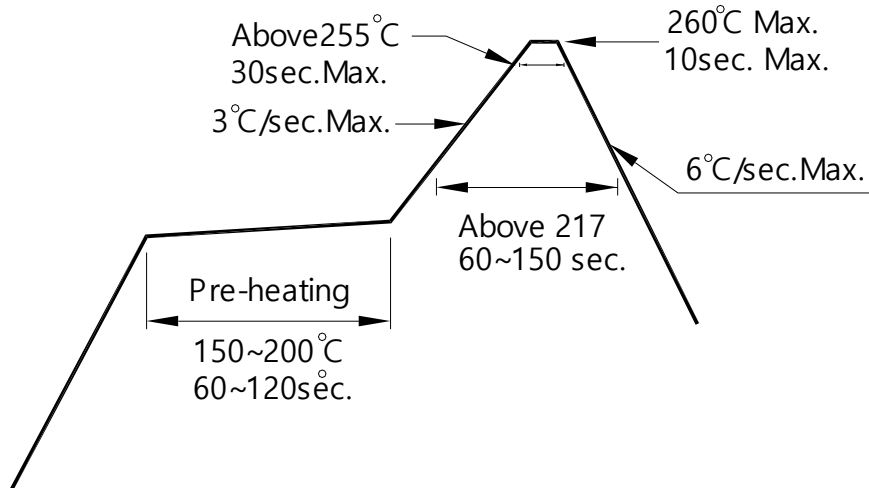

3.2 Reflow soldering should not be done more than two times.

3.3 When soldering, do not put stress on the LEDs during heating.

3.4 After soldering, do not warp the circuit board.

### 4. Soldering Iron

Each terminal is to go to the tip of soldering iron temperature less than 350°C for 3 seconds within once in less than the soldering iron capacity 25W. Leave two seconds and more intervals, and do soldering of each terminal. Be careful because the damage of the product is often started at the time of the hand solder.

### 5. Repairing

Repair should not be done after the LEDs have been soldered. When repairing is unavoidable, a double-head soldering iron should be used (as below figure). It should be confirmed beforehand whether the characteristics of the LEDs will or will not be damaged by repairing.

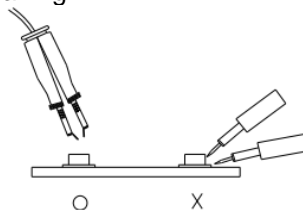

## X-ON Electronics

Largest Supplier of Electrical and Electronic Components

*Click to view similar products for [Amicc manufacturer](#):*

Other Similar products are found below :

[A-SP192GB1D-B01-4T\(HW\)](#) [A-SP1512R6GHC-A01-2A](#) [A-SA3HR334GYRD019](#) [A-SA3HR314GGGGW033-H440](#) [A-SA6S6091RPGCE070-CA](#) [A-SA3HR314GGW026-H22](#) [A-SA3HR324GW014](#) [AM817S\(B\)\(T1\)-FG](#) [A-IRM38G17SC9](#) [A-SA3HR314GD007-H11](#) [A-IA3R326CIR1C-D](#) [A-SA5HR503RG022-H6101](#) [A-SA3R3140RBWE073-CA](#) [A-SP110B1C-C01-2C](#) [A-SA3HR3040SRDN122-H11](#) [A-SA3HR314RGW029-H22](#) [A-SP153IR1C-A02-2D](#) [A-SP192YW1D-D04-4T](#) [A-SI2020R6AGHB1C-C01-2T](#) [AM816S\(B\)\(T1\)-CG](#) [A-SP192CW1D-C06-4T](#) [A-SC6303AR6AGHY3AC-A01-2T](#) [A-SP194R6C-C01-3T](#) [A-SP1103R6AGHB1W-C01-2C](#) [A-SC880IR3C-P03-1T](#) [A-SC667R6AGHB1W-A01-1T](#) [A-SP110W1D-C03-2C](#) [A-SP1502R6W1D-A01-2T](#) [A-SP110R6C-C01-2C](#) [A-SC6302B1R6C-A02-2T](#) [A-SP150B1C-A01-3T](#) [A-SP153IR1C-A02-2T](#) [A-SP1103R6GHB1W-C01-2C](#) [A-SA3R302BWCE062-30](#) [A-SA3R3040BWCE061](#) [A-SL660B1C-C01-4T](#) [A-SP170B1C-C02-3T](#) [A-SP150Y3AC-A01-3T](#) [A-SP192GS1D-C01-4T](#) [A-SP1102DR6W1D-C01-2C](#) [A-SP1923XR6GHB1C-A01-3T](#) [A-SP110GHC-C01-2C](#) [A-SP110W1D-C01-2C](#) [A-SC6303R6AGHB1C-A01-2T](#) [A-SP1942R5G2C-C01-2T](#) [A-SP158IR1C-A02-2D](#) [A-SP192YR6C-A01-4T](#) [A-SC6302R6AGHC-A03-2T](#) [A-SP150R6AC-A01-3T](#) [A-SP194ZW1D-C07-4T](#)