

客户 (Customer) : _____

承认书

Approval Sheet

谨致执事者：兹提供敝公司之有关详细规格及图面数据, 敬请给予办理试认定手续。
同时敬请送返一份附有贵公司签认之测试认定后之样品承认书。

We are pleased in sending you herewith on specification and drawings for your approval.
Please return to us one copy "Approval sheet" with your approved signature.

型号 (Model No.) : A-SP1103R6GHB1C-A01-2C

发文日期 (Issue Date) : 2019/01/23 承认日期 (Approved Date) : _____

Checking signature of Amicc

Designer	Checker	Approver
Allen	<i>Tommy</i>	Solarliu

Approval signature of customer

Designer	Checker	Approver

江苏欧密格光电科技股份有限公司
Jiangsu Amicc Opto-Electronics Technology Co.,Ltd.
地址: 江苏省常州市武进区武南中路 98 号
Add: 98.Wu Nan Road, Wujin, Changzhou city, Jiangsu Province
TEL:0086-519-89806966
FAX:0086-519-86523668
EMAIL:amicc@amicc.com

Multi-Color Type ■ Side view 1204 Package A-SP1103R6GHB1C-A01-2C



Features

- 1204 package
- Side view LED
- Compatible with infrared and vapor phase reflow solder process.
- Wide viewing angle
- Pb-free
- RoHS compliant
- JEDEC MSL 2

Description

The Amicc 1204 package has high efficacy, high power consumption, wide viewing angle and a compact form factor. These features make this package an ideal LED for all lighting applications.

Applications

- General lighting
- Decorative and Entertainment Lighting
- Indicators
- Automotive Telecommunication
- Switch lights

Device Selection Guide

Type	Chip Materials	Emitted Color	Resin Color
R6	AlGaInP	Brilliant Red	Water Clear
GH	InGaN	Green	
B1	InGaN	Blue	

Absolute Maximum Ratings (T_{Soldering}=25°C)

Parameter	Symbol	Rating	Unit
Forward Current	I _F	25	mA
Peak Forward Current (Duty 1/10 @1ms)	I _{FP}	R6:60	mA
		GH:60	
		B1:60	
Power Dissipation	P _d	R6:60	mW
		GH:90	
		B1:90	
Operating Temperature	T _{opr}	-40 ~ +85	°C
Storage Temperature	T _{stg}	-40 ~ +100	°C
Junction Temperature	T _j	115	°C
Soldering Temperature	T _{sol}	Reflow Soldering : 260 °C for 10 sec.	
		Hand Soldering : 350 °C for 3 sec.	

Note:

The products are sensitive to static electricity and must be carefully taken when handling products.

Electro-Optical Characteristics (T_{Soldering}=25°C)

Parameter	Symbol	Color	Min.	Typ.	Max.	Unit	Condition
Luminous Intensity	I _v	R6	140	-----	285	mcd	I _F =20mA
		GH	565	-----	1120		
		B1	140	-----	285		
Peak Wavelength	λ _p	R6	-----	632	-----	nm	I _F =20mA
		GH	-----	518	-----		
		B1	-----	468	-----		
Dominant Wavelength	λ _d	R6	-----	624	-----	nm	I _F =20mA
		GH	515	-----	535		
		B1	460	-----	475		
Forward Voltage	V _F	R6	1.7	-----	2.4	V	I _F =20mA
		GH	2.7	-----	3.6		
		B1	2.7	-----	3.6		
Viewing Angle	2θ _{1/2}		-----	120	-----	deg	I _F =20mA
Reverse Current	I _R	R6	-----	-----	10	μA	V _R =5V
		GH	-----	-----	10		
		B1	-----	-----	10		

Notes:

1. Tolerance of Luminous Intensity ±10%.
2. Tolerance of Dominant Wavelength ±1nm.
3. Tolerance of Forward Voltage ±0.1V.

Bin Code Description

R6:

Bin Code	Min.	Max.	Unit	Condition
AR2	140	180	mcd	I _F =20mA
AS1	180	225		
AS2	225	285		

GH:

Bin Code	Min.	Max.	Unit	Condition
AU2	565	715	mcd	I _F =20mA
AV1	715	900		
AV2	900	1120		

B1:

Bin Code	Min.	Max.	Unit	Condition
AR2	140	180	mcd	I _F =20mA
AS1	180	225		
AS2	225	285		

Note:
 Tolerance of Luminous Intensity: ±10%.

Bin Range of Dominant Wavelength

G1:

Bin Code	Min.	Max.	Unit	Condition
U	515	520	nm	I _F =20mA
V	520	525		
X	525	530		
Y	530	535		

B1:

Bin Code	Min.	Max.	Unit	Condition
T	460	465	nm	I _F =20mA
X	465	470		
Y	470	475		

Note:
 Tolerance of Dominant Wavelength: ±1nm

Spectrum Distribution

R6:

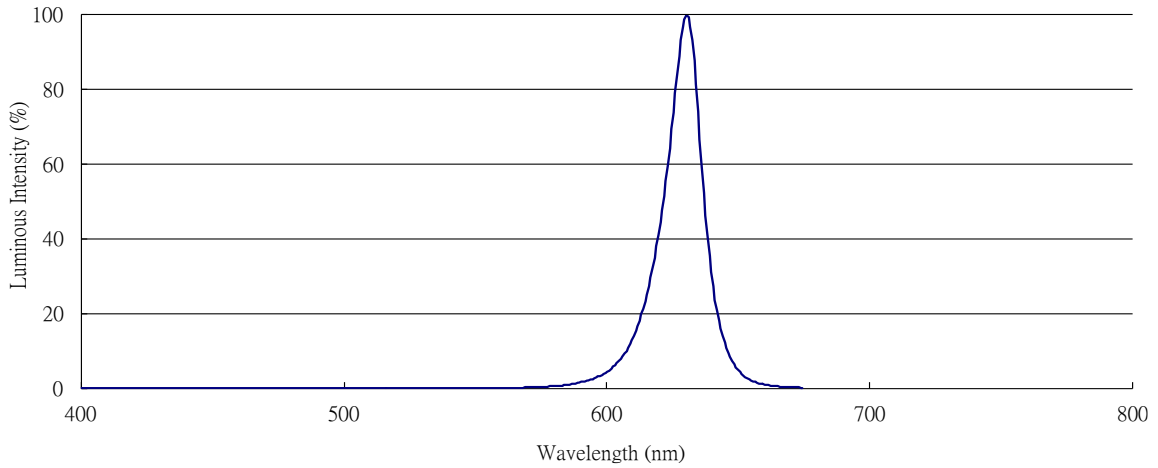

GH:

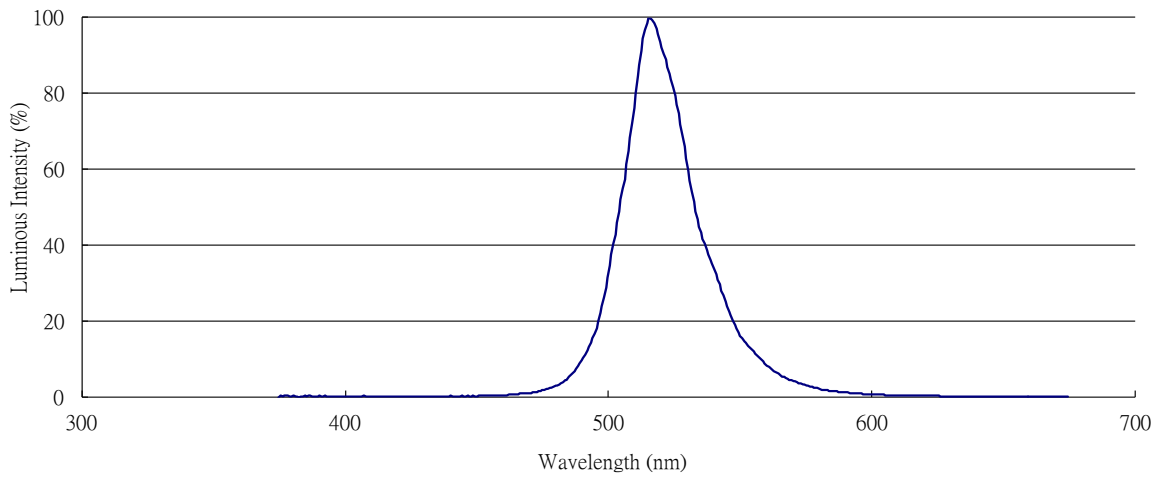

B1:

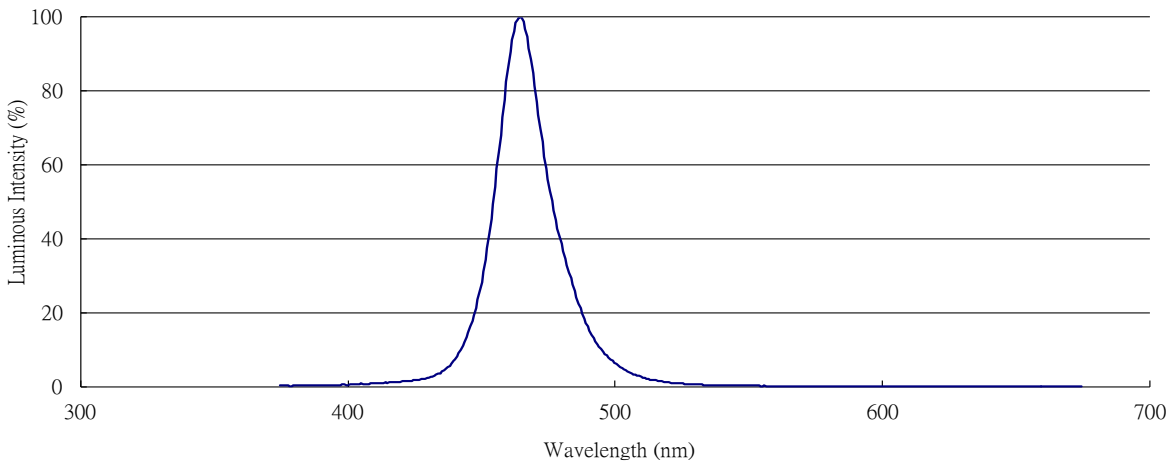

Typical Electro-Optical Characteristics Curve(Chip code: R6)

Fig.1-Forward Voltage Shift vs. Junction Temperature

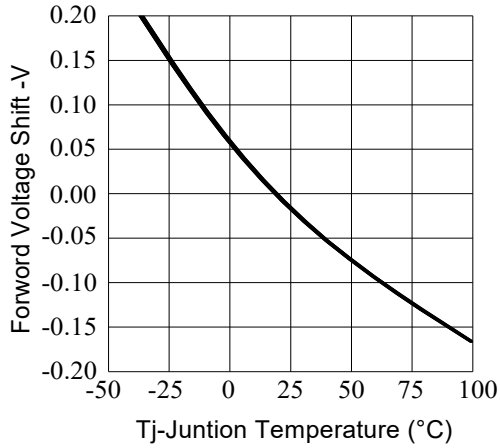

Fig.2-Relative Luminous Intensity vs. Forward Current

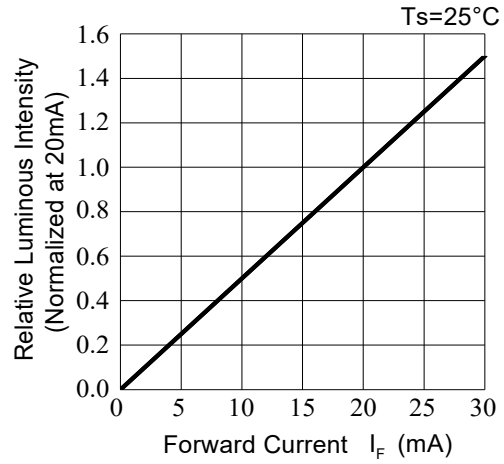

Fig.3-Relative Luminous Intensity vs. Junction Temperature

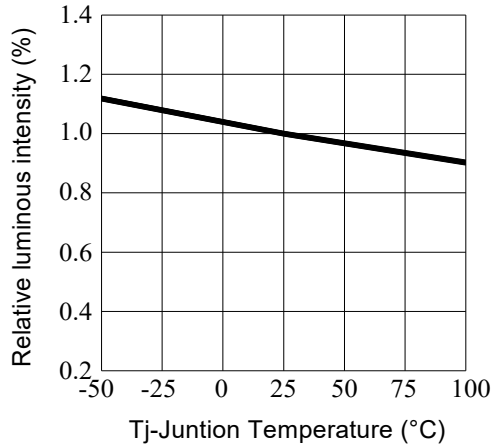

Fig.4-Forward Current vs. Forward Voltage

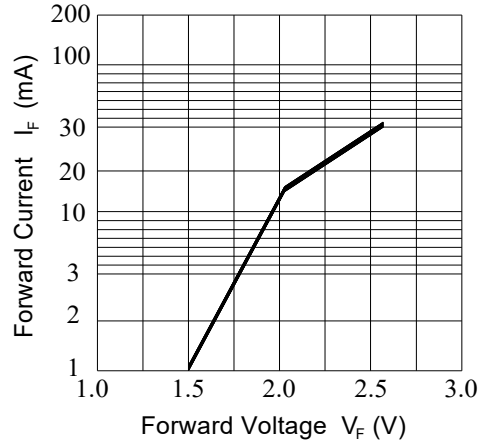

Fig.5-Max. Driving Forward Current vs. Soldering Temperature

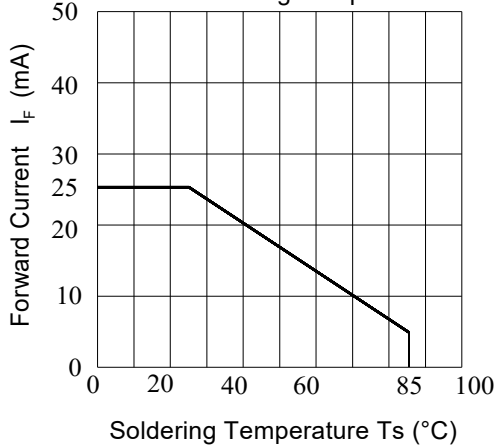
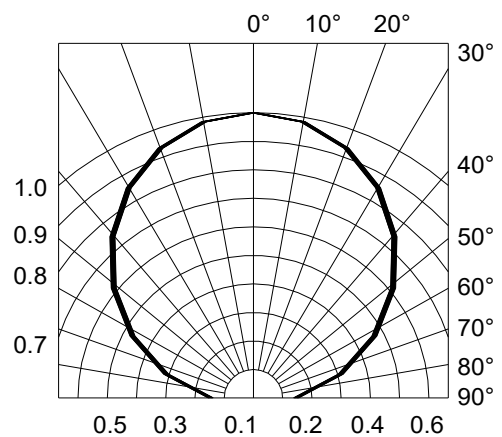

Fig.6-Radiation Diagram



Typical Electro-Optical Characteristics Curve (Chip code: GH/B1)

Fig.1-Forward Voltage Shift vs. Junction Temperature

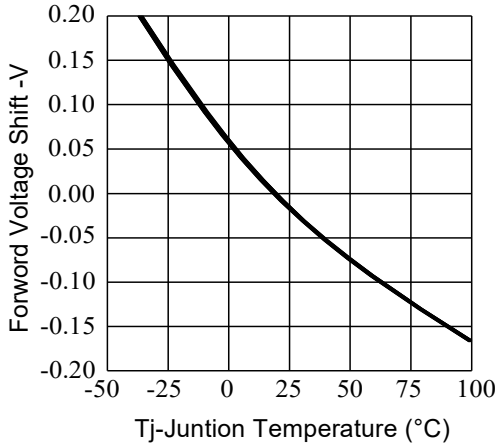

Fig.2-Relative Luminous Intensity vs. Forward Current

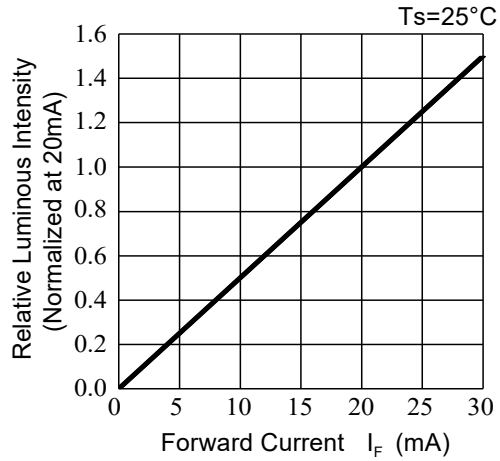

Fig.3-Relative Luminous Intensity vs. Junction Temperature

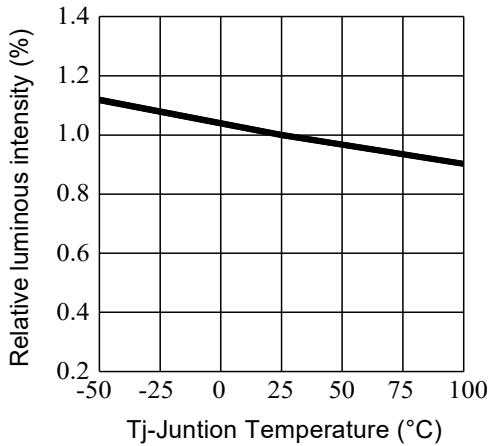

Fig.4-Forward Current vs. Forward Voltage

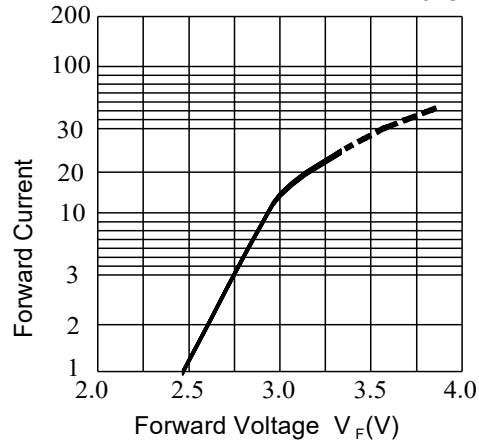

Fig.5-Max. Driving Forward Current vs. Soldering Temperature

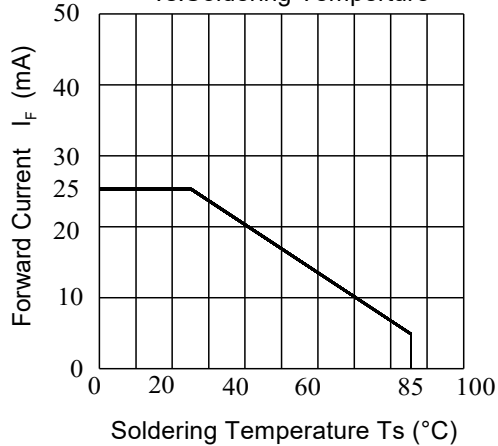
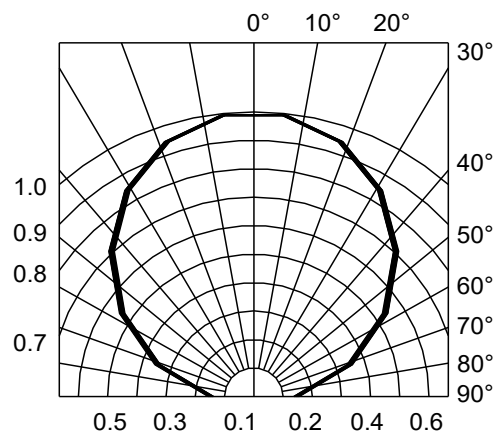
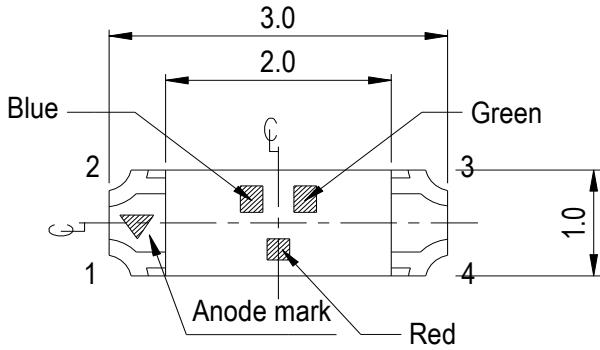

Fig.6-Radiation Diagram



Package Dimension



Polarity

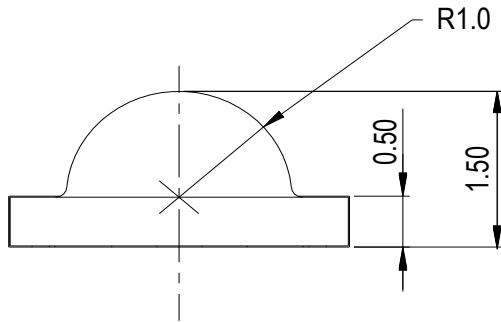
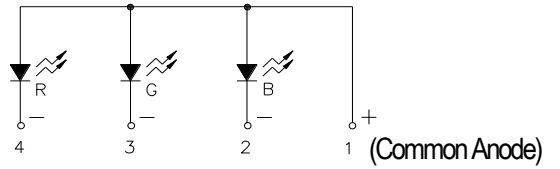

Recommended Solder Pad

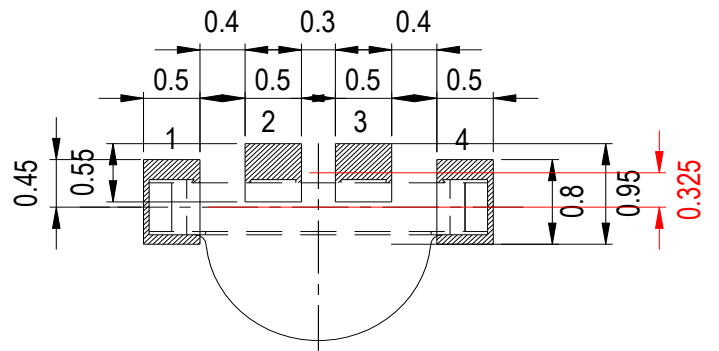
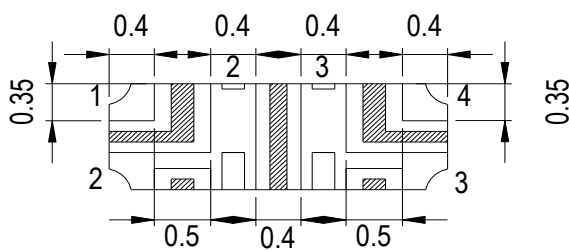

Note:
 Tolerance unless mentioned is ± 0.1 mm, Unit = mm.

Moisture Resistant Packing Materials

Label Explanation

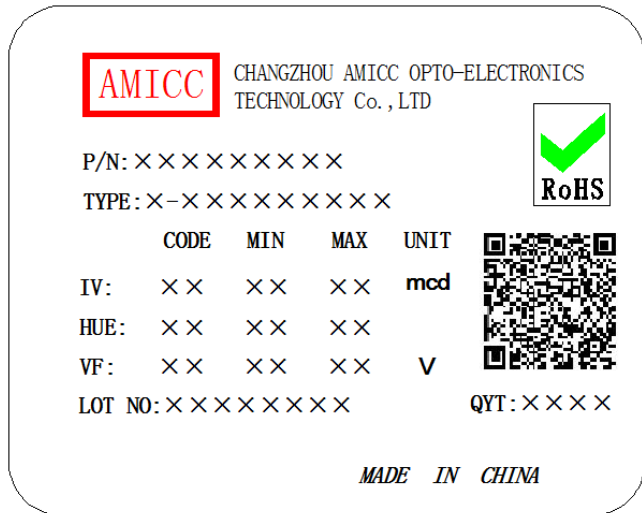

- CPN: Customer's Product Number
- P/N: Product Number
- QTY: Packing Quantity
- CAT: Luminous Intensity Rank
- HUE: Dom. Wavelength Rank
- REF: Forward Voltage Rank
- LOT No: Lot Number

Reel Dimensions

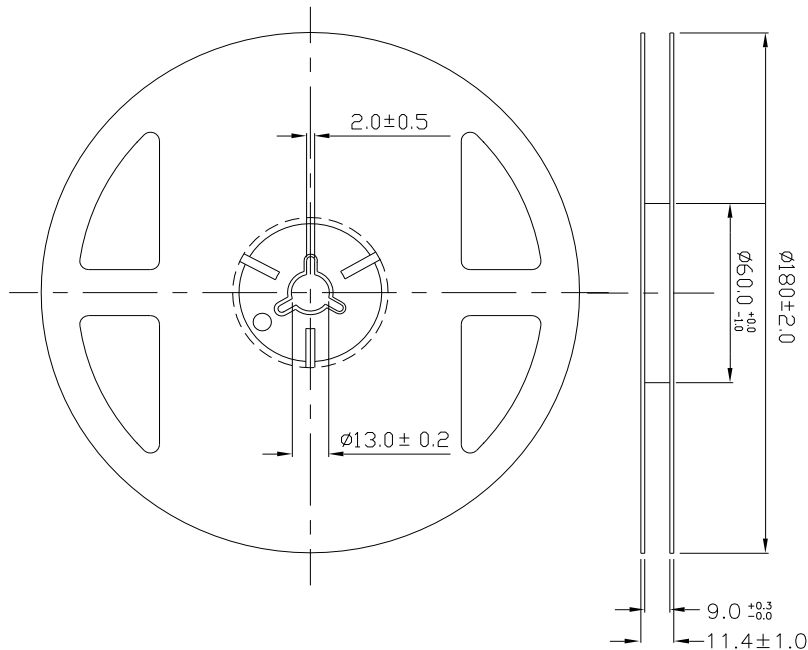

Note:
 Tolerances unless mentioned ±0.1mm, Unit = mm.

Carrier Tape Dimensions: Loaded Quantity 2000 pcs Per Reel

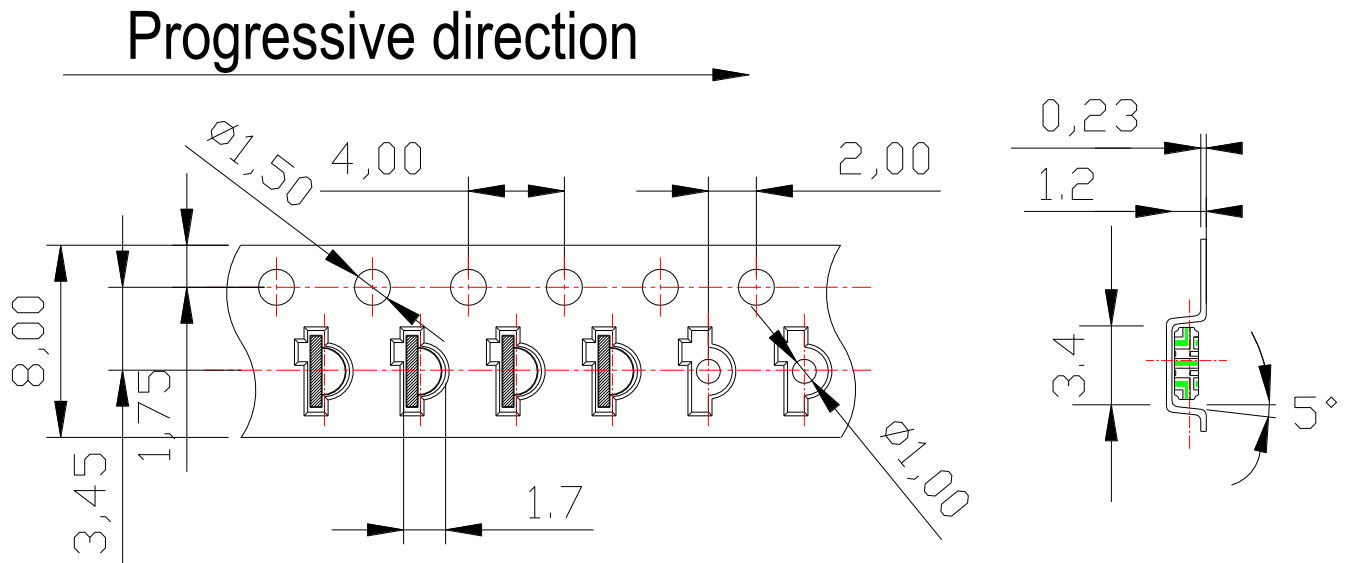

- Notes:
1. Tolerance unless mentioned is ± 0.1 mm, Unit = mm.
 2. Minimum packing amount is 1000/2000 pcs per reel.

Moisture Resistant Packing Process

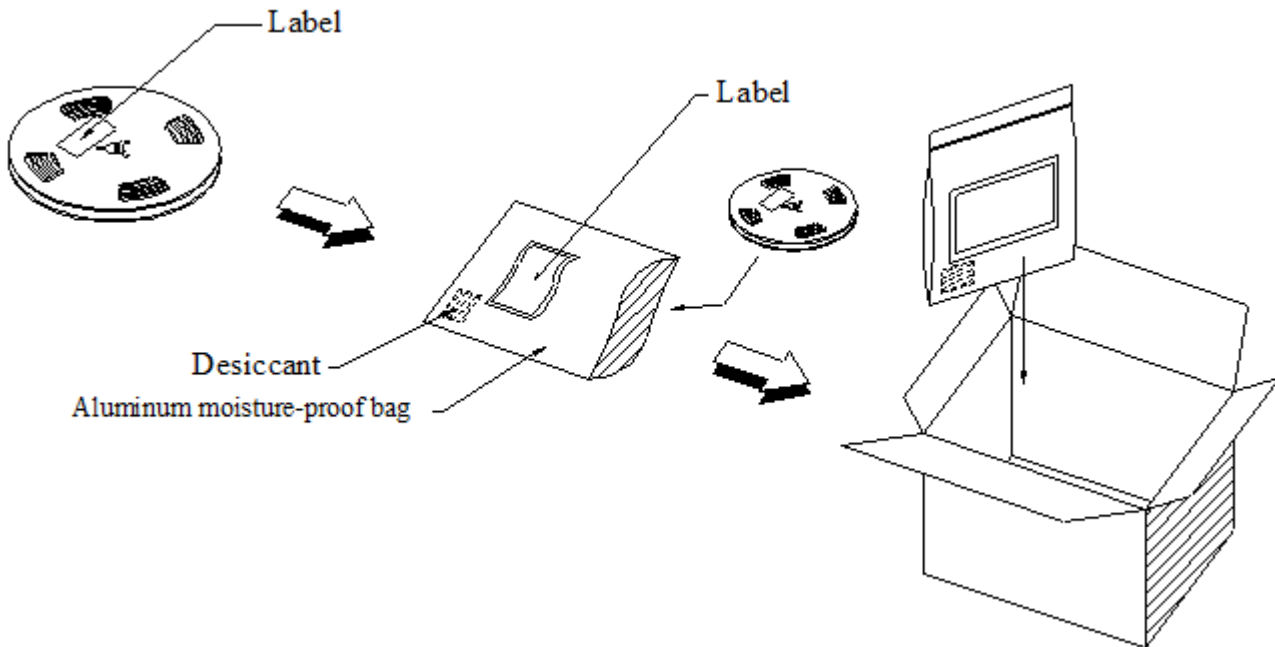

Moisture/Reflow sensitivity classification

IPC / JEDEC J-STD-020C: Level 2

Reliability Test Items and Conditions

The reliability of products shall be satisfied with items listed below.

Confidence level : 90%

LTPD : 10%

No.	Items	Test Condition	Test Hours/Cycles	Sample Size	Ac/Re
1	Reflow Soldering	Temp. : 260°C/10sec.	6 Min.	22 PCS.	0/1
2	Thermal Shock	H : +100°C 5min ∫ 10 sec L : -10°C 5min	300 Cycles	22 PCS.	0/1
3	Temperature Cycle	H : +100°C 15min ∫ 5 min L : -40°C 15min	300 Cycles	22 PCS.	0/1
4	High Temperature/Humidity	Ta=85°C,85%RH	1000 Hrs.	22 PCS.	0/1
5	Low Temperature Storage	Ta=-40°C	1000 Hrs.	22 PCS.	0/1
6	High Temperature Storage	Ta=100°C	1000 Hrs.	22 PCS.	0/1
7	DC Operation Life	Ta=25°C, I _F = 20 mA	1000 Hrs.	22 PCS.	0/1

Precautions for Use

1. Over-current-proof

Customer must apply resistors for protection; otherwise slight voltage shift will cause big current change (Burn out will happen).

2. Storage

2.1 Do not open moisture proof bag before the products are ready to use.

2.2 Before opening the package: The LEDs should be kept at 30°C or less and 90%RH or less.

2.3 After opening the package: The LED's floor life is 1 year under 30°C or less and 60% RH or less. If unused LEDs remain, it should be stored in moisture proof packages.

2.4 If the moisture absorbent material (silica gel) has faded away or the LEDs have exceeded the storage time, baking treatment should be performed using the following conditions.

Baking treatment: 60±5°C for 24 hours.

3. Soldering Condition

3.1 Pb-free solder temperature profile

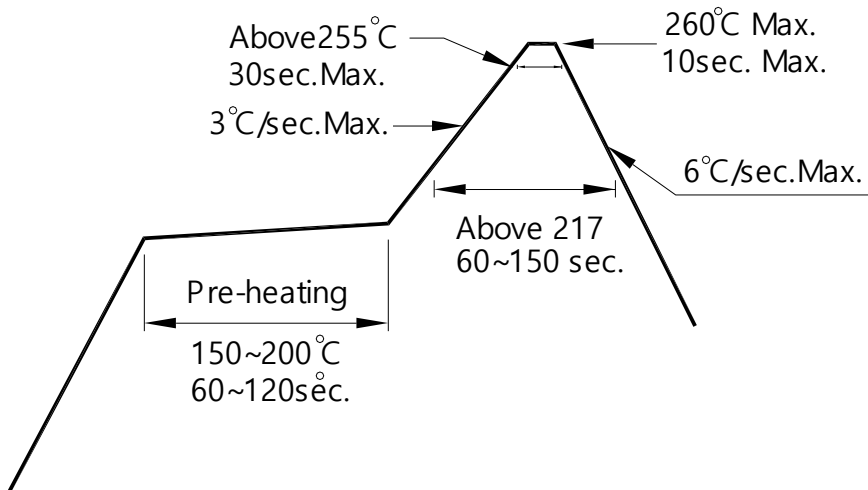

3.2 Reflow soldering should not be done more than two times.

3.3 When soldering, do not put stress on the LEDs during heating.

3.4 After soldering, do not warp the circuit board.

4. Soldering Iron

Each terminal is to go to the tip of soldering iron temperature less than 350°C for 3 seconds within once in less than the soldering iron capacity 25W. Leave two seconds and more intervals, and do soldering of each terminal. Be careful because the damage of the product is often started at the time of the hand solder.

5. Repairing

Repair should not be done after the LEDs have been soldered. When repairing is unavoidable, a double-head soldering iron should be used (as below figure). It should be confirmed beforehand whether the characteristics of the LEDs will or will not be damaged by repairing.

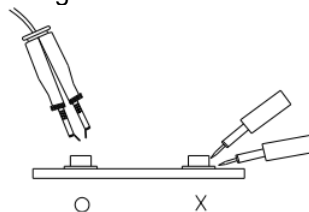

X-ON Electronics

Largest Supplier of Electrical and Electronic Components

Click to view similar products for [Standard LEDs - SMD category](#):

Click to view products by [Amicc manufacturer](#):

Other Similar products are found below :

[LTST-C190KYKT](#) [LTST-C19GD2WT](#) [LTW-170ZDC](#) [LTW-M140SZS40](#) [LTW-M140ZVS](#) [598-8110-100F](#) [598-8610-202F](#) [91-21SUBCS400-A6TR7](#) [QBLP653-IW](#) [QBLP674-IWM-WW](#) [AAAF5060QBFSEEZGS](#) [APT1608QGW](#) [99-213/R6C-AR2T1B/2C](#) [SML-512VWT86A](#) [SML-LX0606SISUGC/A](#) [SML-LXR851SIUPGUBC](#) [LT1ED53A](#) [APFA3010SURKCGKQBDC](#) [APHK1608VGCA](#) [APT2012QGW](#) [LTST-008BGEW](#) [LTW-010DCG](#) [LTW-21TS5](#) [LTW-220DS5](#) [598-8330-117F](#) [65-21SYGC/S530-E3/TR8](#) [CMDA20AYAA7D1S](#) [95-21SURCS530-A3TR10](#) [598-8070-100F](#) [598-8140-100F](#) [598-8610-200F](#) [SML-LXR851SGSIC-TR](#) [SML-512PWT86A](#) [SMF-2432GYC-TR](#) [EASV3015RGYA0](#) [95-21UYC-S530-A5-TR7](#) [LTST-C194TBKT-5A](#) [CLX6E-FKC-CH1M1D1BB7C3D3](#) [SML-LXL0805USBC-TR](#) [SML-LX2835SYSUGCTR](#) [LTW-M670ZVS-M5](#) [APA2106ZGC/G](#) [CLMXB-FKA-CbcfghjnpACBB79463](#) [KPTD-2012LVVBC-D](#) [VFA1101W-5AY3B2-TR](#) [LCB P473-P2R2-3J7L-1-Z](#) [91-21VGC/S556/S68/TR10/S370](#) [LW A67C-S2U1-FK0KM0](#) [LW A673-P1S1-FK0PM0](#) [BL-HE1G033B-TRB](#)