

客户 (Customer) : _____

承认书

Approval Sheet

谨致执事者：兹提供敝公司之有关详细规格及图面数据,敬请给予办理试认定手续.

同时敬请送返一份附有贵公司签认之测试认定后之样品承认书.

We are pleased in sending you herewith on specification and drawings for your approval.
Please return to us one copy "Approval sheet" with your approved signature.

型号 (Model No.) : A-SP1922BR6W1D-C01-3D

发文日期 (Issue Date) : 2022/06/13 承认日期 (Approved Date) : _____

Checking signature of Amicc

| Designer | Checker | Approver |
|----------|---------|----------|
| | | |

Approval signature of customer

| Designer | Checker | Approver |
|----------|---------|----------|
| | | |

江苏欧密格光电科技股份有限公司

Jiangsu Amicc Opto-Electronics Technology Co.,Ltd

地址: 江苏省常州市武进区武南中路 98 号

Add: 98.Wu Nan Road, Wujin, Changzhou city, Jiangsu Province

TEL:0086-519-89806966

FAX:0086-519-86523668

EMAIL:amicc@amicc.com

Multi-Color Type ■ Side view Package

A-SP1922BR6W1D-C01-3D

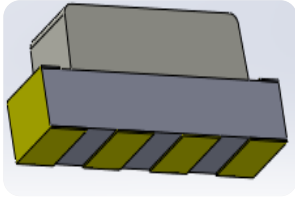

Features

- Side view package
- Side view LED
- Compatible with infrared and vapor phase reflow solder process.
- Wide viewing angle
- Pb-free
- RoHS compliant

Description

The Amicc 1922B package has high efficacy, high power consumption, wide viewing angle and a compact form factor. These features make this package an ideal LED for all lighting applications.

Applications

- General lighting
- Decorative and Entertainment Lighting
- Indicators
- Automotive Telecommunication
- Switch lights

Device Selection Guide

| Type | Chip Materials | Emitted Color | Resin Color |
|------|----------------|---------------|-----------------|
| R6 | AlGaInP | Red | Yellow Diffused |
| W1 | InGaN | White | |

Absolute Maximum Ratings (T_{Soldering}=25°C)

| Parameter | Symbol | Color | Rating | Unit |
|--|------------------|-------|---|------|
| Forward Current | I _F | R6/W1 | 25/10 | mA |
| Peak Forward Current (Duty 1/10 @1ms) | I _{FP} | R6 | 60 | mA |
| | | W1 | 100 | |
| Power Dissipation | P _d | R6 | 60 | mW |
| | | W1 | 40 | |
| Operating Temperature | T _{opr} | | -40~+85 | °C |
| Storage Temperature | T _{stg} | | -40~+100 | °C |
| Soldering Temperature | T _{sol} | | Reflow Soldering : 260 °C for 10 sec. Hand Soldering : 350 °C for 3 sec. | |

Note:

The products are sensitive to static electricity and must be carefully taken when handling products.

Electro-Optical Characteristics (T_{Soldering}=25°C)

| Parameter | Symbol | Color | Min. | Typ. | Max. | Unit | Condition |
|---------------------------------|-------------------|-------|-------|-------|-------|------|---------------------|
| Luminous Intensity | I _v | R6 | 14.5 | ----- | 36.0 | mcd | I _F =5mA |
| | | W1 | 90 | ----- | 225 | | |
| Peak Wavelength | λ _p | R6 | ----- | 632 | ----- | nm | I _F =5mA |
| Dominant Wavelength | λ _d | R6 | 617 | ----- | 627 | nm | I _F =5mA |
| Forward Voltage | V _F | R6 | 1.6 | ----- | 2.2 | V | I _F =5mA |
| | | W1 | 2.6 | ----- | 3.1 | | |
| Viewing Angle | 2θ _{1/2} | | ----- | 130 | ----- | deg | I _F =5mA |
| Spectrum Radiation Bandwidth | Δλ | R6 | ----- | 20 | ----- | nm | I _F =5mA |
| Reverse Current | I _R | | ----- | ----- | 10 | μA | V _R =5V |

Notes:

1. Tolerance of Luminous Intensity ±10%.
2. Tolerance of Dominant Wavelength: ±1nm
3. Tolerance of Forward Voltage : ±0.05V.

Bin Code Description

R6: Bin Range of Luminous Intensity

| Bin Code | Min. | Max. | Unit | Condition |
|----------|------|------|------|---------------------|
| LA | 14.5 | 22.5 | mcd | I _F =5mA |
| MA | 22.5 | 36.0 | | |

W1: Bin Range of Luminous Intensity

| Bin Code | Min. | Max. | Unit | Condition |
|----------|------|------|------|---------------------|
| QA | 90 | 140 | mcd | I _F =5mA |
| PA | 140 | 225 | | |

Note:
 Tolerance of Luminous Intensity: ±10%.

W1: Bin Range of Forward Voltage

| Bin Code | Min. | Max. | Unit | Condition |
|----------|------|------|------|---------------------|
| 33 | 2.6 | 2.7 | V | I _F =5mA |
| 34 | 2.7 | 2.8 | | |
| 35 | 2.8 | 2.9 | | |
| 36 | 2.9 | 3.0 | | |
| 37 | 3.0 | 3.1 | | |

Note:
 Tolerance of Forward Voltage: ±0.05V.

Bin Range of Chromaticity Coordinates

| Bin Code | CIE_x | CIE_y | Bin Code | CIE_x | CIE_y |
|----------|--------|--------|----------|--------|--------|
| A3 | 0.2540 | 0.1980 | A4 | 0.2540 | 0.2300 |
| | 0.2540 | 0.2300 | | 0.2540 | 0.2630 |
| | 0.2740 | 0.2580 | | 0.2740 | 0.2910 |
| | 0.2740 | 0.2260 | | 0.2740 | 0.2580 |
| 1 | 0.2740 | 0.2260 | 2 | 0.2740 | 0.2580 |
| | 0.2740 | 0.2580 | | 0.2740 | 0.2910 |
| | 0.2940 | 0.2860 | | 0.2940 | 0.3190 |
| | 0.2940 | 0.2540 | | 0.2940 | 0.2860 |
| 3 | 0.2940 | 0.2540 | 4 | 0.2940 | 0.2860 |
| | 0.2940 | 0.2860 | | 0.2940 | 0.3190 |
| | 0.3140 | 0.3150 | | 0.3140 | 0.3470 |
| | 0.3140 | 0.2820 | | 0.3140 | 0.3150 |

Note:
1. The value is based on driving current by 5mA.
2. Tolerance of Chromaticity Coordinates: ±0.01

The C.I.E. 1931 Chromaticity Diagram

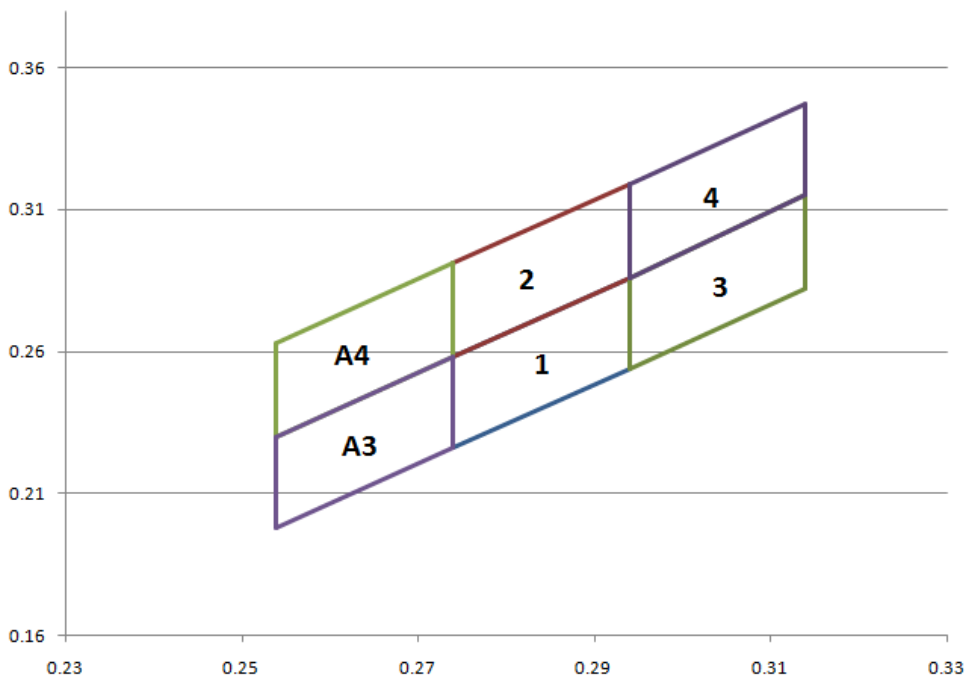

R6: Spectrum Distribution

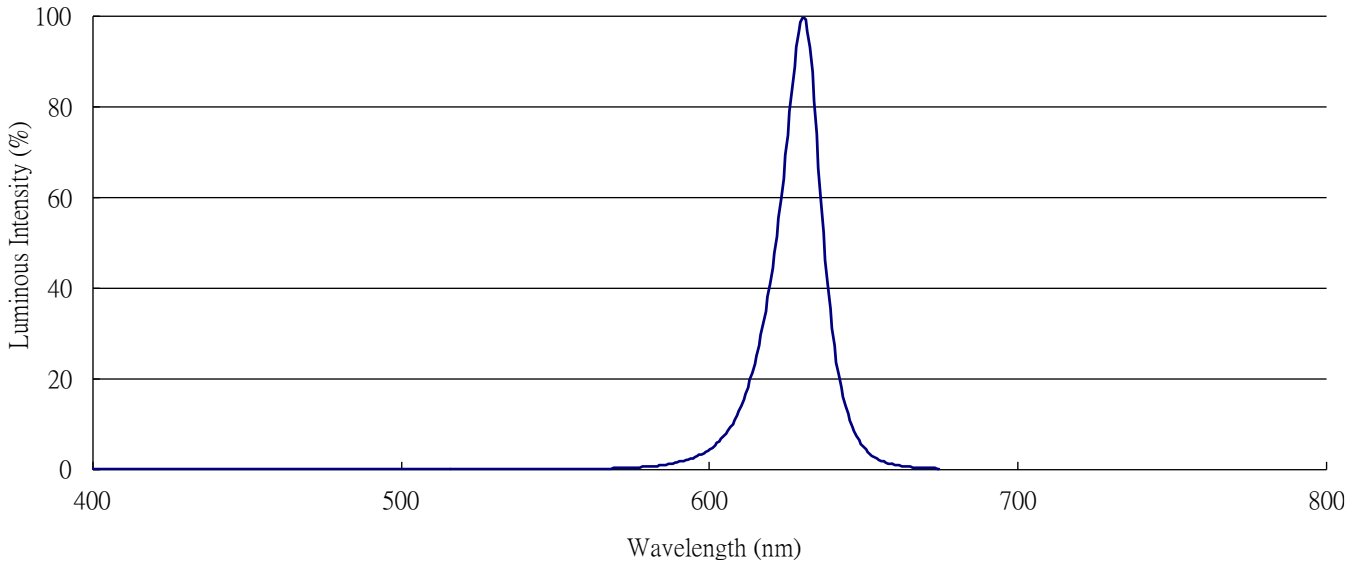

W1: Spectrum Distribution

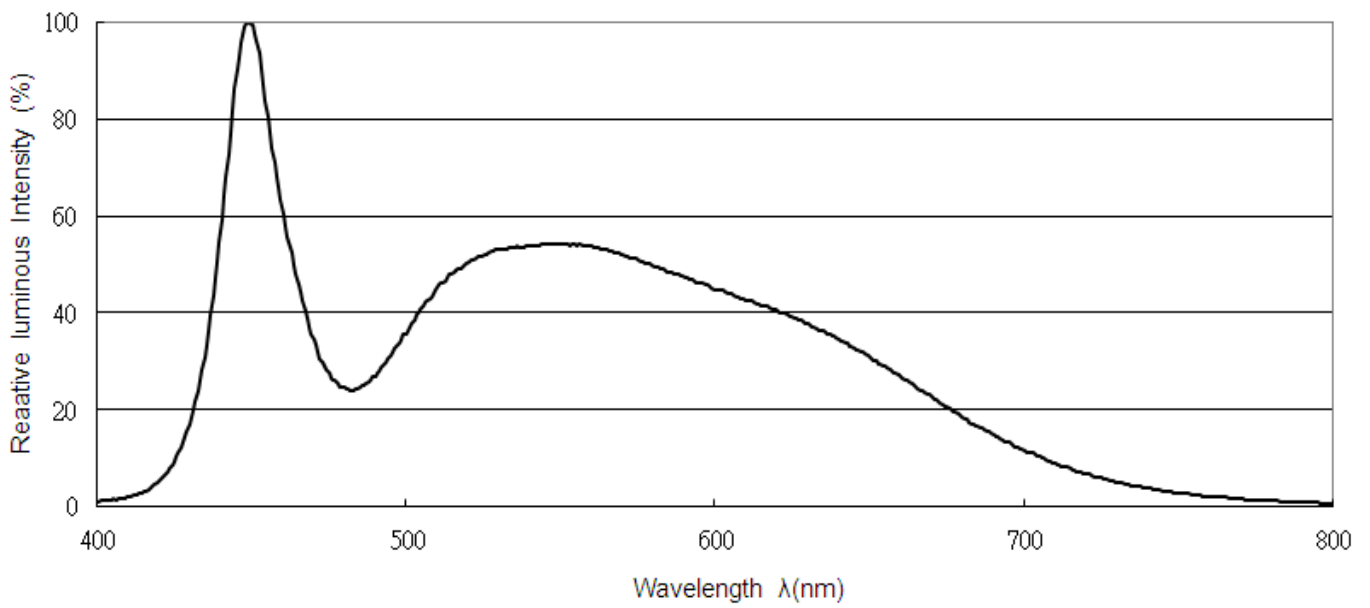

Typical Electro-Optical Characteristics Curve (Chip code: R6)

Fig.1-Forward Voltage Shift vs. Junction Temperature

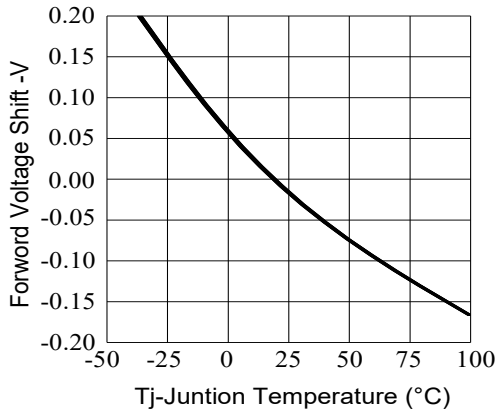

Fig.2-Relative Luminous Intensity vs. Forward Current

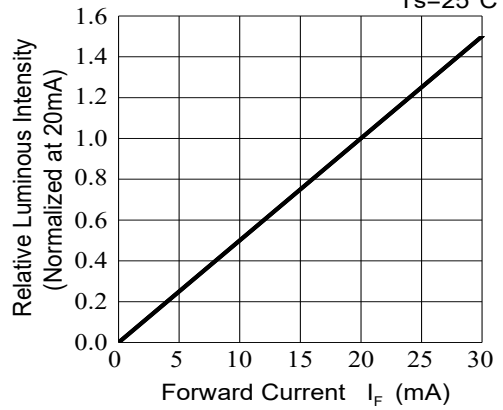

Fig.3-Relative Luminous Intensity vs. Junction Temperature

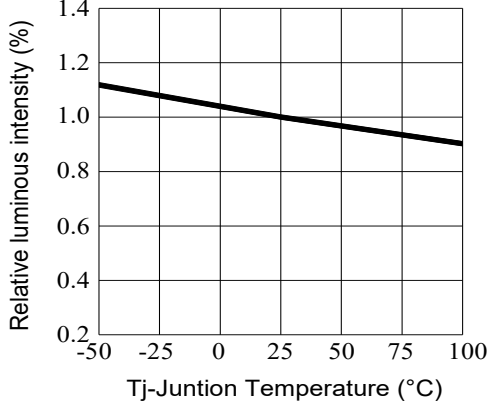

Fig.4-Forward Current vs. Forward Voltage

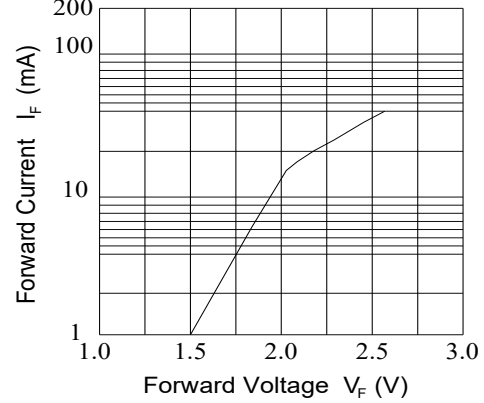

Fig.5-Max. Driving Forward Current vs. Soldering Temperature

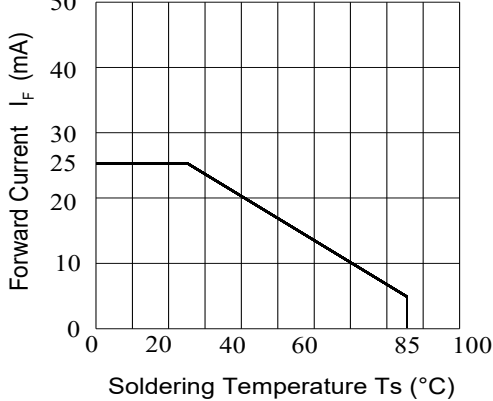
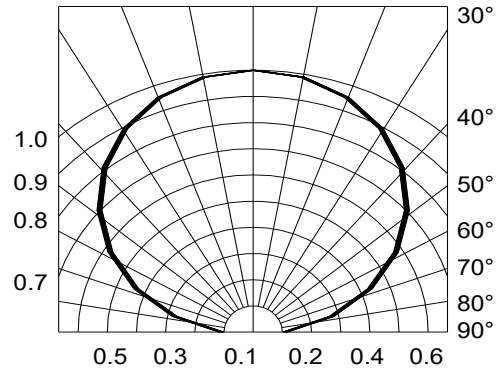

Fig.6-Radiation Diagram



Typical Electro-Optical Characteristics Curve (Chip code: W1)

Fig.1-Forward Voltage Shift vs. Junction Temperature

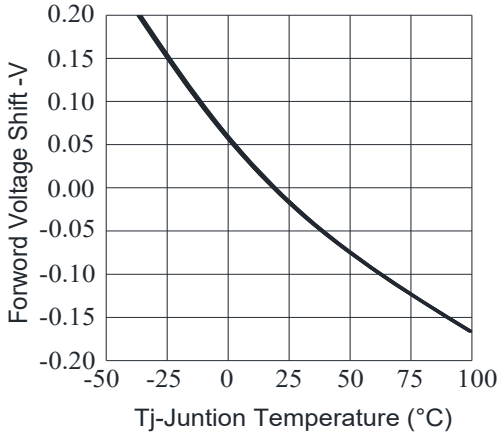

Fig.2-Relative Luminous Intensity vs. Forward Current

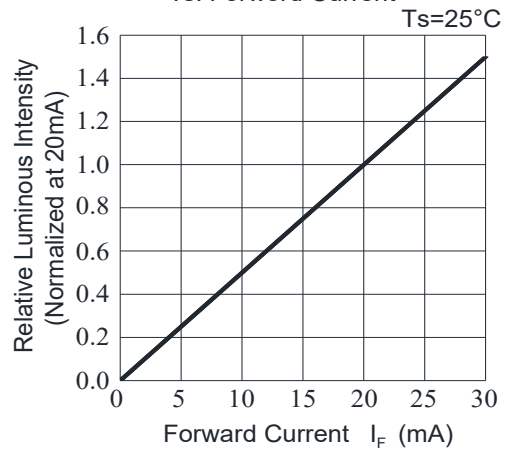

Fig.3-Relative Luminous Intensity vs. Junction Temperature

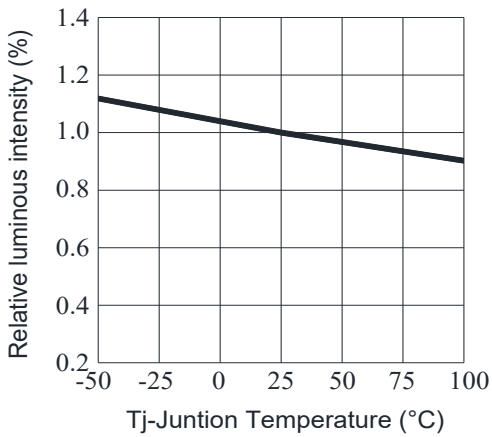

Fig.4-Forward Current vs. Forward Voltage

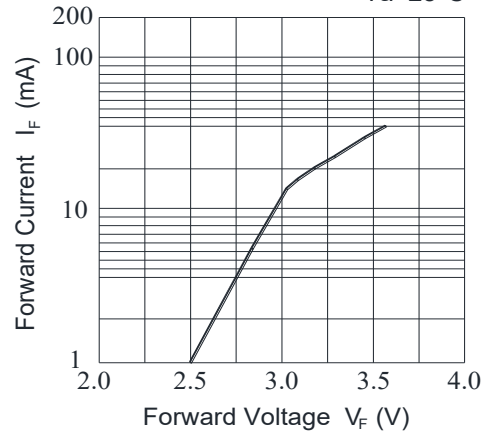

Fig.5-Max. Driving Forward Current vs. Soldering Temperature

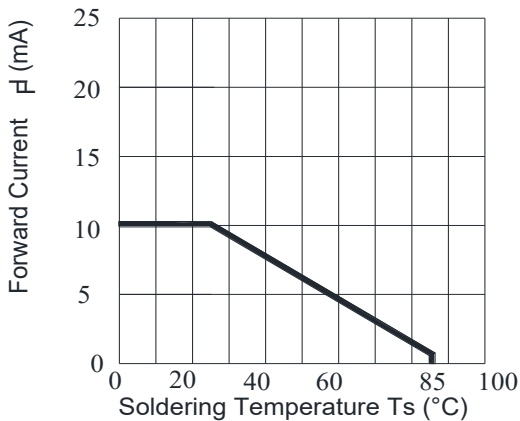
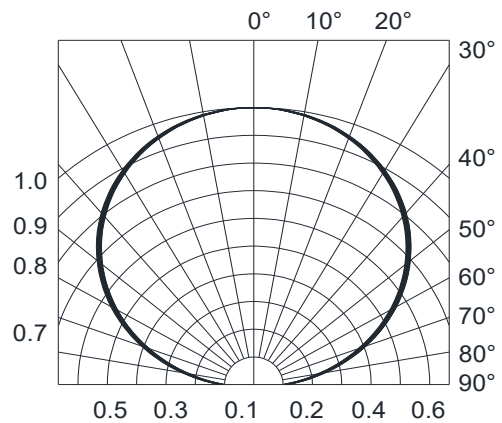
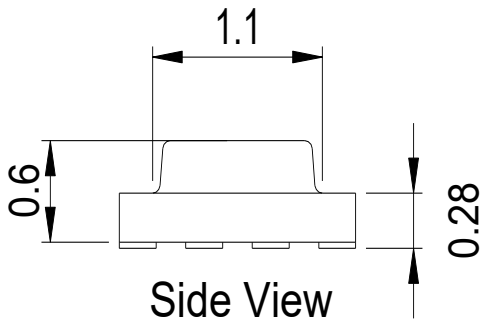
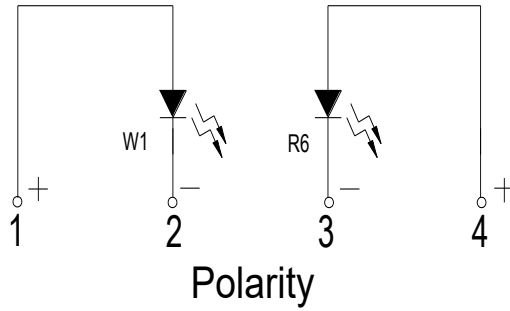
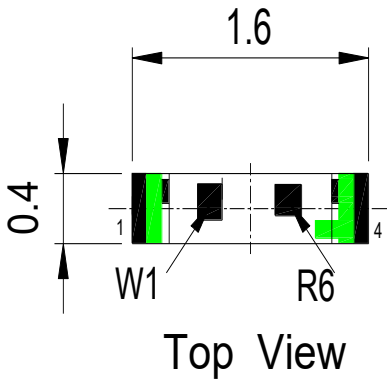

Fig.6-Radiation Diagram



Package Dimension



Recommended Solder Pad

(Used Solder paste NO.5 -96.5%Sn/3.0%Ag/0.5%Cu,
 $\phi 15\sim 25\mu\text{m}$, H:0.1~0.125 μm)

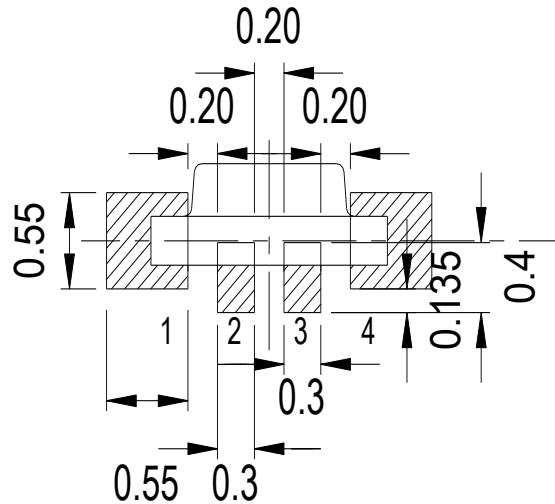
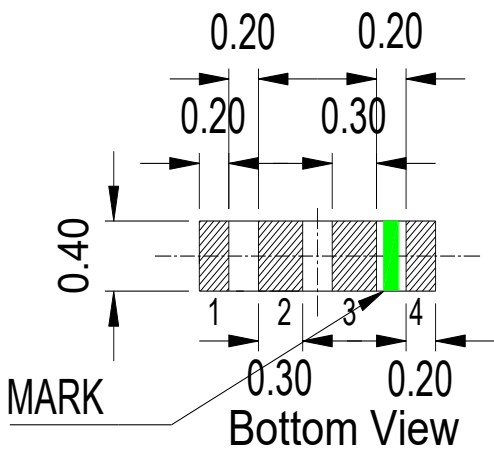

Note:
 Tolerance unless mentioned is $\pm 0.1\text{mm}$, Unit = mm.

**Moisture Resistant Packing Materials
 Label Explanation**

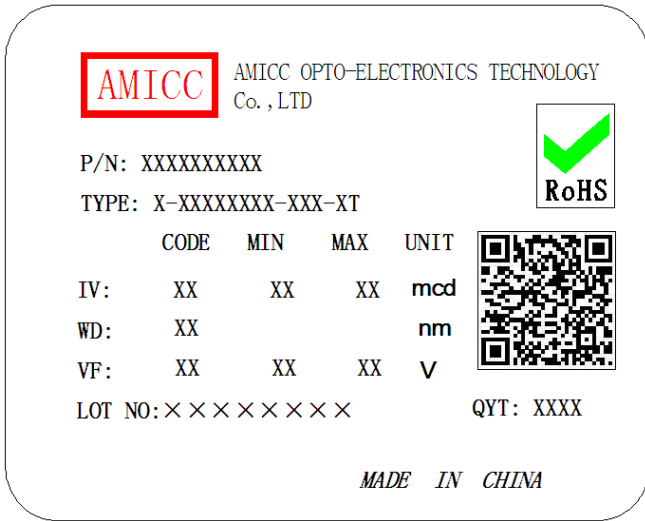

- CPN: Customer's Product Number
- P/N: Product Number
- TYPE :Part NO.
- IV: Luminous Intensity Rank
- WD: Dom. Wavelength Rank
- VF: Forward Voltage Rank
- LOT NO.: Lot Number
- QTY: Packing Quantity

Reel Dimensions

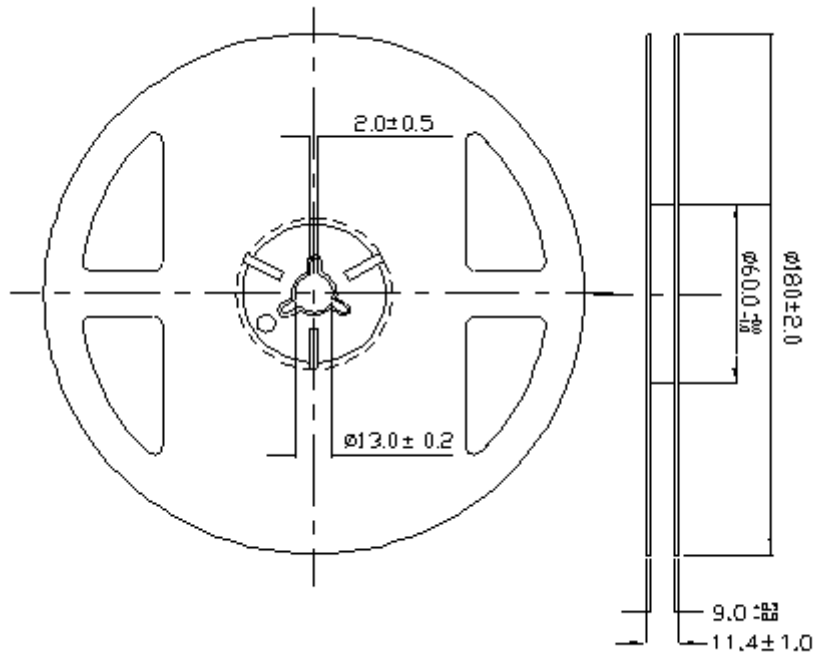

Note:
 Tolerances unless mentioned ± 0.1 mm, Unit = mm.

Carrier Tape Dimensions: Loaded Quantity 3000 pcs Per Reel

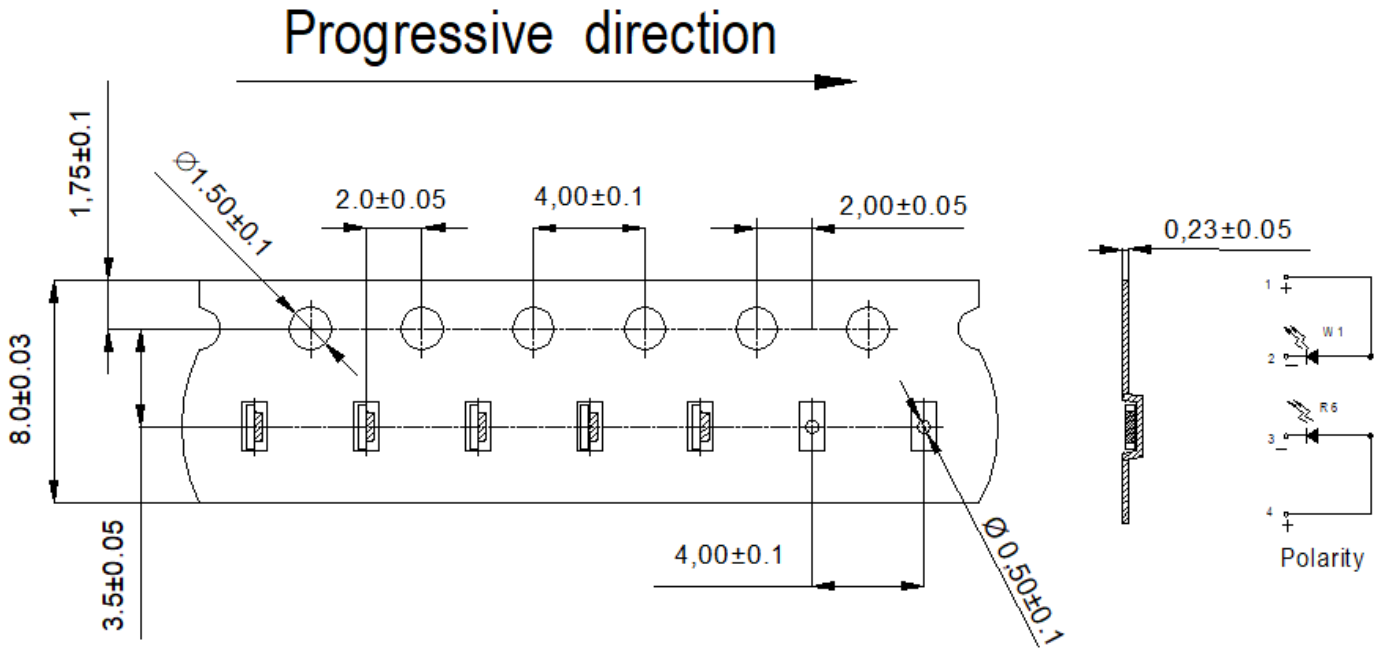

Notes:

1. Tolerance unless mentioned is ± 0.1 mm, Unit = mm.
2. Minimum packing amount is 1000/2000 pcs per reel.

Moisture Resistant Packing Process

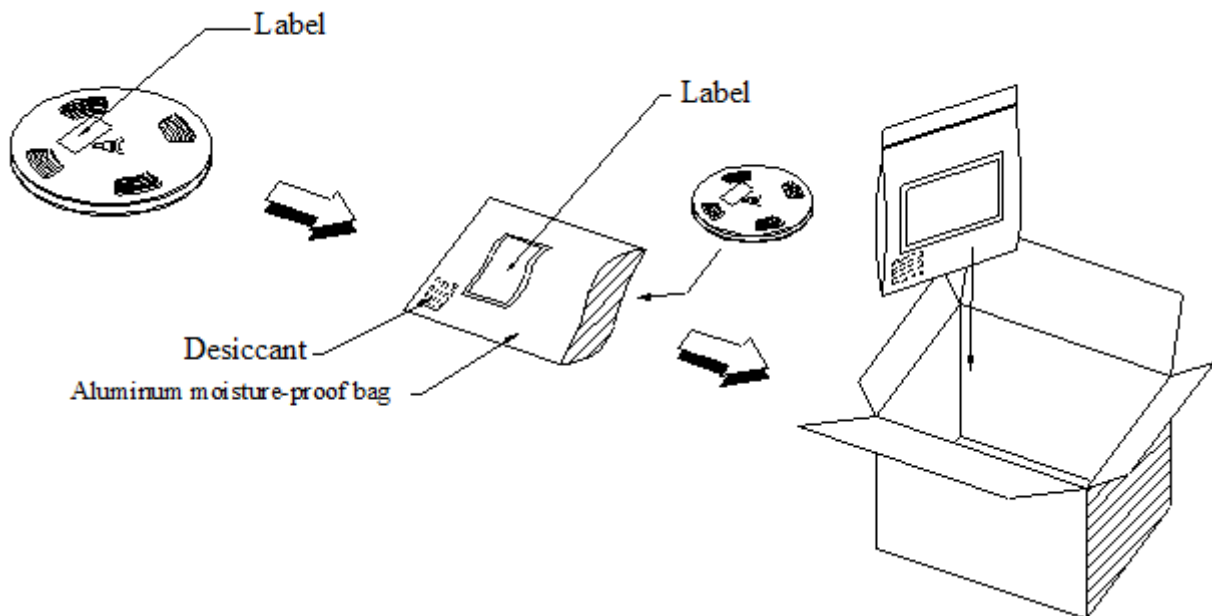

Reliability Test Items and Conditions

The reliability of products shall be satisfied with items listed below.

Confidence level : 90%

LTPD : 10%

| No. | Items | Test Condition | Test Hours/Cycles | Sample Size | Ac/Re |
|-----|---------------------------|--|-------------------|-------------|-------|
| 1 | Reflow Soldering | Temp. : 260°C/10sec. | 6 Min. | 22 PCS. | 0/1 |
| 2 | Thermal Shock | H : +100°C 5min § 10 sec L : -10°C 5min | 300 Cycles | 22 PCS. | 0/1 |
| 3 | Temperature Cycle | H : +100°C 15min § 5 min L : -40°C 15min | 300 Cycles | 22 PCS. | 0/1 |
| 4 | High Temperature/Humidity | Ta=85°C,85%RH | 1000 Hrs. | 22 PCS. | 0/1 |
| 5 | Low Temperature Storage | Ta=-40°C | 1000 Hrs. | 22 PCS. | 0/1 |
| 6 | High Temperature Storage | Ta=100°C | 1000 Hrs. | 22 PCS. | 0/1 |
| 7 | DC Operation Life | Ta=25°C, I _F = 5 mA | 1000 Hrs. | 22 PCS. | 0/1 |

Precautions for Use

1. Over-current-proof

Customer must apply resistors for protection; otherwise slight voltage shift will cause big current change (Burn out will happen).

2. Storage

2.1 Do not open moisture proof bag before the products are ready to use.

2.2 Before opening the package: The LEDs should be kept at 30°C or less and 90%RH or less.

2.3 After opening the package: The LED's floor life is 1 year under 30°C or less and 60% RH or less. If unused LEDs remain, it should be stored in moisture proof packages.

2.4 If the moisture absorbent material (silica gel) has faded away or the LEDs have exceeded the storage time, baking treatment should be performed using the following conditions.

Baking treatment: 60±5°C for 24 hours.

3. Soldering Condition

3.1 Pb-free solder temperature profile

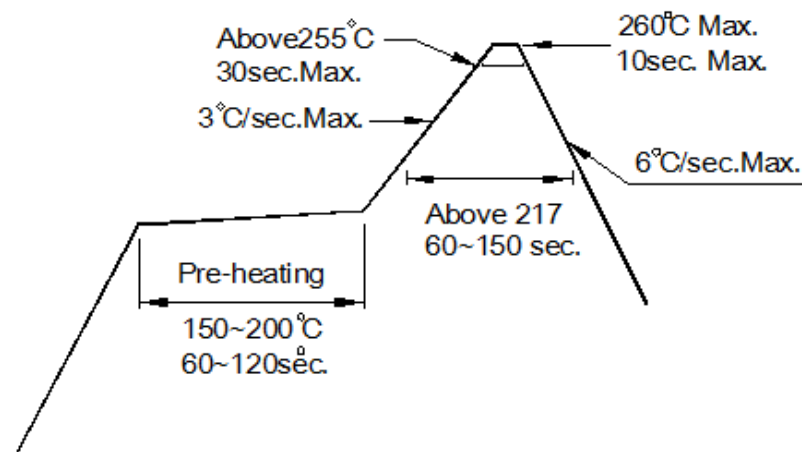

3.2 Reflow soldering should not be done more than two times.

3.3 When soldering, do not put stress on the LEDs during heating.

3.4 After soldering, do not warp the circuit board.

4. Soldering Iron

Each terminal is to go to the tip of soldering iron temperature less than 350°C for 3 seconds within once in less than the soldering iron capacity 25W. Leave two seconds and more intervals, and do soldering of each terminal. Be careful because the damage of the product is often started at the time of the hand solder.

5. Repairing

Repair should not be done after the LEDs have been soldered. When repairing is unavoidable, a double-head soldering iron should be used (as below figure). It should be confirmed beforehand whether the characteristics of the LEDs will or will not be damaged by repairing.

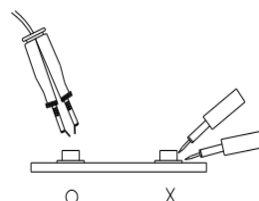

X-ON Electronics

Largest Supplier of Electrical and Electronic Components

Click to view similar products for [Amicc manufacturer](#):

Other Similar products are found below :

[A-SP192GB1D-B01-4T\(HW\)](#) [A-SP1512R6GHC-A01-2A](#) [A-SA3HR334GYRD019](#) [A-SA3HR314GGGGW033-H440](#) [A-SA6S6091RPGCE070-CA](#) [A-SA3HR314GGW026-H22](#) [A-SA3HR324GW014](#) [AM817S\(B\)\(T1\)-FG](#) [A-IRM38G17SC9](#) [A-SA3HR314GD007-H11](#) [A-IA3R326CIR1C-D](#) [A-SA5HR503RG022-H6101](#) [A-SA3R3140RBWE073-CA](#) [A-SP110B1C-C01-2C](#) [A-SA3HR3040SRDN122-H11](#) [A-SA3HR314RGW029-H22](#) [A-SP153IR1C-A02-2D](#) [A-SP192YW1D-D04-4T](#) [A-SI2020R6AGHB1C-C01-2T](#) [AM816S\(B\)\(T1\)-CG](#) [A-SP192CW1D-C06-4T](#) [A-SC6303AR6AGHY3AC-A01-2T](#) [A-SP194R6C-C01-3T](#) [A-SP1103R6AGHB1W-C01-2C](#) [A-SC880IR3C-P03-1T](#) [A-SC667R6AGHB1W-A01-1T](#) [A-SP110W1D-C03-2C](#) [A-SP1502R6W1D-A01-2T](#) [A-SP110R6C-C01-2C](#) [A-SC6302B1R6C-A02-2T](#) [A-SP150B1C-A01-3T](#) [A-SP153IR1C-A02-2T](#) [A-SP1103R6GHB1W-C01-2C](#) [A-SA3R302BWCE062-30](#) [A-SA3R3040BWCE061](#) [A-SL660B1C-C01-4T](#) [A-SP170B1C-C02-3T](#) [A-SP150Y3AC-A01-3T](#) [A-SP192GS1D-C01-4T](#) [A-SP1102DR6W1D-C01-2C](#) [A-SP1923XR6GHB1C-A01-3T](#) [A-SP110GHC-C01-2C](#) [A-SP110W1D-C01-2C](#) [A-SC6303R6AGHB1C-A01-2T](#) [A-SP1942R5G2C-C01-2T](#) [A-SP158IR1C-A02-2D](#) [A-SP192YR6C-A01-4T](#) [A-SC6302R6AGHC-A03-2T](#) [A-SP150R6AC-A01-3T](#) [A-SP194ZW1D-C07-4T](#)