

客户 (Customer) : _____

承认书

Approval Sheet

谨致执事者：兹提供敝公司之有关详细规格及图面数据, 敬请给予办理试认定手续。
同时敬请送返一份附有贵公司签认之测试认定后之样品承认书。

We are pleased in sending you herewith on specification and drawings for your approval.
Please return to us one copy "Approval sheet" with your approved signature.

型号 (Model No.) : A-SP192SS1C-C01-3C

发文日期 (Issue Date) : 2014/04/17 承认日期 (Approved Date) : _____

Checking signature of Amicc

Designer	Checker	Approver
Doron		

Approval signature of customer

Designer	Checker	Approver

常州市欧密格光电科技有限公司
Changzhou Amicc Opto-Electronics Technology Co.LTD
江苏省常州市湖塘鸣凰沟南工业区
GouNan industrial park HuTang ChangZhou
TEL:0086-519-86525868
FAX:0086-519-86523668

Mono-Color Type ■ Side view 0603 Package

A-SP192SS1C-C01-3C

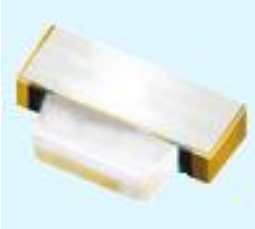

Features

- 0603 package
- Side view LED
- Compatible with infrared and vapor phase reflow solder process.
- Wide viewing angle
- Pb-free
- RoHS compliant

Description

The Amicc 192S package has high efficacy, high power consumption, wide viewing angle and a compact form factor. These features make this package an ideal LED for all lighting applications.

Applications

- General lighting
- Decorative and Entertainment Lighting
- Indicators
- Automotive Telecommunication
- Switch lights

Device Selection Guide

Chip Materials	Emitted Color	Resin Color
AlGaInP	Brilliant Orange	Water Clear

Absolute Maximum Ratings (T_{Soldering}=25°C)

Parameter	Symbol	Rating	Unit
Forward Current	I _F	25	mA
Peak Forward Current (Duty 1/10 @1ms)	I _{FP}	60	mA
Power Dissipation	P _d	60	mW
Operating Temperature	T _{opr}	-40 ~ +85	°C
Storage Temperature	T _{stg}	-40 ~ +100	°C
Electrostatic Discharge(HBM)	ESD	2000	V
Soldering Temperature	T _{sol}	Reflow Soldering : 260 °C for 10 sec. Hand Soldering : 350 °C for 3 sec.	

Note:

The products are sensitive to static electricity and must be carefully taken when handling products.

Electro-Optical Characteristics (T_{Soldering}=25°C)

Parameter	Symbol	Min.	Typ.	Max.	Unit	Condition
Luminous Intensity	I _v	22.5	-----	72.0	mcd	I _F =5mA
Peak Wavelength	λ _p	-----	611	-----	nm	I _F =5mA
Dominant Wavelength	λ _d	600.5	-----	612.5	nm	I _F =5mA
Forward Voltage	V _F	1.6	-----	2.1	V	I _F =5mA
Viewing Angle	2θ _{1/2}	-----	120	-----	deg	I _F =5mA
Reverse Current	I _R	-----	-----	10	μA	V _R =5V

Notes:

1. Tolerance of Luminous Intensity ±10%.
2. Tolerance of Dominant Wavelength: ±1nm.
3. Tolerance of Forward Voltage : ±0.05V.

Bin Range of Luminous Intensity

Bin Code	Min.	Max.	Unit	Condition
AM2	22.5	28.5	mcd	$I_F=5mA$
AN1	28.5	36.0		
AN2	36.0	45.0		
AP1	45.0	57.0		
AP2	57.0	72.0		

Note:
 Tolerance of Luminous Intensity: $\pm 10\%$.

Bin Range of Dominant Wavelength

Bin Code	Min.	Max.	Unit	Condition
S8	600.5	603.5	nm	$I_F=5mA$
S9	603.5	606.5		
S10	606.5	609.5		
S11	609.5	612.5		

Note:
 Tolerance of Dominant Wavelength: $\pm 1nm$.

Bin Range of Forward Voltage

Bin Code	Min.	Max.	Unit	Condition
17	1.6	1.7	V	$I_F=5mA$
18	1.7	1.8		
19	1.8	1.9		
20	1.9	2.0		
21	2.0	2.1		

Note:
 Tolerance of Forward Voltage: $\pm 0.05V$.

Spectrum Distribution

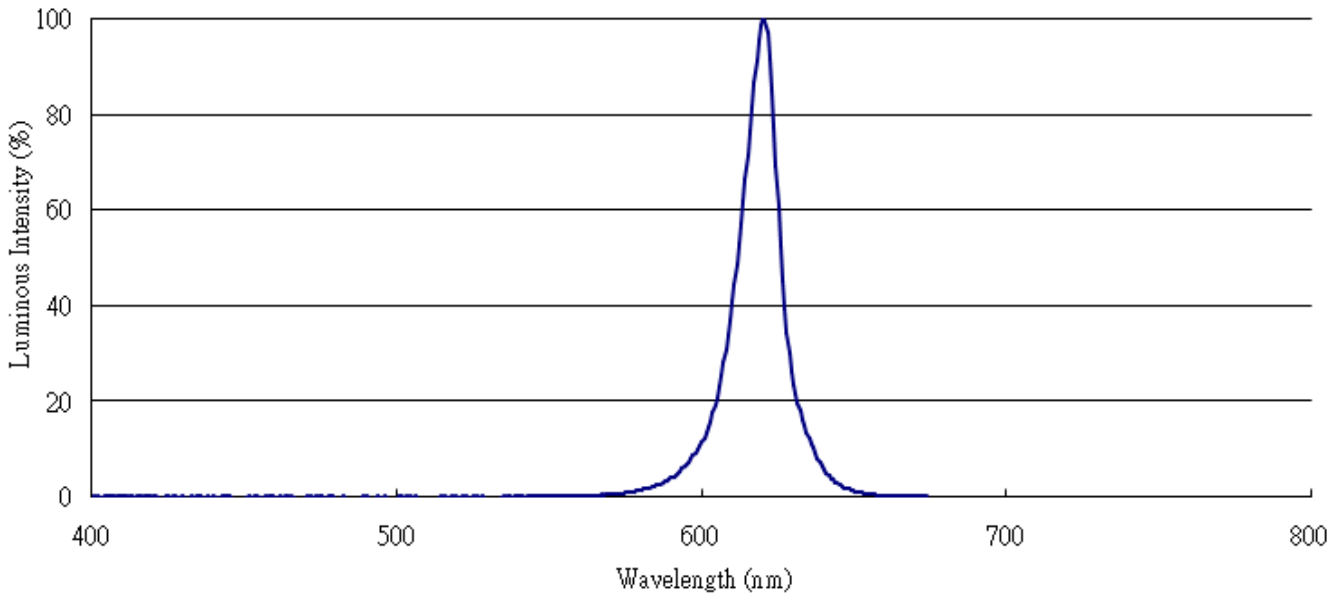

Typical Electro-Optical Characteristics Curves

Fig.1 - Forward Voltage Shift vs. Junction Temperature

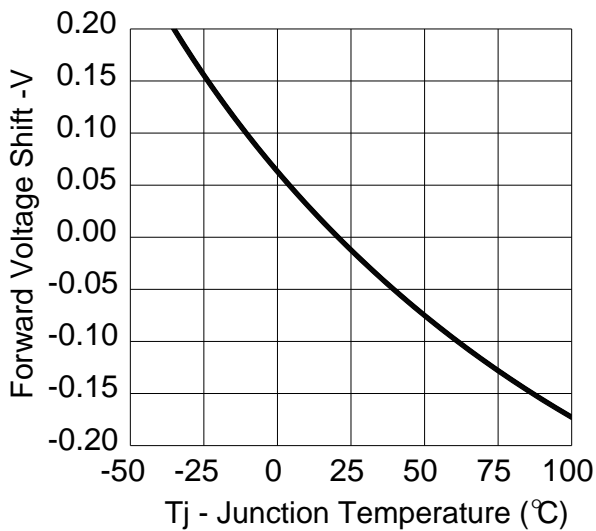
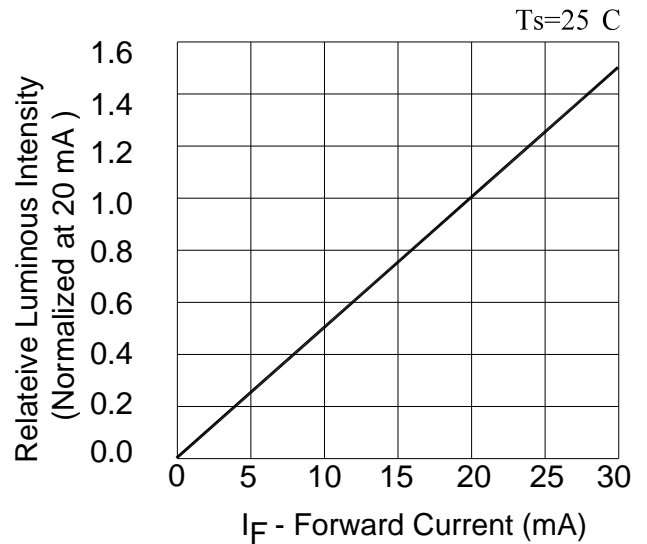

Fig.2 - Relative Luminous Intensity vs. Forward Current



Typical Electro-Optical Characteristics Curves

Fig.3-Relative Luminous Intensity vs.Junition Temperature

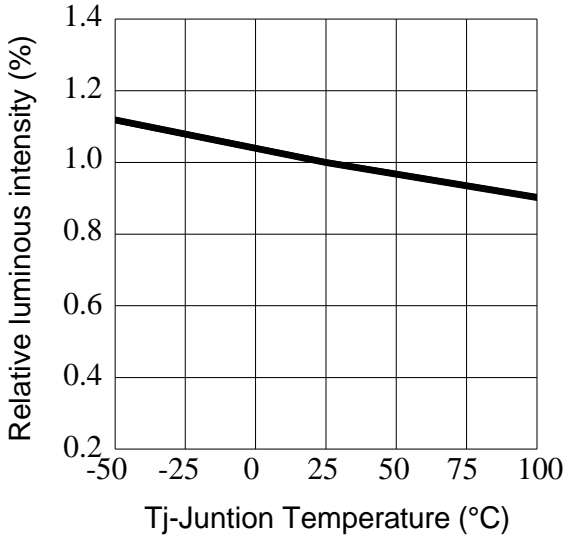

Fig.4-Forward Current vs. Forward Voltage T_a=25°C

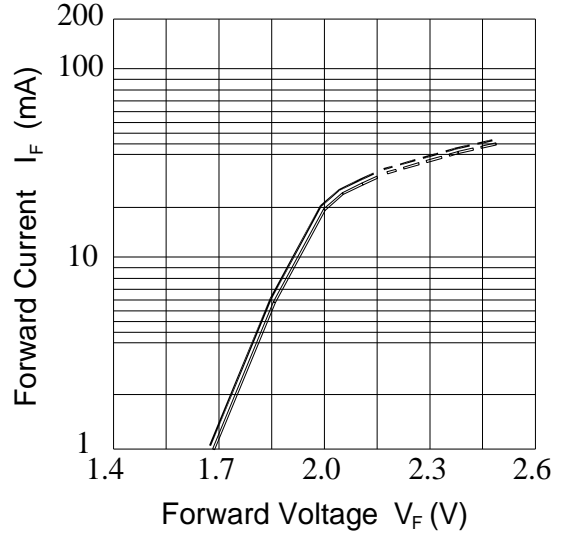

Fig.5-Max.Driving Forward Current vs.Soldering Temperature

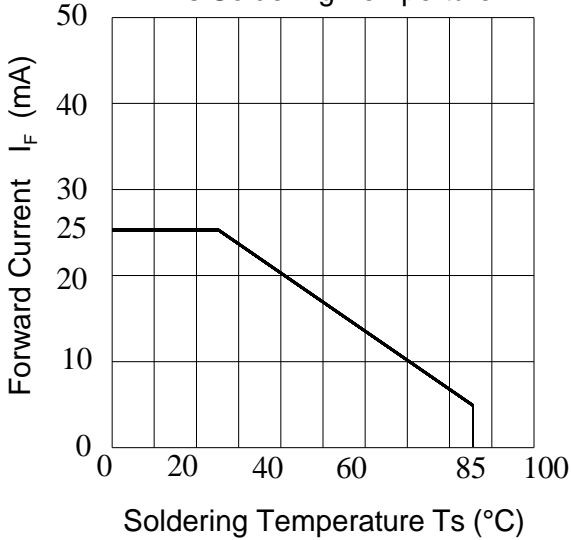
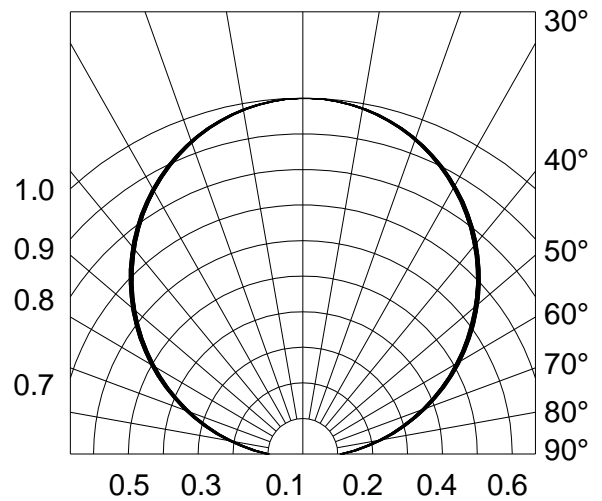
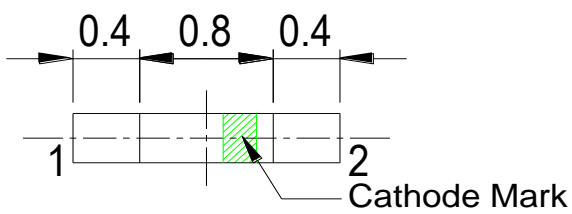
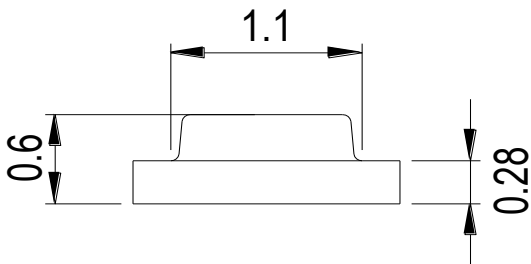
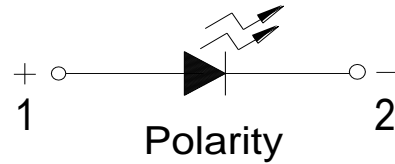
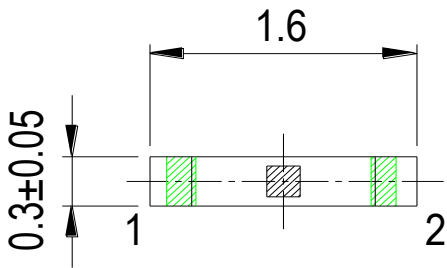

Fig.6-Radiation Diagram T_a=25°C



Package Dimension



Recommended Solder Pad

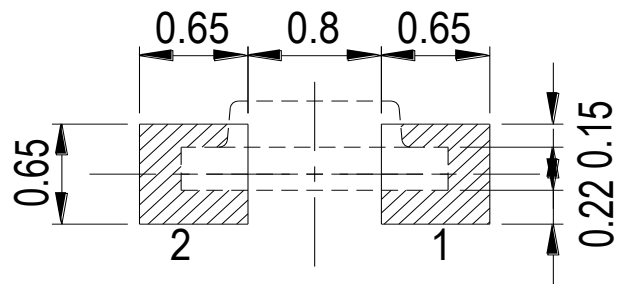

Note:
Tolerance unless mentioned is ± 0.1 mm, Unit = mm.

Moisture Resistant Packing Materials

Label Explanation

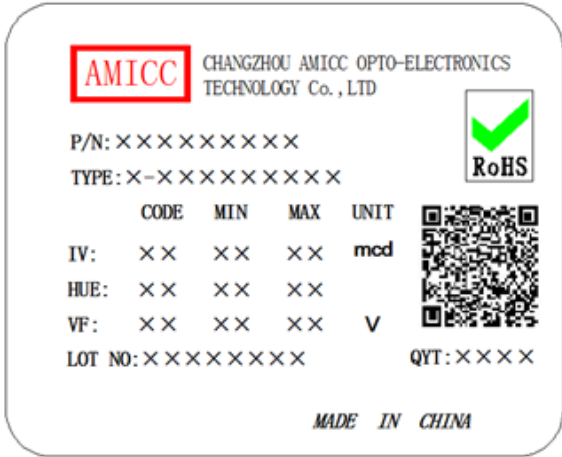

- CPN: Customer's Product Number
- P/N: Product Number
- QTY: Packing Quantity
- CAT: Luminous Intensity Rank
- HUE: Dom. Wavelength Rank
- REF: Forward Voltage Rank
- LOT No: Lot Number

Reel Dimensions

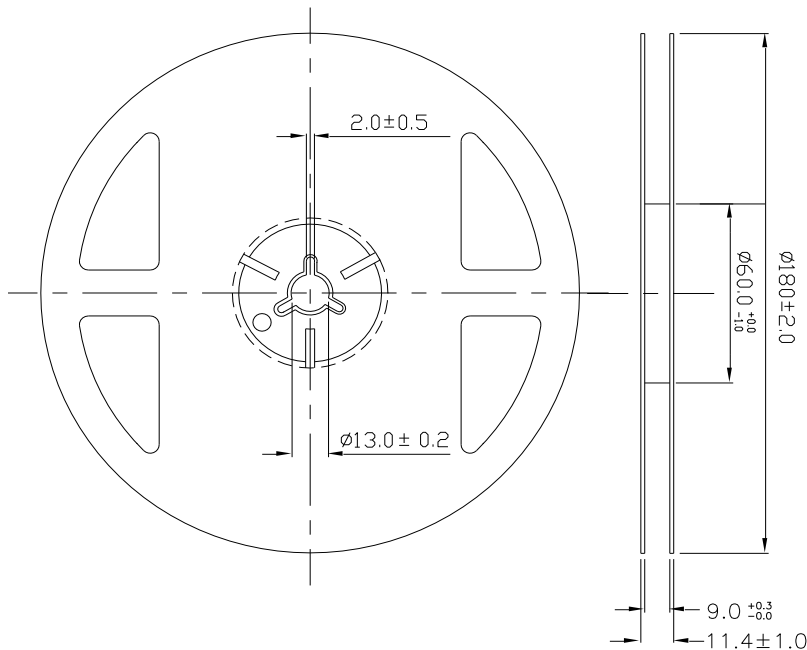

Note:
 Tolerances unless mentioned ±0.1mm, Unit = mm.

Carrier Tape Dimensions: Loaded Quantity 3000 pcs Per Reel

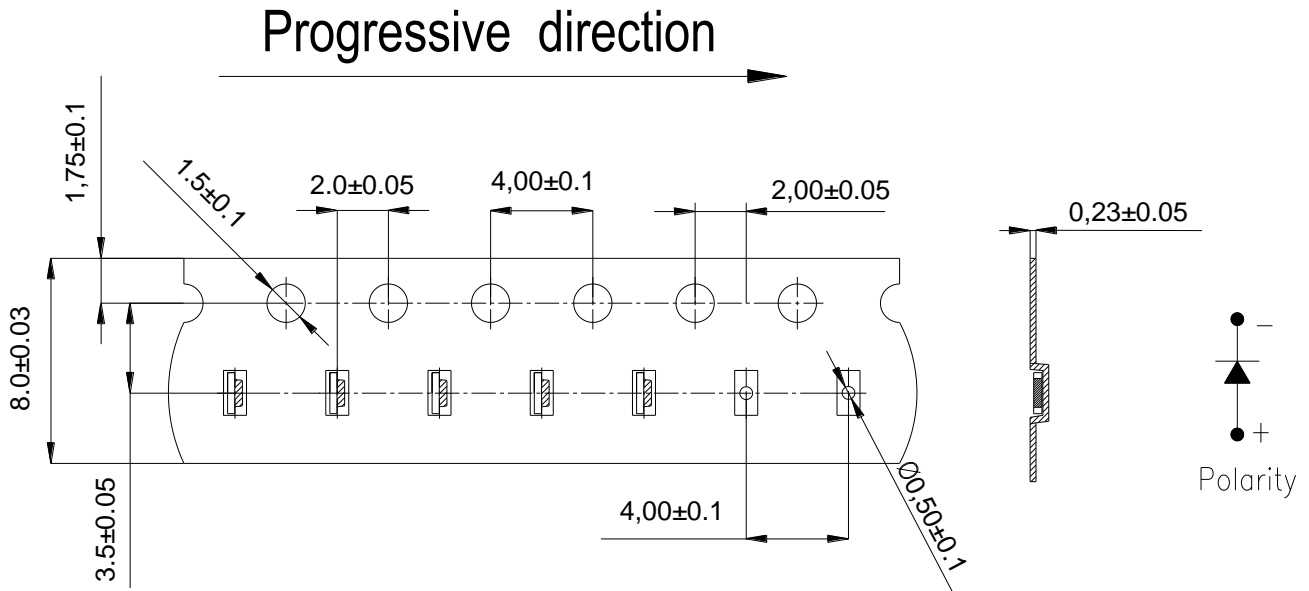

- Note:
1. Tolerance unless mentioned is ± 0.1 mm, Unit = mm.
 2. Minimum packing amount is 1000/2000 pcs per reel.

Moisture Resistant Packing Process

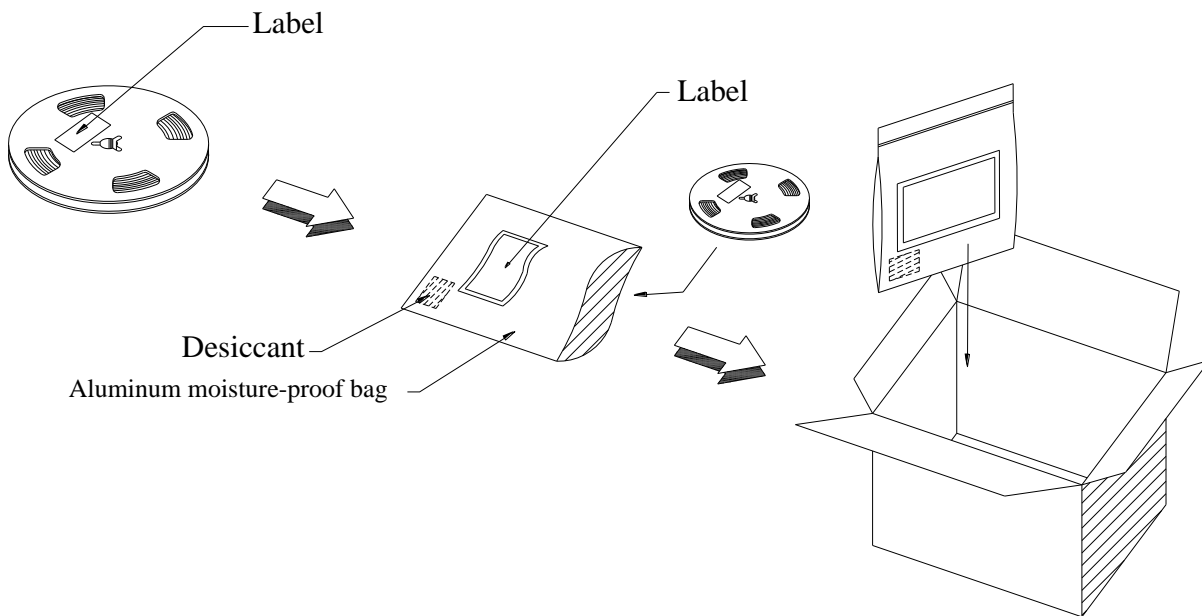

Reliability Test Items and Conditions

The reliability of products shall be satisfied with items listed below.
 Confidence level : 90%
 LTPD : 10%

No.	Items	Test Condition	Test Hours/Cycles	Sample Size	Ac/Re
1	Reflow Soldering	Temp. : 260°C/10sec.	6 Min.	22 PCS.	0/1
2	Thermal Shock	H : +100°C 5min § 10 sec L : -10°C 5min	300 Cycles	22 PCS.	0/1
3	Temperature Cycle	H : +100°C 15min § 5 min L : -40°C 15min	300 Cycles	22 PCS.	0/1
4	High Temperature/Humidity Reverse Bias	Ta=85°C,85%RH	1000 Hrs.	22 PCS.	0/1
5	Low Temperature Storage	Ta=-40°C	1000 Hrs.	22 PCS.	0/1
6	High Temperature Storage	Ta=100°C	1000 Hrs.	22 PCS.	0/1
7	DC Operation Life	Ta=25°C, I _F = 20 mA	1000 Hrs.	22 PCS.	0/1

Precautions for Use

1. Over-current-proof

Customer must apply resistors for protection; otherwise slight voltage shift will cause big current change (Burn out will happen).

2. Storage

2.1 Do not open moisture proof bag before the products are ready to use.

2.2 Before opening the package: The LEDs should be kept at 30°C or less and 90%RH or less.

2.3 After opening the package: The LED's floor life is 1 year under 30°C or less and 60% RH or less. If unused LEDs remain, it should be stored in moisture proof packages.

2.4 If the moisture absorbent material (silica gel) has faded away or the LEDs have exceeded the storage time, baking treatment should be performed using the following conditions.

Baking treatment: 60±5°C for 24 hours.

3. Soldering Condition

3.1 Pb-free solder temperature profile

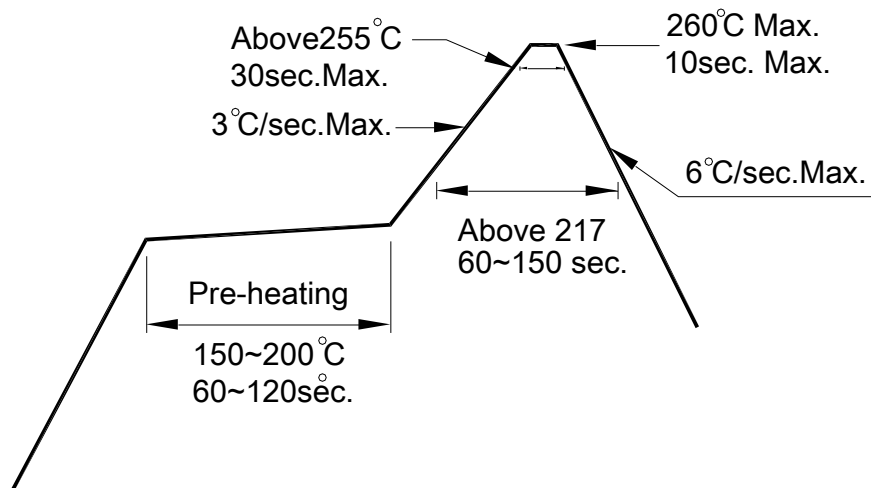

3.2 Reflow soldering should not be done more than two times.

3.3 When soldering, do not put stress on the LEDs during heating.

3.4 After soldering, do not warp the circuit board.

4. Soldering Iron

Each terminal is to go to the tip of soldering iron temperature less than 350°C for 3 seconds within once in less than the soldering iron capacity 25W. Leave two seconds and more intervals, and do soldering of each terminal. Be careful because the damage of the product is often started at the time of the hand solder.

5. Repairing

Repair should not be done after the LEDs have been soldered. When repairing is unavoidable, a double-head soldering iron should be used (as below figure). It should be confirmed beforehand whether the characteristics of the LEDs will or will not be damaged by repairing.

X-ON Electronics

Largest Supplier of Electrical and Electronic Components

Click to view similar products for [Amicc manufacturer](#):

Other Similar products are found below :

[A-SP192GB1D-B01-4T\(HW\)](#) [A-SP1512R6GHC-A01-2A](#) [A-SA3HR334GYRD019](#) [A-SA3HR314GGGGW033-H440](#) [A-SA6S6091RPGCE070-CA](#) [A-SA3HR314GGW026-H22](#) [A-SA3HR324GW014](#) [AM817S\(B\)\(T1\)-FG](#) [A-IRM38G17SC9](#) [A-SA3HR314GD007-H11](#) [A-IA3R326CIR1C-D](#) [A-SA5HR503RG022-H6101](#) [A-SA3R3140RBWE073-CA](#) [A-SP110B1C-C01-2C](#) [A-SA3HR3040SRDN122-H11](#) [A-SA3HR314RGW029-H22](#) [A-SP153IR1C-A02-2D](#) [A-SP192YW1D-D04-4T](#) [A-SI2020R6AGHB1C-C01-2T](#) [AM816S\(B\)\(T1\)-CG](#) [A-SP192CW1D-C06-4T](#) [A-SC6303AR6AGHY3AC-A01-2T](#) [A-SP194R6C-C01-3T](#) [A-SP1103R6AGHB1W-C01-2C](#) [A-SC880IR3C-P03-1T](#) [A-SC667R6AGHB1W-A01-1T](#) [A-SP110W1D-C03-2C](#) [A-SP1502R6W1D-A01-2T](#) [A-SP110R6C-C01-2C](#) [A-SC6302B1R6C-A02-2T](#) [A-SP150B1C-A01-3T](#) [A-SP153IR1C-A02-2T](#) [A-SP1103R6GHB1W-C01-2C](#) [A-SA3R302BWCE062-30](#) [A-SA3R3040BWCE061](#) [A-SL660B1C-C01-4T](#) [A-SP170B1C-C02-3T](#) [A-SP150Y3AC-A01-3T](#) [A-SP192GS1D-C01-4T](#) [A-SP1102DR6W1D-C01-2C](#) [A-SP1923XR6GHB1C-A01-3T](#) [A-SP110GHC-C01-2C](#) [A-SP110W1D-C01-2C](#) [A-SC6303R6AGHB1C-A01-2T](#) [A-SP1942R5G2C-C01-2T](#) [A-SP158IR1C-A02-2D](#) [A-SP192YR6C-A01-4T](#) [A-SC6302R6AGHC-A03-2T](#) [A-SP150R6AC-A01-3T](#) [A-SP194ZW1D-C07-4T](#)