

客户 (Customer) : _____

承认书

Approval Sheet

谨致执事者：兹提供敝公司之有关详细规格及图面数据，敬请给予办理试认定手续。
同时敬请送返一份附有贵公司签认之测试认定后之样品承认书。

We are pleased in sending you herewith on specification and drawings for your approval.
Please return to us one copy "Approval sheet" with your approved signature.

型号 (Model No.) : A-SP1943AB1R6AGHC-C01-2T

发文日期 (Issue Date) : 2017/1/11 承认日期 (Approved Date) : _____

Checking signature of Amicc

Designer	Checker	Approver
Silence	Allen	<i>jeff</i>

Approval signature of customer

Designer	Checker	Approver

江苏欧密格光电科技股份有限公司

Jiangsu Amicc Opto-Electronics Technology Co.,Ltd.

地址: 江苏省常州市武进区武南中路 98 号

Add: 98.Wu Nan Road, Wujin, Changzhou city, Jiangsu Province

TEL:0086-519-89806973

FAX:0086-519-86523668

Multi-Color Type ■ Top view Full-color A-SP1943AB1R6AGHC-C01-2T

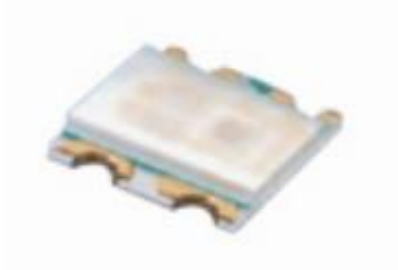

Features

- Multi-Color Type
- Compatible with infrared and vapor phase reflow solder process.
- Wide viewing angle
- Pb-free
- RoHS compliant

Description

- The Amicc 1943A SMD LED is much smaller than lead frame type components, thus enable smaller board size, higher packing density, reduced storage space and finally smaller equipment to be obtained.
- Besides, lightweight makes them ideal for miniature applications etc.

Applications

- LCD Back-light
- Decorative and Entertainment Lighting
- Indicators
- Automotive Telecommunication
- Switch lights

Device Selection Guide

Type	Chip Materials	Emitted Color	Resin Color
R6	AlGaInp	Brilliant Red	Water Clear
GH	InGaN	Green	
B1	InGaN	Blue	

Absolute Maximum Ratings (T_{Soldering}=25°C)

Parameter	Symbol	Color	Rating	Unit
Reverse Voltage	V _R		5	V
Forward Current	I _F		25	mA
Peak Forward Current (Duty 1/10 @1ms)	I _{FP}	R6	80	mA
		GH	100	
		B1	100	
Power Dissipation	P _d	R6	75	mW
		GH	100	
		B1	100	
Electrostatic Discharge(HBM)	ESD	R6	2000	V
		GH	1000	
		B1	1000	
Operating Temperature	T _{opr}		-40~+85	°C
Storage Temperature	T _{stg}		-40~+85	°C
Soldering Temperature	T _{sol}		Reflow Soldering : 260 °C for 10 sec. Hand Soldering : 350 °C for 3 sec.	

Note:

- 1.The products are sensitive to static electricity and must be carefully taken when handling products.
- 2.LED need sustain bruth push strength greater than 2000g.

Electro-Optical Characteristics (T_{Soldering}=25°C)

Parameter	Symbol	Color	Min.	Typ.	Max.	Unit	Condition
Luminous Intensity	I _v	R6	125	-----	300	mcd	I _F =5mA
		GH	320	-----	500		
		B1	32	-----	80		
Peak Wavelength	λ _p	R6	-----	468	-----	nm	I _F =5mA
		GH	-----	518	-----		
		B1	-----	639	-----		
Dominant Wavelength	λ _d	R6	-----	621	-----	nm	I _F =5mA
		GH	525	-----	535		
		B1	465	-----	475		
Forward Voltage	V _F	R6	1.6	-----	2.2	V	I _F =5mA
		GH	2.5	-----	3.1		
		B1	2.5	-----	3.1		
Viewing Angle	2θ _{1/2}		-----	130	-----	deg	I _F =5mA
Spectrum Radiatic Bandwidth	Δλ		-----	20	-----	nm	I _F =5mA
Reverse Current	I _R		-----	-----	10	μA	V _R =5V

Notes:

1. Tolerance of Luminous Intensity ±15%.
2. Tolerance of Dominant Wavelength: ±1nm
3. Tolerance of Forward Voltage: ± 0.1V.

Bin Code Description

R6: Bin Range of Luminous Intensity

Bin Code	Min.	Max.	Unit	Condition
P	125	200	mcd	I _F =5mA
Q	200	300		

GH: Bin Range of Luminous Intensity

Bin Code	Min.	Max.	Unit	Condition
R	320	500	mcd	I _F =5mA

B1: Bin Range of Luminous Intensity

Bin Code	Min.	Max.	Unit	Condition
M	32	50	mcd	I _F =5mA
N	50	80		

Note:
Tolerance of Luminous Intensity: ±15%.

GH: Bin Range of Dominant Wavelength

Bin Code	Min.	Max.	Unit	Condition
AQ	525	530	nm	I _F =5mA
AR	530	535		

B1: Bin Range of Dominant Wavelength

Bin Code	Min.	Max.	Unit	Condition
AC	465	470	nm	I _F =5mA
AD	470	475		

Note:
Tolerance of Dominant Wavelength: ±1nm

Spectrum Distribution

R5: Spectrum Distribution

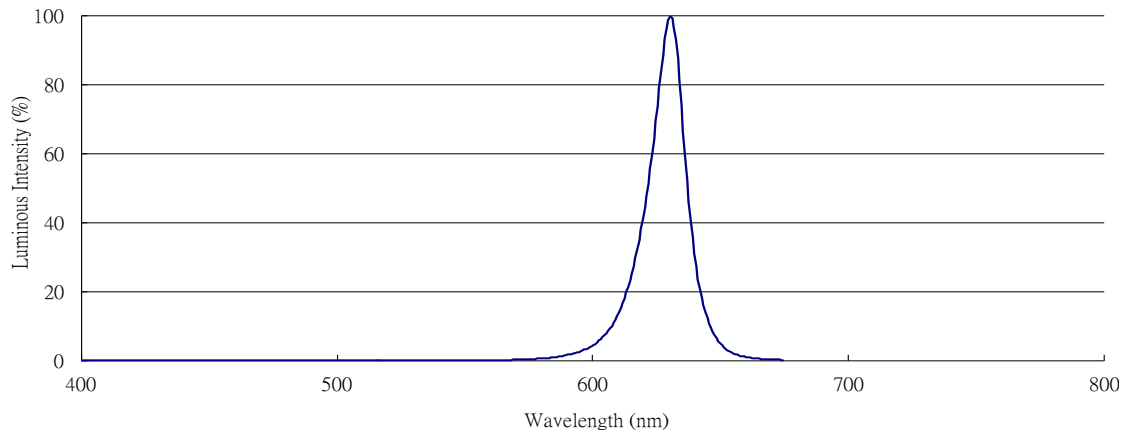

GH: Spectrum Distribution

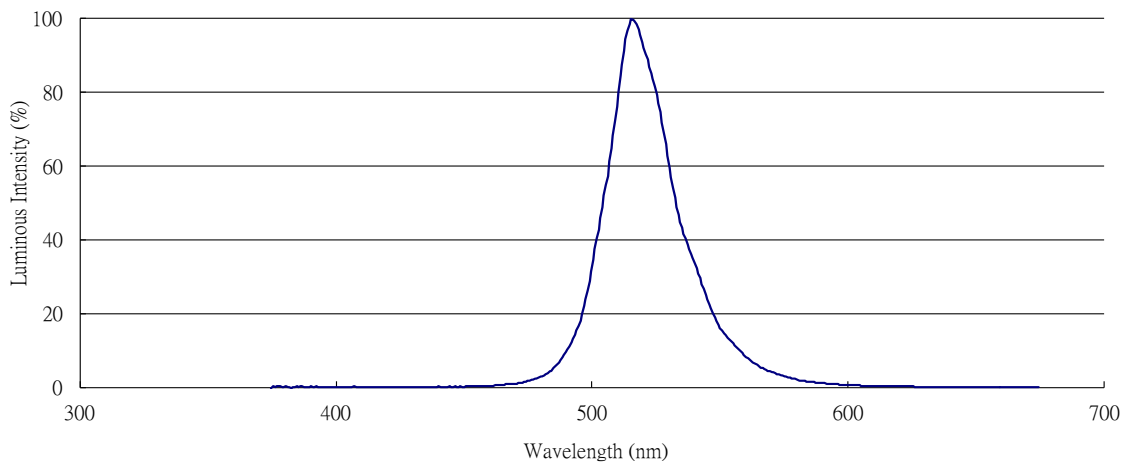

B1: Spectrum Distribution

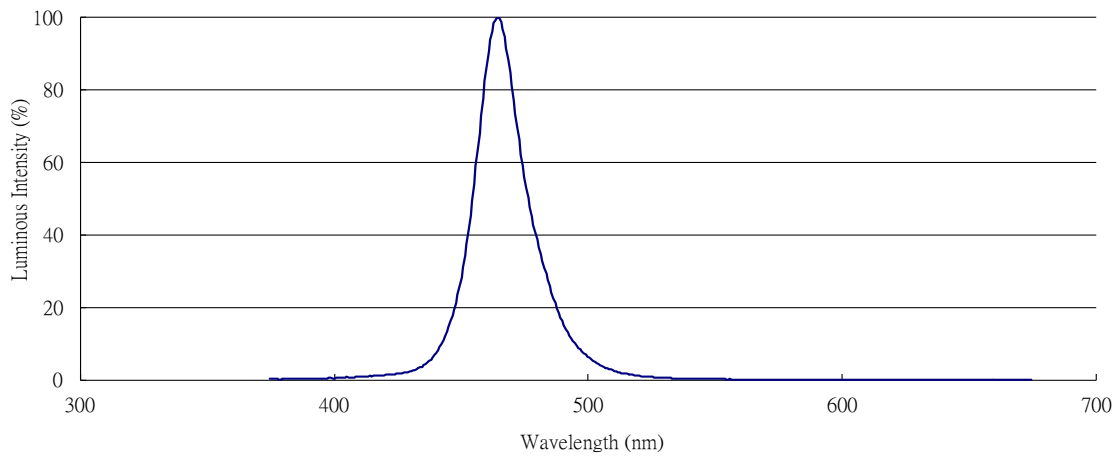

Typical Electro-Optical Characteristics Curve (Chip code: R6)

Fig.1-Forward Voltage Shift vs. Junction Temperature

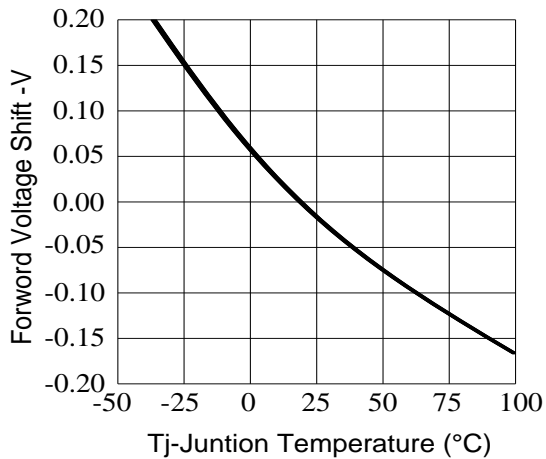

Fig.2-Relative Luminous Intensity vs. Forward Current

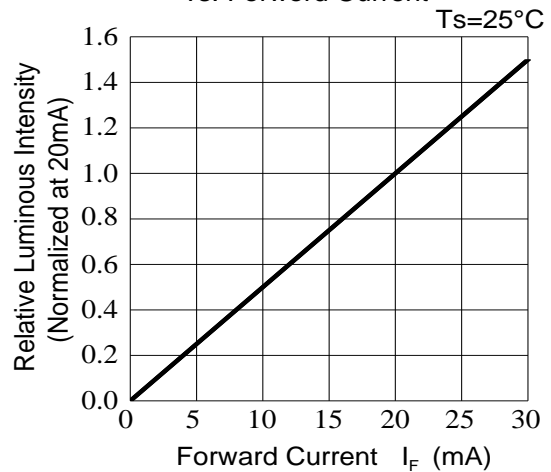

Fig.3-Relative Luminous Intensity vs. Junction Temperature

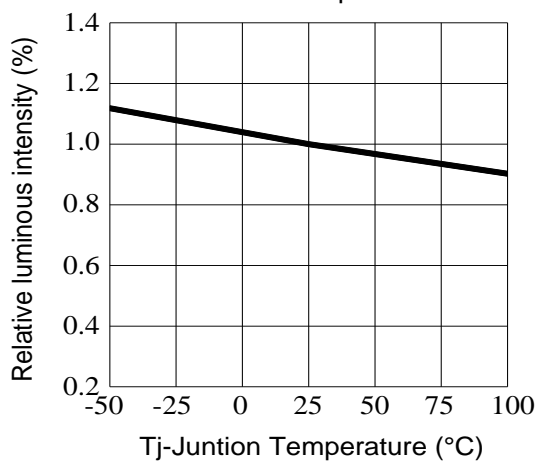

Fig.4-Forward Current vs. Forward Voltage

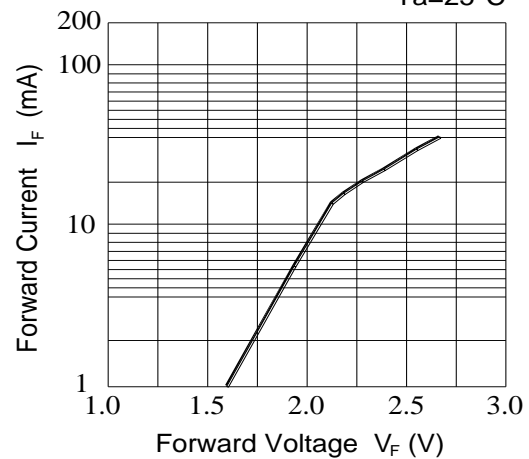

Fig.5-Max. Driving Forward Current vs. Soldering Temperature

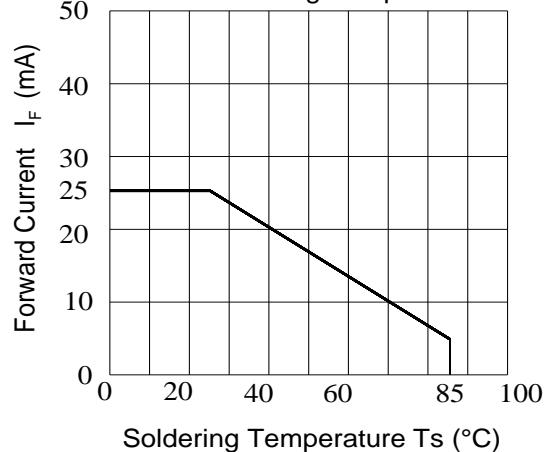
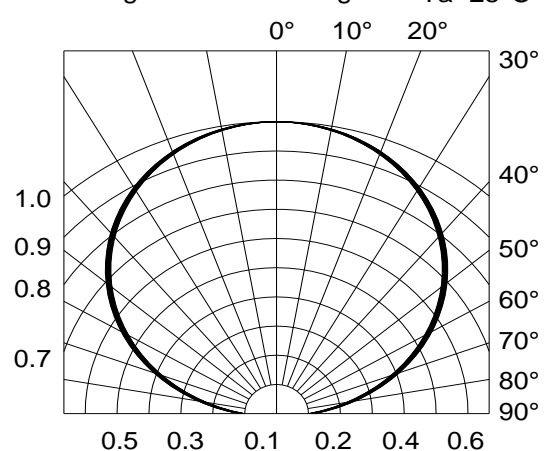

Fig.6-Radiation Diagram



Typical Electro-Optical Characteristics Curve (Chip code: GH/B1)

Fig.1-Forward Voltage Shift vs. Junction Temperature

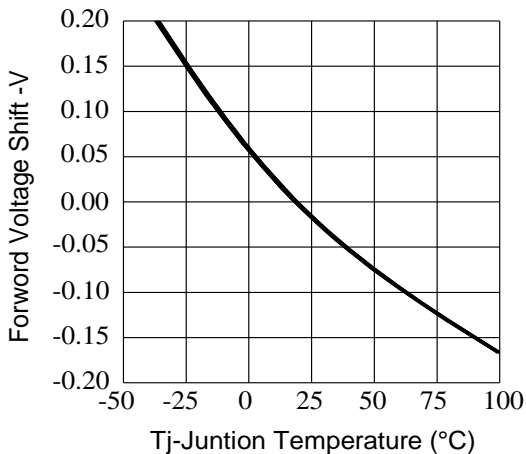

Fig.2-Relative Luminous Intensity vs. Forward Current Ts=25°C

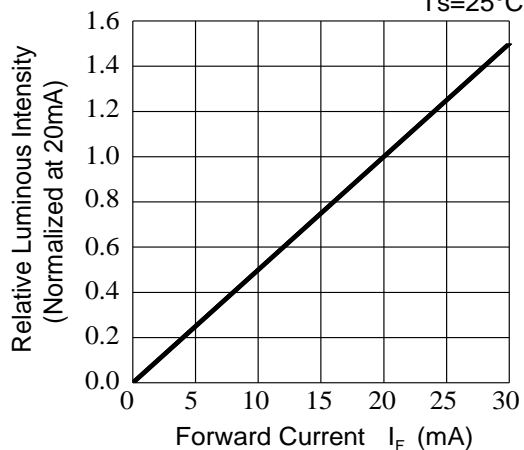

Fig.3-Relative Luminous Intensity vs. Junction Temperature

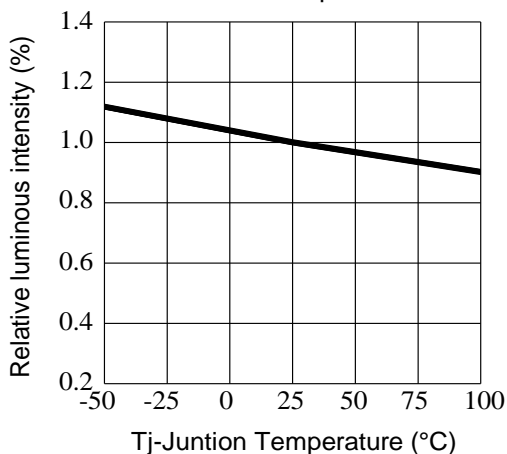

Fig.4-Forward Current vs. Forward Voltage Ta=25°C

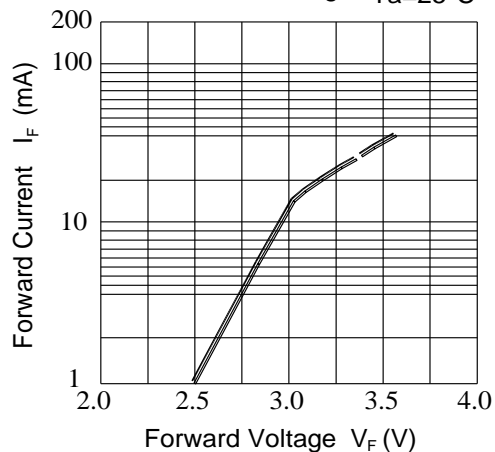

Fig.5-Max. Driving Forward Current vs. Soldering Temperature

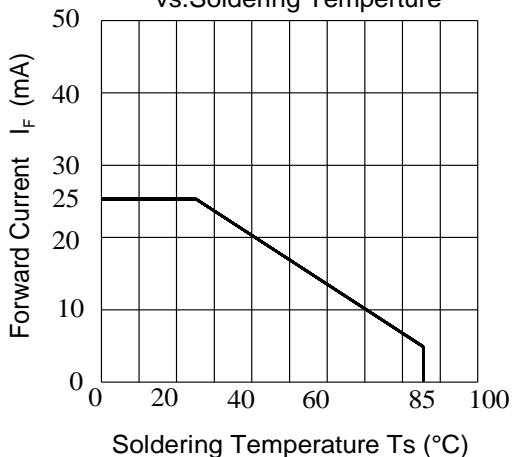
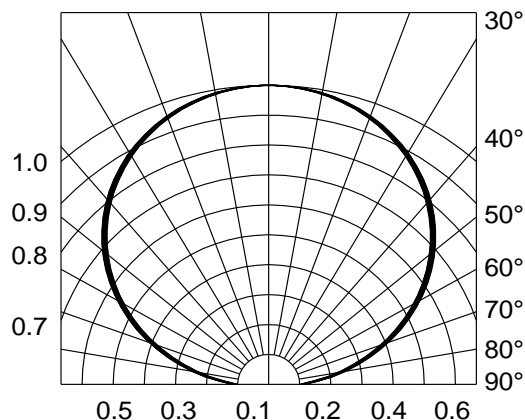
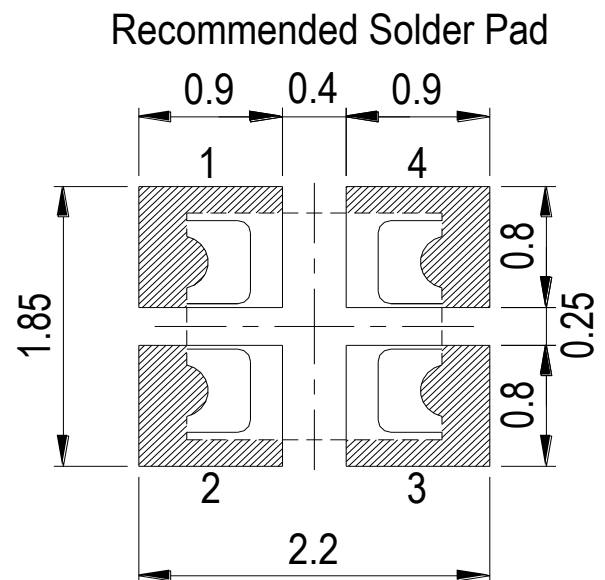
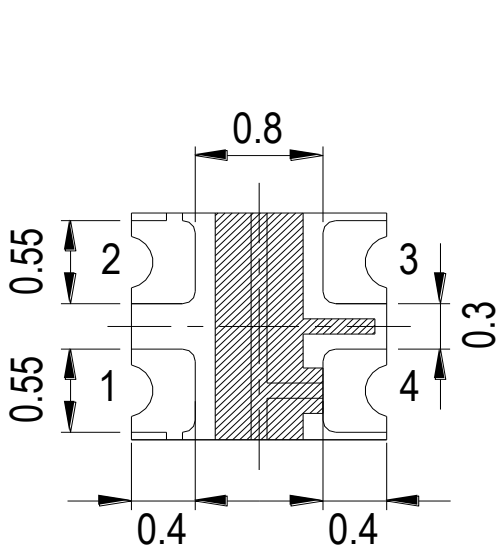
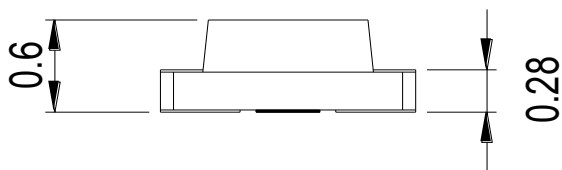
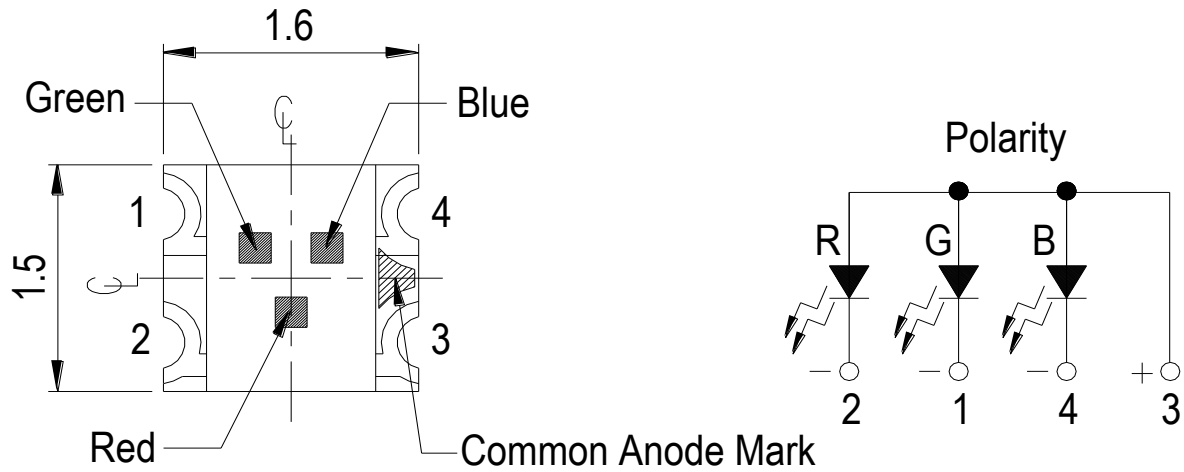

Fig.6-Radiation Diagram Ta=25°C



Package Dimension



Note:
 Tolerance unless mentioned is ± 0.1 mm, Unit = mm.

Moisture Resistant Packing Materials

Label Explanation

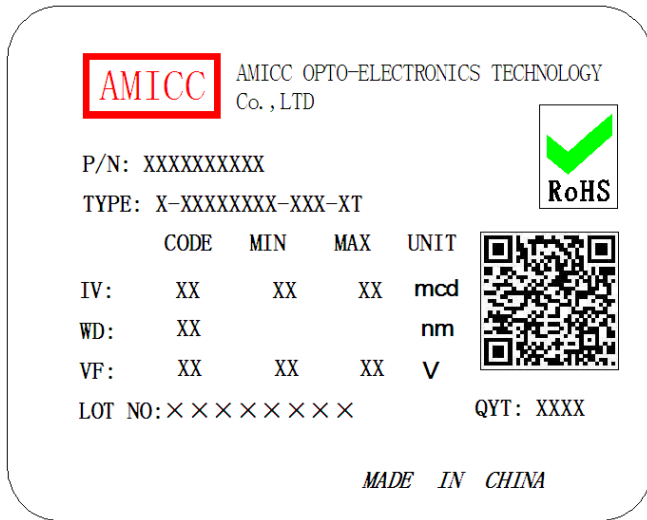

- CPN: Customer's Product Number
- P/N: Product Number
- TYPE :Part NO.
- IV: Luminous Intensity Rank
- WD: Dom. Wavelength Rank
- VF: Forward Voltage Rank
- LOT NO.: Lot Number
- QTY: Packing Quantity

Reel Dimensions

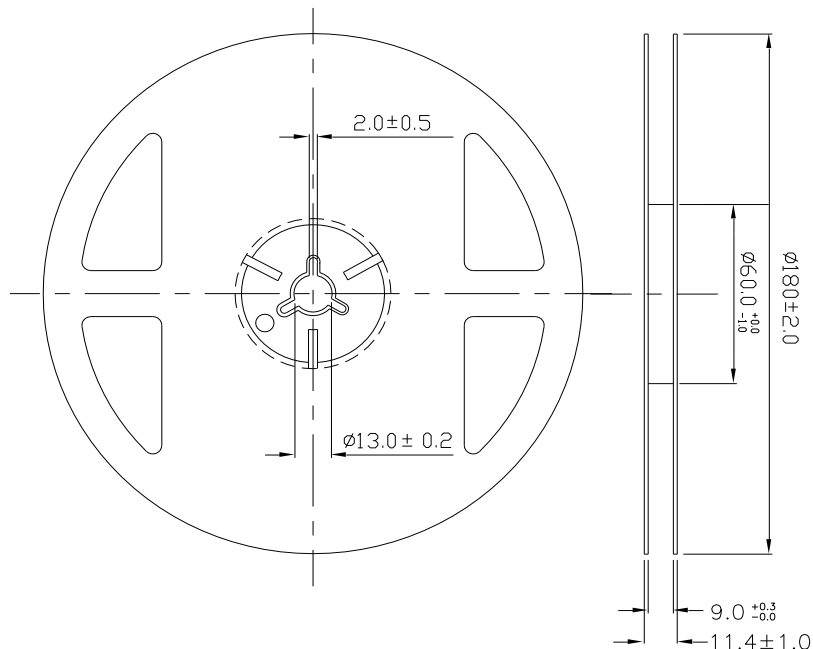

Note:
 Tolerances unless mentioned ± 0.1 mm, Unit = mm.

Carrier Tape Dimensions: Loaded Quantity 2000pcs Per Reel

Progressive direction

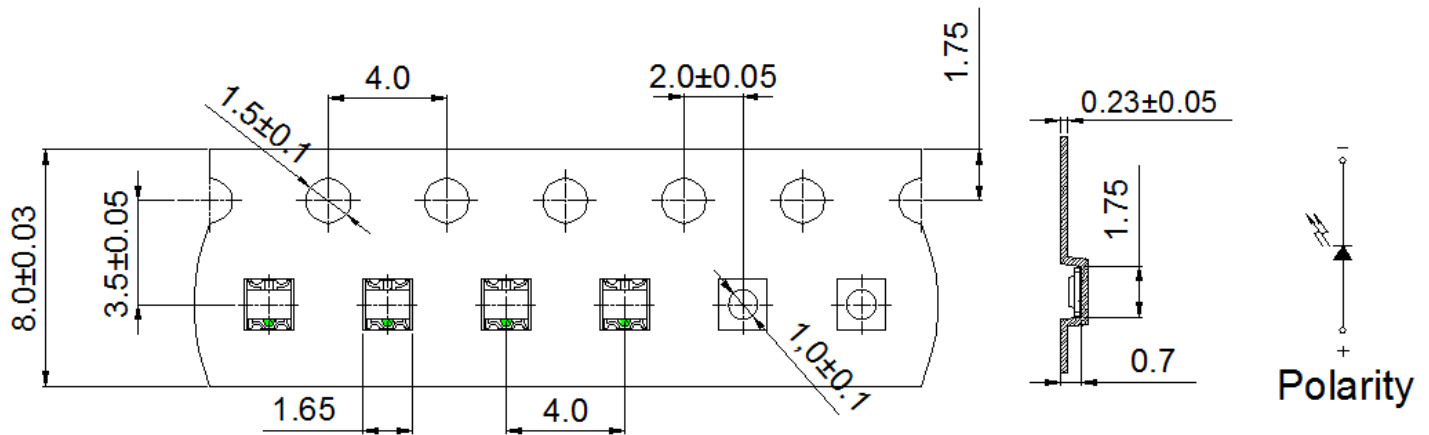

Note:

1. Tolerance unless mentioned is ± 0.1 mm, Unit = mm.
2. Minimum packing amount is 1000pcs per reel.
3. Maximum packing amount is 3000pcs per reel.

Moisture Resistant Packing Process

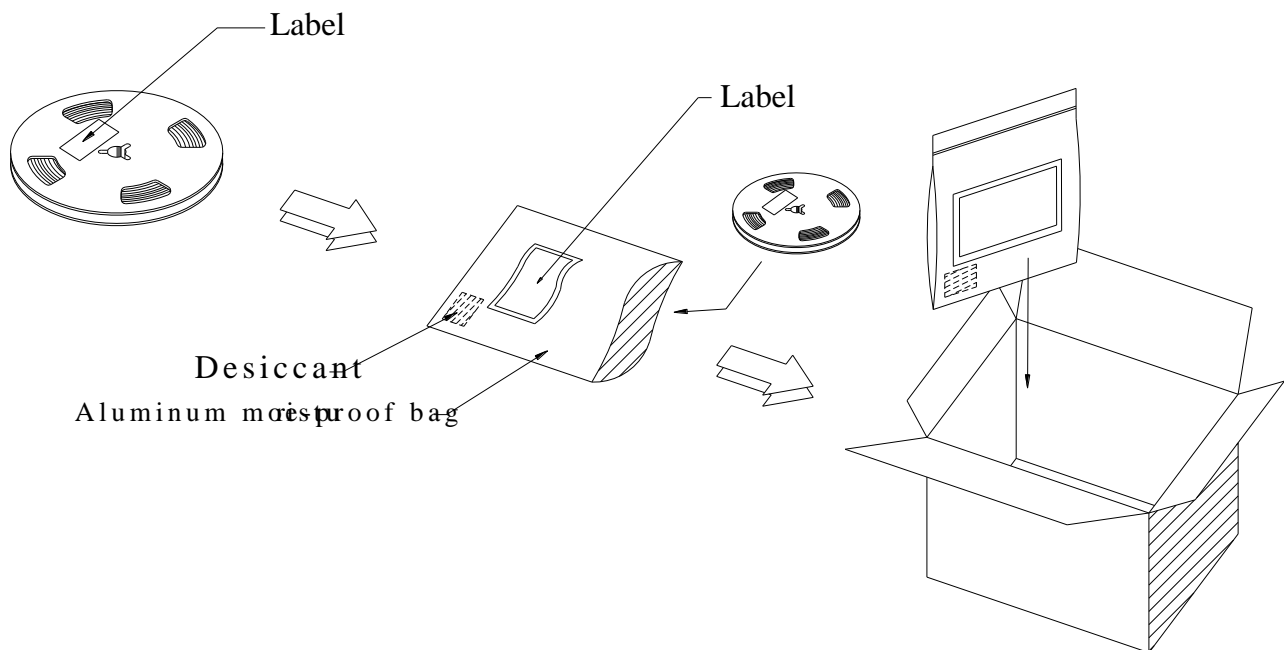

Reliability Test Items and Conditions

The reliability of products shall be satisfied with items listed below.

Confidence level : 90%

LTPD : 10%

No.	Items	Test Condition	Test Hours/Cycles	Sample Size	Ac/Re
1	Reflow Soldering	Temp. : 260°C/10sec.	6 Min.	22 PCS.	0/1
2	Thermal Shock	H : +100°C 5min ∫ 10 sec L : -10°C 5min	300 Cycles	22 PCS.	0/1
3	Temperature Cycle	H : +100°C 15min ∫ 5 min L : -40°C 15min	300 Cycles	22 PCS.	0/1
4	High Temperature/Humidity Reverse Bias	Ta=85°C,85%RH	1000 Hrs.	22 PCS.	0/1
5	Low Temperature Storage	Ta=-40°C	1000 Hrs.	22 PCS.	0/1
6	High Temperature Storage	Ta=100°C	1000 Hrs.	22 PCS.	0/1
7	DC Operation Life	Ta=25°C, I _F = 5mA	1000 Hrs.	22 PCS.	0/1

Precautions for Use

1. Over-current-proof
Customer must apply resistors for protection; otherwise slight voltage shift will cause big current change (Burn out will happen).
2. Storage
 - 2.1 Do not open moisture proof bag before the products are ready to use.
 - 2.2 Before opening the package: The LEDs should be kept at 30°C or less and 90%RH or less.
 - 2.3 After opening the package: The LED's floor life is 1 year under 30°C or less and 60% RH or less. If unused LEDs remain, it should be stored in moisture proof packages.
 - 2.4 If the moisture absorbent material (silica gel) has faded away or the LEDs have exceeded the storage time, baking treatment should be performed using the following conditions.
Baking treatment: 60±5°C for 24 hours.
3. Soldering Condition
 - 3.1 Pb-free solder temperature profile

Date : 2015.11.19

Profile Feature	SMT Component Vendor Spec
Preheat/Soak	
Temperature Min (T _{min})	150 °C
Temperature Max (T _{max})	200 °C
Time (ts) from (T _{min} to T _{max})	need endure 120 seconds
Ramp-up rate (TL to Tp)	need endure 3 °C/second max.
Liquidous temperature (TL)	217 °C
Time (tL) maintained above TL	need endure 90 seconds
Peak package body temperature (Tp)	260 °C
Time (tp)* within 5 °C of the specified classification temperature (Tc), see Figure 1-1 .	need endure 10* seconds
Ramp-down rate (Tp to TL)	need endure 6 °C/second max.
Time 25 °C to peak temperature	need endure 8 minutes max.

Note 1: All temperatures refer to the center of the package, measured on the package body surface that is facing up during assembly reflow (e.g., live-bug). If parts are reflowed in other than the normal live-bug assembly reflow orientation (i.e., dead-bug), Tp shall be within ± 2 °C of the live-bug Tp and still meet the Tc requirements, otherwise, the profile shall be adjusted to achieve the latter. To accurately measure actual peak package body temperatures refer to JEP140 for recommended thermocouple use.

Note 2 : For SMT type component, it need be able to withstand twice times SMT Reflow + once DIP Wave soldering process.

SMT Profile:

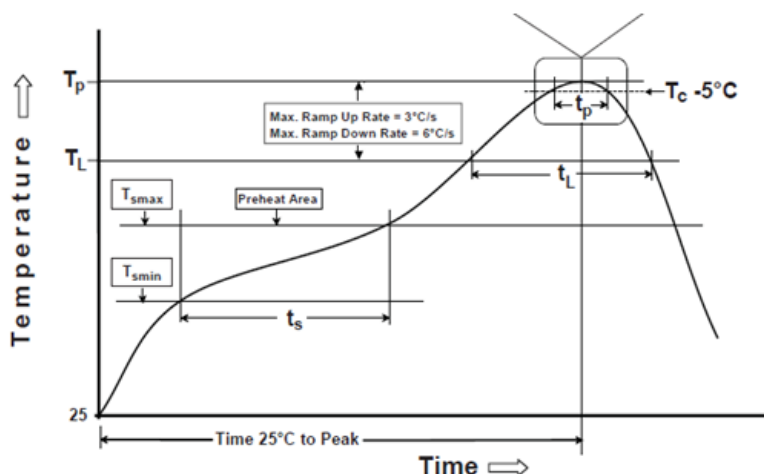

- 3.2 Reflow soldering should not be done more than two times.
- 3.3 When soldering, do not put stress on the LEDs during heating.
- 3.4 After soldering, do not warp the circuit board.

4. Soldering Iron

Each terminal is to go to the tip of soldering iron temperature less than 350°C for 3 seconds within once in less than the soldering iron capacity 25W. Leave two seconds and more intervals, and do soldering of each terminal. Be careful because the damage of the product is often started at the time of the hand solder.

5. Repairing

Repair should not be done after the LEDs have been soldered. When repairing is unavoidable, a double-head soldering iron should be used (as below figure). It should be confirmed beforehand whether the characteristics of the LEDs will or will not be damaged by repairing.

X-ON Electronics

Largest Supplier of Electrical and Electronic Components

Click to view similar products for [Standard LEDs - SMD category](#):

Click to view products by [Amicc manufacturer](#):

Other Similar products are found below :

[LTST-C190KYKT](#) [LTST-C19GD2WT](#) [LTW-170ZDC](#) [LTW-M140SZS40](#) [LTW-M140ZVS](#) [598-8110-100F](#) [598-8610-202F](#) [91-21SUBCS400-A6TR7](#) [QBLP653-IW](#) [QBLP674-IWM-WW](#) [AAAF5060QBFSEEZGS](#) [APT1608QGW](#) [99-213/R6C-AR2T1B/2C](#) [SML-512VWT86A](#) [SML-LX0606SISUGC/A](#) [SML-LXR851SIUPGUBC](#) [LT1ED53A](#) [APFA3010SURKCGKQBDC](#) [APHK1608VGCA](#) [APT2012QGW](#) [LTST-008BGEW](#) [LTW-010DCG](#) [LTW-21TS5](#) [LTW-220DS5](#) [598-8330-117F](#) [65-21SYGC/S530-E3/TR8](#) [CMDA20AYAA7D1S](#) [95-21SURCS530-A3TR10](#) [598-8070-100F](#) [598-8140-100F](#) [598-8610-200F](#) [SML-LXR851SGSIC-TR](#) [SML-512PWT86A](#) [SMF-2432GYC-TR](#) [EASV3015RGYA0](#) [95-21UYC-S530-A5-TR7](#) [LTST-C194TBKT-5A](#) [CLX6E-FKC-CH1M1D1BB7C3D3](#) [SML-LXL0805USBC-TR](#) [SML-LX2835SYSUGCTR](#) [LTW-M670ZVS-M5](#) [APA2106ZGC/G](#) [CLMXB-FKA-CbcfghjnpACBB79463](#) [KPTD-2012LVVBC-D](#) [VFA1101W-5AY3B2-TR](#) [LCB P473-P2R2-3J7L-1-Z](#) [91-21VGC/S556/S68/TR10/S370](#) [LW A67C-S2U1-FK0KM0](#) [LW A673-P1S1-FK0PM0](#) [BL-HE1G033B-TRB](#)