

MODULES 1100

1100 MODULES



IDENTIFICATION VISUELLE MODULES :

Joint d'étanchéité : **ROUGE** = Fond colmaté
 Joint d'étanchéité : **MARRON** = Boîtier **J1**

MODULES - VISUAL IDENTIFICATION :

Sealing grommet : **RED** = Sealed bottom
 Sealing grommet : **BROWN** = Shell **J1**

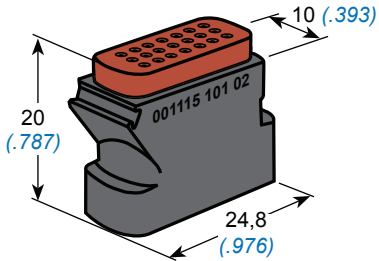

Taille 22
Size 22

21 Contacts
(5 A)

Masse / Weight
8,75 g

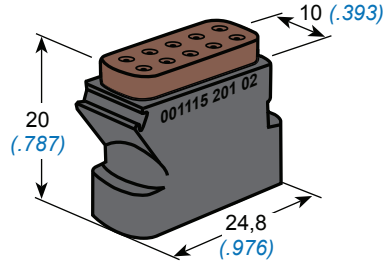

Taille 20
Size 20

10 Contacts
(7,5 A)

Masse / Weight

J1 Rouge Red 6,61 g
Marron Brown 4,85 g

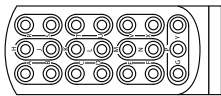

001115 101 02

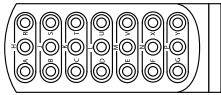

001115 102 02

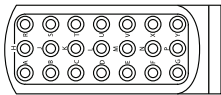

001115 103 02

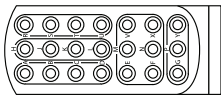

001115 104 02

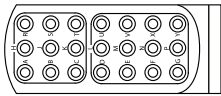

001115 105 02

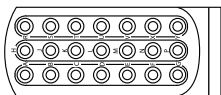

001115 106 02

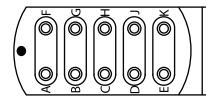

001115 201 02 **J1**

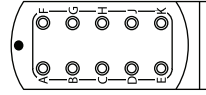

001115 202 02 **J1**

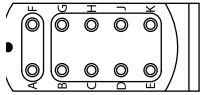

001115 203 02

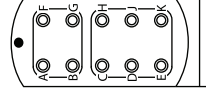

001115 204 02 **J1**

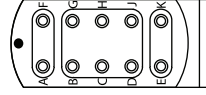

001115 205 02

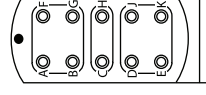

001115 206 02 **J1**

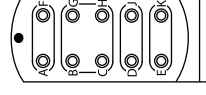

001115 207 02 **J1**

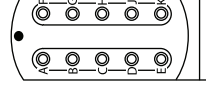

001115 208 02 **J1**

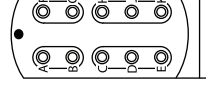

001115 209 02 **J1**

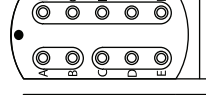

001115 210 02

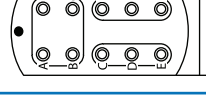

001115 211 02 **J1**

MODULES HETEROGENES MIXED MODULES

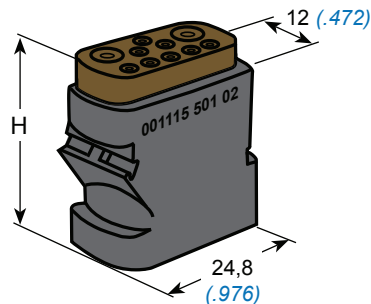

10 Contacts :
2 x 12 + 8 x 20

Masse / Weight
6,8 g

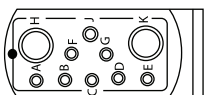

Pas / Pitch : 12 (.472)
H = 22,3 (.877)

001115 501 02 **J1**

18 Contacts ;
2 x 12 + 4 x 16 + 12 x 20

Masse / Weight
25,50 g

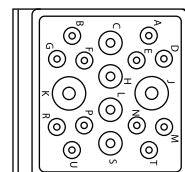

Pas / Pitch : 25 (.984)
H = 23 (.905)

001115 503 02 **J1**

X-ON Electronics

Largest Supplier of Electrical and Electronic Components

Click to view similar products for [Terminal Junction Modules](#) category:

Click to view products by [Amphenol](#) manufacturer:

Other Similar products are found below :

[00175530502](#) [591900-1](#) [M81714/60-12-01](#) [M81714/60-20-06](#) [M81714/65-12-1](#) [YCTD160E01FC108000](#) [YCTJ122E01CC015000](#)
[YHLZG16-2](#) [YHLZR-45](#) [YHLZ16-4](#) [YHLZ16-2](#) [YCTJ420E021C098000](#) [M81714/65-20-2](#) [YHLZ-8](#) [DL60R14-15SN-090-6106](#)
[00111520902](#) [YHLZG16-1](#) [00111520202](#) [TBH120450](#) [00176590602](#) [TJSE20506](#) [MX2000](#) [00172021000](#) [00111820202](#)
[ZPF000000000020152](#) [FMJ11E20-06G](#) [M81714/60-16-02](#) [TJSE20110](#) [00175510702](#) [00176520402](#) [00175520802](#) [TJSE20100](#) [TJT701020](#)
[TJSE20111](#) [00176520502](#) [00175530302](#) [00175112000](#) [00176520202](#) [TJSE22843](#) [00175510802](#) [00175521102](#) [00111521103](#)
[CTD1062E05A-513](#) [M81714/61-0W](#) [TJSE20703](#) [BDX016016-2](#) [BDX016017-2](#) [CTD126E01A-513-LC](#) [TJSE20526](#) [00176590102](#)