

MODULES ÉTANCHES SEALED MODULES

HL 103

IDENTIFICATION VISUELLE MODULES HL103 :

J1 Joint d'étanchéité : **ROUGE** = Fond colmaté

J4 Joint d'étanchéité : **MARRON** = Boîtier

HL 103 avec repérage alphabétique.

HL 104 sans repérage, nous consulter.

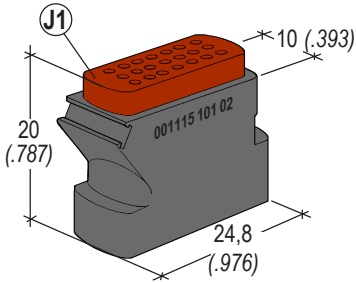

Taille 22
Size 22

21 Contacts
(5 A)

Masse : 8,75 g.
Weight : 0,019 lbs

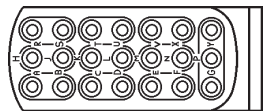

HL 103
001115 101 02

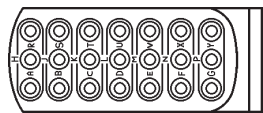

001115 102 02

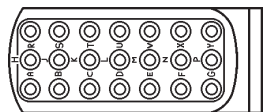

001115 103 02

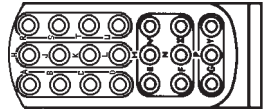

001115 104 02

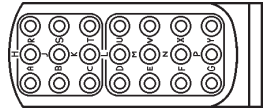

001115 105 02

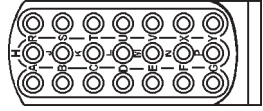

001115 106 02

MODULES HÉTÉROGÈNES MIXED MODULES

10 Contacts :
2 x 12 + 8 x 20

Masse : 10,90 g.
Weight : 0,024 lbs

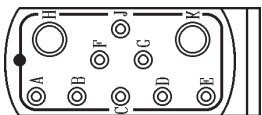

Pas / Pitch : 12 (.472)

H = 25 (.984)

001115 501 02

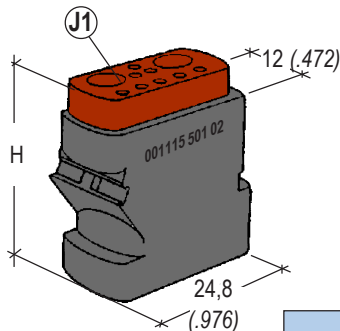

18 Contacts ;
2 x 12 + 4 x 16 + 12 x 20
Masse : 17,50 g.
Weight : 0,038 lbs

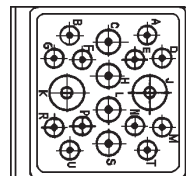

Pas / Pitch : 25 (.984)

H = 23 (.905)

001115 503 02

MODULES HL 103 - VISUAL IDENTIFICATION

J1 Sealing grommet : **RED** = Sealed bottom

J4 Sealing grommet : **MAROON** = Shell

HL 103 with alphabetical identification.

HL 104 without identification, consult to us.

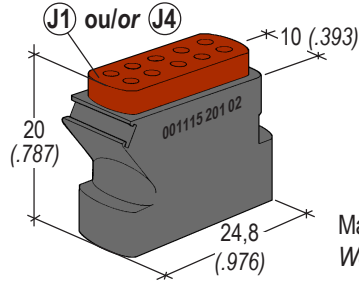

Taille 20
Size 20

10 Contacts
(7,5 A)

Masse : **J1** 6,61 g. - **J4** 4,85 g.
Weight : **J1** 0,014 lbs - **J4** 0,010 lbs

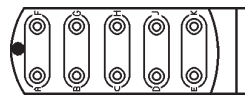

HL 103
001115 201 02 **J1**

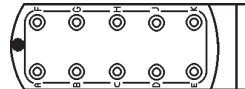

001115 202 02 **J4**

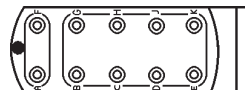

001115 203 02 **J1**

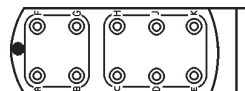

001115 204 02 **J4**

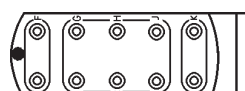

001115 205 02 **J1**

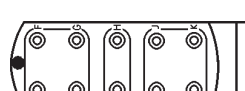

001115 206 02 **J4**

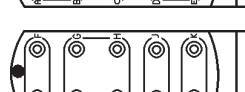

001115 207 02 **J4**

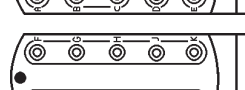

001115 208 02 **J4**

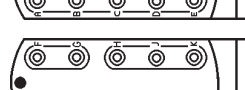

001115 209 02 **J4**

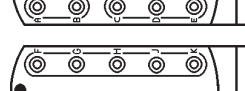

001115 210 02 **J1**

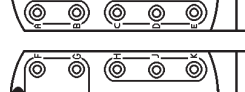

001115 211 02 **J4**

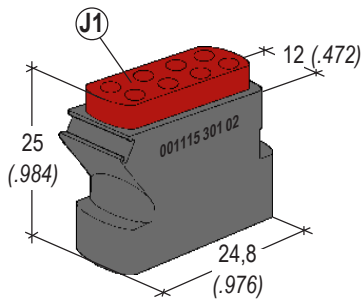

Taille 16
Size 16
8 Contacts
(13 A)
Masse : 12,20 g.
Weight : 0,026 lbs

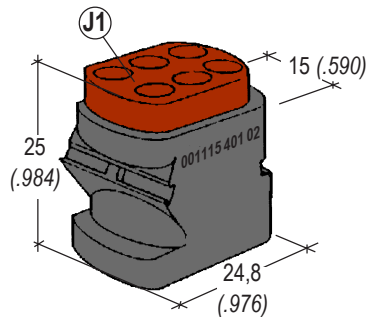

Taille 12
Size 12
6 Contacts
(23 A)
Masse : 15,80 g.
Weight : 0,034 lbs

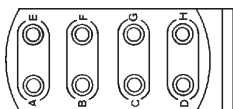

HL 103
001115 301 02

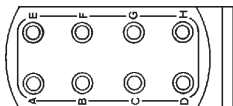

001115 302 02

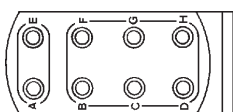

001115 303 02

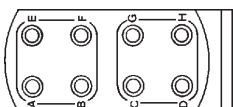

001115 304 02

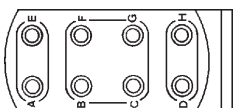

001115 305 02

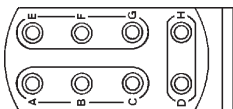

001115 306 02

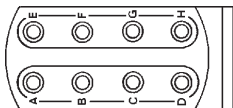

001115 308 02

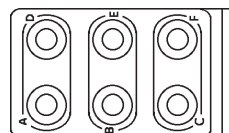

HL 103
001115 401 02

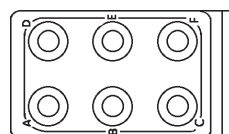

001115 402 02

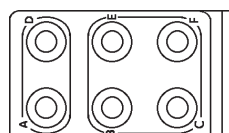

001115 403 02

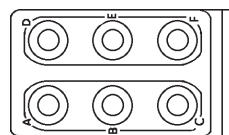

001115 404 02

MODULES DE MASSE à FIXATIONS INDIVIDUELLES

(voir également page 19)

GROUNDING MODULES with INDIVIDUAL MOUNTING BRACKETS

(see page 19 also)

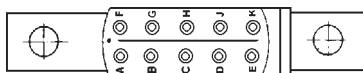
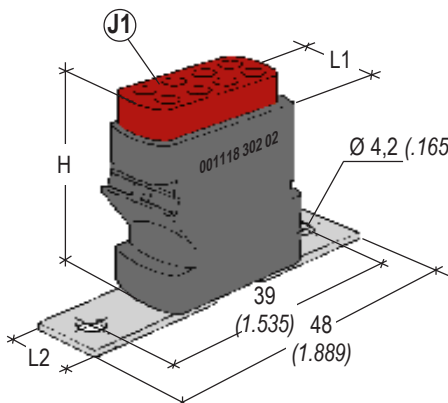

Taille 20
Size 20
10 Contacts
001118 202 02
Masse : 10,5 g.
Weight : 0,023 lbs

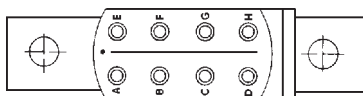

Taille 16
Size 16
8 Contacts
001118 302 02
Masse : 17,5 g.
Weight : 0,038 lbs

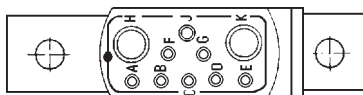

2x12 + 8x20
10 Contacts
001118 501 02
Masse : 16,5 g.
Weight : 0,036 lbs

L1 mm inch	H mm inch	L2 mm inch
10 .939	21,5 .846	10 .939
12 .472	27 1.063	9,6 .378
12 .472	27 1.063	10 .939

MODULES FÛTS À SOUDER

SOLDER CUP MODULES

Taille 22
Size 22

21 Contacts

001115 150 02

Masse : 9,40 g.

Weight : 0,020 lbs

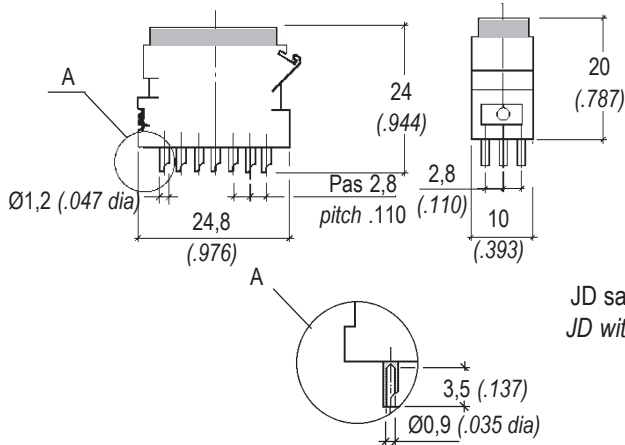

Taille 20
Size 20

10 Contacts

001100 267 02

Masse : 8,60 g.

Weight : 0,0189 lbs

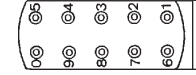
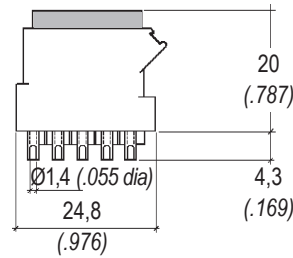

JD sans contact et sans marquage
JD without contact nor identification

001100 264 02

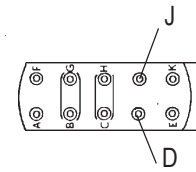

MODULES À PIQUER SUR C.I.

PCB MODULES

Taille 22
Size 22

21 Contacts

001115 151 02

Masse : 9,40 g.

Weight : 0,020 lbs

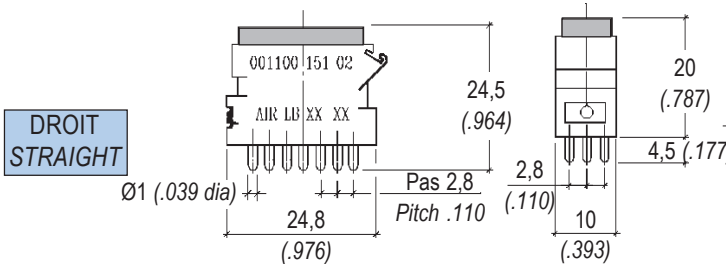

DROIT
STRAIGHT

COUDÉ
RIGHT ANGLED

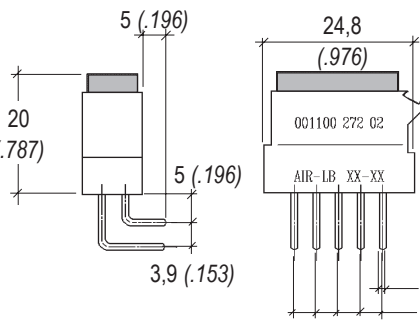

Taille 20
Size 20

10 Contacts

001100 270 02

001100 271 02 (avec A)

Masse : 8,40 g.

Weight : 0,0185 lbs

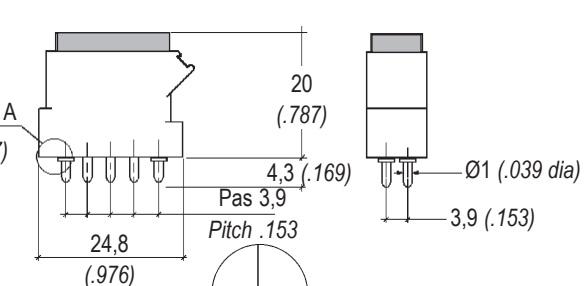

Pieds de lavage
Lifting support

Taille 20
Size 20

10 Contacts

001100 272 02

Masse : 8,40 g.

Weight : 0,0185 lbs

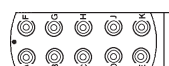

X-ON Electronics

Largest Supplier of Electrical and Electronic Components

Click to view similar products for [Terminal Junction Modules](#) category:

Click to view products by [Amphenol](#) manufacturer:

Other Similar products are found below :

[00175530502](#) [591900-1](#) [M81714/60-12-01](#) [M81714/60-20-06](#) [M81714/65-12-1](#) [YCTD160E01FC108000](#) [YCTJ122E01CC015000](#)
[YHLZG16-2](#) [YHLZR-45](#) [YHLZ16-4](#) [YHLZ16-2](#) [YCTJ420E021C098000](#) [M81714/65-20-2](#) [YHLZ-8](#) [DL60R14-15SN-090-6106](#)
[00111520902](#) [YHLZG16-1](#) [00111520202](#) [TBH120450](#) [00176590602](#) [TJSE20506](#) [MX2000](#) [00172021000](#) [00111820202](#)
[ZPF000000000020152](#) [FMJ11E20-06G](#) [M81714/60-16-02](#) [TJSE20110](#) [00175510702](#) [00176520402](#) [00175520802](#) [TJSE20100](#) [TJT701020](#)
[TJSE20111](#) [00176520502](#) [00175530302](#) [00175112000](#) [00176520202](#) [TJSE22843](#) [00111521103](#) [CTD1062E05A-513](#) [M81714/61-0W](#)
[TJSE20703](#) [BDX016016-2](#) [BDX016017-2](#) [CTD126E01A-513-LC](#) [TJSE20526](#) [00176590102](#) [CTJ920R06N-513](#) [M81714/67-08](#)