

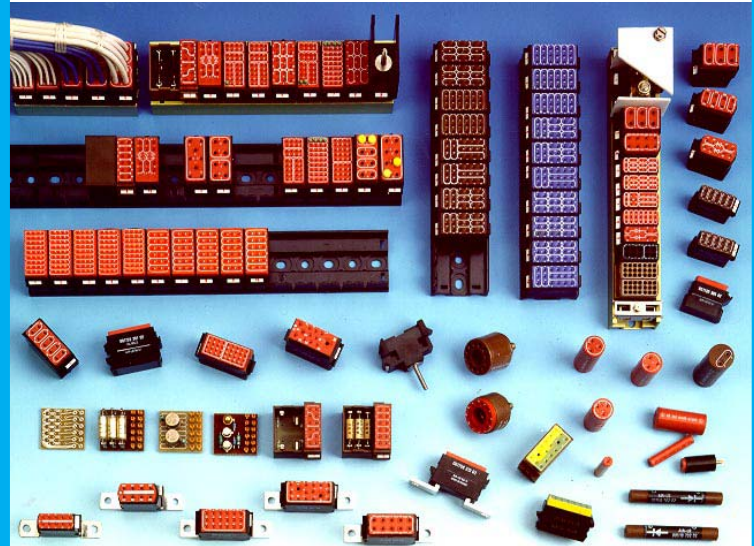

MODULES à JONCTIONS RAPIDES



QUICK CONNECTION MODULES

Edition 11 / 00

Amphenol Air LB

SYSTÈMES DE CONNEXIONS ÉLECTRIQUES ET ÉLECTRONIQUES
ELECTRIC AND ELECTRONIC CONNECTION SYSTEMS

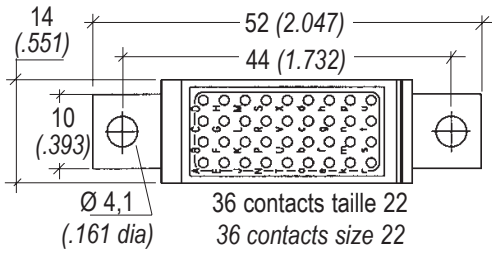

001758 101 02
 A : 21,8 (.858)
 B : 19,5 (.767)
 Masse : 24,0 g.
 Weight : 0,052 lbs

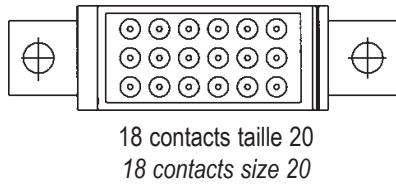
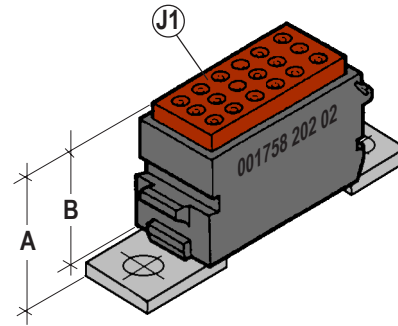

001758 201 02
sans marquage
without markings
 A : 24,8 (.976)
 B : 22,5 (.885)
 Masse : 28,0 g.
 Weight : 0,061 lbs

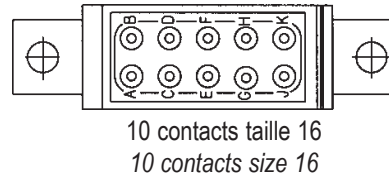

001758 301 02
 A : 26,8 (1.055)
 B : 24,5 (.964)
 Masse : 25,0 g.
 Weight : 0,055 lbs

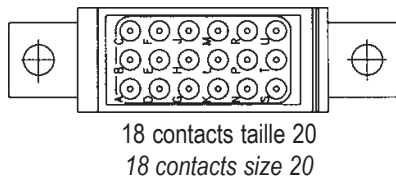

001758 202 02
 A : 24,8 (.976)
 B : 22,5 (.885)
 Masse : 28,0 g.
 Weight : 0,061 lbs

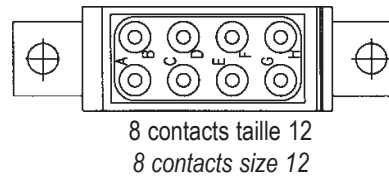

001758 401 02
 A : 26,8 (1.055)
 B : 24,5 (.964)
 Masse : 26,0 g.
 Weight : 0,057 lbs

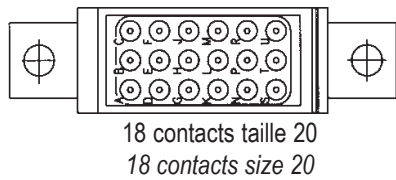

001758 212 02
 A : 24,8 (.976)
 B : 19,5 (.767)
 Masse : 28,0 g.
 Weight : 0,061 lbs

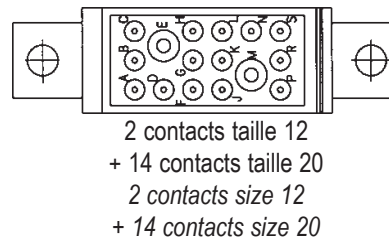

001758 501 02
 A : 26,8 (1.055)
 B : 24,5 (.964)
 Masse : 34,0 g.
 Weight : 0,074 lbs

Modèles dans le type 1100
Model in 1100 typ

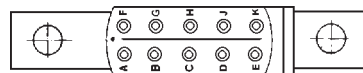
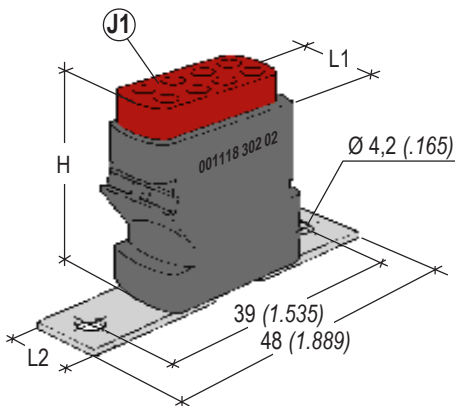

Taille 20
 Size 20
10 Contacts
001118 202 02
 Masse : 10,5 g.
 Weight : 0,023 lbs

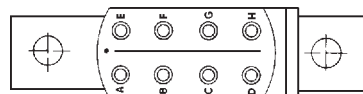

Taille 16
 Size 16
8 Contacts
001118 302 02
 Masse : 17,5 g.
 Weight : 0,038 lbs

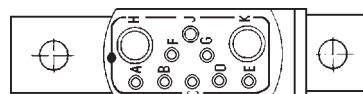

2x12 + 8x20
10 Contacts
001118 501 02
 Masse : 16,5 g.
 Weight : 0,036 lbs

L1 mm inch	H mm inch	L2 mm inch
10 .939	21,5 .846	10 .939
12 .472	27 1.063	9,6 .378
12 .472	27 1.063	10 .939

J2 Joint d'étanchéité **GRIS** = Couleur de la masse

J2 Sealing grommet **GREY** = Grounding colour

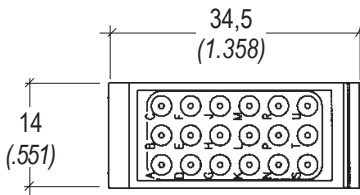

Référence
Part number
001758 220 02
Masse : 17,8 g.
Weight : 0,039 lbs

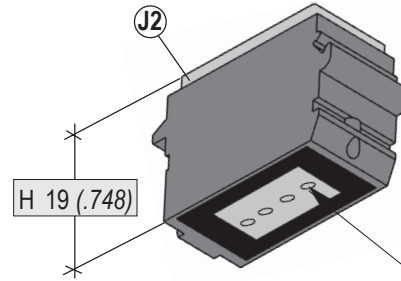

Taille 20
Size 20

18 Contacts
(40 A)

Zone de contact
Contact area

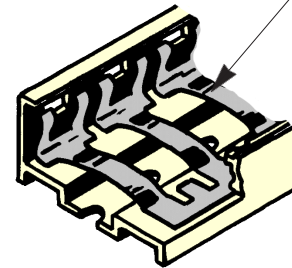

Avec ce module utiliser le rail métallique à revêtement cadmié bichromaté
Use the metallic cadmium bichromate plated rail with this module.

Référence : 001751 1** 07
Part number

Nombre de modules
Number of modules
01 - 02 - 03 - etc...

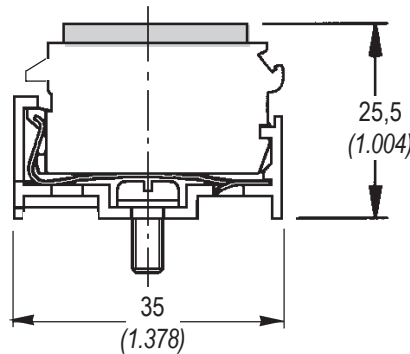

PRECAUTIONS D'EMPLOI

Monter le module en vis à vis de la fixation.

Ne pas juxtaposer ce type de module, laisser au minimum 3 pas de module.

MOUNTING ADVICE

Insert the module facing the module locking device.

Do not mount module side by side, leave at least a space for three modules between two grounding modules.

X-ON Electronics

Largest Supplier of Electrical and Electronic Components

Click to view similar products for [Terminal Junction Modules](#) category:

Click to view products by [Amphenol](#) manufacturer:

Other Similar products are found below :

[00175530502](#) [591900-1](#) [M81714/60-12-01](#) [M81714/60-20-06](#) [M81714/65-12-1](#) [YCTD160E01FC108000](#) [YCTJ122E01CC015000](#)
[YHLZG16-2](#) [YHLZR-45](#) [YHLZ16-4](#) [YHLZ16-2](#) [YCTJ420E021C098000](#) [M81714/65-20-2](#) [YHLZ-8](#) [DL60R14-15SN-090-6106](#)
[00111520902](#) [YHLZG16-1](#) [00111520202](#) [TBH120450](#) [00176590602](#) [TJSE20506](#) [MX2000](#) [00172021000](#) [00111820202](#)
[ZPF000000000020152](#) [FMJ11E20-06G](#) [M81714/60-16-02](#) [TJSE20110](#) [00175510702](#) [00176520402](#) [00175520802](#) [TJSE20100](#) [TJT701020](#)
[TJSE20111](#) [00176520502](#) [00175530302](#) [00175112000](#) [00176520202](#) [TJSE22843](#) [00175510802](#) [00175521102](#) [00111521103](#)
[CTD1062E05A-513](#) [M81714/61-0W](#) [TJSE20703](#) [BDX016016-2](#) [BDX016017-2](#) [CTD126E01A-513-LC](#) [TJSE20526](#) [00176590102](#)