

NOTES:

- MATERIALS OF CONSTRUCTION:  
 HOUSING, BODY, BARREL, HEX NUT & FERRULE = BRASS (Q0-B-626), NICKEL PLATED (.000100 MIN THICK)  
 WASHER = BRASS (Q0-B-613), NICKEL PLATED (.000100 MIN THICK)  
 CONTACT PIN = PHOSPHOR BRONZE, GOLD PLATED (.000003 MIN THICK)  
 INSULATORS (2) = DELRIN, NATURAL  
 GASKET = SILICONE RUBBER, COLOR RED
- CRIMPED FERRULE = HEX CRIMP SIZE .255  
 CRIMPED CONTACT PIN = HEX CRIMP SIZE .068
- MAX PANEL THICKNESS = 3.5mm [.138]

31-2264-RFX		REVISIONS			
DRAWING NO.	REV	DESCRIPTION	DATE	ECO	APPR
THIRD ANGLE PROJ.	--	RELEASE TO MFG.			
	B	SEE SHEET 1	10/19/00	43559	CPM
	C	SEE SHEET 1	1/16/02	43940	CPM

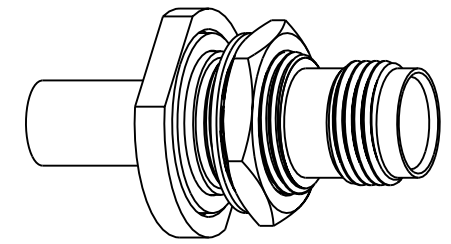

SCALE 1.500

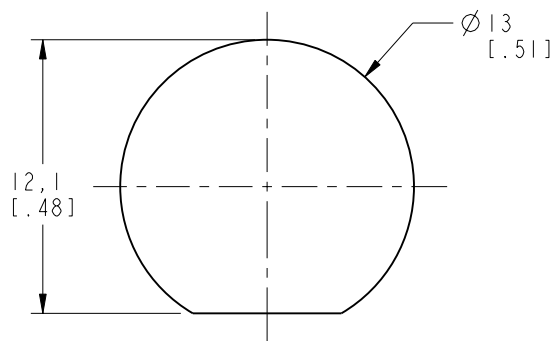
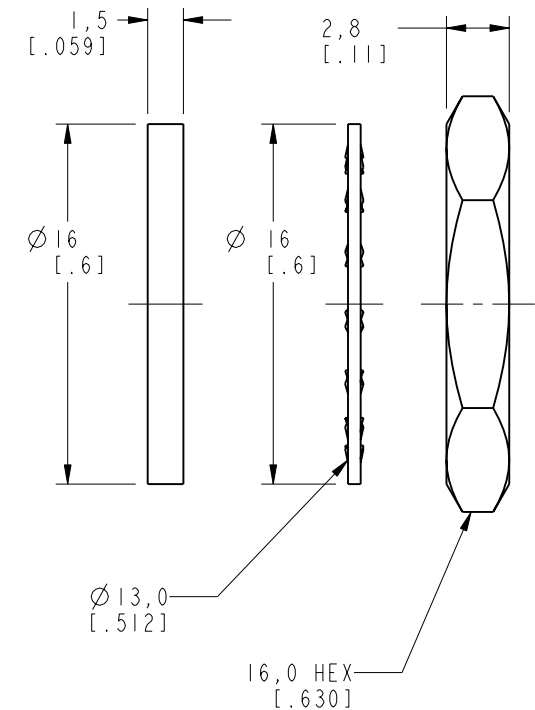
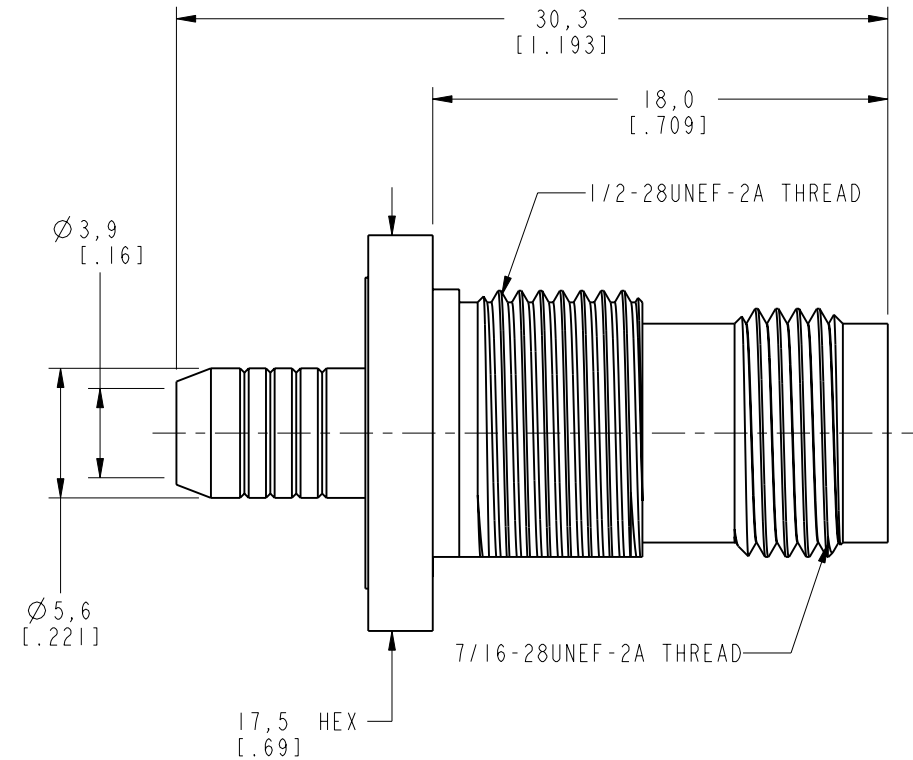
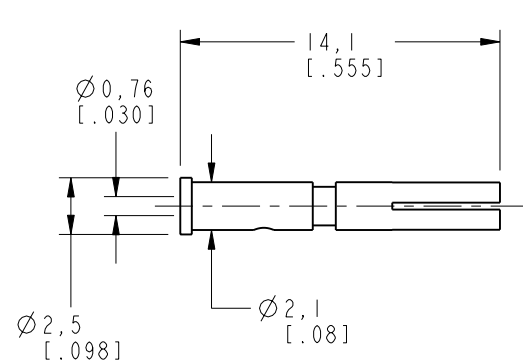
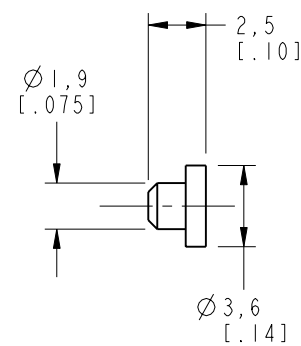
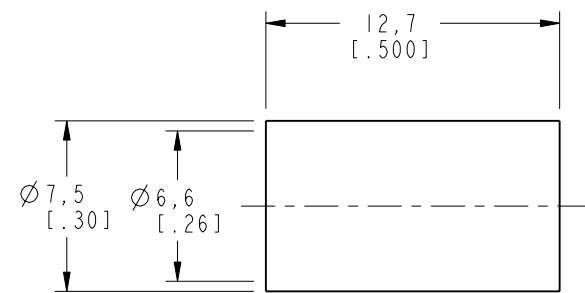

RECOMMENDED MOUNTING HOLE DIMENSIONS  
SCALE 3.000

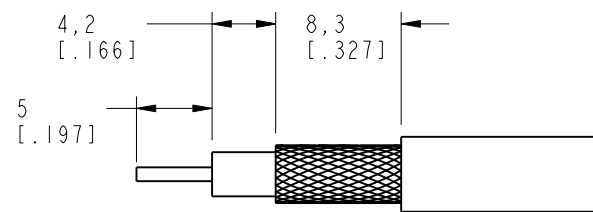

RECOMMENDED CABLE STRIPPING DIMENSIONS  
SCALE 2.000

**CUSTOMER OUTLINE DRAWING**  
ALL OTHER SHEETS ARE FOR INTERNAL USE ONLY

UNLESS OTHERWISE SPECIFIED, DIMENSIONS ARE IN INCHES AND TOLERANCES ARE: 0.5 - 6mm ±0.2mm    6 - 30mm ±0.4mm    30 - 120mm ±0.6mm	MATERIAL	DRAWN C. McGRATH	DATE 05-Oct-00	TITLE TNC BULKHEAD JACK CRIMP, CRIMP FOR RG-59, -62 CABLE 50 OHM	<b>Amphenol</b> Amphenol Corporation Communication and Network Products Division Danbury, CT U.S.A. 06810 SCALE: 3.0:1    SHEET 2 OF 2	
	NOTICE - These drawings, specifications, or other data (1) are, and remain the property of Amphenol Corp. (2) must be returned upon request; and (3) are confidential and not to be disclosed to any person other than those to whom they are given by Amphenol Corp. The furnishing of these drawings, specifications, or other data by Amphenol Corp., or to any other person to anyone for any purpose is not to be regarded by implication or otherwise in any manner licensing, granting rights or permitting such holder or any other person to manufacture, use or sell any product, process or design, patented or otherwise, that may in any way be related to or disclosed by said drawings, specifications, or other data.	REFERENCE GEN# ASSYF23_TNC	ENGINEER O. BARTHELME	DATE 05-Oct-00		APPROVED O. BARTHELME
		CAD FILE I:\TNC\31-2264-RFX	CODE ID 74868	DWG SIZE B	DRAWING NO. 31-2264-RFX	REV C

## X-ON Electronics

Largest Supplier of Electrical and Electronic Components

*Click to view similar products for [RF Connectors / Coaxial Connectors](#) category:*

*Click to view products by [Amphenol](#) manufacturer:*

Other Similar products are found below :

[8915-1511-000](#) [89674-0827](#) [6001-7071-019](#) [6002-7051-003](#) [6002-7551-202](#) [6059674-1](#) [619550-1](#) [630059-000](#) [M39030/3-01N](#) [M3933/25-36N](#) [6500-7071-046](#) [6769](#) [CX050L2AQ](#) [7002-1542-011](#) [7004-1512-000](#) [7009-1511-004](#) [7010-1511-000](#) [7029-1511-060](#) [7101-1541-010](#) [7101-1571-002](#) [7105-1521-002](#) [7145-1521-002](#) [7203-1571-003](#) [7209-1511-011](#) [7210-1511-015](#) [7210-1511-019](#) [73137-5015](#) [73216-2241](#) [7325-1512-000](#) [73404-2300](#) [7405-1521-005](#) [7405-1521-802](#) [7406-1521-005](#) [8527](#) [8547](#) [FS11V](#) [8808-1511-001](#) [9049-9513-000](#) [9074-9513-000](#) [9101-9573-002](#) [910A205F](#) [9130-9573-002](#) [PL11SC-026](#) [PL375-33](#) [PL40-5](#) [PL71-9](#) [PL74C-221](#) [PL75MC-217](#) [PL803-7](#) [980-8666-005](#)