

MINITEK® UNSHROUDED VERTICAL HEADERS

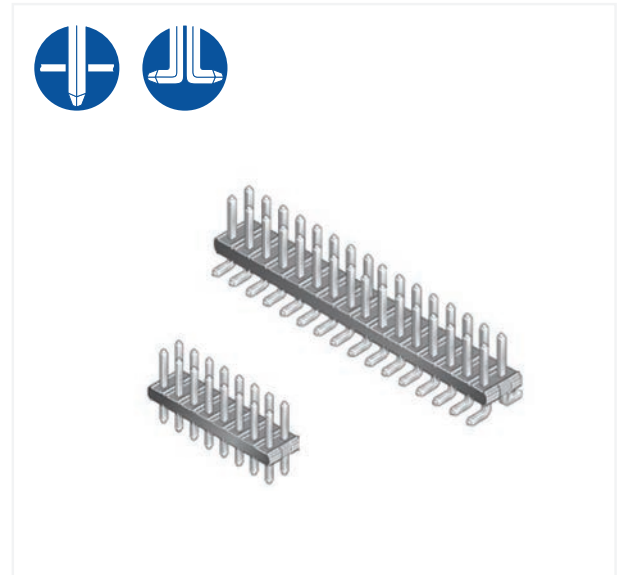



TECHNICAL INFORMATION

MATERIALS

- Housing: High temperature, black thermoplastic
- Flammability rating: UL94V-0
- Pin: Phosphor-bronze
- Plating: Gold/GXT over 1.27µm (50µin.) nickel

ELECTRICAL PERFORMANCE

- Current rating: 3A continuous
- Insulation resistance: $1 \times 10^5 \text{M}\Omega$ min.
- Contact resistance: 25mΩ max.
- Dielectric withstanding voltage: 650V
- Voltage rating: 200V



ENVIRONMENTAL PERFORMANCE

- Operating temperature range: -55°C to +125°C

MECHANICAL PERFORMANCE

- Mating cycles (durability): 100

SPECIFICATIONS

-  File no. E66906
-  File no. LR46923
- Product drawing: 57102 or 57202
- Product specification: DPS-12-011 and GS-12-163
- Tape and reel packaging data: TA-884

APPROVALS AND CERTIFICATIONS

- This product is RoHS compatible according to the European Union Directive 2002/95/IEC

PACKAGING

- Standard: TMT in tubes (04 to 06 pos. packed in box)
- SMT in Tape-and-reel
- Optional: SMT in tubes

PROCESSING INFORMATION

- Compatible with wave, vapor-phase, and IR reflow soldering processes

TYPICAL APPLICATIONS

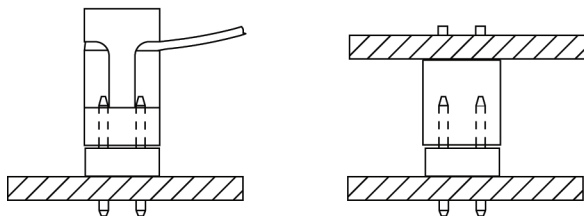
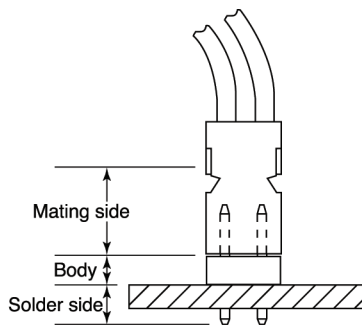

PART NUMBERS

CORE RANGE

57202 — G 52 — XXALF

XX = 02, 03, 04, 05, 06, 08, 10

5	7	LEAD	0	2	PLATING	PIN STYLE	POSITIONS PER ROW	PACKAGING	LF
Through Mount (TMT)		1				Through Mount (TMT)		02 to 25	
Surface Mount (SMT)		2				Surface Mount (SMT)		02 to 25	
0.76µm (30µin.), gold/GXT on mating area, 2-6µm (79-237µin.) tin on solder side				G					
Gold flash on mating area, 2-6µm (79-237µin.) tin on solder side				F					
						Tube without cap (TMT)		U	
						Tape-and-reel with cap (SMT)		A	

Surface Mount		Through Mount			
Mating Side (mm)	Pin Style	Mating Side (mm)	Solder Side (mm)	OAL (mm)	Pin Style
2.00	51	4.00	2.50	8.00	06
4.00	52	4.00	3.00	8.50	08

PRODUCT

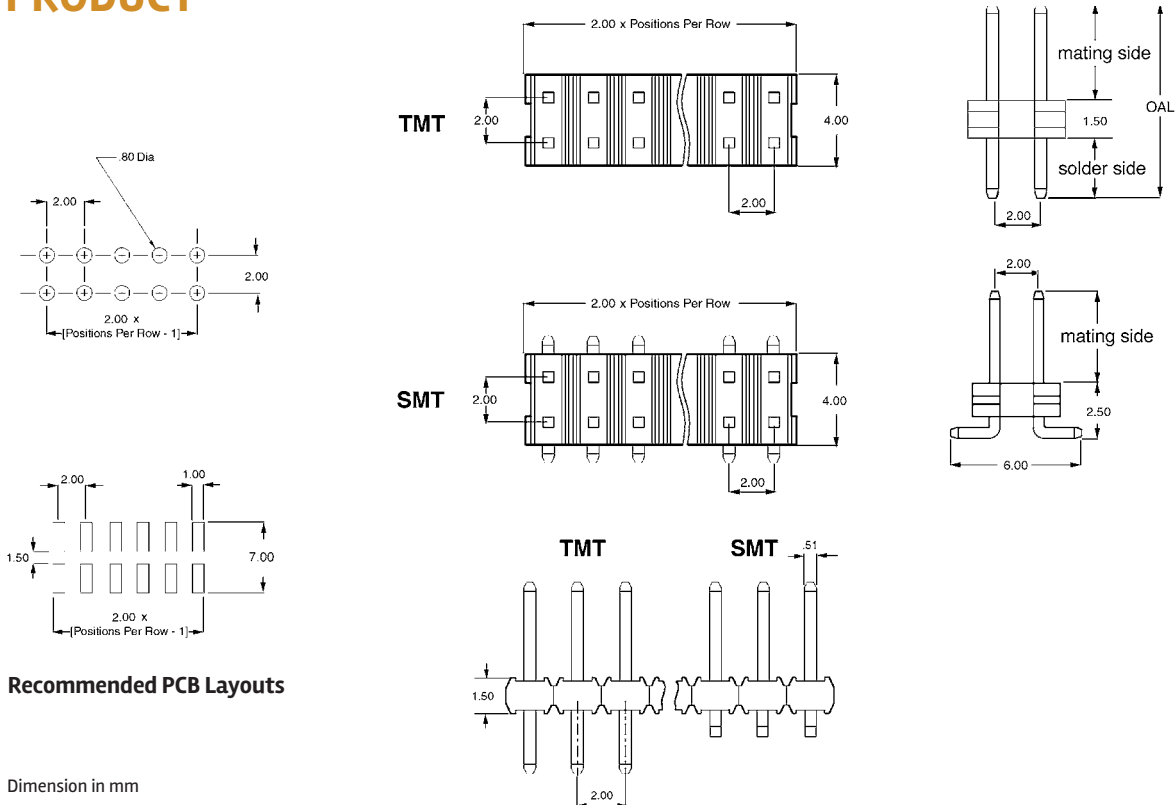



MINITEK[®] UNSHROUDED RIGHT ANGLE HEADERS



FEATURES & BENEFITS

- High temperature plastic
- Selective plating



MINITEK® UNSHROUDED RIGHT ANGLE HEADERS

TECHNICAL INFORMATION

MATERIALS

- Housing: High temperature, black thermoplastic
- Flammability rating: UL94V-0
- Pin: Phosphor-bronze
- Plating: Gold/GXT over 1.27µm (50µin.) nickel

ELECTRICAL PERFORMANCE

- Current rating: 3A continuous
- Insulation resistance: $1 \times 10^5 \text{M}\Omega$ min.
- Contact resistance: 25mΩ max.
- Dielectric withstanding voltage: 650V
- Voltage rating: 200V

ENVIRONMENTAL

- Operating temperature range: -55°C to +125°C



MECHANICAL PERFORMANCE

- Mating cycles (durability): 100

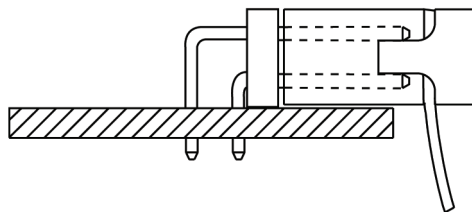
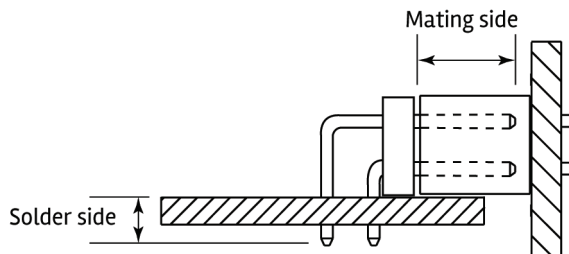
TYPICAL APPLICATIONS



SPECIFICATIONS

-  File no. E66906
-  File no. LR46923
- Product drawing: 98423
- Product specification: DPS-12-011 and GS-12-163

APPROVALS AND CERTIFICATIONS

- This product is RoHS compatible according to the European Union Directive 2002/95/IEC

PACKAGING

- Tubes (04 to 06 pos. packed in box)

PROCESSING INFORMATION

- Compatible with wave, vapor-phase, and IR reflow soldering processes

**MINITEK® UNSHROUDED
RIGHT ANGLE HEADERS**



PART NUMBERS



0.76µm (30µin.), gold/GXT on mating area, 2-6µm (79-237µin.) tin on solder side	G
Gold flash on mating area, 2-6µm (79-237µin.) tin on solder side	F

02 to 25

PRODUCT

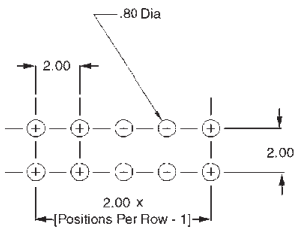

Recommended PCB Layouts

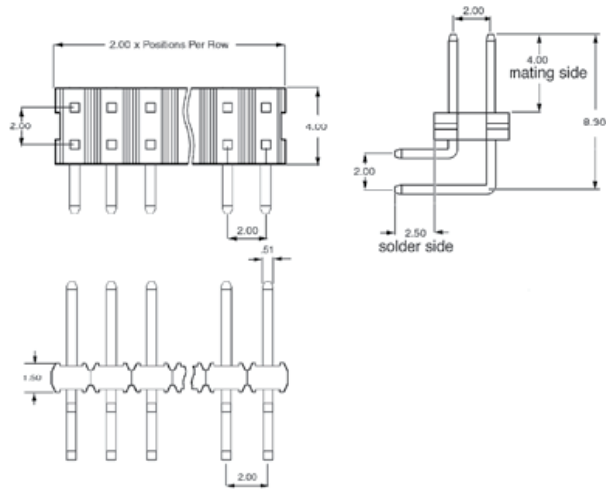

Dimension in mm

MINITEK® UNSHROUDED HEADERS, PIN-IN-PASTE

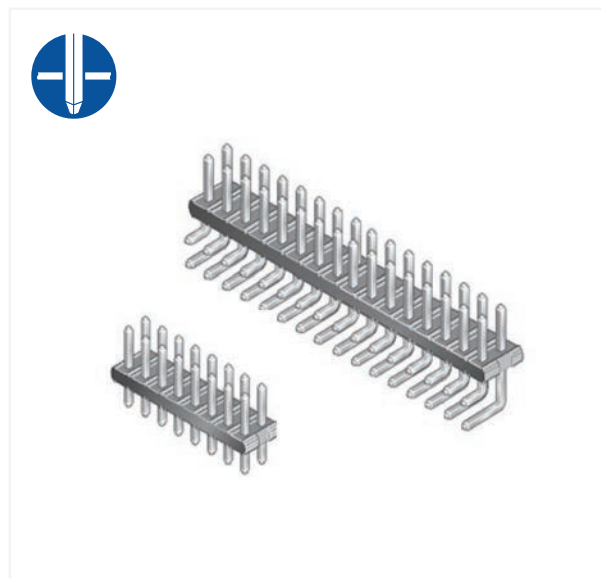

MINITEK® UNSHROUDED HEADERS, PIN-IN-PASTE

TECHNICAL INFORMATION

MATERIALS

- Housing: High temperature, black thermoplastic
- Flammability rating: UL94V-0
- Pin: Phosphor-bronze
- Plating: Gold/GXT over 1.27µm (50µin.) nickel

ELECTRICAL PERFORMANCE

- Current rating: 3A continuous
- Insulation resistance: $1 \times 10^5 \text{M}\Omega$ min
- Contact resistance: 25Ω max.
- Dielectric withstanding voltage: 650V
- Voltage rating: 200V



ENVIRONMENTAL

- Operating temperature range: -55°C to +125°C

MECHANICAL PERFORMANCE

- Mating cycles (durability): 100

SPECIFICATIONS

-  File no. E66906
-  File no. LR46923
- Product drawing: By 8-digit base part number
- Product specification: DPS-12-011 and GS-12-163
- Application specification: TA-895
- Reflow profile: TA-842

PACKAGING

- Tubes (04 to 06 pos. packed in box)
- Tape-on-reel with pick up cap

PROCESSING INFORMATION

- Compatible with wave, vapor-phase, and IR reflow soldering processes

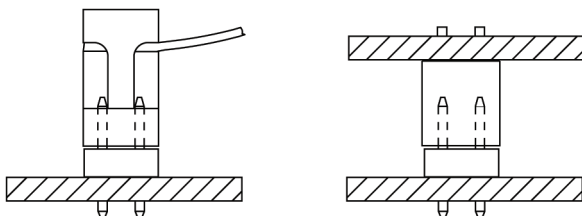
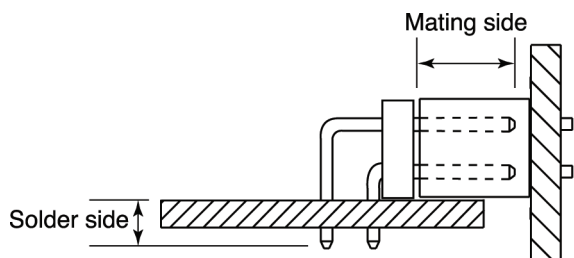

PART NUMBERS

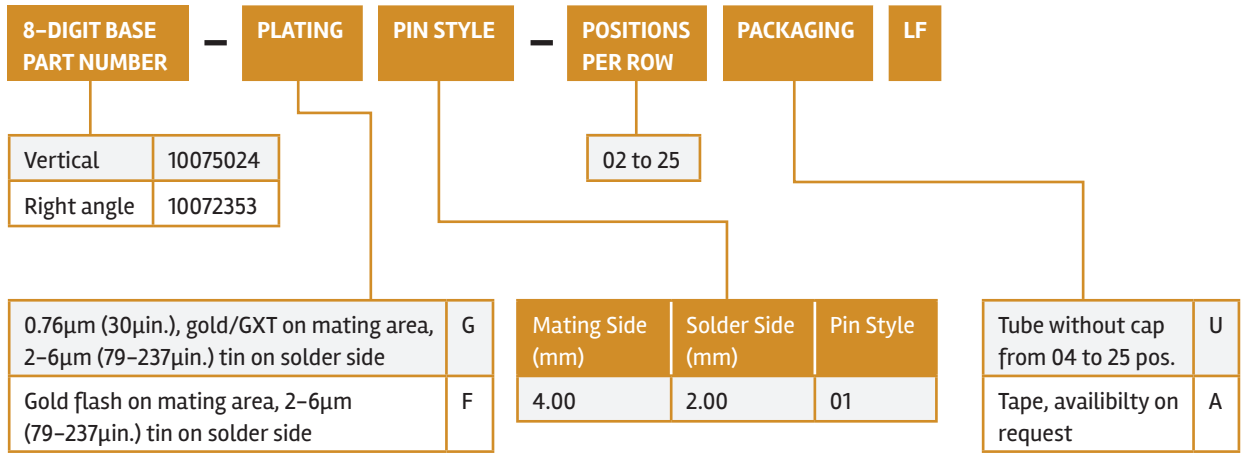

PRODUCT

10075024 Vertical

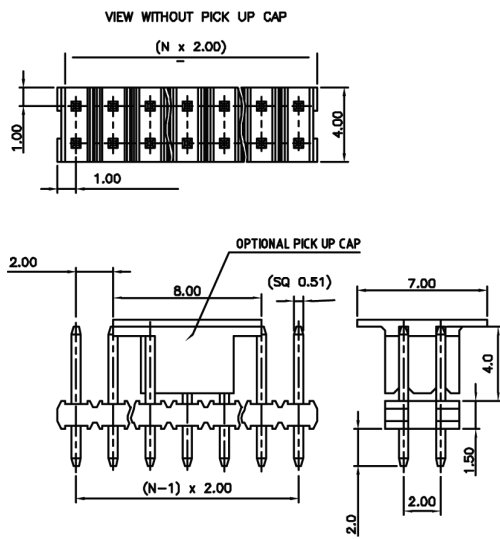

10072353 Right angle

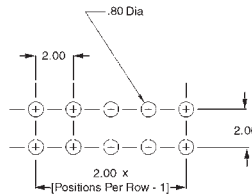
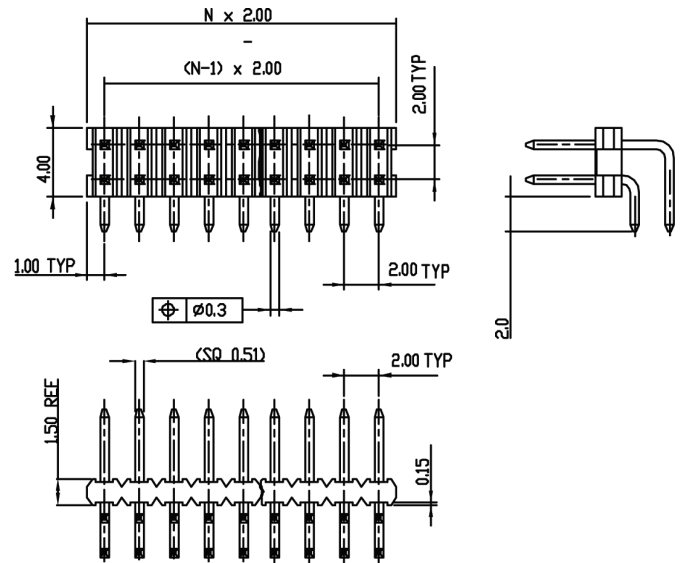

Recommended PCB Layouts

Dimension in mm

MINITEK[®] UNSHROUDED STACKING HEADERS

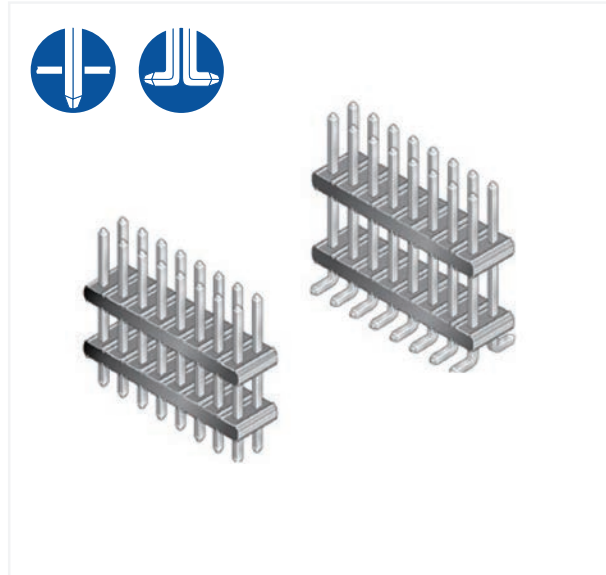

FEATURES & BENEFITS

- Wide variety of stack heights in 0.13mm increments
- Custom sizes to meet your specific design requirements

TECHNICAL INFORMATION

MATERIALS

- Housing: High temperature, black thermoplastic
- Flammability rating: UL94V-0
- Pin: Phosphor-bronze
- Plating: Gold over 1.27µm (50µin.) nickel

ELECTRICAL PERFORMANCE

- Current rating: 2A continuous
- Insulation resistance: 1 x 10⁵MΩ min.
- Contact resistance: 25Ωm max.
- Dielectric withstanding voltage: 650V
- Voltage rating: 200V



ENVIRONMENTAL

- Operating temperature range: -55°C to +125°C

MECHANICAL PERFORMANCE

- Mating cycles (durability): 100

SPECIFICATIONS

-  File no. E66906
-  File no. LR46923
- Product drawing: 59112, 59132, or 59202
- Product specification: DPS-12-011

APPROVALS AND CERTIFICATIONS

- This product is RoHS compatible according to the European Union Directive 2002/95/IEC

PACKAGING

- Standard: In bags

PROCESSING INFORMATION

- Compatible with wave, vapor-phase, and IR reflow soldering processes

TYPICAL APPLICATIONS

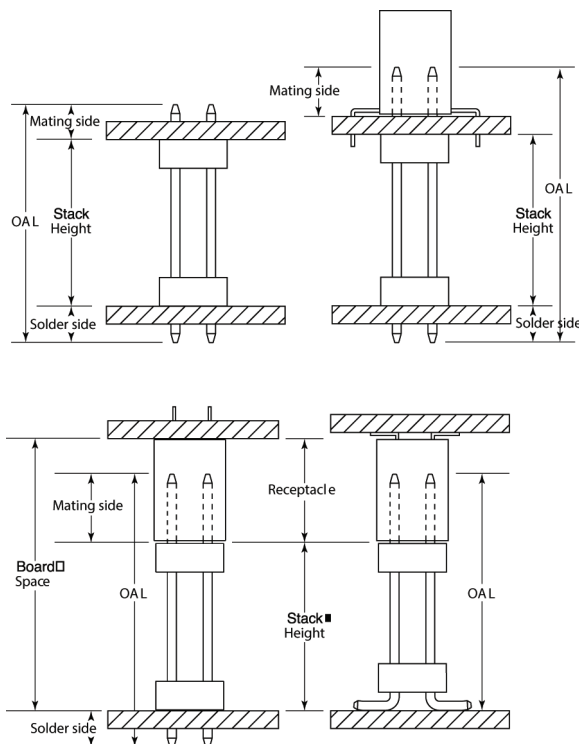

MINITEK® UNSHROUDED STACKING HEADERS

PART NUMBERS

Compile your own part number using custom dimensions (Please allow for initial setup on our system)

5	9	LEAD	SOLDER SIDE OPTION	2	PLATING	PIN STYLE	POSITIONS PER ROW	STACK HEIGHT	LF
---	---	------	--------------------	---	---------	-----------	-------------------	--------------	----

Through Mount (TMT)	1
Surface Mount (SMT)	2

2.50	1
3.00	3
SMT	0

0.76µm (30µin.) gold on mating side, tin on solder side	T
---------------------------------------------------------	---

Overall Length (OAL)		Pin Style
(TMT) mm	(SMT) mm	
8.20	6.53	22
9.55	7.87	24
10.19	8.51	26
11.79	10.11	28
13.54	11.86	30
14.10	12.42	32
15.60	13.92	34
17.09	15.42	36
19.08	17.40	38
21.08	19.41	40

TMT	02 to 25
SMT	02 to 25

XXX = mm
Specify mm (e.g., 037 = 03.7mm) in 0.1mm increments

PRODUCT

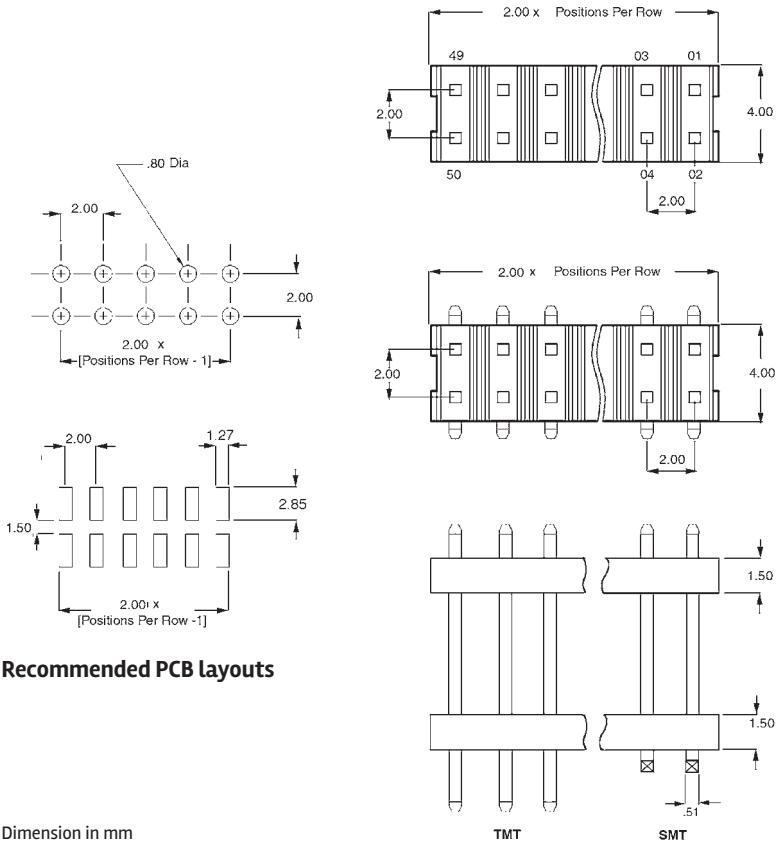

The board spacing is the stack height of this header, plus the height of the receptacle (see application drawings on opposite page)

Recommended PCB layouts

Dimension in mm

For more information, please contact: Communications@fci.com or visit us at www.fci.com

Disclaimer
Please note that the above information is subject to change without notice.

MINITEK® VERTICAL RECEPTACLES

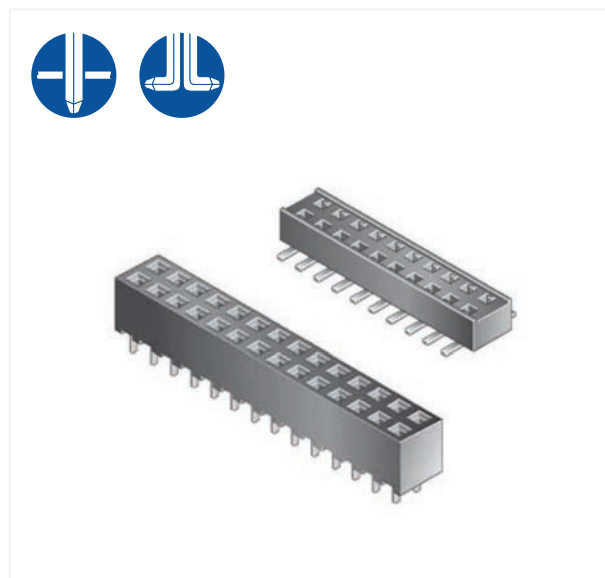

FEATURES & BENEFITS

- Two housing heights: 2.30mm, 4.50mm
- Dual-beam contact design for highly reliable electrical performances



TECHNICAL INFORMATION

MATERIALS

- Housing: High temperature, black thermoplastic
- Flammability rating: UL94V-0
- Contact: Phosphor-bronze
 - Beryllium-copper-63453
- Plating: Gold over 1.27µm (50µin.) nickel

ELECTRICAL PERFORMANCE

- Current rating: 2A continuous
- Insulation resistance: 1 x 10⁵MΩ min.
- Contact resistance:
 - 20mΩ
 - 25mΩ – 63453
- Dielectric withstanding voltage: 650V
- Voltage rating: 200V



ENVIRONMENTAL

- Operating temperature range: -55°C to +125°C

MECHANICAL PERFORMANCE

- Mating cycles (durability):
 - 25
 - 100 – 63453
- Contact retention to housing:
 - 2.20 N (227gf) min.
 - 4.90 N (500gf) min. – 63453
- Insertion force per contact:
 - 1.80 N (184gf) max.
 - 1.95 N (200gf) – 63453
- Withdrawal force per contact:
 - 0.20 N (20gf) min.

SPECIFICATIONS

-  File no. E66906
-  File no. LR46923
- Product drawing: By 5-digit base part number
- Product specification:
 - GS-12-008
 - DPS-12-011 – for 63453

APPROVALS AND CERTIFICATIONS

- This product is RoHS compatible according to the European Union Directive 2002/95/IEC

PACKAGING

- Standard:
 - TMT in tubes
 - SMT in tape-and-reel
- Optional: Tubes (SMT)

PROCESSING INFORMATION

- Compatible with wave, vapor-phase, and IR reflow soldering processes

INSERTION DEPTH

- 4.50mm height: 3.00mm min. to 4.30mm max. [provides .381mm wipe]
- 2.30mm height – top entry: 1.30mm min. to 2.20mm max. [provides .381mm wipe]
- 2.30mm height – bottom entry: 1.40mm min. to 2.20mm max. [provides .381mm wipe] plus board thickness

TYPICAL APPLICATIONS

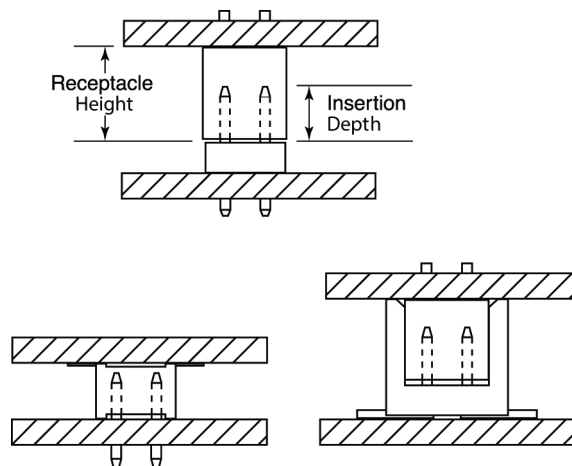

PART NUMBERS

CORE RANGE

55510 — 1XXTRLF

XX = 04, 06, 08, 10, 12, 16, 20

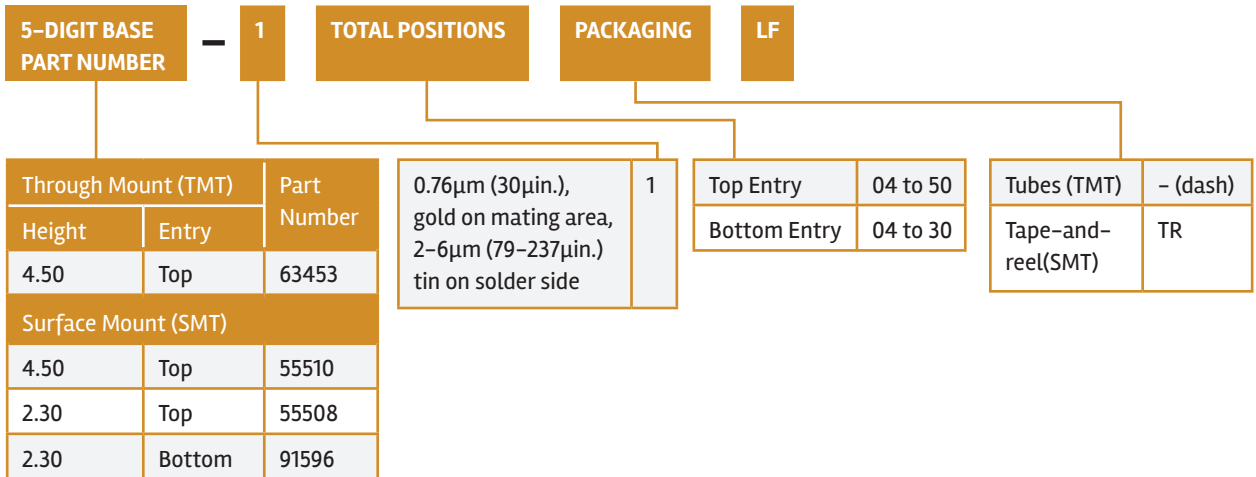

PRODUCT

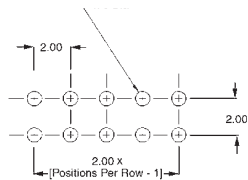

Top Entry

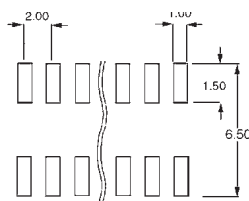

Bottom Entry

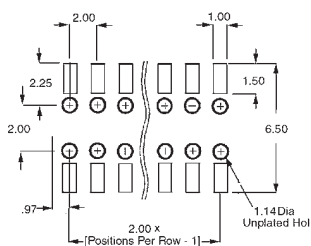

Recommended PCB layouts

Dimension in mm

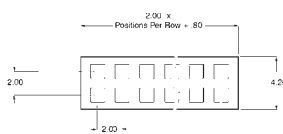

P/N 63453

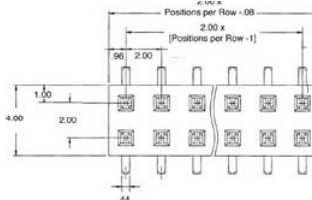
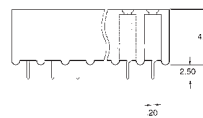

P/N 55510

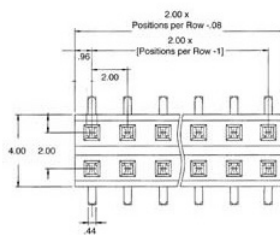
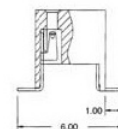

P/N 55508

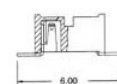

For more information,
please contact: Communications@fci.com
or visit us at www.fci.com

Disclaimer
Please note that the above information is subject to change without notice.



MINITEK[®] SHUNTS

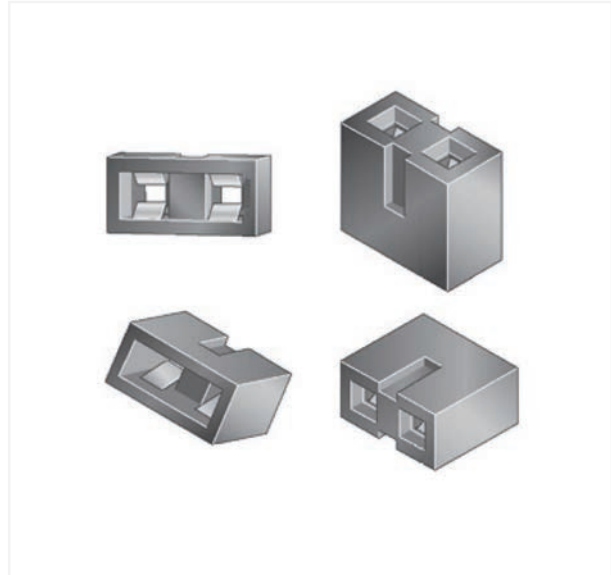

FEATURES & BENEFITS

- Early entry, dual-beam contacts provide long wiping action for reliable electrical contact



TECHNICAL INFORMATION

MATERIALS

- Housing: High temperature, black thermoplastic
- Flammability rating: UL94V-0
- Contact: Phosphor-bronze
- Plating: Gold or tin over 1.27µm (50µin.) nickel

ELECTRICAL PERFORMANCE

- Current rating: 1A continuous
- Insulation resistance: 1 x 10⁵MΩ min.
- Contact resistance: 25mΩ
- Dielectric withstanding voltage: 650V
- Voltage rating: 200V

ENVIRONMENTAL

- Operating temperature range: -55°C to +125°C



MECHANICAL PERFORMANCE

- Mating cycles (durability): 50
- Insertion force per contact: 6.41 N (650gf) max.
- Withdrawal force per contact: 0.49 N (50gf) min.

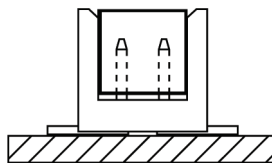
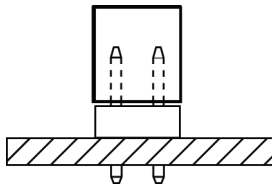
TYPICAL APPLICATIONS



SPECIFICATIONS

-  File no. E66906
-  File no. LR46923
- Product drawing: By 5-digit base part number
- Product specification: DPS-12-012

APPROVALS AND CERTIFICATIONS

- This product is RoHS compatible according to the European Union Directive 2002/95/IEC

PACKAGING

- Bags

PROCESSING INFORMATION

- Compatible with wave, vapor-phase, and IR reflow soldering processes

INSERTION DEPTH

- 2.24mm min. [provides .381mm wipe]



PART NUMBERS

CORE RANGE

86730 — 101LF

8 6 7 3 0 — PLATING 0 1 LF

0.76µm (30µin.) gold on mating area, 2-6µm (79-237µin.) tin on solder side	1
Gold flash	0

PRODUCTS

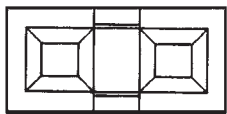
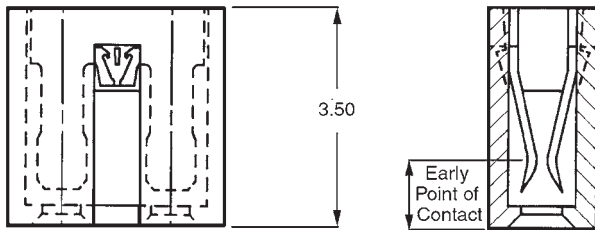
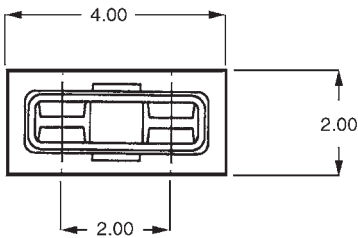

Dimension in mm

Disclaimer

Please note that the above information is subject to change without notice.

MINITEK® SHROUDED VERTICAL HEADERS



FEATURES & BENEFITS

- 4-wall design prevents mis-mating
- Selective plating
- Co-planarity 0.1 (SMT)



TECHNICAL INFORMATION

MATERIALS

- Housing: High temperature, cream-coloured thermoplastic
- Flammability rating: UL94V-0
- Pin: Phosphor-bronze
- Plating: Gold/GXT over 1.27µm (50µin.) nickel

ELECTRICAL PERFORMANCE

- Current rating: 2A continuous
- Insulation resistance: 1 x 10⁵MΩ min.
- Contact resistance: 25mΩ max.
- Dielectric withstanding voltage: 650V
- Voltage rating: 200V



ENVIRONMENTAL

- Operating temperature range: -40°C to +125°C

MECHANICAL PERFORMANCE

- Mating cycles (durability): 100

SPECIFICATIONS

-  File no. E66906
-  File no. LR46923
- Product drawing: 98414 or 98424
- Product specification: DPS-12-011 and GS-12-163
- Tape and reel packaging data: TA-884

APPROVALS AND CERTIFICATIONS

- This product is RoHS compatible according to the European Union Directive 2002/95/IEC

PACKAGING

- Standard:
 - TMT in tubes (04 to 06 pos. packed in box)
 - SMT in tape-and-reel
- Optional: SMT in tubes (04 and 06 in box)

PROCESSING INFORMATION

- Compatible with wave, vapor-phase, and IR reflow soldering processes

TYPICAL APPLICATIONS

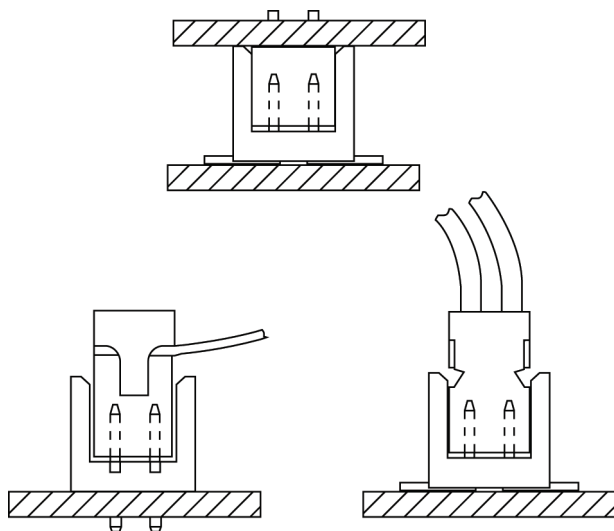

PART NUMBERS

CORE RANGE

98424 — G 52 — XX ALF

XX = 04, 06, 08, 10, 12, 16, 20

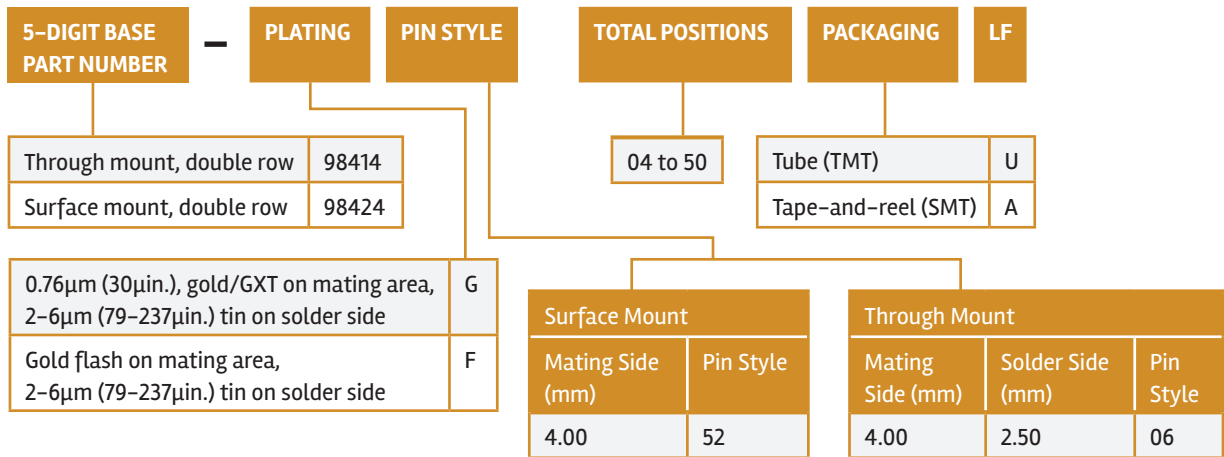

PRODUCT

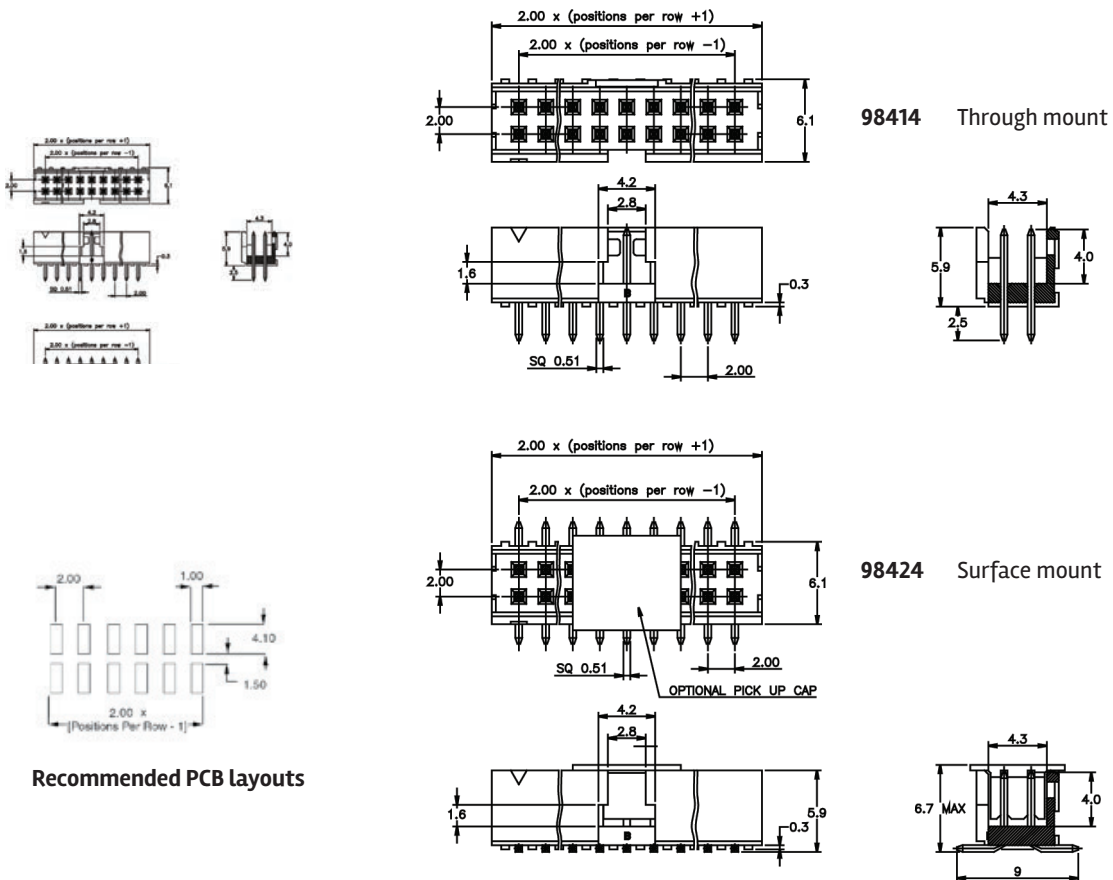

Dimension in mm

For more information,
please contact: Communications@fci.com
or visit us at www.fci.com

Disclaimer
Please note that the above information is subject to change without notice.



MINITEK® SHROUDED RIGHT ANGLE HEADERS

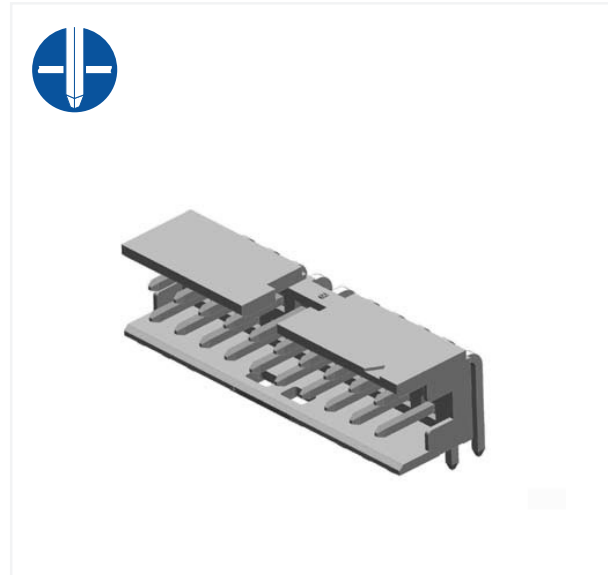

FEATURES & BENEFITS

- 4-wall design prevents mis-mating
- Selective plating



TECHNICAL INFORMATION

MATERIALS

- Housing: High temperature, cream-coloured thermoplastic
- Flammability rating: UL94V-0
- Pin: Phosphor-bronze
- Plating: Gold/GXT over 1.27µm (50µin.) nickel

ELECTRICAL PERFORMANCE

- Current rating: 2A continuous
- Insulation resistance: 1 x 10⁵MΩ min.
- Contact resistance: 25mΩ max.
- Dielectric withstanding voltage: 650V
- Voltage rating: 200V

ENVIRONMENTAL

- Operating temperature range: -40°C to +125°C



MECHANICAL PERFORMANCE

- Mating cycles (durability): 100

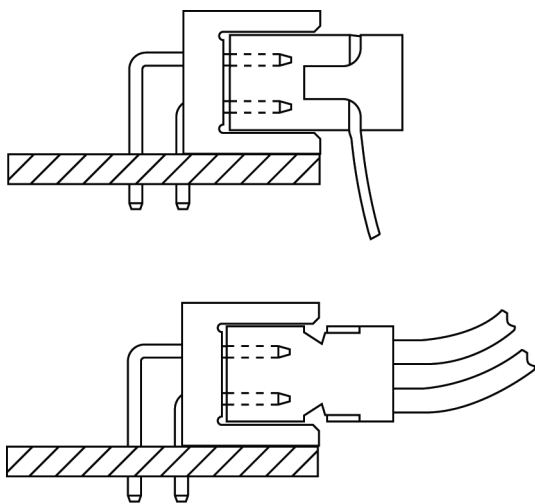
TYPICAL APPLICATIONS



SPECIFICATIONS

-  File no. E66906
-  File no. LR46923
- Product drawing: 98464
- Product specification: DPS-12-011 and GS-12-163

APPROVALS AND CERTIFICATIONS

- This product is RoHS compatible according to the European Union Directive 2002/95/IEC

PACKAGING

- Standard: Tubes (04 pos. packed in box)

PROCESSING INFORMATION

- Compatible with wave, vapor-phase, and IR reflow soldering processes

PART NUMBERS



0.76µm (30µin.) gold/GXT on mating area, 2-6µm (79-237µin.) tin on solder side	G
Gold flash on mating area, 2-6µm (79-237µin.) tin on solder side	F

04 to 50 (Double row)

PRODUCTS

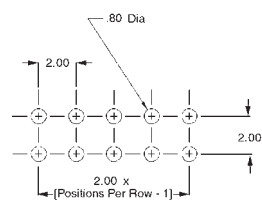

Recommended PCB layouts

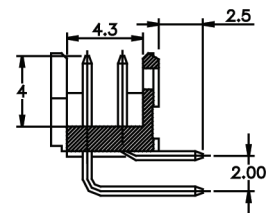
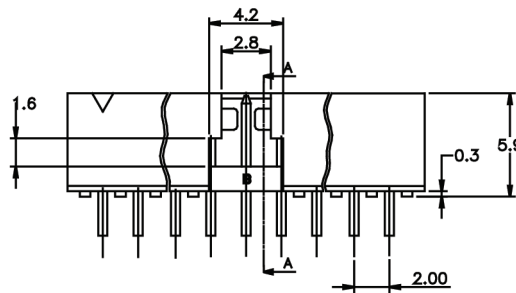
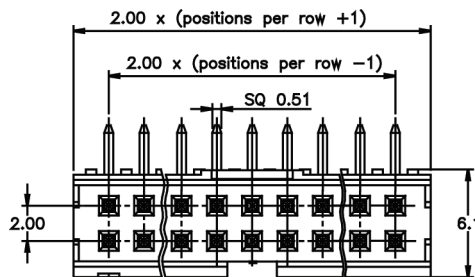

Dimension in mm

MINITEK® SHROUDED HEADERS, PIN-IN-PASTE

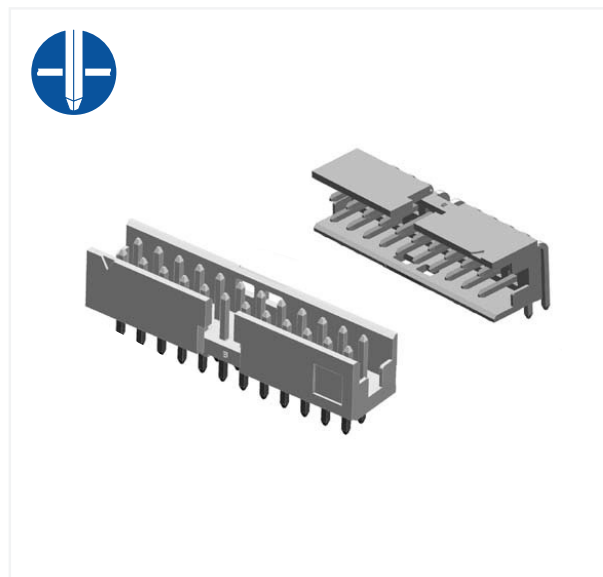

MINITEK® SHROUDED HEADERS, PIN-IN-PASTE

TECHNICAL INFORMATION

MATERIALS

- Housing: High temperature, black thermoplastic
- Flammability rating: UL94V-0
- Pin: Phosphor-bronze
- Plating: Gold/GXT over 1.27µm (50µin.) nickel

ELECTRICAL PERFORMANCE

- Current rating: 3A continuous
- Insulation resistance: $1 \times 10^5 \text{M}\Omega$ min.
- Contact resistance: 25mΩ max.
- Dielectric withstanding voltage: 650V
- Voltage rating: 200V



ENVIRONMENTAL

- Operating temperature range: -55°C to +125°C

MECHANICAL PERFORMANCE

- Latching retention force: 30 N min.

SPECIFICATIONS

-  File no. E66906
-  File no. LR46923
- Product drawing: 8-digit part number
- Product specification: DPS-12-011 and GS-12-163
- Application specification: TA-895
- Reflow prpfile: TA-842

PACKAGING

- Tubes (04 pos. packed in box)
- Tape-on-reel with pick up cap

PROCESSING INFORMATION

- Compatible with wave, vapor-phase, and IR reflow soldering processes

TYPICAL APPLICATIONS

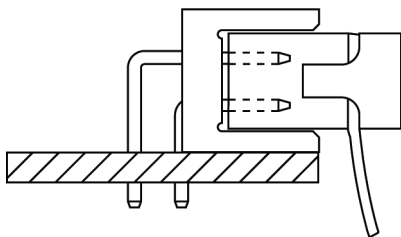
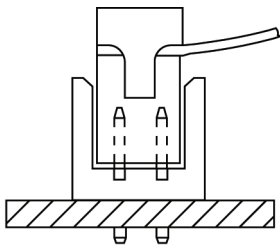

PART NUMBERS

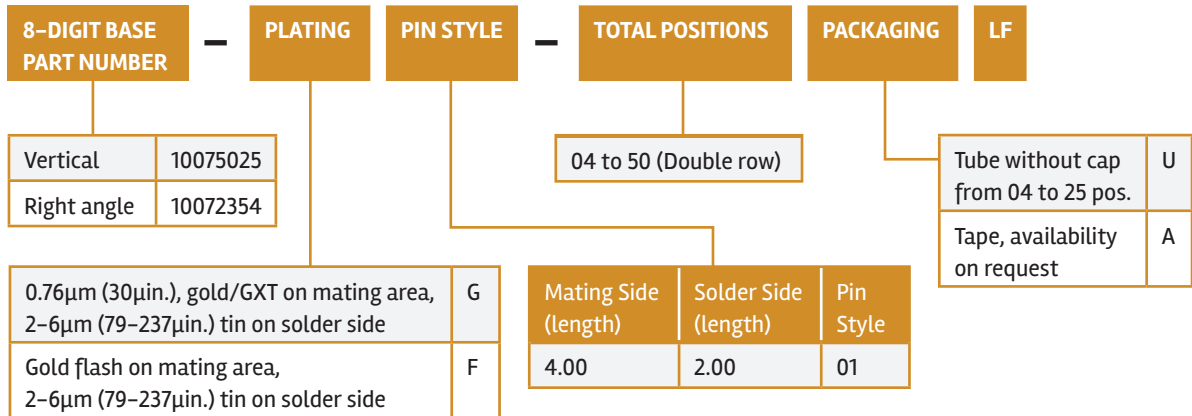

PRODUCT

10075025 Vertical

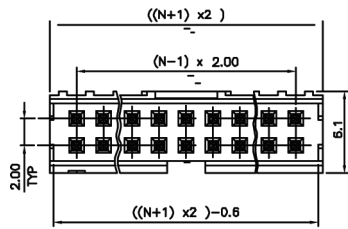

10072354 Right angle

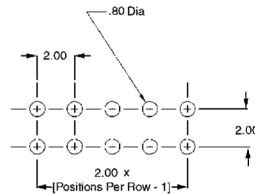
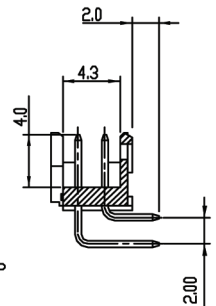
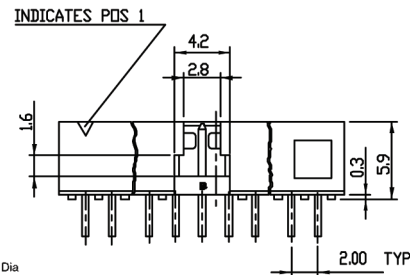
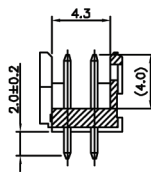
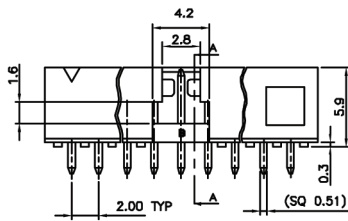
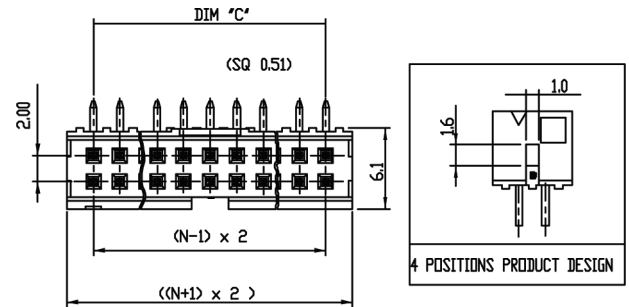

Recommended PCB layouts

Dimension in mm

MINITEK® SHROUDED HEADERS EJECT LATCH

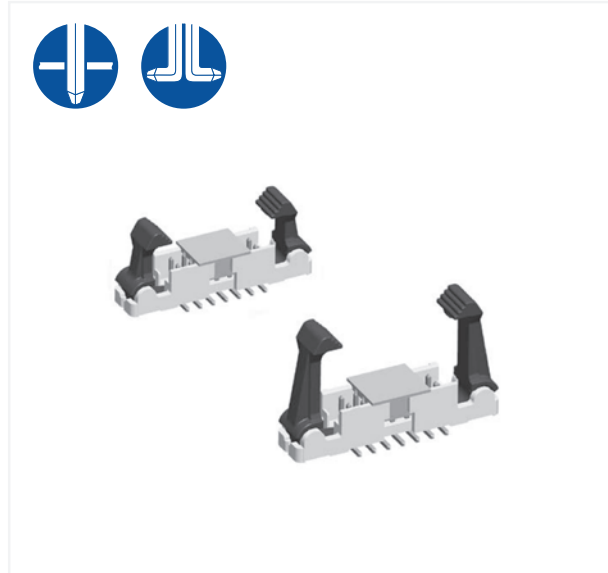

FEATURES & BENEFITS

- Secure latching of cable connector
- Easy ejection when required
- Works with IDC connectors with or without strain relief
- Low profile

TECHNICAL INFORMATION

MATERIALS

- Housing: Body, cream-colored LCP, Latch black PA
- Flammability rating: UL94V-0
- Pin: Phosphor-bronze
- Plating: Gold/GXT over 1.27µm (50µin.) nickel

ELECTRICAL PERFORMANCE

- Current rating: 2A continuous
- Insulation resistance: 1 x 10⁵MΩ min.
- Contact resistance: 25mΩ max.
- Dielectric withstanding voltage: 650V
- Voltage rating: 200V

ENVIRONMENTAL

- Operating temperature range: -40°C to +125°C

MECHANICAL PERFORMANCE

- Latching retention force: 30 N min.

TYPICAL APPLICATIONS

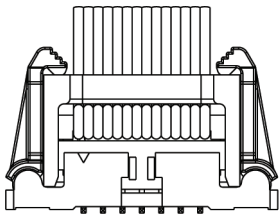

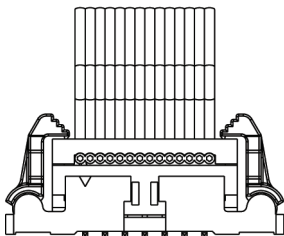

With strain relief
standard latch



Without strain relief
low profile latch

SPECIFICATIONS

-  File no. E66906
-  File no. LR46923
- Product drawing: 8-digit part number
- Product specification: GS-12-469

APPROVALS AND CERTIFICATIONS

- This product is RoHS compatible according to the European Union Directive 2002/95/IEC

PACKAGING

- Standard: Tubes

PROCESSING INFORMATION

- Compatible with wave, vapor-phase, and IR reflow soldering processes

PART NUMBERS

CORE RANGE

10078991	G	22	XX	U	LF
10078991	G	02	XX	U	LF

XX = 06, 08, 10, 12

8-DIGIT BASE PART NUMBER		G	PIN STYLE	LATCH TYPE	TOTAL POSITIONS	PACKAGING	LF	
Vertical TMT	10078991	G	Solder Side	Standard latch	6, 8, 10, 12, 14, 24, 30, 40, 44, 50	Tube, for through mount	U	
Vertical SMT	10078995			Low profile latch				2
0.76µm (30µin.) gold/GXT on mating area			Style					
			SMT	0	Tape-and-reel, SMT only*			A
			2.50mm TMT	2	Tube with cap, SMT only			B
			3.10mm TMT	3				

* As available

PRODUCT

10078991 Vertical TMT

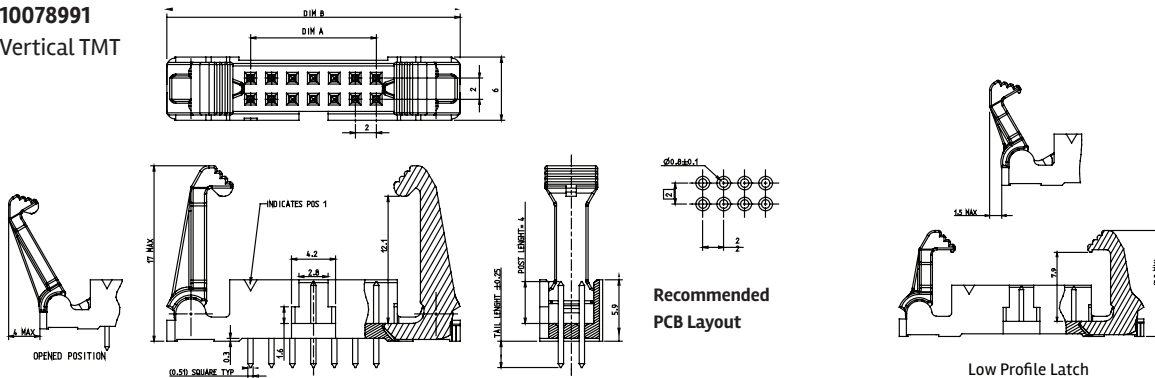

10078995 Vertical SMT

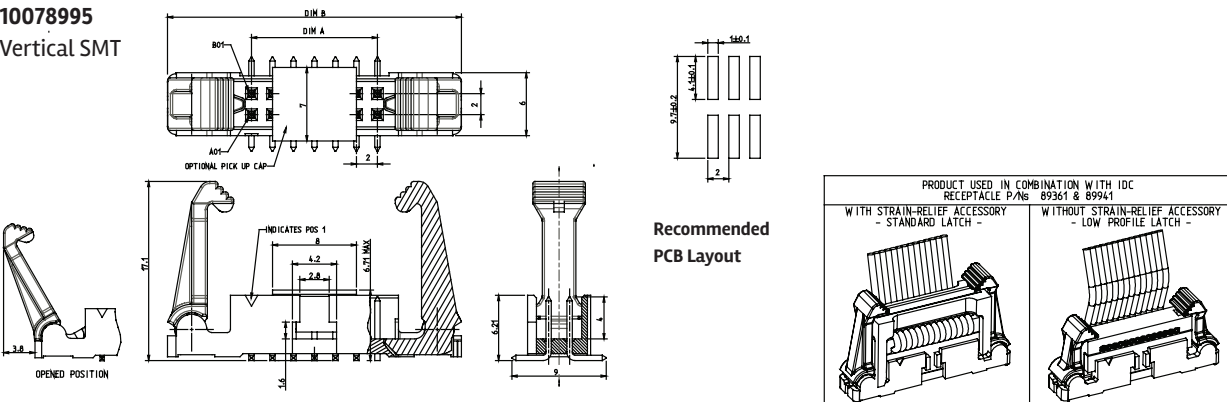

Dimension in mm

For more information, please contact: Communications@fci.com or visit us at www.fci.com

Disclaimer

Please note that the above information is subject to change without notice.

MINITEK® CRIMP-TO-WIRE HOUSINGS AND CONTACTS



FEATURES & BENEFITS

- Dual-beam contact design for highly reliable electrical performance
- Latching key assures proper alignment and friction retention



MINITEK® CRIMP-TO-WIRE HOUSING AND CONTACTS



TECHNICAL INFORMATION

MATERIALS

- Housing: Black thermoplastic
- Flammability rating: UL94V-0
- Contact: Phosphor-bronze
- Plating: Gold or tin over 1.27µm (50µin.) nickel

ELECTRICAL PERFORMANCE

- Current rating: 2A continuous
- Insulation resistance: $1 \times 10^5 \text{M}\Omega$ min.
- Contact resistance: 20mΩ max.
- Dielectric withstanding voltage: 650V
- Voltage rating: 200V



ENVIRONMENTAL

- Operating temperature range: -40°C to +125°C

MECHANICAL PERFORMANCE

- Mating cycles (durability): 100
- Contact retention to housing: 7.83 N (800gf) min.
- Mating force per contact: 1.77 N (180gf) max.
- Unmating force per contact: 0.20 N (20gf) min.

SPECIFICATIONS

-  File no. E66906
-  File no. LR46923
- Product drawing:
 - 77138 or 77139 – Contact
 - 69307, 90311 – Housing
- Product specification: 110-036
- Application specification: 100-006, TA-959

APPROVALS AND CERTIFICATIONS

- This product is RoHS compatible according to the European Union Directive 2002/95/IEC

PACKAGING

- Reels – Contacts
- Bags – Housings

PROCESSING INFORMATION

- Compatible with wave, vapor-phase, and IR reflow soldering processes

INSERTION DEPTH

- 2.40mm min. to 3.30mm max. [provides .381mm wipe]
- 3.63mm min. to 4.00mm max. [provides .381mm wipe in housing]

TYPICAL APPLICATIONS

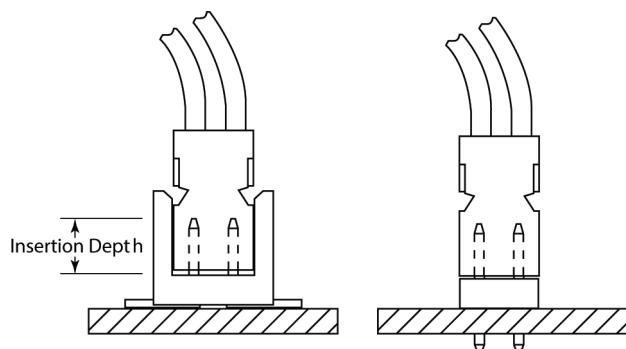

PART NUMBERS

CORE RANGE

77138	—	101LF
10087010	—	0XXLF

XX = 04, 06, 08, 10, 12, 16, 20

CONTACTS

77138	—	PLATING	0	1	LF
26 AWG to 30 AWG		0.76µm (30µin.) gold on mating area		1	
		Gold flash		0	

HOUSINGS

90311	—	0	TOTAL POSITIONS	LF
04 to 50 (Double row)				

PRODUCT

CONTACTS

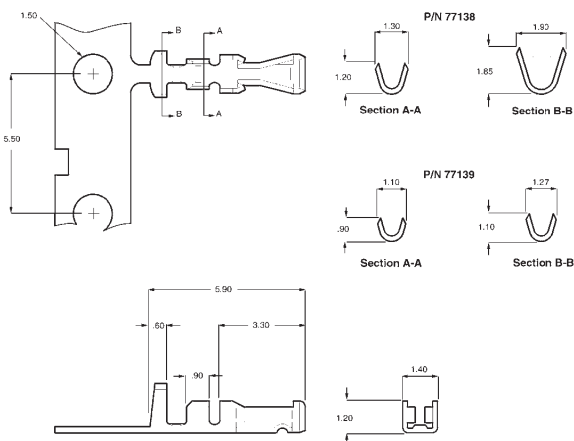

HOUSINGS

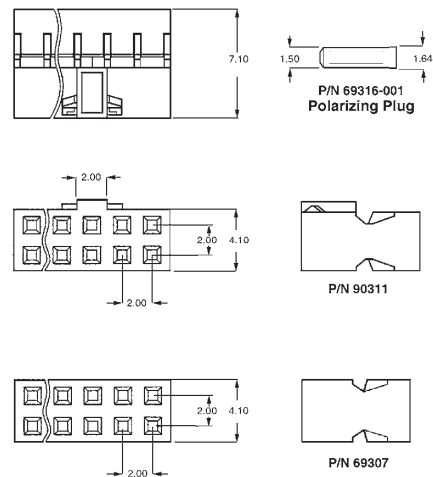

Dimension in mm

MINITEK® CRIMP-TO-WIRE ACTIVE LATCH HOUSINGS

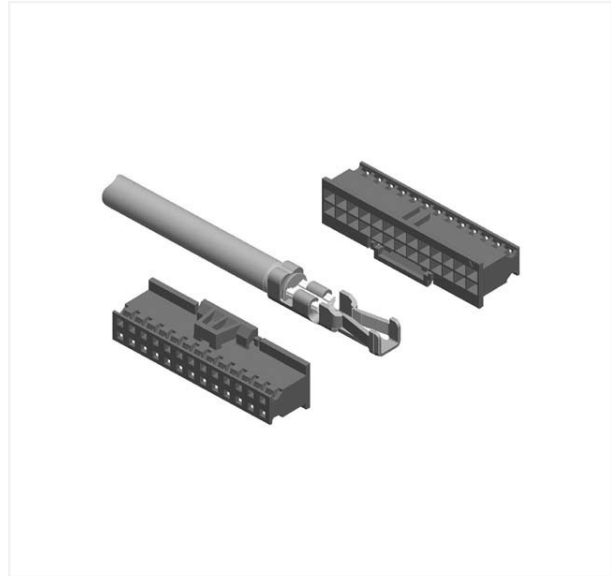

FEATURES & BENEFITS

- Latching retention 15/25 N (depending on size) due to latch alone
- Latches with audible click
- Mates with standard Minitex® headers
- Latch can be released and parts unmated

TECHNICAL INFORMATION

MATERIALS

- Housing: Polyamide, black
- Flammability rating: UL94V-0

ELECTRICAL PERFORMANCE

- Insulation resistance: $1 \times 10^5 \text{M}\Omega$ min.
- Dielectric withstanding voltage: 500V

ENVIRONMENTAL

- Operating temperature range: -55°C to $+125^\circ\text{C}$



MECHANICAL PERFORMANCE

- Latching retention force: 15 N min. (for 2x3 and 2x4 pos.)
- Latching retention force: 25 N min. (for 2x5 and 2x25 pos.)

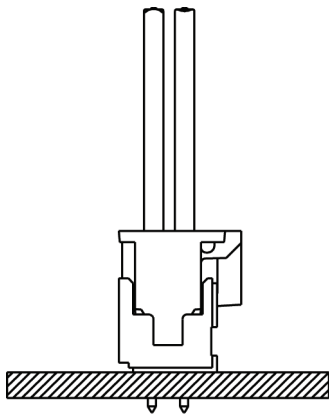
TYPICAL APPLICATIONS



SPECIFICATIONS

-  File no. E66906
-  File no. LR46923
- Product drawing: By 8-digit part number
- Product specification: GS-12-415

APPROVALS AND CERTIFICATIONS

- This product is RoHS compatible according to the European Union Directive 2002/95/IEC

PACKAGING

- Standard: Plastic bags



PART NUMBERS

CORE RANGE

77138 — 101LF

10073599 — 0XXLF

XX = 04, 08, 10, 12, 16, 20

CONTACTS

77138 — PLATING 0 1 LF

26 AWG to 30 AWG

0.76µm (30µin.) gold on mating area	1
Gold flash	0

HOUSINGS

10073599 — 0 TOTAL POSITIONS LF

06 to 50

PRODUCT

CONTACTS

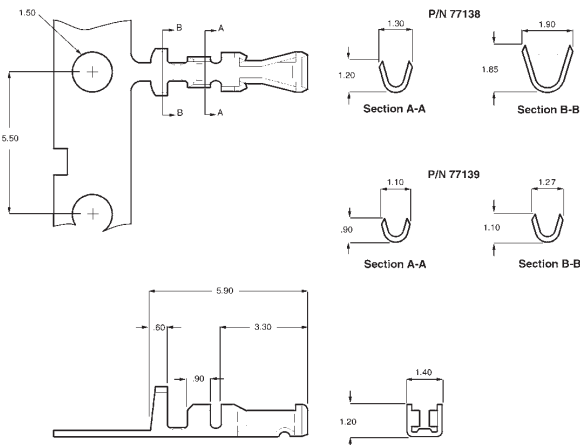

HOUSINGS

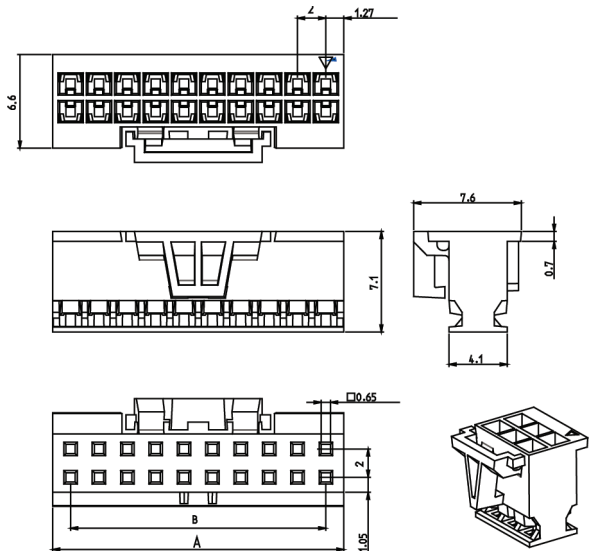

DESIGN FOR 10073599-006LF & 10073599-008LF ONLY

Dimension in mm

Disclaimer

Please note that the above information is subject to change without notice.

MINITEK® IDC RECEPTACLE



FEATURES & BENEFITS

- Early entry, single-beam contacts provide long wiping action for reliable electrical contact
- Center key polarization and friction latch options



TECHNICAL INFORMATION

MATERIALS

- Housing: Black thermoplastic
- Flammability rating: UL94V-0
- Contact: Phosphor-bronze
- Plating: Gold over 1.27µm (50µin.) nickel

ELECTRICAL PERFORMANCE

- Current rating: 1A continuous
- Insulation resistance: 1 x 10⁵MΩ min.
- Contact resistance: 30mΩ max.
- Dielectric withstanding voltage: 650V



ENVIRONMENTAL

- Operating temperature range: -40°C to +105°C

MECHANICAL PERFORMANCE

- Mating cycles (durability): 100

SPECIFICATIONS

-  File no. E66906
-  File no. LR46923
- Product drawing: 89947 or 89361
- Product specification: BUS-12-115

APPROVALS AND CERTIFICATIONS

- This product is RoHS compatible according to the European Union Directive 2002/95/IEC

PACKAGING

- Tubes

INSERTION DEPTH

- 2.55mm min. to 4.57mm max.
[provides .381mm wipe]

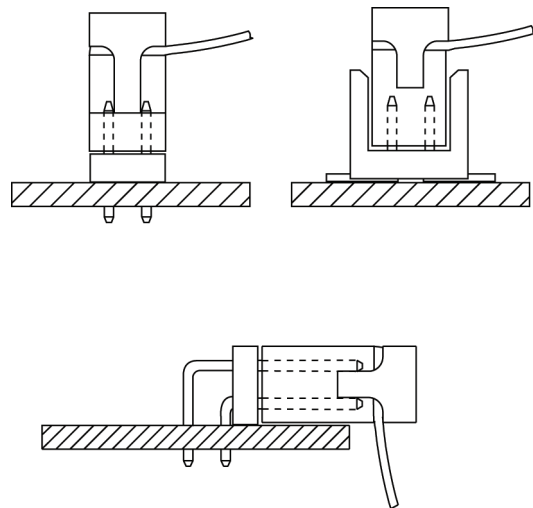

PART NUMBERS

CORE RANGE

89361 – 7XXLF

XX = 06, 08, 10, 12, 16, 20

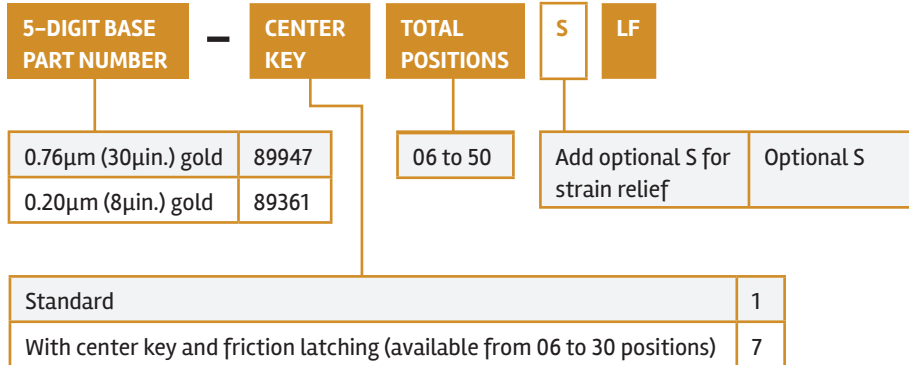

PRODUCT

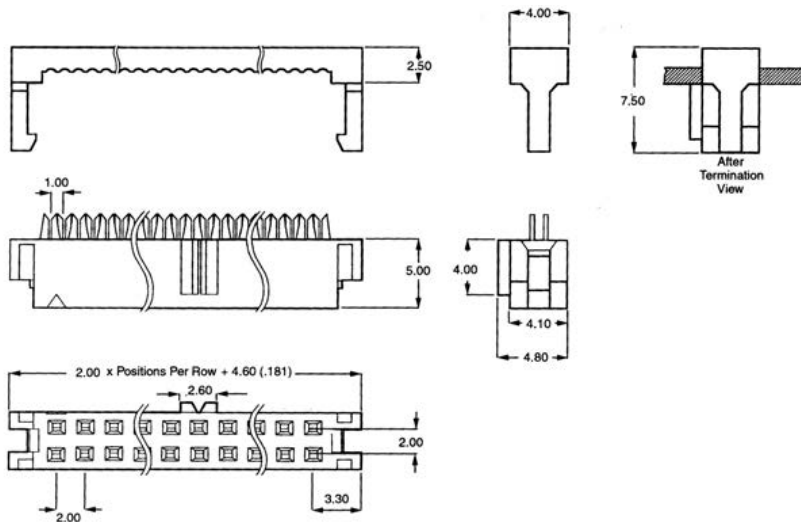

Dimension in mm



MORE OPTIONS

If you need something more than the standard parts in this catalog, Basics+ has many more options to help you in your design process. Here are just some examples.

- Locating pins on SMT headers



- Polarized (missing) positions



- Kinked legs



- Press-fit pins

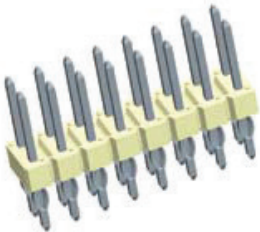

- Add-on latches for headers

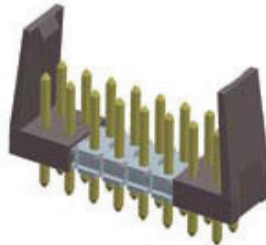

- Wide body headers

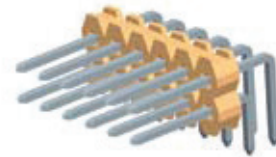

- Crimp-to-wire pin

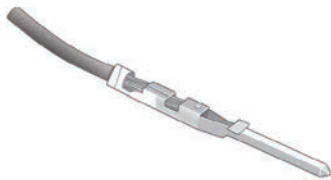

- Printed housings



- Additional plating options

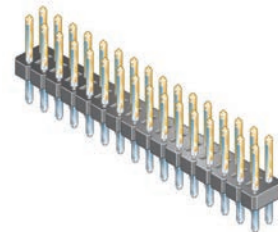

- Pin-in-paste headers

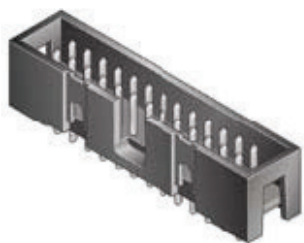

X-ON Electronics

Largest Supplier of Electrical and Electronic Components

Click to view similar products for [Headers & Wire Housings](#) category:

Click to view products by [Amphenol](#) manufacturer:

Other Similar products are found below :

[95000-104TRLF](#) [10135584-644402LF](#) [DF62W-EP2022PCA](#) [95000-106TRLF](#) [DF62W-2022SCA](#) [DF62W-EP2022PC](#) [2203348](#) [DF62W-2022SC](#) [1084018](#) [1029039](#) [1084017](#) [802-10-012-10-002000](#) [1112640](#) [1112639](#) [891-007-9SS-BST1T](#) [000-34000](#) [0008550134](#) [0009482033](#) [0009507031](#) [57102-F02-18ULF](#) [57102-S06-03LF](#) [57202-S52-04LF](#) [PCN6-15S-2.5E](#) [0039019024](#) [58102-G61-06LF](#) [582553-1](#) [0009485154](#) [0009508121](#) [0022285053](#) [0050291907](#) [018731A](#) [LY20-4P-DT1-P1E-BR](#) [02.125.8002.8](#) [60101931](#) [60598-1 \(Cut Strip\)](#) [M1625-3R/100](#) [61062-3](#) [61082-181009](#) [CSU011177004](#) [636-1427](#) [638009-1](#) [641938-9](#) [641991-4](#) [644168-1](#) [644827-2](#) [647662-1](#) [65039-019ELF](#) [65692-001LF](#) [65781-018](#) [65781-047](#)