

# Amphenol® QWL Series Cylindrical Connectors

12-053-4



# Amphenol

## TABLE OF CONTENTS

<i>Description</i>	<i>Page</i>	<i>Description</i> .....	<i>Page</i>
Amphenol® Heavy Duty Cylindrical Connectors		QWL - accessories	
QWL Series .....	2	10-130380 cable sealing adapter (with clamp bars) .....	43, 44
QWL the environmental connector .....	3	QWL - accessories 10-10133X cable sealing adapters .....	45-48
QWL how to order .....	4, 5	QWL - accessories 10-113637 cable sealing adapter (with woven strain relief) .....	49-52
QWL 10-1070 wall mount receptacle .....	6	QWL - accessories adapter, cable clamp .....	53
QWL 10-1071 cable connecting plug .....	7	QWL - accessories adapter, cable clamp, sealing plugs .....	54-56
QWL 10-1072 box mount receptacle .....	8	QWL - accessories protection caps .....	57, 58
QWL 10-1073 jam nut receptacle (wall mount) .....	9	QWL - accessories flange gasket, grip banding clamp .....	59
QWL 10-1074 thru bulkhead receptacle .....	10	QWL crimp contacts .....	60
QWL 10-1076 straight plug .....	11	QWL solder contacts .....	61
QWL 10-1077 flange mount plug .....	12	QWL application tools (crimp type) .....	62
QWL 10-1079 jam nut receptacle (box mount) .....	13	QWL thermocouple contacts and arrangements .....	63-69
QWL insert arrangements selection guide .....	14-16	Other Heavy Duty Connectors Offered by Amphenol .....	70
QWL alternate positioning .....	17	Sales Office Listing	
QWL contact insert arrangements .....	18-29		
QWL special contact insert arrangements .....	30-40		
QWL - accessories cabling information .....	41, 42		

Amphenol Aerospace operates Quality Systems that are Certified to ISO-9001 and AS-9100 by third party Registrars.

For additional information concerning the Amphenol® QWL Series Cylindrical Connector, or if there are special application requirements, contact your local sales office or

Amphenol Corporation  
Amphenol Aerospace  
40-60 Delaware Ave.  
Sidney, New York 13838-1395  
Telephone: 607-563-5011  
Fax: 607-563-5351  
**www.amphenol-aerospace.com**  
(Most Amphenol catalogs can be viewed, printed and down-loaded from the website)

# Amphenol® Heavy Duty Cylindrical Connectors

## QWL Series



wall mount receptacle



thru bulkhead receptacle



cable connecting plug



straight plug



box mount receptacle



flange mount plug



jam nut receptacle  
(wall mount)



jam nut receptacle  
(box mount)

**Amphenol® QWL Series Connectors are tailor made for compact, heavy duty industrial use.**

The outstanding performance of this series makes it well suited for ship-board installations and ground support power distribution applications where physical strength and dependability are key requirements.

**The QWL Series are a versatile, economical alternative to military qualified designs.**

Equivalent MS shell sizes and insert arrangements offer compatibility with all standard cable types. MIL-C-22992 environmental connector requirements (see page 1) are used as a performance criteria base for this series to assure reliability under the most severe conditions.

**The design features of this connector series provide:**

- **Exceptional Service** - high strength aluminum shells with Alumilite 225\* hard anodic finish and shock resistant resilient inserts.
- **Foolproof Operation** - rugged double stub coupling threads, left hand accessory threads and simple single keyway mating.
- **Versatility** - both MS and custom insert patterns available for a wide variety of multiconductor cables.

A complete line of accessories is available for use with QWL Series connectors, including cable sealing and clamp adapters, protective covers, flange gaskets and banding clamps.

\* Registered trademark of Aluminum Company of America

# QWL

## the environmental connector

- **HIGH CURRENT CAPACITY** for power distribution network and inputs to large equipment
- **RUGGED CONSTRUCTION** dictated by the working environment, high strength aluminum shells with Alumilite 225\* hard anodic finish, shock resistant resilient inserts, gaskets or “O” rings at appropriate surfaces for perfect weather tight connections.
- **SERVICEABILITY AND FOOL-PROOF OPERATION** with fast coupling, easily maintained double stub threads, left hand accessory threads and single keyway mating.
- **VERSATILITY** - both MS and custom insert patterns available to accommodate a wide variety of multi conductor cables.

CONDITION	CONFIGURATION	DESCRIPTION	REFERENCE
THERMAL SHOCK	UNMATED	Five complete one hour temperature cycles of -55°C to +125°C	MIL-STD-1344 method 1003 test condition
MOISTURE RESISTANCE (Cable mounted connectors)	MATED	Ten complete 24 hour cycles of +25°C to +65°C temperature at 90% to 98% humidity	MIL-STD-202 method 106
DURABILITY	MATED	500 complete mating/unmating cycles	MIL-C-22992
SALT SPRAY (Corrosion)	UNMATED	48 hour exposure to atomized 5% saline solution at +35°C	MIL-STD-1344 method 1001
VIBRATION	MATED	10 to 55 Hz, .06 inch total excursion in 1 minute cycles for 6 hours 55 to 2000 Hz, 10G peak amplitude sweep	MIL-STD-1344 method 2005
HIGH IMPACT	MATED	Nine hammer blows from 1, 3 and 5 feet, three each in three axes on mounting panel	MIL-STD-202 method 207
FLUID IMMERSION	UNMATED	20 hours immersion in hydraulic fluid and lubricating oil	MIL-C-22992
WATER IMMERSION	MATED	4 hours immersion at 1 atmosphere pressure differential	MIL-C-22992

\* Registered trademark of Aluminum Company of America

# QWL

## how to order

QWL heavy duty cylindrical connectors are ordered by Amphenol® part number only. To illustrate the ordering procedure, part number 10-107628-5P is shown as follows:

PART NUMBER  
 $\frac{10}{1} - \frac{107}{2} \frac{6}{3} \frac{28-5}{4} \frac{P}{5}$

See code below:

**1. Base Number Prefix** - used to define contact type and finish.

- 10- Solder type contacts, silver plated (Standard)
- 75- Crimp type contacts, silver plated
- 81- Crimp type contacts, plated .0001 gold over silver
- 82- Crimp type contacts for MIL-C-13777 cable, silver plated
- 83- Crimp type contacts for MIL-C-13777 cable, plated .0001 gold over silver
- 85- Crimp type contacts plated .00005 gold over silver

**2. Base Number** - QWL Series Heavy Duty Cylindrical Connector.

**3. Shell Style** -

- 0 designates wall mount receptacle
- 1 designates cable connecting plug
- 2 designates box mount receptacle
- 3 designates jam nut receptacle with rear accessory threads (wall mount)
- 4 designates thru bulkhead receptacle
- 6 designates straight plug
- 7 designates flange mount plug
- 9 designates jam nut receptacle (box mount)

**4. Shell Size/Insert Arrangement** - Amphenol® QWL connectors are available in equivalent MS shell sizes with all current MS insert arrangements as well as a large selection of special arrangements for power and signal circuits. Select the required insert arrangement number from those shown on pages 18-40.

**5. Contact Type/Alternate Insert Rotations** - P for pin, S for socket. When an alternate position of the connector insert is required to prevent cross mating of connectors, a different letter (other than P or S) is used. Select from the table below the Amphenol® letter which indicates both type of contact, and insert rotation desired. Refer to page 17 for alternate insert rotations.

PIN CONTACTS		SOCKET CONTACTS	
MS LETTERS	AMPHENOL® LETTER	MS LETTERS	AMPHENOL® LETTER
P	P (normal)	S	S (normal)
PW	G	SW	H
PX	I	SX	J
PY	K	SY	L
PZ	M	SZ	N

# QWL

## how to order, cont.

### ACCESSORIES

**Cable Sealing Adapters** - these are the basic connector accessories which provide moisture proofing and cable strain relief. Selection is made on the basis of accessory style, shell size and cable dimensions. To illustrate the ordering procedure, part number 10-101335-361 is shown as follows:

PART NUMBER  
10 - 101335 - 361  
1                      2

See code below:

- 1. Accessory Base Number** - refer to pages 41 through 52 for descriptions and dimensional data. 10-101332 designates short barrel length with woven strain relief grip
- 10-101333 designates short barrel length without strain relief
  - 10-101334 designates short barrel length with woven strain relief grip and attaching ring for protection cap with bead chain
  - 10-101335 designates short barrel length with attaching ring for protection cap with bead chain
  - 10-101380 designates short barrel length with attaching ring for protection cap with bead chain and clamp type strain relief bars
  - 10-113637 designates long barrel length with woven strain relief and attaching ring for protection cap with bead chain

**2. Part Number** – represents connector shell size and range of cable diameters accommodated by the sealing adapter. Refer to the page listed below to determine the part number required for the accessory style being used:

Accessory Series	Page
10-10133X	46 - 48
10-130380	44
10-113637	50 - 52

#### **Cable Clamp 10-749XX-( ) and Adapter 10-113196-XX**

Connectors which require weatherproofing on open wire cables are provided with a moisture seal by this cable clamp, a modification of the MS3057B design. A rubber grommet with holes for individual wires is used in place of the sleeve. As the assembly is tightened, the grommet is compressed around each wire, sealing out moisture.

Order this clamp by the part number listed on page 53 to accommodate the connector being used. Suffix the part number with the connector insert arrangement number.

To attach the cable clamp to the left hand accessory threads of QWL connectors, Adapter 10-113196-XX is needed. Finish is non-conductive Alumilite. Order by adapter part number listed on page 53 to accommodate the connector shell size being used. For a moisture proof seal, unused grommet holes must be filled with the appropriate size sealing plug or sealing rod selected from the table on page 53. Sealing plug or sealing rods must be ordered separately.

**M85049/1 Cable Clamp and Adapter 10-113138-XX** - order this clamp by the M85049( )C part number listed on page 55 to accommodate the cable type being used. To attach the cable clamp to the left hand accessory threads of QWL connectors, Adapter 10-113138-XX is needed. Order by adapter part number listed on page 55 to accommodate the connector shell size being used. Standard finish on the clamp is olive drab, cadmium plate. Adapter finish is non-conductive Alumilite. MS3420-( )A sleeve, to facilitate sealing on smaller diameter cables, must be ordered separately. MS3420-( )A sleeves may be nested to accommodate smaller cable diameters.

#### **Plug Protection Caps -**

- 10-101046-( ) designates plug cover with chain, Alumilite 225 finish
  - 10-101531-( ) designates plug cover with chain and eyelet end, Alumilite 225 finish
- Order these plug covers by the part number listed on page 57 for the appropriate connector shell size.

#### **Receptacle Protection Caps -**

- 10-101063-( ) designates receptacle cover with chain, Alumilite 225 finish
  - 10-101048-( ) designates receptacle cover with chain and eyelet, Alumilite 225 finish
- Order these receptacle covers by the part number listed on page 57 for the appropriate connector shell size.

#### **Flange Gasket -**

- 10-36675-( ) for operating temperature range -67° to +275°F
  - 10-40450-( ) for operating temperature range 0° to +257°F
- Order by part number listed on page 59 for appropriate connector shell size.

**10-183249 Grip Banding Clamp** - order this stainless steel clamp by part number listed on page 59 to accommodate cable diameter being used.

# QWL 10-1070XX wall mount receptacle

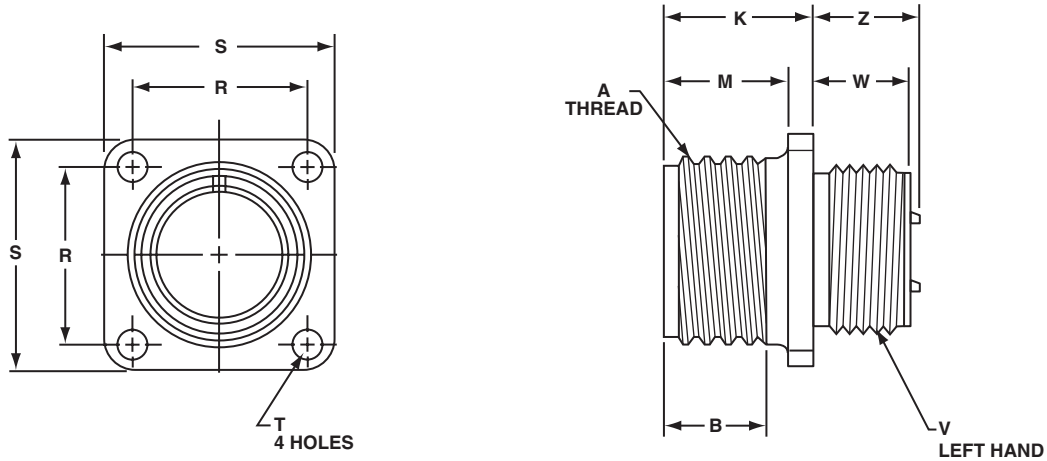

All dimensions for reference only.

Part Number*	Shell Size	A Thread Class 2A	B Min Full Thread	K $\pm .015$	M $+ .016$ $- .000$	R $\pm .005$	S $\pm .020$	T Dia $+ .004$ $- .003$	V Thread Class 2A-LH	W $\pm .010$	Z Max
10-107010	10S	.6250-0.05P-0.1L-DS	.391	.704	.562	.719	1.000	.150	.500-28UNEF	.400	.450
10-107012	12S	.7500-0.1P-0.2L-DS	.391	.704	.562	.812	1.094	.150	.625-24UNEF	.400	.450
10-107013	12	.7500-0.1P-0.2L-DS	.625	.891	.750	.812	1.094	.150	.625-24UNEF	.588	.700
10-107014	14S	.8750-0.1P-0.2L-DS	.391	.704	.562	.906	1.188	.150	.750-20UNEF	.400	.450
10-107015	14	.8750-0.1P-0.2L-DS	.625	.891	.750	.906	1.188	.150	.750-20UNEF	.588	.700
10-107016	16S	1.0000-0.1P-0.2L-DS	.391	.704	.562	.969	1.281	.150	.875-20UNEF	.400	.450
10-107017	16	1.0000-0.1P-0.2L-DS	.625	.891	.750	.969	1.281	.150	.875-20UNEF	.588	.700
10-107018	18	1.1250-0.1P-0.2L-DS	.625	.906	.750	1.062	1.375	.177	1.000-20UNEF	.573	.686
10-107020	20	1.2500-0.1P-0.2L-DS	.625	.906	.750	1.156	1.500	.177	1.125-18NEF	.573	.686
10-107022	22	1.3750-0.1P-0.2L-DS	.625	.906	.750	1.250	1.625	.177	1.250-18NEF	.573	.686
10-107024	24	1.5000-0.1P-0.2L-DS	.625	.968	.812	1.375	1.750	.177	1.375-18NEF	.573	.624
10-107028	28	1.7500-0.1P-0.2L-DS	.625	.968	.812	1.562	2.000	.177	1.625-18NEF	.573	.624
10-107032	32	2.0000-0.1P-0.2L-DS	.625	1.031	.875	1.750	2.250	.209	1.875-16N	.573	.561
10-107036	36	2.2500-0.1P-0.2L-DS	.625	1.031	.875	1.938	2.500	.209	2.0625-16N	.573	.561
10-107040	40	2.5000-0.1P-0.2L-DS	.625	1.031	.875	2.188	2.750	.209	2.3125-16N	.573	.561
10-107044	44	2.7500-0.1P-0.2L-DS	.625	1.031	.875	2.375	3.000	.209	2.625-16UN	.698	.801

\*For complete order number see page 4



# QWL 10-1071XX cable connecting plug

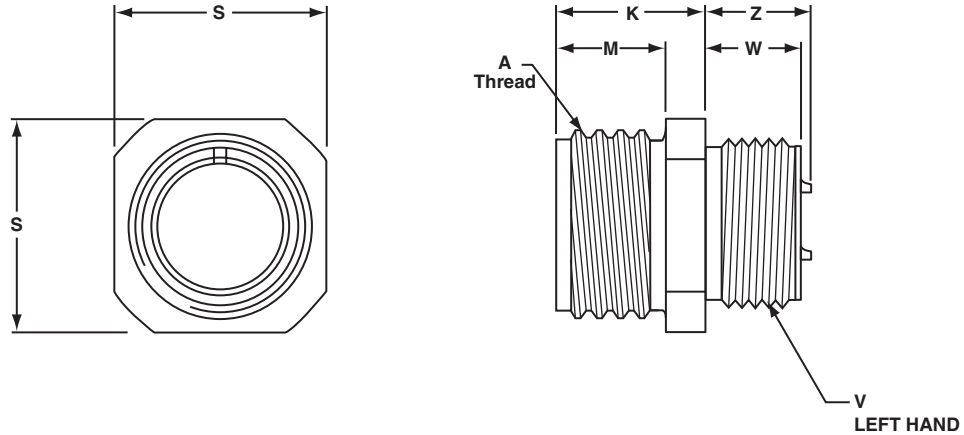

All dimensions for reference only.

Part Number*	Shell Size	A Thread (plated) Class 2A	K ±.015	M +.016 - .000	S ±.020	V Thread Class 2A-LH	W ±.010	Z Max
10-107110	10S	.6250-0.05P-0.1L-DS	.704	.453	.750	.500-28UNEF	.400	.450
10-107112	12S	.7500-0.1P-0.2L-DS	.704	.453	.875	.625-24UNEF	.400	.450
10-107113	12	.7500-0.1P-0.2L-DS	.891	.641	.875	.625-24UNEF	.588	.701
10-107114	14S	.8750-0.1P-0.2L-DS	.704	.453	1.000	.750-20UNEF	.400	.450
10-107115	14	.8750-0.1P-0.2L-DS	.891	.641	1.000	.750-20UNEF	.588	.701
10-107116	16S	1.0000-0.1P-0.2L-DS	.704	.453	1.094	.875-20UNEF	.400	.450
10-107117	16	1.0000-0.1P-0.2L-DS	.891	.641	1.094	.875-20UNEF	.588	.701
10-107118	18	1.1250-0.1P-0.2L-DS	.906	.656	1.281	1.000-20UNEF	.573	.686
10-107120	20	1.2500-0.1P-0.2L-DS	.906	.656	1.375	1.125-18UNEF	.573	.686
10-107122	22	1.3750-0.1P-0.2L-DS	.906	.656	1.500	1.250-18UNEF	.573	.686
10-107124	24	1.5000-0.1P-0.2L-DS	.968	.719	1.625	1.375-18UNEF	.573	.624
10-107128	28	1.7500-0.1P-0.2L-DS	.968	.719	1.875	1.625-18UNEF	.573	.624
10-107132	32	2.0000-0.1P-0.2L-DS	1.031	.656	2.125	1.875-16UN	.573	.561
10-107136	36	2.2500-0.1P-0.2L-DS	1.031	.656	2.375	2.0625-16UNS	.573	.561
10-107140	40	2.5000-0.1P-0.2L-DS	1.031	.656	2.625	2.3125-16UNS	.573	.561
10-107144	44	2.7500-0.1P-0.2L-DS	1.031	.656	3.000	2.625-16UN	.698	.800
10-107148	48	3.0000-0.1P-0.2L-DS	1.031	.656	3.125	2.875-16UN	.698	.800

\*For complete order number see page 4



# QWL 10-1072XX

## box mount receptacle



All dimensions for reference only.

Part Number*	Shell Size	A Thread (Plated) Class 2A	B Min Full Thread	K $+0.026$ $-0.010$	M $+0.016$ $-0.000$	R $\pm 0.005$	S $\pm 0.020$	T Dia $+0.004$ $-0.003$	W $+0.020$ $-0.036$	Y Dia $\pm 0.010$	Z Max
10-107210	10S	.6250-0.05P-0.1L-DS	.391	.703	.562	.719	1.000	.150	.281	.469	.451
10-107212	12S	.7500-0.1P-0.2L-DS	.391	.703	.562	.812	1.094	.150	.281	.594	.451
10-107213	12	.7500-0.1P-0.2L-DS	.625	.891	.750	.812	1.094	.150	.469	.594	.700
10-107214	14S	.8750-0.1P-0.2L-DS	.391	.703	.562	.906	1.188	.150	.281	.719	.451
10-107215	14	.8750-0.1P-0.2L-DS	.625	.891	.750	.906	1.188	.150	.469	.719	.700
10-107216	16S	1.0000-0.1P-0.2L-DS	.391	.703	.562	.969	1.281	.150	.281	.844	.451
10-107217	16	1.0000-0.1P-0.2L-DS	.625	.891	.750	.969	1.281	.150	.469	.844	.700
10-107218	18	1.1250-0.1P-0.2L-DS	.625	.906	.750	1.062	1.375	.177	.453	.969	.686
10-107220	20	1.2500-0.1P-0.2L-DS	.625	.906	.750	1.156	1.500	.177	.453	1.125	.686
10-107222	22	1.3750-0.1P-0.2L-DS	.625	.906	.750	1.250	1.625	.177	.453	1.250	.686
10-107224	24	1.5000-0.1P-0.2L-DS	.625	1.000	.812	1.375	1.750	.177	.359	1.375	.585
10-107228	28	1.7500-0.1P-0.2L-DS	.625	1.000	.812	1.562	2.000	.177	.359	1.594	.591
10-107232	32	2.0000-0.1P-0.2L-DS	.625	1.063	.875	1.750	2.250	.209	.296	1.844	.528
10-107236	36	2.2500-0.1P-0.2L-DS	.625	1.063	.875	1.938	2.500	.209	.296	2.031	.528
10-107240	40	2.5000-0.1P-0.2L-DS	.625	1.063	.875	2.188	2.750	.209	.296	2.281	.528
10-107244	44	2.7500-0.1P-0.2L-DS	.625	1.063	.875	2.375	3.000	.209	.546	2.562	.769
10-107248	48	3.0000-0.1P-0.2L-DS	.625	1.063	.875	2.625	3.250	.209	.546	2.812	.769

\*For complete order number see page 4

# QWL

## 10-1073XX

### jam nut receptacle (wall mount)



Shell Size	K Dia +.005 -.000	G ±.003	U ±.005
10	.880	.518	.625
12, 13	1.005	.562	.688
14, 15	1.130	.606	.750
16, 17	1.255	.699	.875
18	1.380	.739	.938
20	1.505	.783	1.000
22	1.630	.830	1.062
24	1.880	.919	1.188
28	2.130	1.007	1.312
32	2.380	1.096	1.438
36	2.630	1.183	1.562
40	2.880	1.292	1.703

mounting dimensions

Mounting dimensions diagram showing the location of the mounting hole. Dimension U is the distance from the center to the hole. Dimension G is the distance from the center to the hole. Dimension K is the diameter of the hole. A .125 ±.002 DIA. PIN is shown inserted into the hole.

All dimensions for reference only.

Part Number*	Shell Size	A Thread Class 2A	B ±.010	E Thread Class 2A	F Hex ±.010	H Panel Thickness		M ±.010	N ±.015	P ±.010	S ±.010	V Thread Class 2A-LH	W ±.010	Z Max
						Min	Max							
10-107310	10S	.6250-0.5-0.1L-DS	.385	.6875-24UNEF	.875	.094	.227	.844	.469	.375	1.062	.500-28UNEF	.344	.295
10-107312	12S	.7500-0.1P-0.2L-DS	.385	.875-20UNEF	1.062	.094	.200	.906	.469	.442	1.250	.625-24UNEF	.344	.232
10-107313	12	.7500-0.1P-0.2L-DS	.585	.875-20UNEF	1.062	.094	.188	1.094	.641	.442	1.250	.625-24UNEF	.516	.483
10-107314	14S	.8750-0.1P-0.2L-DS	.385	1.000-20UNEF	1.250	.094	.200	.906	.469	.486	1.376	.750-20UNEF	.344	.232
10-107315	14	.8750-0.1P-0.2L-DS	.585	1.000-20UNEF	1.250	.094	.188	1.094	.641	.486	1.376	.750-20UNEF	.516	.483
10-107316	16S	1.0000-0.1P-0.2L-DS	.385	1.125-18UNEF	1.312	.094	.200	.906	.469	.530	1.500	.875-20UNEF	.344	.232
10-107317	16	1.0000-0.1P-0.2L-DS	.585	1.125-18UNEF	1.312	.094	.188	1.094	.641	.530	1.500	.875-20UNEF	.516	.483
10-107318	18	1.1250-0.1P-0.2L-DS	.585	1.250-18UNEF	1.500	.094	.203	1.109	.704	.623	1.750	1.000-20UNEF	.516	.467
10-107320	20	1.2500-0.1P-0.2L-DS	.585	1.375-18UNEF	1.562	.094	.203	1.109	.704	.663	1.875	1.125-18UNEF	.516	.467
10-107322	22	1.3750-0.1P-0.2L-DS	.585	1.500-18UNEF	1.750	.094	.203	1.109	.704	.707	2.000	1.250-18UNEF	.516	.467
10-107324	24	1.5000-0.1P-0.2L-DS	.585	1.625-18UNEF	1.875	.094	.265	1.172	.704	.751	2.125	1.375-18UNEF	.516	.404
10-107328	28	1.7500-0.1P-0.2L-DS	.585	1.875-16UNEF	2.125	.094	.265	1.172	.704	.840	2.375	1.625-18UNEF	.516	.404
10-107332	32	2.0000-0.1P-0.2L-DS	.585	2.125-16UNEF	2.375	.094	.203	1.172	.735	.928	2.625	1.875-16UN	.516	.404
10-107336	36	2.2500-0.1P-0.2L-DS	.585	2.375-16UN	2.625	.094	.203	1.172	.735	1.017	2.875	2.0625-16UN	.516	.404
10-107340	40	2.5000-0.1P-0.2L-DS	.585	2.625-16UN	2.875	.094	.203	1.172	.735	1.104	3.125	2.3125-16UN	.516	.404
10-107344	44	2.7500-0.1P-0.2L-DS	.585	2.875-16UN	3.125	.094	.265	1.234	.922	1.213	3.406	2.625-16UN	.703	.593
10-107348	48	3.0000-0.1P-0.2L-DS	.585	3.125-16UN	3.375	.094	.265	1.234	.922	1.299	3.656	2.875-16UN	.703	.593

\*For complete order number see page 4.

# QWL 10-1074XX

thru bulkhead receptacle



All dimensions for reference only.

Part Number*	Shell Size	A Thread Class 2A	B Min Full Thread	C Ref	G Max Bulkhead Thickness	L ±.015	M +.000 - .010	R ±.005	S ±.020	T Dia +.004 - .003
10-107410	10S	.6250-0.05P-0.1L-DS	.406	.141	.266	1.563	.711	.719	1.000	.120
10-107412	12S	.7500-0.1P-0.2L-DS	.406	.141	.266	1.563	.711	.812	1.094	.120
10-107413	12	.7500-0.1P-0.2L-DS	.625	.155	.312	2.125	.985	.812	1.094	.120
10-107414	14S	.8750-0.1P-0.2L-DS	.406	.141	.266	1.563	.711	.906	1.188	.120
10-107415	14	.8750-0.1P-0.2L-DS	.625	.155	.312	2.125	.985	.906	1.188	.120
10-107416	16S	1.0000-0.1P-0.2L-DS	.406	.141	.266	1.563	.711	.969	1.281	.120
10-107417	16	1.0000-0.1P-0.2L-DS	.625	.155	.312	2.125	.985	.969	1.281	.120
10-107418	18	1.1250-0.1P-0.2L-DS	.625	.155	.312	2.125	.985	1.062	1.375	.120
10-107420	20	1.2500-0.1P-0.2L-DS	.625	.155	.312	2.125	.985	1.156	1.500	.120
10-107422	22	1.3750-0.1P-0.2L-DS	.625	.155	.312	2.125	.985	1.250	1.625	.120
10-107424	24	1.5000-0.1P-0.2L-DS	.625	.155	.312	2.125	.985	1.375	1.750	.147
10-107428	28	1.7500-0.1P-0.2L-DS	.625	.155	.312	2.125	.985	1.562	2.000	.147
10-107432	32	2.0000-0.1P-0.2L-DS	.625	.155	.312	2.125	.985	1.750	2.250	.173
10-107436	36	2.2500-0.1P-0.2L-DS	.625	.155	.312	2.125	.985	1.938	2.500	.173
10-107440	40	2.5000-0.1P-0.2L-DS	.625	.155	.312	2.125	.985	2.188	2.750	.173
10-107444	44	2.7500-0.1P-0.2L-DS	.625	.155	.438	2.375	1.110	2.375	3.000	.209

\*For complete order number see page 4

# QWL 10-1076XX straight plug



All dimensions for reference only.

Part Number*	Shell Size	A Thread Class 2B	B ±.020	D Dia +.010 - .000	G ±.030	J ±.005	N ±.010	Q Dia Max	V Thread (Plated) Class 2A-LH	Z Max
10-107610	10S	.6250-0.05P-0.1L-DS	.406	.735	.053	.531	.563	.882	.500-28UNEF	.603
10-107612	12S	.7500-0.1P-0.2L-DS	.406	.859	.109	.531	.563	1.010	.625-24UNEF	.603
10-107613	12	.7500-0.1P-0.2L-DS	.578	.859	.077	.719	.750	1.010	.625-24UNEF	.852
10-107614	14S	.8750-0.1P-0.2L-DS	.406	.985	.234	.531	.563	1.137	.750-20UNEF	.603
10-107615	14	.8750-0.1P-0.2L-DS	.578	.985	.077	.719	.750	1.137	.750-20UNEF	.852
10-107616	16S	1.0000-0.1P-0.2L-DS	.406	1.109	.234	.531	.563	1.264	.875-20UNEF	.603
10-107617	16	1.0000-0.1P-0.2L-DS	.578	1.109	.141	.719	.750	1.264	.875-20UNEF	.852
10-107618	18	1.1250-0.1P-0.2L-DS	.578	1.235	.266	.719	.750	1.455	1.000-20UNEF	.852
10-107620	20	1.2500-0.1P-0.2L-DS	.578	1.359	.266	.719	.750	1.551	1.1250-18UNEF	.852
10-107622	22	1.3750-0.1P-0.2L-DS	.578	1.485	.266	.719	.750	1.678	1.2500-18UNEF	.852
10-107624	24	1.5000-0.1P-0.2L-DS	.594	1.609	.266	.719	.812	1.806	1.375-18UNEF	.852
10-107628	28	1.7500-0.1P-0.2L-DS	.594	1.859	.266	.719	.812	2.060	1.625-18UNEF	.852
10-107632	32	2.0000-0.1P-0.2L-DS	.594	2.109	.266	.719	.875	2.315	1.875-16UN	.852
10-107636	36	2.2500-0.1P-0.2L-DS	.556†	2.359	.285**	.719	.875	2.569	2.0625-16UNS	.852
10-107640	40	2.5000-0.1P-0.2L-DS	.556†	2.609	.285**	.719	.875	2.824	2.3125-16UNS	.852
10-107644	44	2.7500-0.1P-0.2L-DS	.700††	2.922	.141***	.719	1.000	3.142	2.625-16UN	1.103
10-107648	48	3.0000-0.1P-0.2L-DS	.719	3.172	.141	.719	1.000	3.381	2.875-16UN	1.093

\*For complete order number see page 4

\*\*Applicable Tolerance is ±.033

\*\*\*Applicable Tolerance is +.030

-.020

†Applicable Tolerance is ±.026

††Applicable Tolerance is +.013

-.023

# QWL 10-1077XX flange mount plug



All dimensions for reference only.

Part Number*	Shell Size	A Thread Class 2B	C ±.005	J ±.005	N ±.020	R ±.005	S ±.020	T Thread	Z Max
10-107710	10S	.6250-0.05P-0.1L-DS	.125	.531	.438	.562	.781	4-40 NC	.602
10-107712	12S	.7500-0.1P-0.2L-DS	.156	.531	.438	.812	1.062	4-40 NC	.602
10-107713	12	.7500-0.1P-0.2L-DS	.156	.719	.688	.812	1.062	4-40 NC	.852
10-107714	14S	.8750-0.1P-0.2L-DS	.156	.531	.438	.812	1.062	4-40 NC	.602
10-107715	14	.8750-0.1P-0.2L-DS	.156	.719	.688	.812	1.062	4-40 NC	.852
10-107716	16S	1.0000-0.1P-0.2L-DS	.156	.531	.438	1.000	1.312	6-32 NC	.602
10-107717	16	1.0000-0.1P-0.2L-DS	.156	.719	.688	1.000	1.312	6-32 NC	.852
10-107718	18	1.1250-0.1P-0.2L-DS	.156	.719	.688	1.000	1.312	6-32 NC	.852
10-107720	20	1.2500-0.1P-0.2L-DS	.188	.719	.688	1.250	1.625	10-32 NF	.852
10-107722	22	1.3750-0.1P-0.2L-DS	.188	.719	.688	1.250	1.625	10-32 NF	.852
10-107724	24	1.5000-0.1P-0.2L-DS	.188	.719	.688	1.562	2.000	10-32 NF	.852
10-107728	28	1.7500-0.1P-0.2L-DS	.188	.719	.688	1.562	2.000	10-32 NF	.852
10-107732	32	2.0000-0.1P-0.2L-DS	.250	.719	.781	1.812	2.500	10-32 NF	.852
10-107736	36	2.2500-0.1P-0.2L-DS	.250	.719	.781	1.812	2.500	10-32 NF	.852
10-107740	40	2.5000-0.1P-0.2L-DS	.250	.719	.781	2.250	3.031	10-32 NF	.852
10-107744	44	2.7500-0.1P-0.2L-DS	.250	.719	1.000	2.375	3.031	10-32 NF	.852
10-107748	48	3.0000-0.1P-0.2L-DS	.250	.719	1.000	2.562	3.250	10-32 NF	.852

\*For complete order number see page 4

# QWL

## 10-1079XX

### jam nut receptacle (box mount)

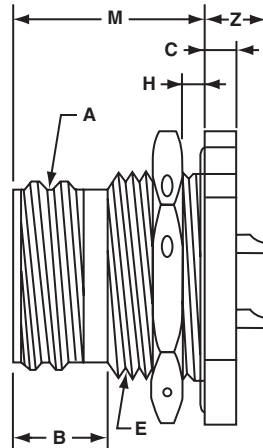
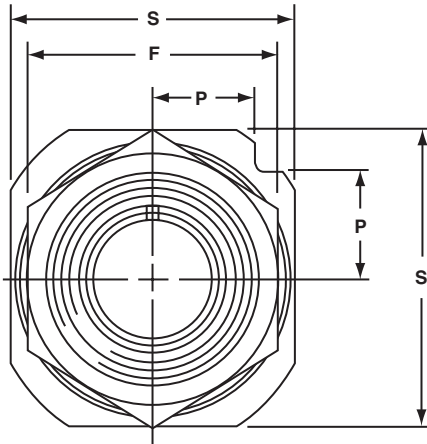

Shell Size	K Dia +.005 -.000	G ±.003	U ±.005
10	.693	.451	.531
12, 13	.880	.518	.625
14, 15	1.005	.562	.688
16, 17	1.130	.606	.750
18	1.255	.699	.875
20	1.380	.739	.938
22	1.505	.783	1.000
24	1.630	.830	1.062
28	1.880	.919	1.188
32	2.130	1.007	1.312
36	2.380	1.096	1.438
40	2.630	1.183	1.562
44	2.880	1.292	1.703
48	3.130	1.378	1.828

mounting dimensions

Mounting dimensions diagram showing a circular component with a hole. Dimension U is the diameter of the hole, G is the diameter of the component, and K is the diameter of the hole. A .125 ±.002 DIA. PIN is shown inserted into the hole.

All dimensions for reference only.

Part Number*	Shell Size	A Thread Class 2A	B ±.010	C ±.005	E Thread Class 2A (Plated)	F Hex ±.016	H Panel Thickness		M ±.010	P ±.010	S ±.010	Z Max
							Min	Max				
10-107910	10S	.6250-0.05P-0.1L-DS	.385	.125	.6875-24NEF	.875	.094	.227	.844	.375	1.062	.295
10-107912	12S	.7500-0.1P-0.2L-DS	.385	.125	.875-20UNEF	1.062	.094	.200	.906	.442	1.250	.232
10-107913	12	.7500-0.1P-0.2L-DS	.585	.125	.875-20UNEF	1.062	.094	.282	1.188	.442	1.250	.389
10-107914	14S	.8750-0.1P-0.2L-DS	.385	.125	1.000-20UNEF	1.250	.094	.200	.906	.486	1.376	.232
10-107915	14	.8750-0.1P-0.2L-DS	.585	.125	1.000-20UNEF	1.250	.094	.282	1.188	.486	1.376	.389
10-107916	16S	1.0000-0.1P-0.2L-DS	.385	.125	1.125-18NEF	1.312	.094	.200	.906	.530	1.500	.232
10-107917	16	1.0000-0.1P-0.2L-DS	.585	.125	1.125-18NEF	1.312	.094	.282	1.188	.530	1.500	.389
10-107918	18	1.1250-0.1P-0.2L-DS	.585	.188	1.250-18NEF	1.500	.094	.250	1.156	.623	1.750	.420
10-107920	20	1.2500-0.1P-0.2L-DS	.585	.188	1.375-18NEF	1.562	.094	.250	1.156	.663	1.875	.420
10-107922	22	1.3750-0.1P-0.2L-DS	.585	.188	1.500-18NEF	1.750	.094	.250	1.156	.707	2.000	.420
10-107924	24	1.5000-0.1P-0.2L-DS	.585	.188	1.625-18NEF	1.875	.094	.312	1.219	.751	2.125	.357
10-107928	28	1.7500-0.1P-0.2L-DS	.585	.188	1.875-16UN	2.125	.094	.312	1.219	.840	2.375	.357
10-107932	32	2.0000-0.1P-0.2L-DS	.585	.219	2.125-16UN	2.375	.094	.282	1.250	.928	2.625	.326
10-107936	36	2.2500-0.1P-0.2L-DS	.585	.219	2.375-16UN	2.625	.094	.282	1.250	1.017	2.875	.326
10-107940	40	2.5000-0.1P-0.2L-DS	.585	.219	2.625-16UN	2.875	.094	.282	1.250	1.104	3.125	.326
10-107944	44	2.7500-0.1P-0.2L-DS	.585	.219	2.875-16UN	3.125	.094	.422	1.390	1.213	3.406	.436
10-107948	48	3.0000-0.1P-0.2L-DS	.585	.219	3.125-16UN	3.375	.094	.422	1.390	1.299	3.656	.436

\*For complete order number see page 4.

# QWL

## insert arrangements - selection guide

Insert Arrangement	Service Rating	Total Contacts	Contact Size				
			0	4	8	12	16
10S-2	A	1					1
12S-3	A	2					2
12S-4	D	1					1
12S-5	D	1				1	
14S-1	A	3					3
14S-2	Inst.	4					4
14S-4	D	1					1
14S-5	Inst.	5					5
14S-6	Inst.	6					6
14S-7	A	3					3
14S-9	A	2					2
14S-10	Inst.	4					4
14S-12	A	3					3
14-3	A	1			1		
16S-1	A	7					7
16S-3	B	1					1
16S-4	D	2					2
16S-5	A	3					3
16S-6	A	3					3
16S-8	A	5					5
16-2	E	1				1	
16-7	A	3			1		2
16-9	A	4				2	2
16-10	A	3				3	
16-11	A	2				2	
16-12	A	1		1			
16-13	A	2				2	
18-1	A/Inst.	10					10
18-3	D	2				2	
18-4	D	4					4
18-5	D	3				2	1
18-6	D	1		1			
18-7	B	1			1		
18-8	A	8				1	7
18-9	Inst.	7				2	5
18-10	A	4				4	
18-11	A	5				5	
18-12	A	6					6
18-13	A	4			1	3	
18-14	A	2		1			1
18-15	A	4				4	
18-16	C	1				1	
18-17	Inst.	7				2	5
18-19	A	10					10
18-20	A	5					5
18-22	D	3					3
18-24	A/Inst.	10					10
18-29	A	5					5
18-30	A	5					5
18-31	A	5					5

Insert Arrangement	Service Rating	Total Contacts	Contact Size				
			0	4	8	12	16
20-2	D	1	1				
20-3	D	3				3	
20-4	D	4				4	
20-6	D	3					3
20-7	D/A	8					8
20-8	Inst.	6			2		4
20-9	D/A	8				1	7
20-11	Inst.	13					13
20-12	A	2		1			1
20-14	A	5			2	3	
20-15	A	7				7	
20-16	A	9				2	7
20-17	A	6				5	1
20-18	A	9				3	6
20-19	A	3			3		
20-20	A	4		1		3	
20-21	A	9				1	8
20-22	A	6			3		3
20-23	A	2			2		
20-24	A	4			2		2
20-25	Inst.	13					13
20-27	A	14					14
20-29	A	17					17
20-30	Inst.	13					13
20-33	A	11					11
22-1	D	2			2		
22-2	D	3			3		
22-4	A	4			2	2	
22-5	D	6				2	4
22-6	D	3			2		1
22-7	E	1	1				
22-8	E	2				2	
22-9	E	3				3	
22-10	E	4					4
22-11	B	2					2
22-12	D	5			2		3
22-13	D/A	5				4	1
22-14	A	19					19
22-15	E/A	6				5	1
22-16	A	9				3	6
22-17	D/A	9				1	8
22-18	D/A	8					8
22-19	A	14					14
22-20	A	9					9
22-21	A	3	1				2
22-22	A	4			4		
22-23	D/A	8				8	
22-24	D/A	6				2	4
22-27	D/A	9			1		8
22-28	A	7				7	



# QWL

## insert arrangements, cont.

Insert Arrangement	Service Rating	Total Contacts	Contact Size				
			0	4	8	12	16
22-33	D/A	7					7
22-34	D	5				3	2
22-36	D/A	8				8	
24-2	D	7				7	
24-3	D	7				2	5
24-5	A	16					16
24-6	D/A	8				8	
24-7	A	16				2	14
24-9	A	2		2			
24-10	A	7			7		
24-11	A	9			3	6	
24-12	A	5		2		3	
24-16	D/A	7			1	3	3
24-17	D	5				2	3
24-20	D	11				2	9
24-21	D	10			1		9
24-22	D	4			4		
24-27	E	7					7
24-28	Inst.	24					24
28-1	D/A	9			3	6	
28-2	D	14				2	12
28-3	E	3			3		
28-4	E/D	9				2	7
28-5	D	5		2		1	2
28-6	D	3		3			
28-7	D	2		2			
28-8	E/D/A	12				2	10
28-9	D	12				6	6
28-10	D/A	7		2	2	3	
28-11	A	22				4	18
28-12	A	26					26
28-13	A	26					26
28-15	A	35					35
28-16	A	20					20
28-17	B/D/A	15					15
28-18	C/D/A/Inst.	12					12
28-19	B/D/A	10				4	6
28-20	A	14				10	4
28-21	A	37					37
28-22	D	6		3			3

Insert Arrangement	Service Rating	Total Contacts	Contact Size				
			0	4	8	12	16
32-1	E/D	5	2			3	
32-2	E	5		3			2
32-3	D	9	1	2		2	4
32-4	A/D	14				2	12
32-5	D	2	2				
32-6	A	23		2	3	2	16
32-7	Inst./A	35				7	28
32-8	A	30				6	24
32-9	D	14		2			12
32-10	E/B/D/A	7		2	2		3
32-12	A/D	15				5	10
32-13	D	23				5	18
32-15	D	8	2			6	
32-16	A	23		2	3	2	16
32-17	D	4		4			
32-22	A	54					54
36-1	D	22				4	18
36-3	D	6	3			3	
36-4	D/A	3	3				
36-5	A	4	4				
36-6	A	6	2	4			
36-7	A	47				7	40
36-8	A	47				1	46
36-9	A	31		1	2	14	14
36-10	A	48					48
36-11	A	48					48
36-12	A	48					48
36-13	E/A	17				2	15
36-14	D	16			5	5	6
36-15	D/A	35					35
36-16	A	47				7	40
36-17	A	47				7	40
36-18	A	31		1	2	14	14
36-20	A	34			2	2	30
36-52	A	52					52
40-1	D	30				6	24
40-9	A	47			1	22	24
40-56	A	85					85
48-62	D	85					85

# QWL special insert arrangements

Insert Arrangement	Service Rating	Total Contacts	Contact Size														
			4/0	2/0	0	4	8	12	16	Coax**							
										0	4	8	12				
14S-A7	A	7										7					
16-59	A	4								4							
20-26	A	19										19					
20-51	A	3						3									
20-57	A	7							7*								
20-58	A	10							5	5							
20-59	A	3						3*									
20-66	A	6							5*	1							
20-79	A/D	8							1	7							
22-63	A	12							4	8							
22-65	A/D	8							8*								
22-70	A	13							8	5							
22-80	A	3						3*									
24-19	A	12										12					
24-51	A	5						5									
24-52	Hi Volt.	1							1								
24-53	A	5						5									
24-58	A	13						3	3	7							
24-59	A	14							7	7							
24-60	A	7						7*									
24-65	A	15							11	4							
24-66	D	7							7								
24-67	Inst.	19								19							
24-71	A	7						7*									
24-75	A	7						7*									
24-79	A	5						5									
24-80	Inst.	23										23					
24-84	A	19								1						18	
24-96	Inst.	28										28					
24-AJ	A	25										25					
28-51	A	12								12							
28-59	A	17							7	10							
28-66	A	16						2	14								
28-72	Coax	3											3				
28-74	A	16						7*		9							
28-75	A	16						7*		9							
28-79	A	16						7		9							
28-82	D	6						2	4								
28-84	A	9						9									
28-AY	A	9					4					5					
32-25	A	25								25							
32-31	A	31										31					
32-48	Inst.	48										48					
32-52	D	8				2			6								
32-53	Inst./E	42							5	37							
32-56	A	30							6*	24							
32-57	Coax	8							6		2						
32-58	Coax	4										4					
32-60	A	23								15			8				
32-62	Coax	23					2	1	2	16			2				
32-64	Inst.	54								54							
32-68	A	16								12		4					
32-73	A	46								46							
32-75	Coax	9							2				7				
32-76	A	19								19							
32-79	D	5					4	1									
32-82	A	16					4				12						

Insert Arrangement	Service Rating	Total Contacts	Contact Size														
			4/0	2/0	0	4	8	12	16	Coax**							
										0	4	8	12				
32-AF	A	55											55				
36-51	D	4				2	2										
36-54	A	39								8			31				
36-55	A	39								8*			31				
36-59	A	53										3*	50				
36-60	A	47										7*	40				
36-64	Coax	4												4			
36-65	Coax	4												4			
36-71	A	53										3	50				
36-73	Coax	7													7		
36-74	A	44											43			1	
36-75	A	48											48*				
36-76	A	47											47				
36-77	D	7					7										
36-78	A	14								12			2				
36-79	A	20										20					
36-80	A	20										20*					
36-83	Coax	7													7		
36-85	A/D	35											35*				
36-97	C	1	1														
36-AF	A	48											48				
40-5	A	5								5							
40-10	A	29								4	9		16				
40-35	D	35											35				
40-53	A	60											60				
40-57	E	4				4											
40-61	A	59									1	3	55				
40-62	A	60											60				
40-63	A	61											61*				
40-64	Coax	36										3	20			13	
40-66	Coax	4												4			
40-67	A	11											1		10		
40-68	A	21									21						
40-70	A	61											61				
40-72	A	11											1		10		
40-73	A	61											61				
40-74	A	6										1		4	1		
40-75	E	5				4						1					
40-80	A	11								10			1				
40-81	A	62											62*				
40-82	A	62											62				
40-85	A	60											60*				
40-86	E	4												4			
40-87	D	7								7							
40-AD	A	8								4		4					
40-AG	A	38											38				
40-AP	E	2	2														
40-AR	Inst.	13								3	3		7				
40-AS	A	40											25	15			
40-AT	A	43										1	24	18			
40-AU	A	14									3	10		1			
40-AV	D	3				3											
44-52	A	104												104			
44-53	A	36												18		18	
48-51	A	56										10		42	4		
48-52	A	61												56	5		
48-53	D	37											37				
48-54	A	56										10		42	4		
48-55	A	78										6	2	2	68		
48-57	A	56									4		10	42			
48-60	A	56											10	42	4		

\* Crimp contacts accommodate wire the same size as the contact as well as wire of the next smaller, even size. Arrangements identified with an asterisk (\*) are exceptions. See insert arrangement drawings on pages 18-40 for application wire size.

\*\* Coaxial cable data can be found on insert arrangement drawings, pages 38-48. For further information on coaxial contacts and cable see catalog 12-130. Consult Sidney, NY for alternate rotations not covered on page 17.

# QWL alternate positioning

To avoid cross-plugging problems in applications requiring the use of more than one connector of the same size and arrangement, alternate rotations are available as indicated in the accompanying charts.

As shown in the diagram below, the front face of the pin insert is rotated within the shell in a clockwise direction from the normal shell key. The socket insert would be rotated counter-clockwise the same number of degrees in respect to the normal shell key.

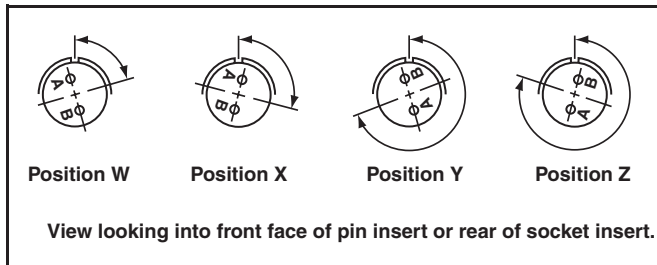

The following insert arrangements have the same alternate insert rotations for W, X, Y and Z, which are:

Degrees			
W	X	Y	Z
80	110	250	280

16-7	20-22	22-29	24-17	28-16	32-13
18-5	22-6	22-33	24-20	28-17	32-22
18-9	22-12	22-34	24-21	28-19	32-AF
18-13	22-14	24-1	24-28	28-20	36-1
18-14	22-15	24-3	28-1	28-21	36-7
20-7	22-16	24-4	28-4	32-1	36-8
20-8	22-17	24-5	28-8	32-3	36-13
20-9	22-18	24-6	28-9	32-4	40-AR
20-12	22-19	24-7	28-10	32-6	40-AS
20-14	22-21	24-12	28-11	32-9	40-AT
20-16	22-24	24-14	28-14	32-10	40-AU
20-20	22-25	24-16	28-15	32-12	

Insert Arrangement	Degrees			
	W	X	Y	Z
10SL-4	63	-	-	-
12S-3	70	145	215	290
14S-2	-	120	240	-
14S-5	-	110	-	-
14S-7	90	180	270	-
14S-9	70	145	215	290
16-9	35	110	250	325
16-10	90	180	270	-
16-11	35	110	250	325
16-13	35	110	250	325
16S-1	80	-	-	280
16S-4	35	110	250	325
16S-5	70	145	215	290
16S-6	90	180	270	-
16S-8	-	170	265	-
18-1	70	145	215	290
18-3	35	110	250	325
18-4	35	110	250	325
18-8	70	-	-	290
18-10	-	120	240	-
18-11	-	170	265	-
18-12	80	-	-	280
18-15	-	120	240	-
18-20	90	180	270	-
18-22	70	145	215	290
18-29	90	180	270	-
20-3	70	145	215	290
20-4	45	110	250	-
20-5	35	110	250	325
20-6	70	145	215	290
20-15	80	-	-	280
20-17	90	180	270	-

Insert Arrangement	Degrees			
	W	X	Y	Z
20-18	35	110	250	325
20-19	90	180	270	-
20-21	35	110	250	325
20-23	35	110	250	325
20-24	35	110	250	325
20-27	35	110	250	325
20-29	80	-	-	280
22-1	35	110	250	325
22-2	70	145	215	290
22-4	35	110	250	325
22-5	35	110	250	325
22-8	35	110	250	325
22-9	70	145	215	290
22-10	35	110	250	325
22-11	35	110	250	325
22-13	35	110	250	325
22-20	35	110	250	325
22-22	-	110	250	-
22-23	35	-	250	-
22-27	80	-	250	280
22-28	80	-	-	280
22-63	20	-	-	-
24-2	80	-	-	280
24-9	35	110	250	325
24-10	80	-	-	280
24-11	35	110	250	325
24-22	45	110	250	-
24-27	80	-	-	280
28-2	35	110	250	325
28-3	70	145	215	290
28-5	35	110	250	325
28-6	70	145	215	290

Insert Arrangement	Degrees			
	W	X	Y	Z
28-7	35	110	250	325
28-12	90	180	270	-
28-18	70	145	215	290
28-22	70	145	215	290
28-AY	45	110	250	-
32-2	70	145	215	290
32-5	35	110	250	325
32-7	80	125	235	280
32-8	80	125	235	280
32-15	35	110	250	280
32-17	45	110	250	-
32-25	60	120	-	-
32-48	80	-	-	-
32-64	80	100	110	250
32-68	30	-	-	-
32-82	30	-	-	-
36-3	70	145	215	290
36-4	70	145	215	290
36-5	-	120	240	-
36-6	35	110	250	325
36-9	80	125	235	280
36-10	80	125	235	280
36-14	90	180	270	-
36-15	60	125	245	305
36-AF	65	-	-	-
40-1	65	130	235	300
40-5	33	-	-	270
40-9	65	125	225	310
40-10	65	125	225	310
40-35	70	130	230	290
40-AD	45	-	-	-
40-AG	37	74	285	322
40-AP	35	110	250	325
40-AV	90	180	270	-

# QWL

## contact arrangements

front face of pin insert or rear face of socket insert illustrated

<b>Insert Arrangement</b>	<b>10S-2</b>	<b>12S-3</b>	<b>12S-4</b>	<b>12-5</b>	<b>14S-1</b>	<b>14S-2</b>
<b>Service Rating</b>	<b>A</b>	<b>A</b>	<b>A</b>	<b>D</b>	<b>A</b>	<b>Inst.</b>
<b>Number of Contacts</b>	<b>1</b>	<b>2</b>	<b>1</b>	<b>1</b>	<b>3</b>	<b>4</b>
<b>Contact Size</b>	<b>16</b>	<b>16</b>	<b>16</b>	<b>12</b>	<b>16</b>	<b>16</b>

<b>Insert Arrangement</b>	<b>14S-4</b>	<b>14S-5</b>	<b>14S-6</b>	<b>14S-7</b>	<b>14S-9</b>	<b>14S-10</b>
<b>Service Rating</b>	<b>D</b>	<b>Inst.</b>	<b>Inst.</b>	<b>A</b>	<b>A</b>	<b>Inst.</b>
<b>Number of Contacts</b>	<b>1</b>	<b>5</b>	<b>6</b>	<b>3</b>	<b>2</b>	<b>4</b>
<b>Contact Size</b>	<b>16</b>	<b>16</b>	<b>16</b>	<b>16</b>	<b>16</b>	<b>16</b>

<b>Insert Arrangement</b>	<b>14S-12</b>	<b>14-3</b>	<b>16S-1</b>	<b>16S-3</b>	<b>16S-4</b>	<b>16S-5</b>
<b>Service Rating</b>	<b>A</b>	<b>A</b>	<b>A</b>	<b>B</b>	<b>D</b>	<b>A</b>
<b>Number of Contacts</b>	<b>3</b>	<b>1</b>	<b>7</b>	<b>1</b>	<b>2</b>	<b>3</b>
<b>Contact Size</b>	<b>16</b>	<b>8</b>	<b>16</b>	<b>16</b>	<b>16</b>	<b>16</b>

<b>Insert Arrangement</b>	<b>16S-6</b>	<b>16S-8</b>	<b>16-2</b>	<b>16-7</b>	<b>16-9</b>
<b>Service Rating</b>	<b>A</b>	<b>A</b>	<b>E</b>	<b>A</b>	<b>A</b>
<b>Number of Contacts</b>	<b>3</b>	<b>5</b>	<b>1</b>	<b>1 2</b>	<b>2 2</b>
<b>Contact Size</b>	<b>16</b>	<b>16</b>	<b>12</b>	<b>8 16</b>	<b>12 16</b>

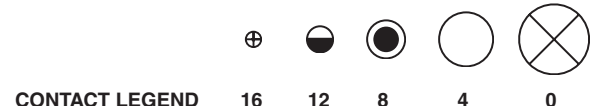

# QWL contact arrangements

front face of pin insert or rear face of socket insert illustrated

<b>Insert Arrangement</b>	<b>16-10</b>	<b>16-11</b>	<b>16-12</b>	<b>16-13</b>	<b>18-1</b>	<b>18-3</b>
<b>Service Rating</b>	<b>A</b>	<b>A</b>	<b>A</b>	<b>A</b>	<b>B, C, F, G = A; Bal. = Inst.</b>	<b>D</b>
<b>Number of Contacts</b>	<b>3</b>	<b>2</b>	<b>1</b>	<b>2*</b>	<b>10</b>	<b>2</b>
<b>Contact Size</b>	<b>12</b>	<b>12</b>	<b>4</b>	<b>12</b>	<b>16</b>	<b>12</b>
<b>Insert Arrangement</b>	<b>18-4</b>	<b>18-5</b>	<b>18-6</b>	<b>18-7</b>	<b>18-8</b>	<b>18-9</b>
<b>Service Rating</b>	<b>D</b>	<b>D</b>	<b>D</b>	<b>B</b>	<b>A</b>	<b>Inst.</b>
<b>Number of Contacts</b>	<b>4</b>	<b>2 1</b>	<b>1</b>	<b>1</b>	<b>1 7</b>	<b>2 5</b>
<b>Contact Size</b>	<b>16</b>	<b>12 16</b>	<b>4</b>	<b>8</b>	<b>12 16</b>	<b>12 16</b>
<b>Insert Arrangement</b>	<b>18-10</b>	<b>18-11</b>	<b>18-12</b>	<b>18-13</b>	<b>18-14</b>	<b>18-15</b>
<b>Service Rating</b>	<b>A</b>	<b>A</b>	<b>A</b>	<b>A</b>	<b>A</b>	<b>A</b>
<b>Number of Contacts</b>	<b>4</b>	<b>5</b>	<b>6</b>	<b>1 3</b>	<b>1 1</b>	<b>4**</b>
<b>Contact Size</b>	<b>12</b>	<b>12</b>	<b>16</b>	<b>8 12</b>	<b>4 16</b>	<b>12</b>
<b>Insert Arrangement</b>	<b>18-16</b>	<b>18-17</b>	<b>18-19</b>	<b>18-20</b>	<b>18-22</b>	<b>18-24</b>
<b>Service Rating</b>	<b>C</b>	<b>Inst.</b>	<b>A</b>	<b>A</b>	<b>D</b>	<b>B, C, F, G = A; Bal. = Inst.</b>
<b>Number of Contacts</b>	<b>1</b>	<b>2 5</b>	<b>10</b>	<b>5</b>	<b>3</b>	<b>10</b>
<b>Contact Size</b>	<b>12</b>	<b>12 16</b>	<b>16</b>	<b>16</b>	<b>16</b>	<b>16</b>

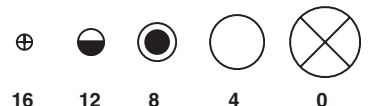

\* A = Iron; B = Constantan  
\*\* A, C = Iron; B, D = Constantan

# QWL contact arrangements

front face of pin insert or rear face of socket insert illustrated

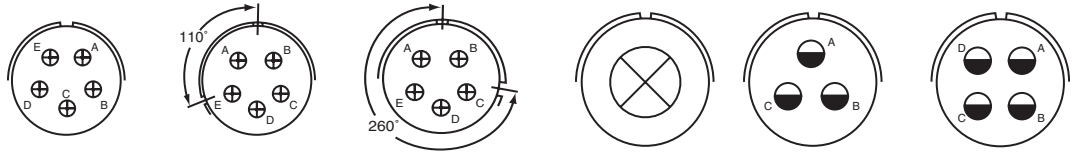

Insert Arrangement	18-29	18-30	18-31	20-2	20-3	20-4
Service Rating	A	A	A	D	D	D
Number of Contacts	5	5	5	1	3	4
Contact Size	16	16	16	0	12	12

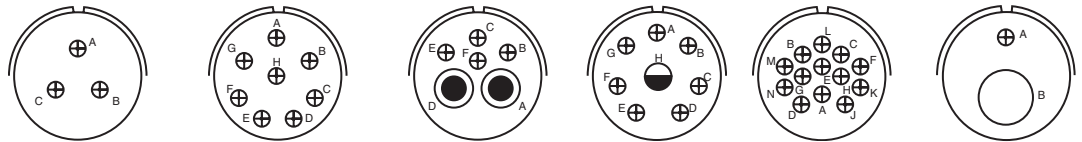

Insert Arrangement	20-6	20-7	20-8	20-9	20-11	20-12
Service Rating	D	A, B, H, G = D; C, D, E, F = A	Inst.	H = D; Bal. = A	Inst.	A
Number of Contacts	3	8	2 4	1 7	13	1 1
Contact Size	16	16	8 16	12 16	16	4 16



Insert Arrangement	20-14	20-15	20-16	20-17	20-18	20-19
Service Rating	A	A	A	A	A	A
Number of Contacts	2 3	7	2 7	5 1	3 6	3
Contact Size	8 12	12	12 16	12 16	12 16	8



CONTACT LEGEND 16 12 8 4 0

# QWL contact arrangements

front face of pin insert or rear face of socket insert illustrated

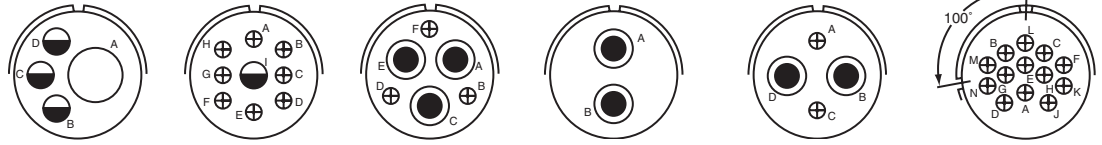

Insert Arrangement	20-20	20-21	20-22	20-23	20-24	20-25
Service Rating	A	A	A	A	A	Inst.
Number of Contacts	1 3	1 8	3 3	2	2 2	13
Contact Size	4 12	12 16	8 16	8	8 16	16

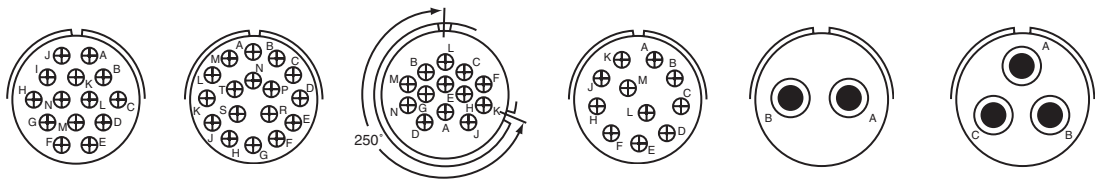

Insert Arrangement	20-27	20-29	20-30	20-33	22-1	22-2
Service Rating	A	A	Inst.	A	D	D
Number of Contacts	14	17	13	11	2	3
Contact Size	16	16	16	16	8	8

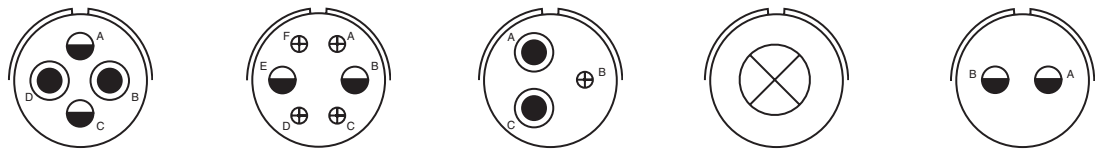

Insert Arrangement	22-4	22-5	22-6	22-7	22-8
Service Rating	A	D	D	E	E
Number of Contacts	2 2	2 4	2 1	1	2
Contact Size	8 12	12 16	8 16	0	12

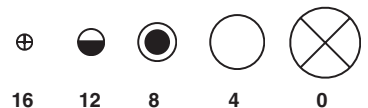



# QWL contact arrangements

front face of pin insert or rear face of socket insert illustrated

<b>Insert Arrangement</b>	<b>22-9</b>	<b>22-10</b>	<b>22-11</b>	<b>22-12</b>	<b>22-13</b>
<b>Service Rating</b>	<b>E</b>	<b>E</b>	<b>B</b>	<b>D</b>	<b>E = D; A, B, C, D = A</b>
<b>Number of Contacts</b>	<b>3</b>	<b>4</b>	<b>2</b>	<b>2 3</b>	<b>4 1</b>
<b>Contact Size</b>	<b>12</b>	<b>16</b>	<b>16</b>	<b>8 16</b>	<b>12 16</b>

<b>Insert Arrangement</b>	<b>22-14</b>	<b>22-15</b>	<b>22-16</b>	<b>22-17</b>	<b>22-18</b>
<b>Service Rating</b>	<b>A</b>	<b>D = E; A, B, C, E, F = A</b>	<b>A</b>	<b>A = D; Bal. = A</b>	<b>A, B, F, G, H = D; C, D, E = A</b>
<b>Number of Contacts</b>	<b>19</b>	<b>5 1</b>	<b>3 6</b>	<b>1 8</b>	<b>8</b>
<b>Contact Size</b>	<b>16</b>	<b>12 16</b>	<b>12 16</b>	<b>12 16</b>	<b>16</b>

<b>Insert Arrangement</b>	<b>22-19</b>	<b>22-20</b>	<b>22-21</b>	<b>22-22</b>	<b>22-23</b>
<b>Service Rating</b>	<b>A</b>	<b>A</b>	<b>A</b>	<b>A</b>	<b>H = D; Bal. = A</b>
<b>Number of Contacts</b>	<b>14</b>	<b>9</b>	<b>1 2</b>	<b>4</b>	<b>8</b>
<b>Contact Size</b>	<b>16</b>	<b>16</b>	<b>0 16</b>	<b>8</b>	<b>12</b>

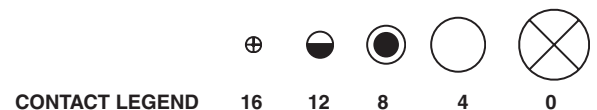

# QWL contact arrangements

front face of pin insert or rear face of socket insert illustrated

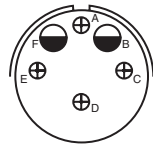

**22-24**  
**Service Rating** C, D, E = D; A, B, F = A  
**Number of Contacts** 2 4  
**Contact Size** 12 16

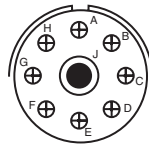

**22-27**  
**Service Rating** J = D; Bal. = A  
**Number of Contacts** 1 8  
**Contact Size** 8 16

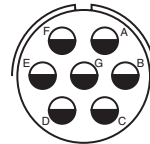

**22-28**  
**Service Rating** A  
**Number of Contacts** 7  
**Contact Size** 12

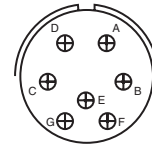

**22-33**  
**Service Rating** A, B, C, D = D; E, F, G = A  
**Number of Contacts** 7  
**Contact Size** 16

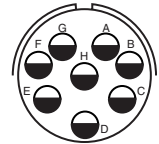

**22-36**  
**Service Rating** H = D; Bal. = A\*  
**Number of Contacts** 8  
**Contact Size** 12

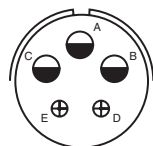

**22-34**  
**Service Rating** D  
**Number of Contacts** 3 2  
**Contact Size** 12 16

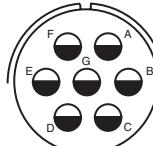

**24-2**  
**Service Rating** D  
**Number of Contacts** 7  
**Contact Size** 12

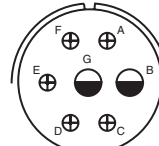

**24-3**  
**Service Rating** D  
**Number of Contacts** 2 5  
**Contact Size** 12 16

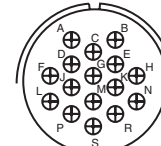

**24-5**  
**Service Rating** A  
**Number of Contacts** 16  
**Contact Size** 16

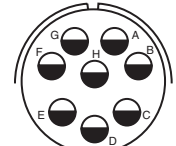

**24-6**  
**Service Rating** A, G, H = D; Bal. = A  
**Number of Contacts** 8  
**Contact Size** 12

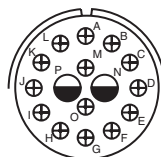

**24-7**  
**Service Rating** A  
**Number of Contacts** 2 14  
**Contact Size** 12 16

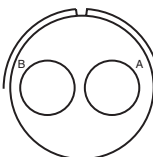

**24-9**  
**Service Rating** A  
**Number of Contacts** 2  
**Contact Size** 4

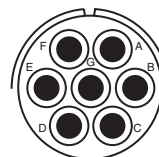

**24-10**  
**Service Rating** A  
**Number of Contacts** 7  
**Contact Size** 8

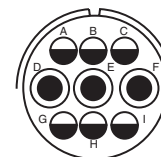

**24-11**  
**Service Rating** A  
**Number of Contacts** 3 6  
**Contact Size** 8 12

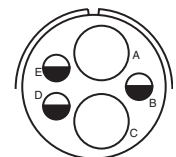

**24-12**  
**Service Rating** A  
**Number of Contacts** 2 3  
**Contact Size** 4 12

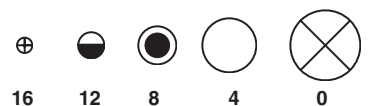

**CONTACT LEGEND**

16

12

8

4

0

\* A, C, E, G = Iron  
 B, D, F, H = Constantan

# QWL contact arrangements

front face of pin insert or rear face of socket insert illustrated

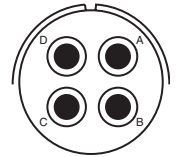
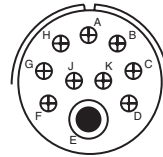
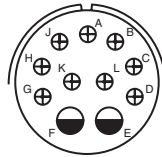
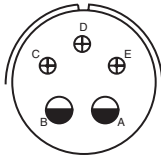
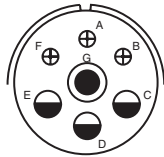

Insert Arrangement	24-16		
Service Rating	A, B, F, G = D; C, D, E, = A		
Number of Contacts	1	3	3
Contact Size	8	12	16

Insert Arrangement	24-17	
Service Rating	D	
Number of Contacts	2	3
Contact Size	12	16

Insert Arrangement	24-20		
Service Rating	D		
Number of Contacts	2	9	
Contact Size	12	16	

Insert Arrangement	24-21		
Service Rating	D		
Number of Contacts	1	9	
Contact Size	8	16	

Insert Arrangement	24-22		
Service Rating	D		
Number of Contacts	4		
Contact Size	8		

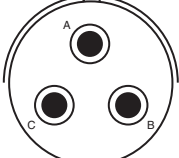
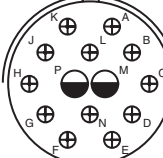
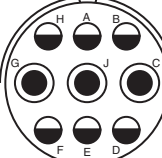
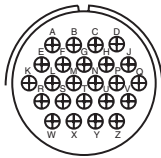
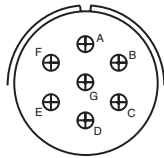

Insert Arrangement	24-27	
Service Rating	E	
Number of Contacts	7	
Contact Size	16	

Insert Arrangement	24-28		
Service Rating	Inst.		
Number of Contacts	24		
Contact Size	16		

Insert Arrangement	28-1		
Service Rating	A, J, E = D; Bal. = A		
Number of Contacts	3	6	
Contact Size	8	12	

Insert Arrangement	28-2		
Service Rating	D		
Number of Contacts	2	12	
Contact Size	12	16	

Insert Arrangement	28-3		
Service Rating	E		
Number of Contacts	3		
Contact Size	8		

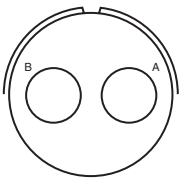
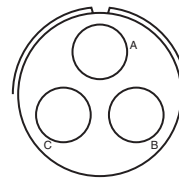
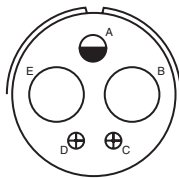
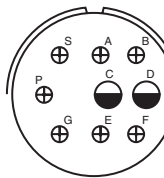

Insert Arrangement	28-4	
Service Rating	G, P, S = E; Bal. = D	
Number of Contacts	2	7
Contact Size	12	16

Insert Arrangement	28-5		
Service Rating	D		
Number of Contacts	2	1	2
Contact Size	4	12	16

Insert Arrangement	28-6		
Service Rating	D		
Number of Contacts	3		
Contact Size	4		

Insert Arrangement	28-7		
Service Rating	D		
Number of Contacts	2		
Contact Size	4		



# QWL contact arrangements

front face of pin insert or rear face of socket insert illustrated

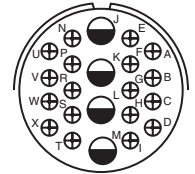
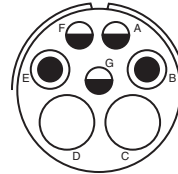
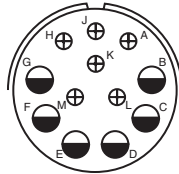
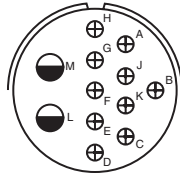

<b>Insert Arrangement</b>	<b>28-8</b>
<b>Service Rating</b>	L, M = E; B = D; Bal. = A
<b>Number of Contacts</b>	2 10
<b>Contact Size</b>	12 16

<b>28-9</b>
D
6 6
12 16

<b>28-10</b>
G = D; Bal. = A
2 2 3
4 8 12

<b>28-11</b>
A
4 18
12 16

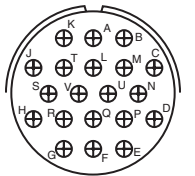
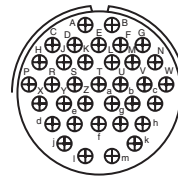
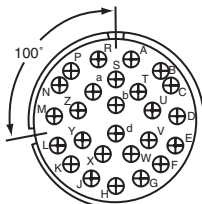
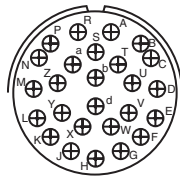

<b>Insert Arrangement</b>	<b>28-12</b>
<b>Service Rating</b>	A
<b>Number of Contacts</b>	26
<b>Contact Size</b>	16

100° Rotation  
of 28-12

<b>28-13</b>
A
26
16

<b>28-15</b>
A
35
16

<b>28-16</b>
A
20
16

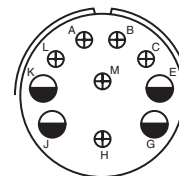
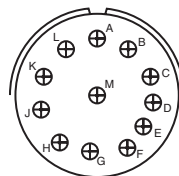
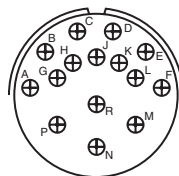

<b>Insert Arrangement</b>	<b>28-17</b>
<b>Service Rating</b>	R = B; M, N, P = D; A to L = A
<b>Number of Contacts</b>	15
<b>Contact Size</b>	16

<b>28-18</b>
M = C; G, H, J, K, L = D; A, B = A; Bal. = Inst.
12
16

<b>28-19</b>
H, M = B; A, B = D; Bal. = A
4 6
12 16



# QWL contact arrangements

front face of pin insert or rear face of socket insert illustrated

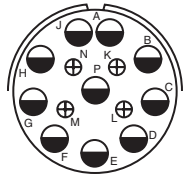

**28-20**

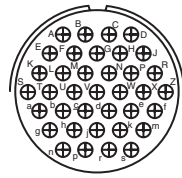

**28-21**

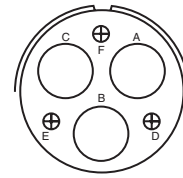

**28-22**

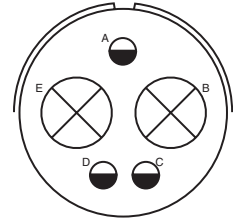

**32-1**

**Insert Arrangement**  
**Service Rating**  
**Number of Contacts**  
**Contact Size**

**A**  
**10 4**  
**12 16**

**A**  
**37**  
**16**

**D**  
**3 3**  
**4 16**

**A = E; B, C, D, E = D**  
**2 3**  
**0 12**

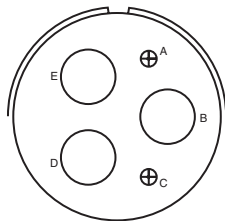

**32-2**

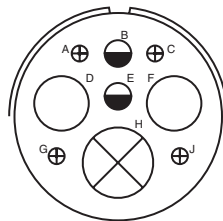

**32-3**

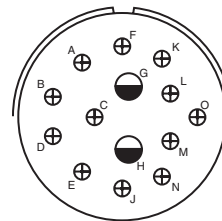

**32-4**

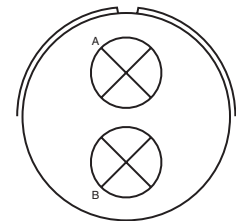

**32-5**

**Insert Arrangement**  
**Service Rating**  
**Number of Contacts**  
**Contact Size**

**E**  
**3 2**  
**4 16**

**D**  
**1 2 2 4**  
**0 4 12 16**

**F, J, K, N = A; Bal. = D**  
**2 12**  
**12 16**

**D**  
**2**  
**0**

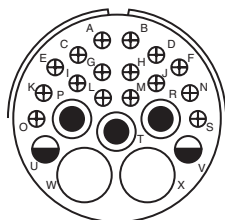

**32-6**

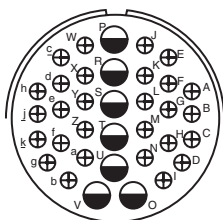

**32-7**

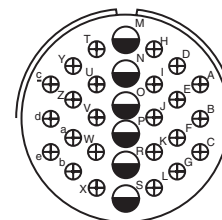

**32-8**

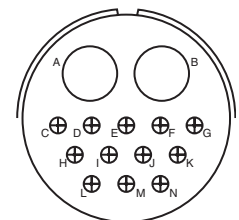

**32-9**

**Insert Arrangement**  
**Service Rating**  
**Number of Contacts**  
**Contact Size**

**A**  
**2 3 2 16**  
**4 8 12 16**

**A, B, h, j = Inst.; Bal. = A**  
**7 28**  
**12 16**

**A**  
**6 24**  
**12 16**

**D**  
**2 12**  
**4 16**



**CONTACT LEGEND**

**16 12 8 4 0**

# QWL contact arrangements

front face of pin insert or rear face of socket insert illustrated

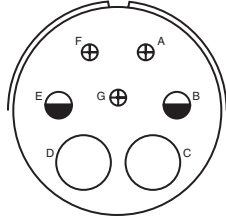

32-10

Insert Arrangement

Service Rating

Number of Contacts

Contact Size

A, F = E; G = B; B, E = D; C, D = A

2 2 3

4 8 16

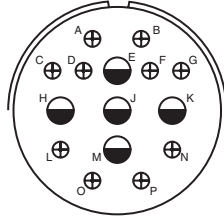

32-12

C, D, E, F, G = A; Bal. = D

5 10

12 16

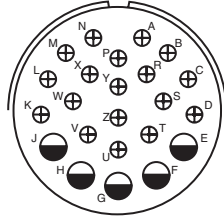

32-13

D

5 18

12 16

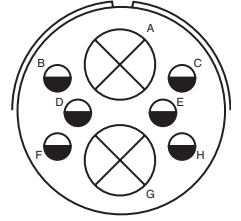

32-15

D

2 6

0 12

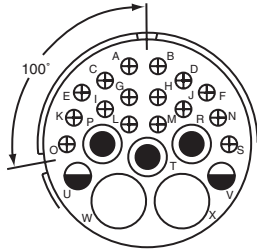

100° Rotation  
of 32-6

32-16

Insert Arrangement

Service Rating

Number of Contacts

Contact Size

A

2 3 2 16

4 8 12 16

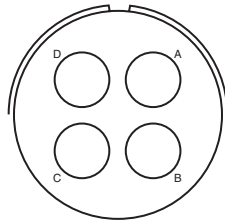

32-17

D

4

4

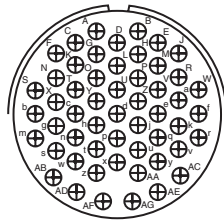

32-22

A

54

16

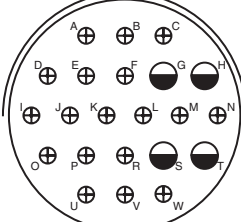

36-1

D

4 18

12 16

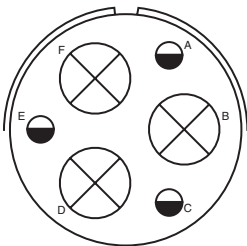

36-3

Insert Arrangement

Service Rating

Number of Contacts

Contact Size

D

3 3

0 12

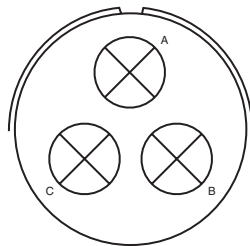

36-4

A = D; B, C = A

3

0

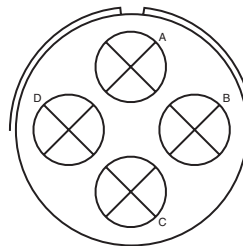

36-5

A

4

0

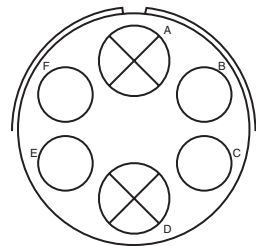

36-6

A

2 4

0 4



# QWL contact arrangements

front face of pin insert or rear face of socket insert illustrated

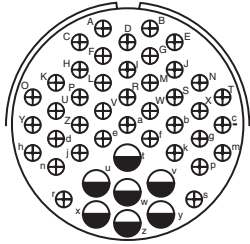

Insert Arrangement	36-7
Service Rating	A
Number of Contacts	7 40
Contact Size	12 16

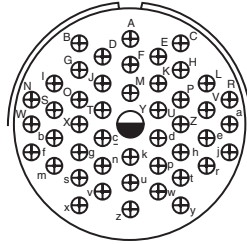

Insert Arrangement	36-8
Service Rating	A
Number of Contacts	1 46
Contact Size	12 16

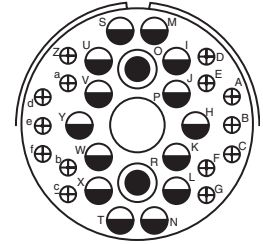

Insert Arrangement	36-9
Service Rating	A
Number of Contacts	1 2 14 14
Contact Size	4 8 12 16

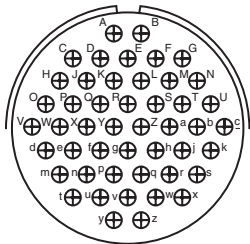

Insert Arrangement	36-10
Service Rating	A
Number of Contacts	48
Contact Size	16

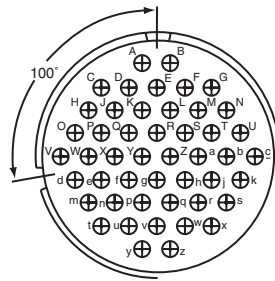

Insert Arrangement	36-11
Service Rating	A
Number of Contacts	48
Contact Size	16

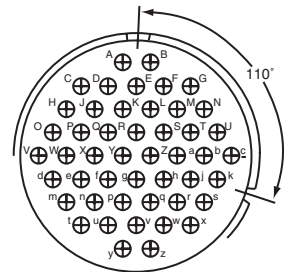

Insert Arrangement	36-12
Service Rating	A
Number of Contacts	48
Contact Size	16

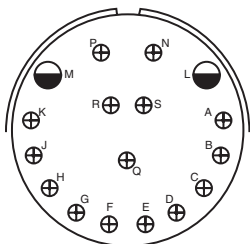

Insert Arrangement	36-13
Service Rating	N, P, Q = E; Bal. = A
Number of Contacts	2 15
Contact Size	12 16

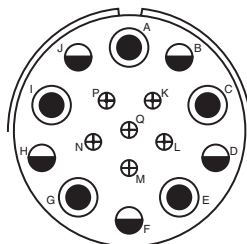

Insert Arrangement	36-14
Service Rating	D
Number of Contacts	5 5 6
Contact Size	8 12 16

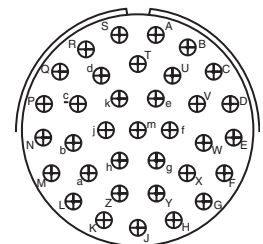

Insert Arrangement	36-15
Service Rating	M = D; Bal. = A
Number of Contacts	35
Contact Size	16

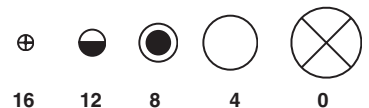

CONTACT LEGEND

16 12 8 4 0



# QWL contact arrangements

front face of pin insert or rear face of socket insert illustrated

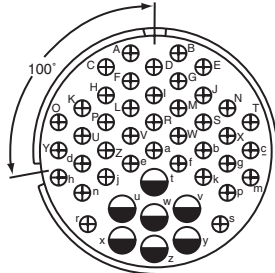

100° Rotation  
of 36-7

**36-16**

**Insert Arrangement**  
**Service Rating**  
**Number of Contacts**  
**Contact Size**

**A**  
**7 40**  
**12 16**

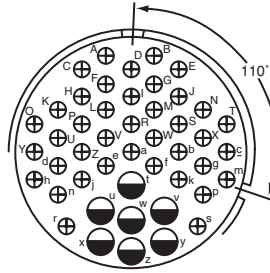

110° Rotation  
of 36-7

**36-17**

**A**  
**7 40**  
**12 16**

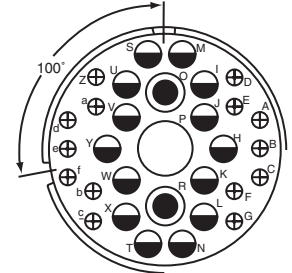

100° Rotation  
of 36-9

**36-18**

**A**  
**1 2 14 14**  
**4 8 12 16**

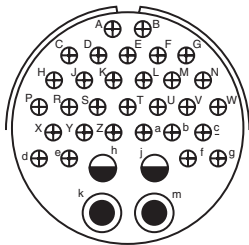

**36-20**

**Insert Arrangement**  
**Service Rating**  
**Number of Contacts**  
**Contact Size**

**A**  
**2 2 30**  
**8 12 16**

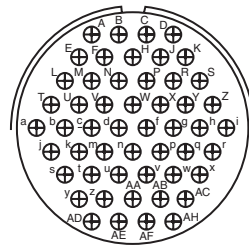

**36-52**

**A**  
**52**  
**16**

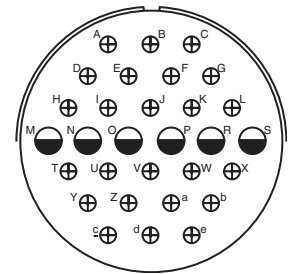

**40-1**

**D**  
**6 24**  
**12 16**

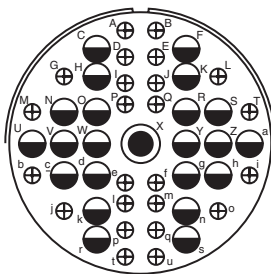

**40-9**

**Insert Arrangement**  
**Service Rating**  
**Number of Contacts**  
**Contact Size**

**A**  
**1 22 24**  
**8 12 16**

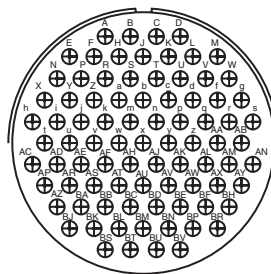

**40-56**

**A**  
**85**  
**16**

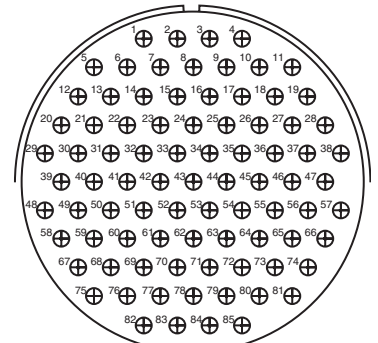

**48-62**

**D**  
**85**  
**16**



**CONTACT LEGEND**

**16 12 8 4 0**

# Special contact arrangements

Requirements for more complex circuits prompted Amphenol to provide inserts not covered by the MS drawings. Illustrated here and on the following pages are insert layouts which have from one contact (high tension) to the 104 contact insert in shell size 44.

Many of these special inserts are also available in alternate keyway arrangements. Please contact Amphenol, Sidney, NY for additional information on special circuit application requirements.

front face of pin insert or rear face of socket insert illustrated

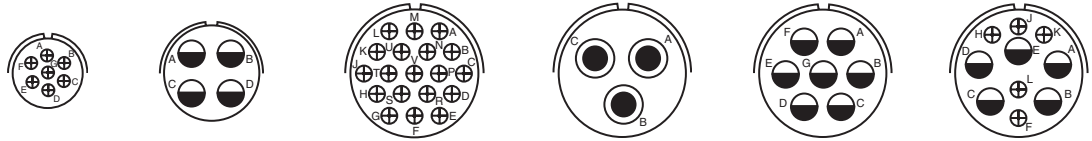

Insert Arrangement	14S-A7	16-59	20-26	20-51	20-57	20-58
Service Rating	A	A	A	A	A	A
Number of Contacts	7	4	19	3*	7*	5 5
Contact Size	16	12	16	8	12 for #14 or 16 wire	12 16

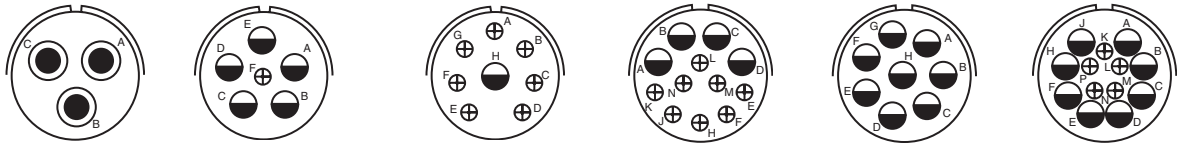

Insert Arrangement	20-59	20-66	20-79	22-63	22-65	22-70
Service Rating	A	A	H = D; Bal. = A	A	H = D; Bal. = A	A
Number of Contacts	3*	1 5	7* 1*	4 8	8*	8 5
Contact Size	8 for #10 or 12 wire	16 12 for #10 wire	16 12 for #16 wire	12 16	12 for #14 or 16 wire	12 16

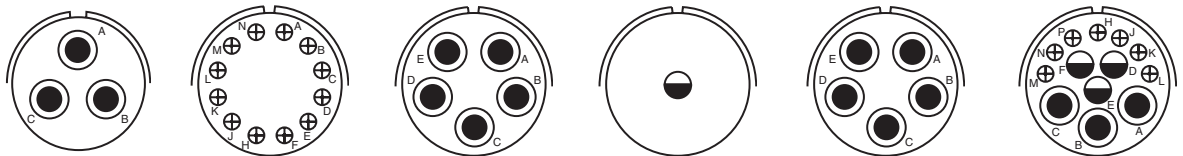

Insert Arrangement	22-80	24-19	24-51	24-52	24-53	24-58
Service Rating	A	A	A	Hi-Volt	A	A
Number of Contacts	3*	12	5*	1	5*	3 3 7
Contact Size	8 for #10 or 12 wire	16	B, E for AN #10 or 12 wire A, C, D for AN #8 wire	12	8	8 12 16

\* Solderless

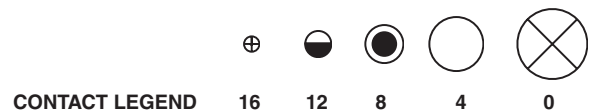

# Special contact arrangements

front face of pin insert or rear face of socket insert illustrated

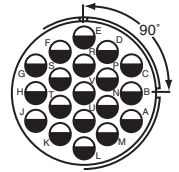
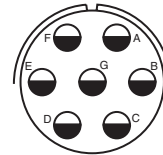
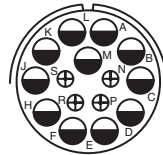
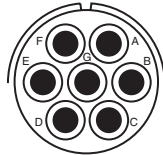
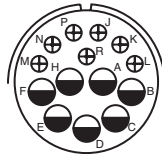

Insert Arrangement	24-59	24-60	24-65	24-66	24-67
Service Rating	A	A	A	D	Inst.
Number of Contacts	7 7	7*	11 4	7	19
Contact Size	12 16	8 for #10 or 12 wire	12 16	12	12

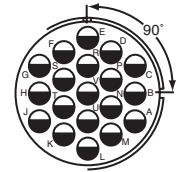
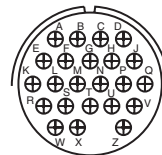
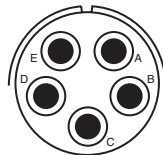
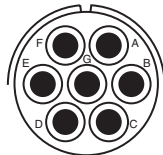
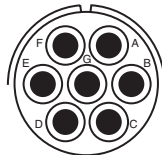

Insert Arrangement	24-71	24-75	24-79	24-80	24-84
Service Rating	A	A	A	Inst.	A
Number of Contacts	2* 5*	5 2	5	23	1 18
Contact Size	8 8 for #10 or 12 wire	8 8 for #16 wire	8	16	12 12 (Coax) RG-188/U or RG-174/U

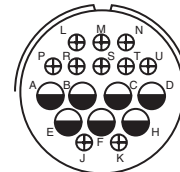
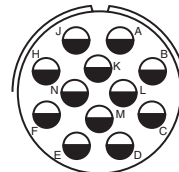
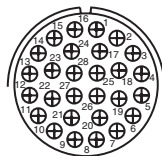

Insert Arrangement	24-96	24-AJ	28-51	28-59
Service Rating	Inst.	A	A	A
Number of Contacts	28	25	12	7 10
Contact Size	16	16	12	12 16

\* Solderless



# Special contact arrangements

front face of pin insert or rear face of socket insert illustrated

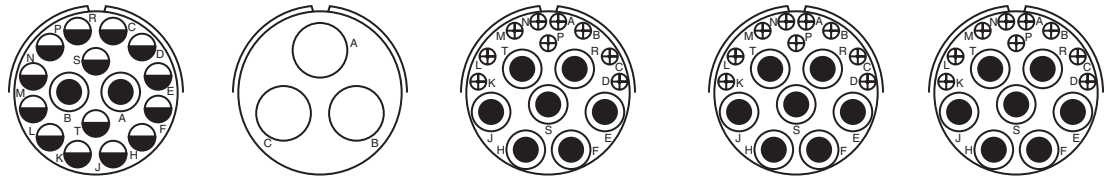

Insert Arrangement	28-66	28-72	28-74	28-75	28-79
Service Rating	A	—	A	A	A
Number of Contacts	2 14	3	9* 4* 3*	9* 7*	7 9
Contact Size	8 12	4 (Coax) RG-59A/U or RG-62A/U	16 8 8 for #10 wire (S, T, R)	16 8 for #10 wire	8 16

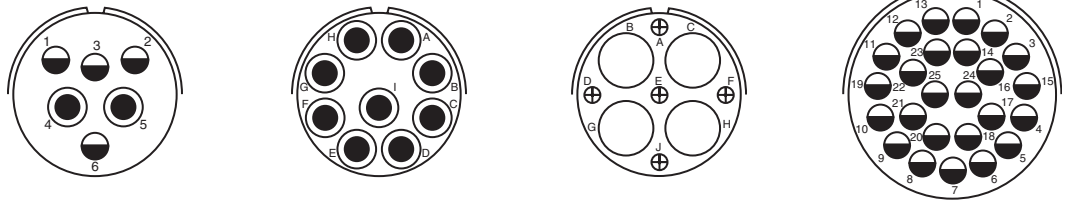

Insert Arrangement	28-82	28-84	28-AY	32-25
Service Rating	D	A	A	A
Number of Contacts	2 4	9	4 5	25
Contact Size	8 12	8	4 16	12

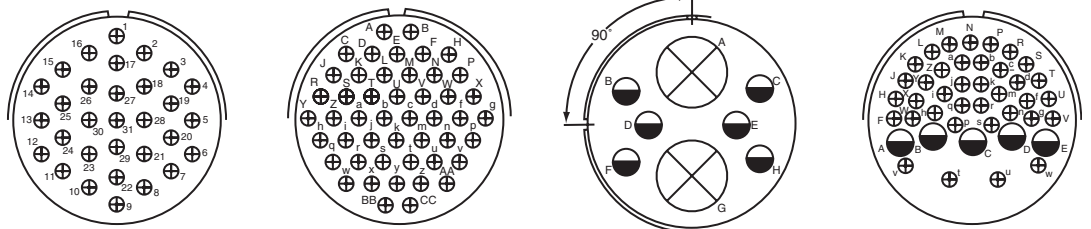

Insert Arrangement	32-31	32-48	32-52	32-53
Service Rating	A	Inst.	D	t, u = E; Bal. = Inst.
Number of Contacts	31	48	6 2	5 37
Contact Size	16	16	12 0	12 16

\* Solderless

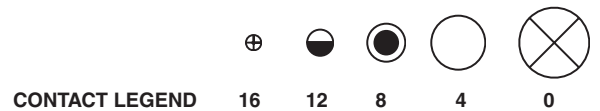

# Special contact arrangements

front face of pin insert or rear face of socket insert illustrated

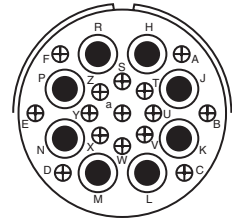
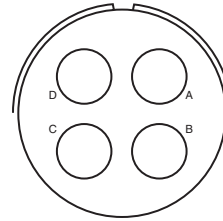
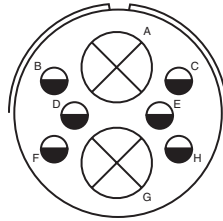
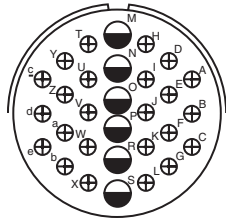

Insert Arrangement	32-56	32-57	32-58	32-60
Service Rating	A	**	-	A
Number of Contacts	24 6	6 2	4	15 8
Contact Size	16 12 for #10 wire	12 0 (Coax) RG-71/U	4 (Coax) RG-161/U or RG-179/U	16 8 (Coax) RG-124/U

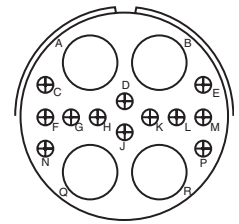
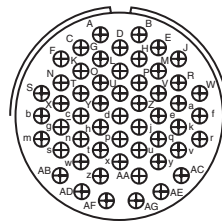
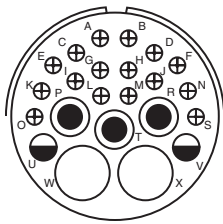

Insert Arrangement	32-62	32-64	32-68
Service Rating	**	Inst.	A
Number of Contacts	2 1 2 16 2	54	12 4
Contact Size	4 8 12 16 8 (Coax) RG-124/U	16	16 4 (Coax) RG-58C/U

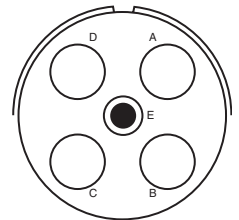
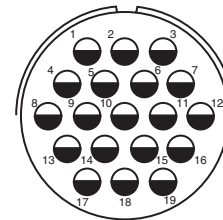
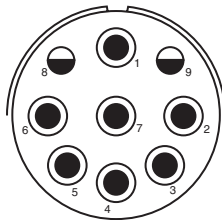
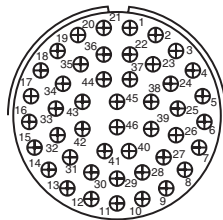

Insert Arrangement	32-73	32-75	32-76	32-79
Service Rating	A	8, 9 = D	A	D
Number of Contacts	46	2 7	19	4 1
Contact Size	16	12 8 (Coax) RG-180B/U	12	4 8

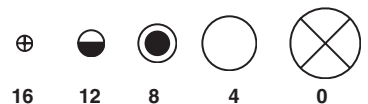

\*\* Consult Amphenol, Sidney, NY for service rating of power contacts.

# Special contact arrangements

front face of pin insert or rear face of socket insert illustrated

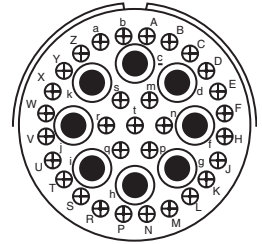
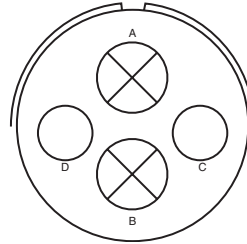
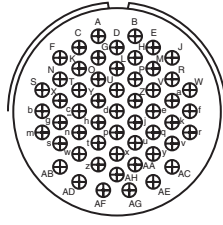
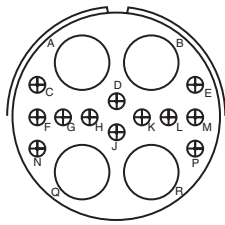

Insert Arrangement	32-82	32-AF	36-51	36-54
Service Rating	A	A	D	A
Number of Contacts	4 12	55	2 2	8 31
Contact Size	4 16	16	0 4	8 16

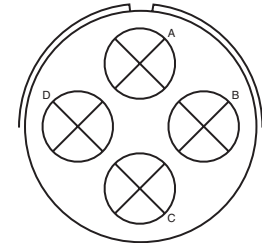
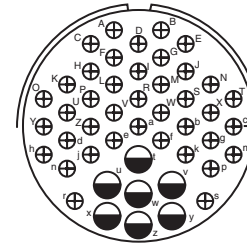
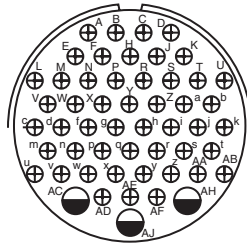
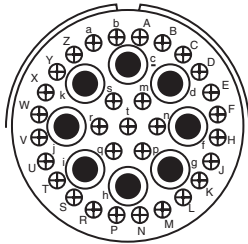

Insert Arrangement	36-55	36-59	36-60	36-64
Service Rating	A	A	**	-
Number of Contacts	31 8	50 3	40 7	4
Contact Size	16 8 for #6 wire	16 12 for #10 wire	16 12 for #10 wire	0 (Coax) RG-11/U, RG-12/U or RG-13/U

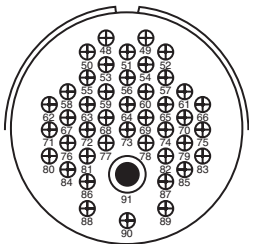
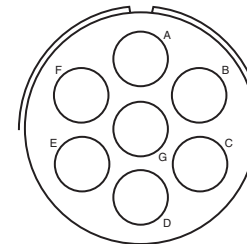
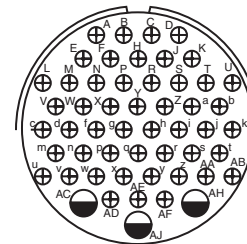
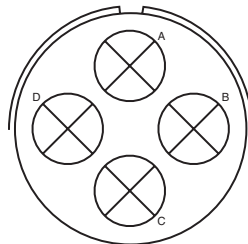

Insert Arrangement	36-65	36-71	36-73	36-74
Service Rating	-	A	-	A
Number of Contacts	4	3 50	7	43 1
Contact Size	0 (Coax) RG-59/U, RG-62/U or RG-71/U	12 16	4 (Coax) RG-62B/U	16 8 (Coax) RG-187/U

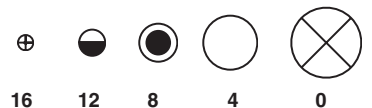

\*\* Consult Amphenol, Sidney, NY for service rating of power contacts.

# Special contact arrangements

front face of pin insert or rear face of socket insert illustrated

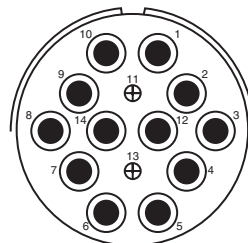
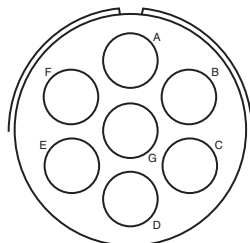
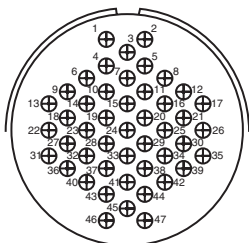
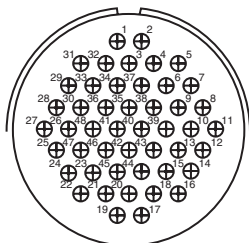

Insert Arrangement	36-75	36-76	36-77	36-78
Service Rating	A	A	D	A
Number of Contacts	48	47	7	2 12
Contact Size	16 for #14 wire	16	4	16 8

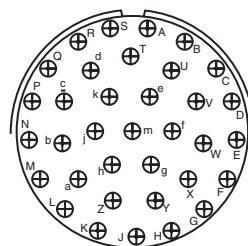
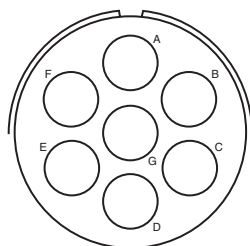
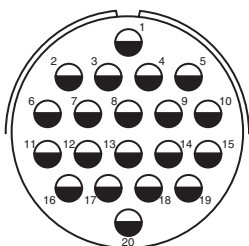
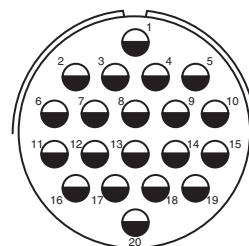

Insert Arrangement	36-79	36-80	36-83	36-85
Service Rating	A	A	-	M = D; Bal. = A
Number of Contacts	20	20	7	35
Contact Size	12	12 for #10 wire	4 (Coax) RG-58/U	16 for #12 wire

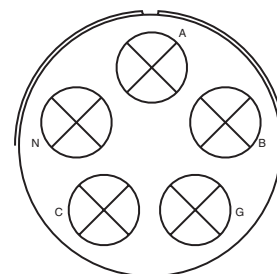
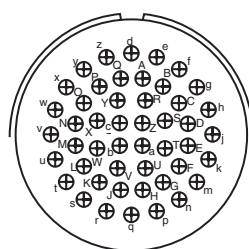
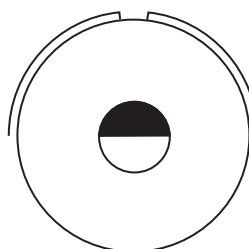

Insert Arrangement	36-97	36-AF	40-5
Service Rating	C	A	A
Number of Contacts	1	48	5
Contact Size	4/0	16	0

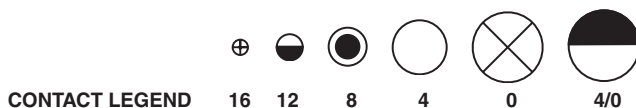



# Special contact arrangements

front face of pin insert or rear face of socket insert illustrated

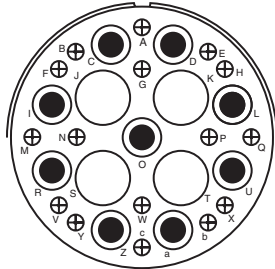

**Insert Arrangement** 40-10  
**Service Rating** A  
**Number of Contacts** 4 9 16  
**Contact Size** 4 8 16

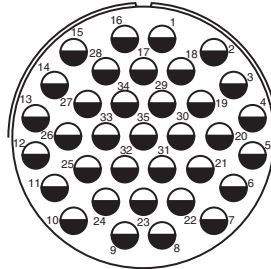

**Insert Arrangement** 40-35  
**Service Rating** D  
**Number of Contacts** 35  
**Contact Size** 12

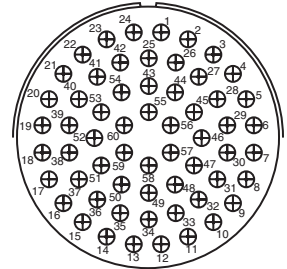

**Insert Arrangement** 40-57  
**Service Rating** E  
**Number of Contacts** 4  
**Contact Size** 0

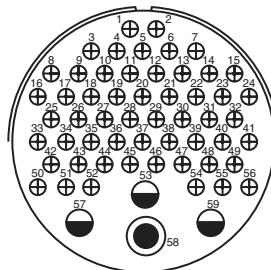

**Insert Arrangement** 40-61  
**Service Rating** A  
**Number of Contacts** 1 3 55  
**Contact Size** 8 12 16

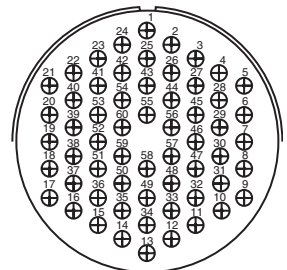

**Insert Arrangement** 40-63  
**Service Rating** A  
**Number of Contacts** 61  
**Contact Size** 16 for #14 wire

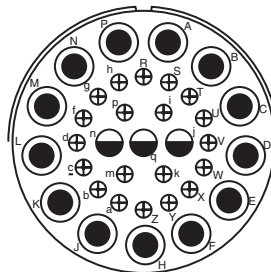

**Insert Arrangement** 40-64  
**Service Rating** -  
**Number of Contacts** 3 20 13  
**Contact Size** 12 16 8 (Coax) RG-124/U

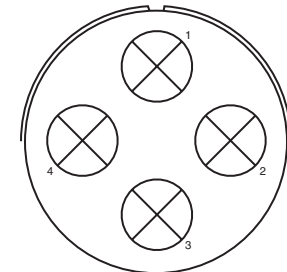

**Insert Arrangement** 40-66  
**Service Rating** -  
**Number of Contacts** 4  
**Contact Size** 0 (Coax) RG-63B/U

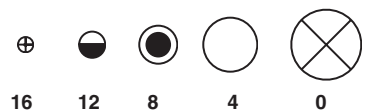

# Special contact arrangements

front face of pin insert or rear face of socket insert illustrated

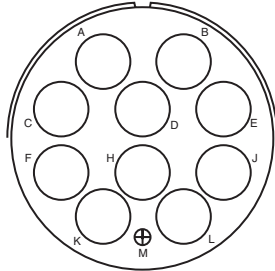

**Insert Arrangement** 40-67  
**Service Rating** A  
**Number of Contacts** 1 10  
**Contact Size** 16 4 (Coax) RG-59/U

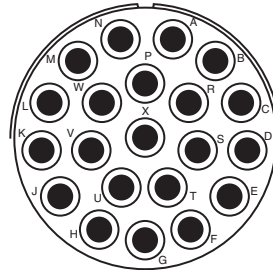

**Insert Arrangement** 40-68  
**Service Rating** A  
**Number of Contacts** 21  
**Contact Size** 8

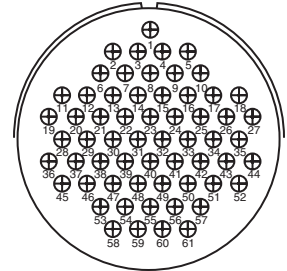

**Insert Arrangement** 40-70  
**Service Rating** A  
**Number of Contacts** 61  
**Contact Size** 16

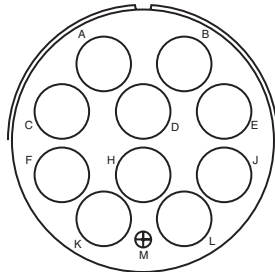

**Insert Arrangement** 40-72  
**Service Rating** A  
**Number of Contacts** 1 10  
**Contact Size** 16 4 (Coax) RG-9B/U

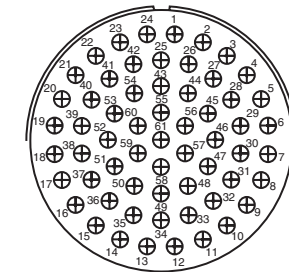

**Insert Arrangement** 40-73  
**Service Rating** A  
**Number of Contacts** 61  
**Contact Size** 16

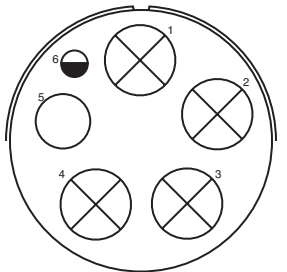

**Insert Arrangement** 40-74  
**Service Rating** A  
**Number of Contacts** 1 1 4  
**Contact Size** 12 4 (Coax) RG-62/U 0 (Coax) RG-9B/U or RG-214/U

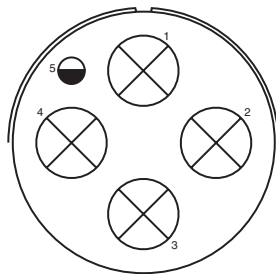

**Insert Arrangement** 40-75  
**Service Rating** E  
**Number of Contacts** 1 4  
**Contact Size** 12 0

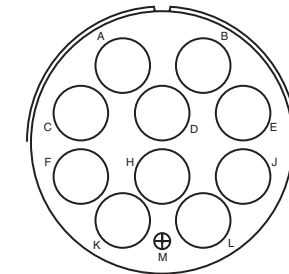

**Insert Arrangement** 40-80  
**Service Rating** A  
**Number of Contacts** 1 10  
**Contact Size** 16 4

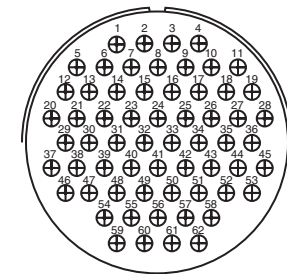

**Insert Arrangement** 40-81  
**Service Rating** A  
**Number of Contacts** 62  
**Contact Size** 16 for #14 wire

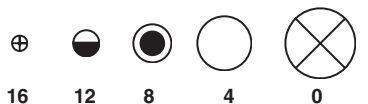

CONTACT LEGEND

# Special contact arrangements

front face of pin insert or rear face of socket insert illustrated

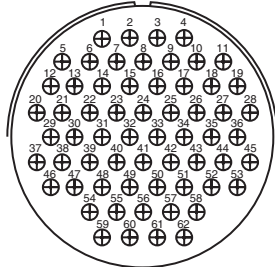

**40-82**

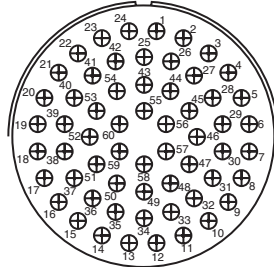

**40-85**

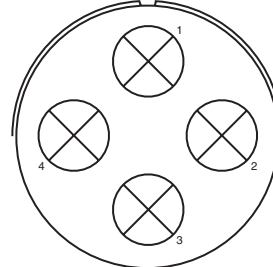

**40-86**

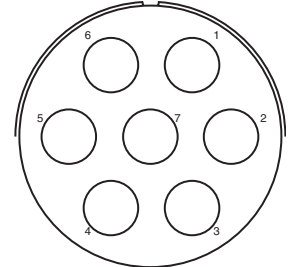

**40-87**

**Insert Arrangement**  
**Service Rating**  
**Number of Contacts**  
**Contact Size**

**A**  
**62**  
**16**

**A**  
**60**  
**16 for #14 wire**

**-**  
**4**  
**0(Coax) RG-115A/U**

**D**  
**7**  
**4**

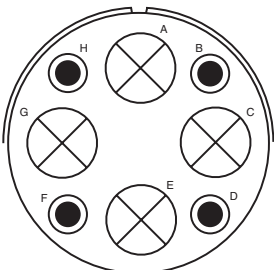

**40-AD**

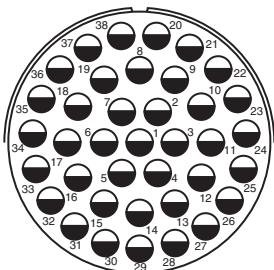

**40-AG**

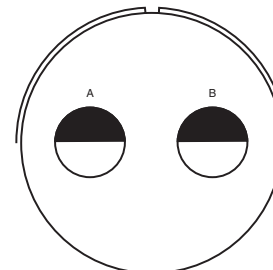

**40-AP**

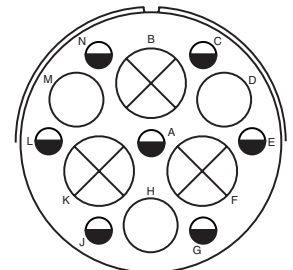

**40-AR**

**Insert Arrangement**  
**Service Rating**  
**Number of Contacts**  
**Contact Size**

**A**  
**4 4**  
**8 0**

**A**  
**38**  
**12**

**E**  
**2**  
**4/0**

**Inst.**  
**7 3 3**  
**12 4 0**

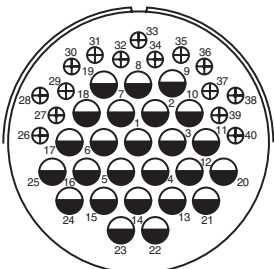

**40-AS**

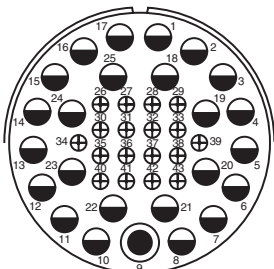

**40-AT**

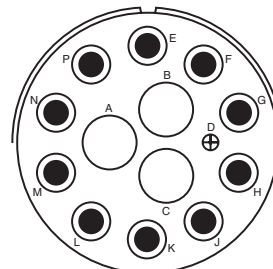

**40-AU**

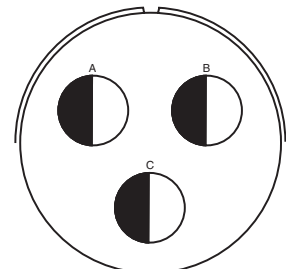

**40-AV**

**Insert Arrangement**  
**Service Rating**  
**Number of Contacts**  
**Contact Size**

**A**  
**15 25**  
**16 12**

**A**  
**24 18 1**  
**12 16 8**

**A**  
**3 10 1**  
**4 8 16**

**D**  
**3**  
**2/0**

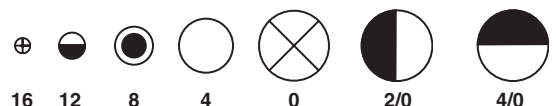

**CONTACT LEGEND**

**16 12 8 4 0 2/0 4/0**

# Special contact arrangements

front face of pin insert or rear face of socket insert illustrated

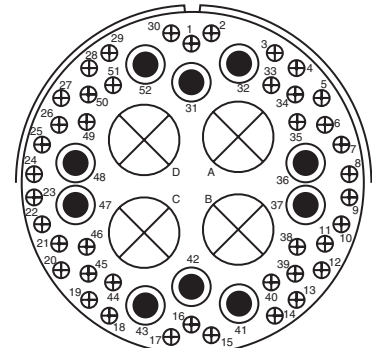
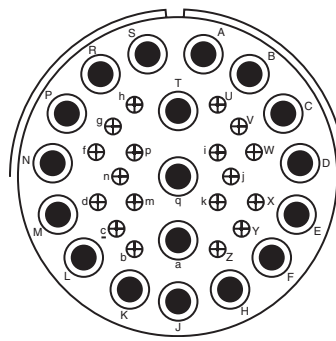
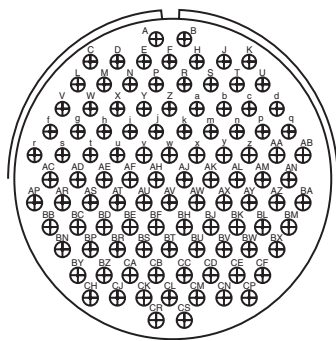

Insert Arrangement	44-52	44-53	48-51
Service Rating	A	A	A
Number of Contacts	104	18 18	42 10 4
Contact Size	16	16 8 (Coax) RG-124/U	16 8 0 (Coax) RG-41/U

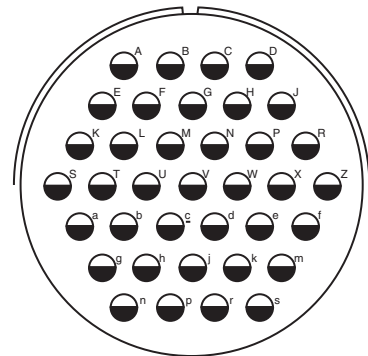
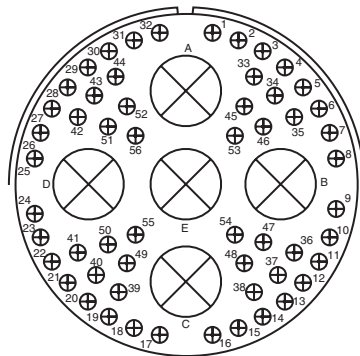

Insert Arrangement	48-52	48-53
Service Rating	A	D
Number of Contacts	56 5	37
Contact Size	16 0 (Coax) RG-41/U	12



# Special contact arrangements

front face of pin insert or rear face of socket insert illustrated

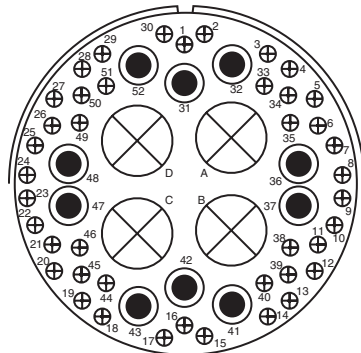

**48-54**

**Insert Arrangement**  
**Service Rating**  
**Number of Contacts**  
**Contact Size**

**A**  
**42 10 4**  
**16 8 0 (Coax) RG-59/U**

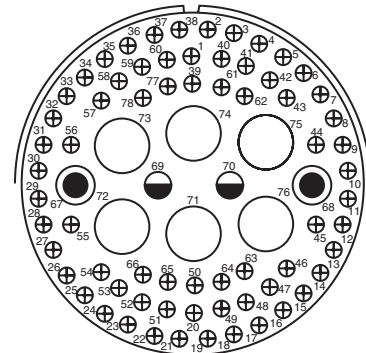

**48-55**

**A**  
**68 2 2 6**  
**16 12 8 4**

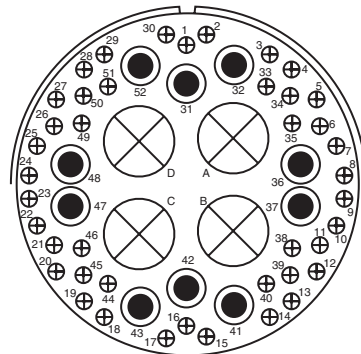

**48-57**

**Insert Arrangement**  
**Service Rating**  
**Number of Contacts**  
**Contact Size**

**A**  
**42 10 4**  
**16 8 0**

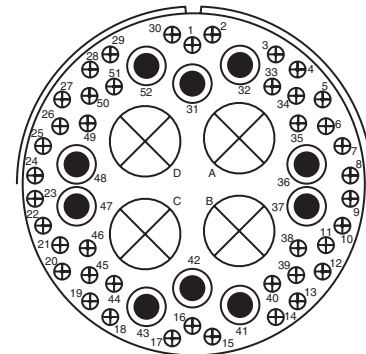

**48-60**

**A**  
**42 10 4**  
**16 8 0 (Coax) RG-214/U**



**CONTACT LEGEND**    16    12    8    4    0

# QWL – accessories cabling information

The Amphenol® QWL series of electrical connectors has been designed with the problems of multi-conductor cable users in mind. Two of these problems, namely water proofing and strain relief, are solved by the radial inward compression of an internal neoprene gland in the various cable accessories shown on the following pages. For additional strain relief beyond that provided by the gland, both cable grips and bar clamps are available. Since the glands close down from .094” to .145” (depending on shell size), the optimum condition for cable users is to select a gland with an I.D. only slightly larger than the maximum O.D. of the cable. The inside diameter of the accessory housing determines the maximum diameter of the cable as shown in the tabulation below. Smaller sizes than those shown in each shell size can be accommodated by smaller compression glands.

Different cable manufacturers use different constructions and cable lays in manufacturing multi-conductor cable. The specific cabling manufacturing specification should be known by the customer in detail in order to properly figure each QWL application. This knowledge can save many individual wire crossovers in any given run of cable. Crossovers add materially to the cable diameter without a cable accessory. In those cases where diameter buildup is impossible to avoid, special cable accessories with longer barrels are available.

How to order information is covered in detail on pages 4 and 5. In selecting the base number below, care should be used, as some of the cable accessories are provided with protection cap attachment rings, while others are provided with the Kellems strain relief grip as shown. If a type or cable accommodation size is not found herein that fulfills your application, please contact Amphenol, Sidney, NY.

All dimensions for reference only.

Shell Size	QWL Connector Accessory Thd.	Approx. Work Length (Internal)		Minimum Housing Inner Diameter	Maximum Cable Outer Diameter
		Short	Long		
10	.500-28	.250		.359	.359
12	.625-24	.375		.484	.484
14	.750-20	.401		.609	.609
16	.875-20	.500		.734	.734
18	1.000-20	1.120		.859	.859
20	1.125-18	1.370		.984	.984
22	1.250-18	1.370		1.109	1.109
24	1.375-18	1.370		1.234	1.234
28	1.625-18	1.370	5.000	1.427	1.427
32	1.875-16	1.370	6.000	1.708	1.708
36	2.062-16	1.370	5.000	1.895	1.895
40	2.312-16	1.370	6.000	2.130	2.130
44	2.625-16			2.375	2.375
48	2.875-16	2.218	6.000	2.630	2.630

# QWL – cable accessories

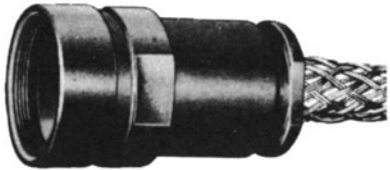

**10-101332**  
Short barrel with grip

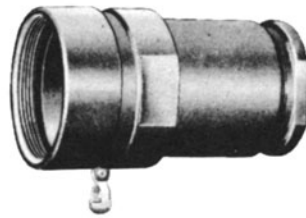

**10-101335**  
Short barrel with attachment ring

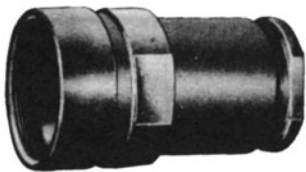

**10-101333**  
Short barrel without grip

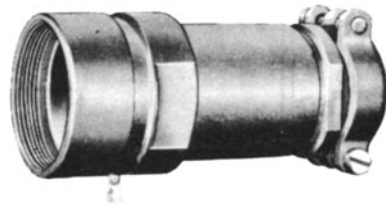

**10-130380**  
Short barrel length with attachment ring & strain relief bars

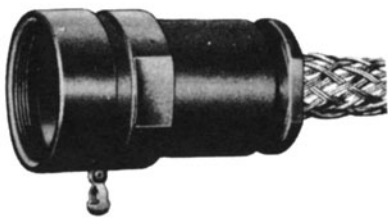

**10-101334**  
Short barrel with grip & attachment ring

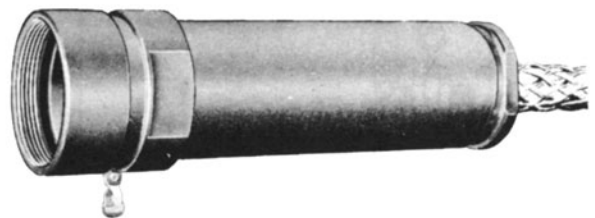

**10-113637**  
Long barrel with attachment ring and grip

# QWL – accessories

## 10-130380

### cable sealing adapter (with clamp bars)

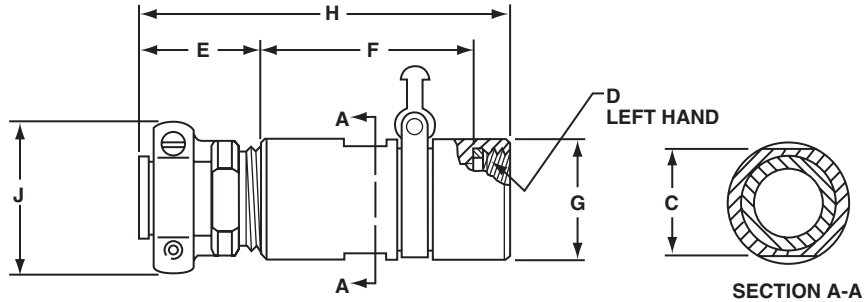
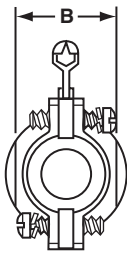

Type I Straight

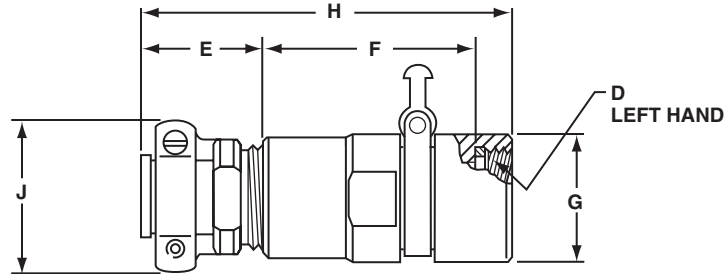
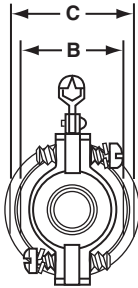

Type II Step Down

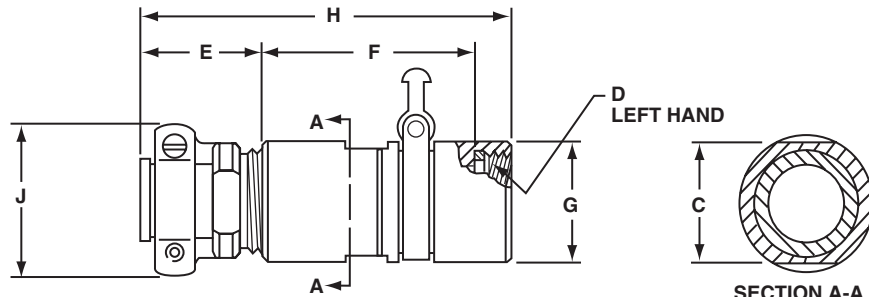
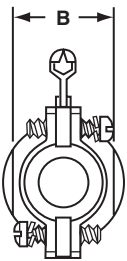

Type III Step Up



# QWL – accessories

## 10-130380

### cable sealing adapter (with clamp bars)

All dimensions are for reference only.

Part Number*	Used With Shell Size	Cable Range		B +.000 -.010	C +.010 -.000	D Thread Class 2B-LH	E Free Max	F +.010 -.020	G Dia. +.010 -.020	H Max.	J Max.	Type
		Max. Dia.	Min. Dia.									
10-130380-141	14S	.460	.366	.750	.812	.750-20UNEF	1.125	1.782	.938	3.229	1.062	I
10-130380-142	14S	.438	.344	.875	.938	.750-20UNEF	1.125	2.126	.938	3.573	1.125	III
10-130380-143	14S	.375	.306	.875	.938	.750-20UNEF	1.125	2.126	.938	3.573	1.125	III
10-130380-161	16S	.530	.436	1.000	1.062	.875-20UNEF	1.250	2.282	1.062	3.854	1.375	III
10-130380-162	16S	.605	.511	1.000	1.062	.875-20UNEF	1.250	2.282	1.062	3.854	1.375	III
10-130380-171	16	.500	.406	.875	.938	.875-20UNEF	1.125	2.215	1.062	3.834	1.125	I
10-130380-181	18	.828	.715	1.188	1.250	1.000-20UNEF	1.250	3.032	1.188	4.776	1.688	III
10-130380-182	18	.699	.605	1.062	1.125	1.000-20UNEF	1.250	2.933	1.188	4.677	1.562	III
10-130380-183	18	.500	.406	.875	1.094	1.000-20UNEF	1.125	2.485	1.188	4.104	1.125	II
10-130380-184	18	.562	.449	1.188	1.250	1.000-20UNEF	1.250	3.032	1.188	4.776	1.688	III
10-130380-185	18	.750	.637	1.312	1.000	1.000-20UNEF	1.250	3.063	1.188	4.607	1.812	III
10-130380-186	18	.530	.436	1.000	1.062	1.000-20UNEF	1.250	2.621	1.188	4.365	1.375	I
10-130380-201	20	.625	.531	1.062	1.125	1.125-18UNEF	1.250	2.933	1.312	4.677	1.562	I
10-130380-202	20	.605	.511	1.000	1.125	1.125-18UNEF	1.250	2.631	1.312	4.365	1.375	II
10-130380-203	20	.628	.715	1.188	1.125	1.125-18UNEF	1.250	2.996	1.312	4.740	1.688	III
10-130380-204	20	.720	.626	1.062	1.125	1.125-18UNEF	1.250	2.933	1.312	4.677	1.562	I
10-130380-205	20	.900	.787	1.312	1.250	1.125-18UNEF	1.250	3.062	1.312	4.807	1.812	III
10-130380-206	20	.625	.531	1.062	1.125	1.125-18UNEF	1.250	2.933	1.312	4.677	1.562	I
10-130380-207	20	.750	.637	1.312	1.250	1.125-18UNEF	1.250	3.063	1.312	4.807	1.812	III
10-130380-221	22	.790	.696	1.062	1.250	1.250-18UNEF	1.250	2.933	1.438	4.677	1.562	II
10-130380-222	22	.720	.626	1.062	1.250	1.250-18UNEF	1.250	2.933	1.438	4.677	1.562	II
10-130380-223	22	1.130	1.005	1.780	1.375	1.250-18UNEF	1.500	3.266	1.438	5.250	2.469	III
10-130380-224	22	.680	.567	1.312	1.375	1.250-18UNEF	1.250	3.059	1.438	4.803	1.812	III
10-130380-242	24	.900	.787	1.312	1.375	1.375-18UNEF	1.250	3.059	1.562	4.803	1.812	I
10-130380-243	24	1.180	1.055	1.780	1.812	1.375-18UNEF	1.500	3.204	1.562	5.198	2.469	III
10-130380-244	24	.680	.567	1.312	1.375	1.375-18UNEF	1.250	3.059	1.562	4.803	1.812	I
10-130380-245	24	.630	.517	1.312	1.375	1.375-18UNEF	1.250	3.059	1.562	4.803	1.812	I
10-130380-246	24	1.000	.875	1.546	1.625	1.375-18UNEF	1.500	3.121	1.562	5.115	2.125	III
10-130380-247	24	.805	.692	1.312	1.375	1.375-18UNEF	1.250	3.059	1.562	4.803	1.812	I
10-130380-281	28	1.310	1.185	1.780	1.875	1.625-18UNEF	1.500	3.184	1.812	5.178	2.469	III
10-130380-282	28	.970	.857	1.312	1.625	1.625-18UNEF	1.250	3.059	1.812	4.803	1.812	II
10-130380-283	28	.880	.755	1.546	1.625	1.625-18UNEF	1.500	3.121	1.812	5.115	2.125	I
10-130380-284	28	1.427	1.320	2.000	1.875	1.625-18UNEF	1.500	3.184	1.812	5.178	2.625	III
10-130380-321	32	.970	.875	1.312	1.875	1.875-16UN	1.250	3.059	2.062	4.803	1.812	II
10-130380-322	32	1.230	1.105	1.780	1.875	1.875-16UN	1.500	3.184	2.062	5.178	2.469	I
10-130380-323	32	1.328	1.240	1.780	1.875	1.875-16UN	1.500	3.184	2.062	5.178	2.469	I
10-130380-324	32	.750	.637	1.312	1.875	1.875-16UN	1.250	3.059	2.062	4.803	1.812	II
10-130380-325	32	1.055	.958	1.546	1.875	1.875-16UN	1.500	3.121	2.062	5.115	2.125	II
10-130380-326	32	1.375	1.250	2.000	2.062	1.875-16UN	1.500	3.246	2.062	5.240	2.625	III
10-130380-361	36	1.310	1.185	1.780	2.062	2.0625-16UN	1.500	3.184	2.312	5.178	2.469	II
10-130380-362	36	1.900	1.775	2.438	2.312	2.0625-16UN	1.625	3.500	2.312	5.619	3.171	III
10-130380-363	36	1.530	1.406	2.000	2.062	2.0625-16UN	1.500	3.246	2.312	5.240	2.625	I
10-130380-364	36	1.445	1.320	2.000	2.062	2.0625-16UN	1.500	3.246	2.312	5.240	2.625	I
10-130380-365	36	.805	.692	1.312	2.062	2.0625-16UN	1.250	3.059	2.312	4.803	1.812	II
10-130380-366	36	.603	.511	1.000	2.000	2.0625-16UN	1.250	2.875	2.312	4.619	1.375	II
10-130380-367	36	1.000	.875	1.546	2.062	2.0625-16UN	1.500	3.121	2.312	5.115	2.125	II
10-130380-401	40	1.730	1.605	2.438	2.500	2.3125-16UN	1.625	3.469	2.562	5.588	3.171	III
10-130380-402	40	1.310	1.185	1.780	2.312	2.3125-16UN	1.500	3.184	2.562	5.178	2.469	II
10-130380-403	40	1.180	1.055	1.780	2.312	2.3125-16UN	1.500	3.184	2.562	5.178	2.469	II
10-130380-404	40	1.109	.984	1.546	2.312	2.3125-16UN	1.500	3.121	2.562	5.115	2.125	II
10-130380-441	44	1.900	1.775	2.438	2.750	2.625-16UN	1.625	4.281	2.875	6.588	3.171	II

\*For complete order number see pages 4 and 5.

# QWL – accessories

## 10-10133X

### cable sealing adapter

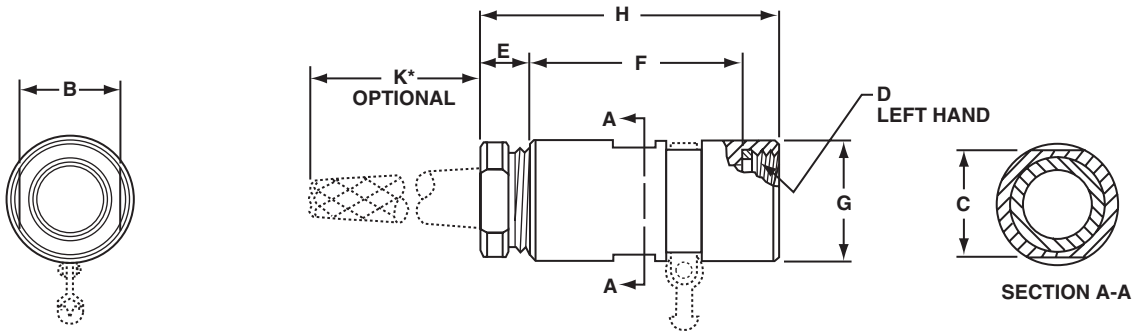

Type I Straight

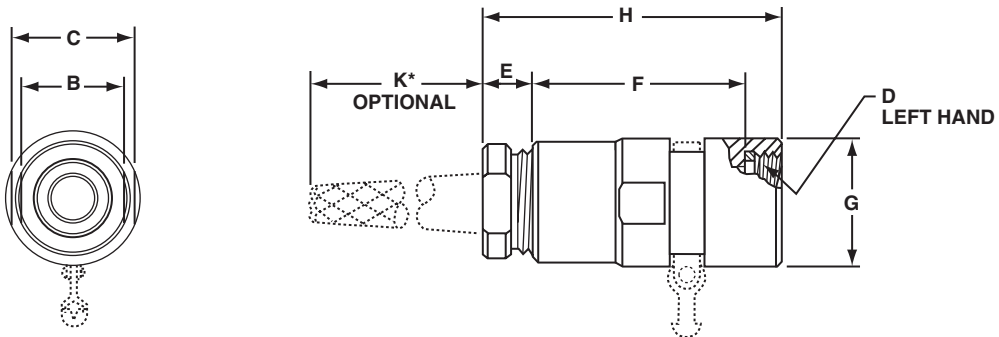

Type II Step Down

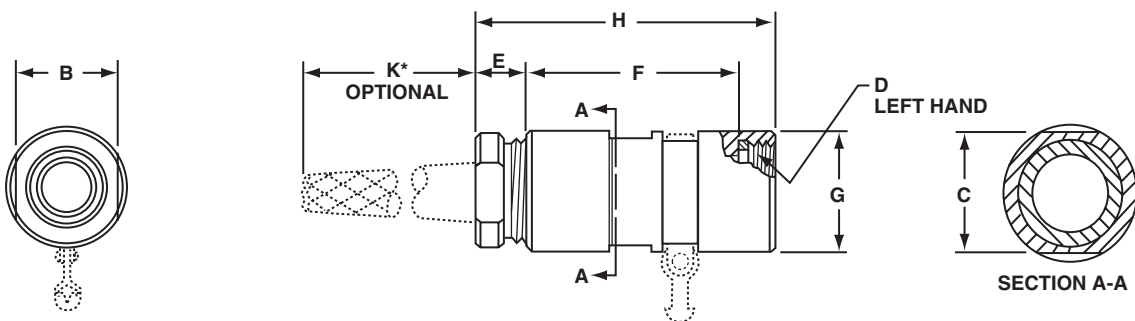

Type III Step Up

\*Wire grip dimensions (K) apply to 10-101332 and 10-101334 assemblies only.

# QWL – accessories

## 10-10133X

### cable sealing adapter

All dimensions are for reference only.

Part Number*	Used With Shell Size	Cable Range		B +.000 -.010	C +.010 -.000	D Thread Class 2B-LH	E Free Max.	F +.010 -.020	G Dia. +.010 -.020	H ±.045	K Free Approx.	Type
		Max. Dia.	Min. Dia.									
10-10133X-121	12S	.281	.219	.750	.812	.6250-24NEF	.500	1.938	.812	2.750	2.844	III
10-10133X-122	12S	.500	.406	1.062	1.000	.6250-24NEF	.562	2.875	.812	3.750	4.688	III
10-10133X-123	12S	.405	.316	1.000	.812	.6250-24NEF	.562	2.548	.812	3.422	3.688	III
10-10133X-141	14S	.337	.281	.750	.812	.7500-20UNEF	.500	1.782	.938	2.594	3.344	I
10-10133X-142	14S	.222	.160	.625	.812	.7500-20UNEF	.562	1.782	.938	2.532	2.406	II
10-10133X-143	14S	.281	.219	.750	.812	.7500-20UNEF	.500	1.782	.938	2.594	2.844	I
10-10133X-144	14S	.530	.441	1.000	.812	.7500-20UNEF	.562	2.719	.938	3.594	4.688	III
10-10133X-145	14S	.463	.406	.875	.938	.7500-20UNEF	.500	2.126	.938	2.938	4.344	III
10-10133X-146	14S	.405	.316	1.000	.812	.7500-20UNEF	.562	2.719	.938	3.594	3.688	III
10-10133X-151	14	.405	.316	1.000	.812	.7500-20UNEF	.562	2.719	.938	3.765	3.688	III
10-10133X-161	16S	.463	.406	.875	.938	.8750-20UNEF	.500	1.844	1.062	2.656	4.344	I
10-10133X-162	16S	.589	.511	1.000	1.062	.8750-20UNEF	.562	2.282	1.062	3.156	5.188	III
10-10133X-163	16S	.625	.580	1.062	1.125	.8750-20UNEF	.562	2.933	1.062	3.807	6.188	III
10-10133X-164	16S	.405	.316	1.000	1.062	.8750-20UNEF	.562	2.282	1.062	3.156	3.688	III
10-10133X-165	16S	.530	.441	1.000	1.062	.8750-20UNEF	.562	2.282	1.062	3.156	4.688	III
10-10133X-166	16S	.699	.605	1.062	1.125	.8750-20UNEF	.562	2.933	1.062	3.807	6.188	III
10-10133X-167	16S	.281	.219	.750	.938	.8750-20UNEF	.500	1.844	1.062	2.656	2.844	II
10-10133X-171	16	.589	.511	1.000	1.062	.8750-20UNEF	.562	2.621	1.062	3.667	5.188	III
10-10133X-172	16	.438	.400	.875	.938	.8750-20UNEF	.500	2.215	1.062	3.199	4.344	I
10-10133X-173	16	.625	.580	1.062	1.125	.8750-20UNEF	.562	2.933	1.062	3.979	6.188	III
10-10133X-174	16	.530	.441	1.000	1.062	.8750-20UNEF	.562	2.621	1.062	3.667	4.688	III
10-10133X-175	16	.405	.316	1.000	1.062	.8750-20UNEF	.562	2.621	1.062	3.667	3.688	III
10-10133X-181	18	.589	.511	1.000	1.062	1.0000-20UNEF	.562	2.621	1.188	3.667	5.188	I
10-10133X-182	18	.625	.580	1.062	1.125	1.0000-20UNEF	.562	2.933	1.188	3.979	6.188	III
10-10133X-183	18	.530	.441	1.000	1.062	1.0000-20UNEF	.562	2.621	1.188	3.667	4.688	I
10-10133X-184	18	.699	.605	1.062	1.125	1.0000-20UNEF	.562	2.933	1.188	3.979	6.188	III
10-10133X-185	18	.405	.316	1.000	1.062	1.0000-20UNEF	.562	2.621	1.188	3.667	3.688	I
10-10133X-186	18	.455	.361	1.062	1.125	1.0000-20UNEF	.562	2.933	1.188	3.979	4.188	III
10-10133X-187	18	.750	.637	1.250	1.000	1.0000-20UNEF	.562	3.063	1.188	4.109	6.688	III
10-10133X-188	18	.172	.078	.750	.938	1.0000-20UNEF	.500	2.407	1.188	3.391	2.844	II
10-10133X-190	18	.805	.692	1.250	1.000	1.0000-20UNEF	.562	3.063	1.188	4.109	6.688	III
10-10133X-201	20	.625	.580	1.062	1.125	1.1250-18NEF	.562	2.933	1.312	3.979	6.188	I
10-10133X-202	20	.699	.605	1.062	1.125	1.1250-18NEF	.562	2.933	1.312	3.979	6.188	I
10-10133X-203	20	.500	.406	1.062	1.125	1.1250-18NEF	.562	2.933	1.312	3.979	4.688	I
10-10133X-204	20	.337	.281	.750	1.125	1.1250-18NEF	.500	2.438	1.312	3.422	3.344	II
10-10133X-205	20	.828	.715	1.125	1.250	1.1250-18NEF	.547	2.996	1.312	4.042	6.688	III
10-10133X-206	20	.375	.312	.875	1.125	1.1250-18NEF	.500	2.469	1.312	3.453	3.844	II
10-10133X-207	20	.281	.219	.750	1.125	1.1250-18NEF	.500	2.438	1.312	3.422	2.844	II
10-10133X-208	20	.455	.361	1.062	1.125	1.1250-18NEF	.562	2.933	1.312	3.979	4.188	I
10-10133X-209	20	.589	.511	1.000	1.125	1.1250-18NEF	.562	2.621	1.312	3.667	5.188	II
10-10133X-210	20	.530	.441	1.000	1.125	1.1250-18NEF	.562	2.621	1.312	3.667	4.688	II
10-10133X-211	20	.900	.791	1.250	1.250	1.1250-18NEF	.562	3.063	1.312	4.109	7.188	III

\*For complete order number see pages 4 and 5.

# QWL – accessories

## 10-10133X

### cable sealing adapter

All dimensions are for reference only.

Part Number*	Used With Shell Size	Cable Range		B +.000 -.010	C +.000 -.010	D Thread Class 2B-LH	E Free ±.010	F +.010 -.020	G Dia. +.010 -.020	H ±.045	K Free Approx.	Type
		Max. Dia.	Min. Dia.									
10-10133X-221	22	.699	.605	1.062	1.250	1.2500-18NEF	.562	2.933	1.438	3.979	6.188	II
10-10133X-222	22	.750	.637	1.250	1.375	1.2500-18NEF	.562	3.059	1.438	4.105	6.688	III
10-10133X-223	22	.445	.367	1.062	1.250	1.2500-18NEF	.562	2.933	1.438	3.979	4.188	II
10-10133X-224	22	1.000	.875	1.500	1.375	1.2500-18NEF	.562	3.121	1.438	4.167	7.188	III
10-10133X-225	22	.828	.715	1.125	1.250	1.2500-18NEF	.594	2.996	1.438	4.072	6.688	I
10-10133X-226	22	.900	.791	1.250	1.375	1.2500-18NEF	.562	3.059	1.438	4.105	7.188	III
10-10133X-227	22	.562	.453	1.125	1.250	1.2500-18NEF	.594	2.996	1.438	4.074	5.188	I
10-10133X-228	22	1.101	.984	1.500	1.375	1.2500-18NEF	.562	3.121	1.438	4.167	7.688	III
10-10133X-229	22	.589	.511	1.000	1.250	1.2500-18NEF	.562	2.750	1.438	3.796	5.188	II
10-10133X-231	22	1.055	.958	1.500	1.375	1.2500-18NEF	.562	3.121	1.438	4.167	7.688	III
10-10133X-241	24	1.000	.875	1.500	1.625	1.3750-18NEF	.562	3.121	1.562	4.167	7.188	III
10-10133X-242	24	.562	.453	1.125	1.406	1.3750-18NEF	.562	2.996	1.562	4.042	5.188	II
10-10133X-243	24	.750	.637	1.250	1.375	1.3750-18NEF	.562	3.059	1.562	4.105	6.688	I
10-10133X-244	24	.900	.791	1.250	1.375	1.3750-18NEF	.562	3.059	1.562	4.105	7.188	I
10-10133X-245	24	1.101	.984	1.500	1.625	1.3750-18NEF	.562	3.121	1.562	4.167	7.688	III
10-10133X-246	24	.405	.316	1.000	1.375	1.3750-18NEF	.562	2.750	1.562	3.796	3.688	II
10-10133X-247	24	.828	.715	1.125	1.406	1.3750-18NEF	.562	2.996	1.562	4.042	6.688	II
10-10133X-248	24	.805	.692	1.250	1.375	1.3750-18NEF	.562	3.059	1.562	4.105	6.688	I
10-10133X-249	24	1.130	1.005	1.750	1.812	1.3750-18NEF	.562	3.204	1.562	4.250	7.188	III
10-10133X-281	28	1.055	.958	1.500	1.625	1.6250-18NEF	.562	3.121	1.812	4.167	7.688	I
10-10133X-282	28	.900	.791	1.250	1.625	1.6250-18NEF	.562	3.059	1.812	4.105	7.188	II
10-10133X-283	28	1.000	.875	1.500	1.625	1.6250-18NEF	.562	3.121	1.812	4.167	7.188	I
10-10133X-284	28	.630	.535	1.250	1.625	1.6250-18NEF	.562	3.059	1.812	4.105	5.688	II
10-10133X-285	28	.750	.637	1.250	1.625	1.6250-18NEF	.562	3.059	1.812	4.105	6.688	II
10-10133X-286	28	1.180	1.099	1.750	1.875	1.6250-18NEF	.562	3.184	1.812	4.230	8.188	III
10-10133X-287	28	1.101	.984	1.500	1.625	1.6250-18NEF	.562	3.121	1.812	4.167	7.688	I
10-10133X-288	28	1.310	1.200	1.750	1.875	1.6250-18NEF	.562	3.184	1.812	4.230	8.688	III
10-10133X-289	28	1.230	1.105	1.750	1.875	1.6250-18NEF	.562	3.184	1.812	4.230	8.188	III
10-10133X-290	28	.880	.755	1.500	1.625	1.6250-18NEF	.562	3.121	1.812	4.167	6.688	I
10-10133X-291	28	.957	.857	1.250	1.625	1.6250-18NEF	.547	3.059	1.812	4.090	7.188	II
10-10133X-292	28	.828	.715	1.125	1.625	1.6250-18NEF	.562	2.954	1.812	4.000	6.688	II
10-10133X-293	28	1.375	1.250	2.000	1.875	1.6250-18NEF	.562	3.184	1.812	4.230	9.688	III
10-10133X-294	28	1.445	1.320	2.000	1.875	1.6250-18NEF	.562	3.184	1.812	4.230	9.688	III
10-10133X-295	28	.805	.692	1.250	1.625	1.6250-18NEF	.562	3.059	1.812	4.105	6.688	II
10-10133X-321	32	.880	.755	1.500	1.875	1.8750-16N	.562	3.121	2.062	4.167	6.688	II
10-10133X-322	32	1.101	.984	1.500	1.875	1.8750-16N	.562	3.121	2.062	4.167	7.688	II
10-10133X-323	32	.750	.637	1.250	1.875	1.8750-16N	.562	3.059	2.062	4.105	6.688	II
10-10133X-324	32	1.445	1.320	2.000	2.062	1.8750-16N	.672	3.246	2.062	4.292	9.688	III
10-10133X-325	32	1.180	1.099	1.750	1.875	1.8750-16N	.562	3.184	2.062	4.230	8.188	I
10-10133X-326	32	.375	.312	.875	1.875	1.8750-16N	.500	2.766	2.062	3.750	3.844	II
10-10133X-327	32	.957	.857	1.250	1.875	1.8750-16N	.562	3.059	2.062	4.105	7.188	II
10-10133X-328	32	1.230	1.105	1.750	1.875	1.8750-16N	.562	3.184	2.062	4.230	8.188	I
10-10133X-329	32	1.530	1.406	2.000	2.062	1.8750-16N	.562	3.246	2.062	4.292	10.688	III
10-10133X-330	32	1.000	.875	1.500	1.875	1.8750-16N	.562	3.121	2.062	4.167	7.188	II
10-10133X-331	32	1.375	1.250	2.000	2.062	1.8750-16N	.562	3.246	2.062	4.292	9.688	III
10-10133X-332	32	1.310	1.200	1.750	1.875	1.8750-16N	.562	3.184	2.062	4.230	8.688	I
10-10133X-333	32	.580 x .825	(Oval)	1.500	1.875	1.8750-16N	.562	3.121	2.062	4.167	6.688	II
10-10133X-334	32	.500 x .705	(Oval)	1.500	1.875	1.8750-16N	.562	3.121	2.062	4.167	6.688	II

\*For complete order number see pages 4 and 5.

# QWL – accessories

## 10-10133X

### cable sealing adapter

All dimensions are for reference only.

Part Number*	Used With Shell Size	Cable Range		B +.000 -.010	C +.000 -.010	D Thread Class 2B-LH	E Free ±.035	F +.010 -.020	G Dia. +.010 -.020	H ±.045	K Free Approx.	Type
		Max. Dia.	Min. Dia.									
10-10133X-335	32	.530	.441	1.000	1.625	1.8750-16N	.562	2.875	2.062	3.921	4.688	II
10-10133X-336	32	.680	.567	1.250	1.875	1.8750-16N	.562	3.059	2.062	4.105	6.688	II
10-10133X-337	32	.463	.406	.875	1.875	1.8750-16N	.500	2.766	2.062	3.750	4.344	II
10-10133X-361	36	1.055	.958	1.500	2.062	2.0625-16N	.562	3.121	2.312	4.167	7.688	II
10-10133X-362	36	1.445	1.320	2.000	2.062	2.0625-16N	.562	3.246	2.312	4.292	9.688	I
10-10133X-363	36	1.530	1.406	2.000	2.062	2.0625-16N	.562	3.246	2.312	4.292	10.688	I
10-10133X-364	36	1.230	1.105	1.750	2.062	2.0625-16N	.562	3.184	2.312	4.230	8.188	II
10-10133X-365	36	.750	.637	1.250	2.062	2.0625-16N	.562	3.059	2.312	4.105	6.688	II
10-10133X-366	36	.880	.755	1.500	2.062	2.0625-16N	.562	3.121	2.312	4.167	6.688	II
10-10133X-367	36	1.656	1.531	2.250	2.312	2.0625-16N	.562	3.308	2.312	4.354	12.688	III
10-10133X-368	36	1.101	.984	1.500	2.062	2.0625-16N	.562	3.121	2.312	4.167	7.688	II
10-10133X-369	36	.957	.857	1.250	2.062	2.0625-16N	.672	3.059	2.312	4.090	7.188	II
10-10133X-370	36	1.900	1.775	2.438	2.312	2.0625-16N	.500	3.500	2.312	4.656	13.688	III
10-10133X-371	36	.375	.312	.875	2.062	2.0625-16N	.500	2.813	2.312	3.797	3.844	II
10-10133X-372	36	1.825	1.700	2.438	2.312	2.0625-16N	.672	3.500	2.312	4.656	13.688	III
10-10133X-373	36	1.375	1.250	2.000	2.062	2.0625-16N	.562	3.246	2.312	4.292	9.688	I
10-10133X-374	36	1.562	1.437	2.250	2.312	2.0625-16N	.562	3.308	2.312	4.354	11.188	III
10-10133X-375	36	1.730	1.605	2.438	2.312	2.0625-16N	.672	3.500	2.312	4.656	13.688	III
10-10133X-376	36	.530	.441	1.000	1.875	2.0625-16N	.562	2.875	2.312	3.921	4.688	II
10-10133X-377	36	1.130	1.005	1.750	2.062	2.0625-16N	.562	3.184	2.312	4.230	7.188	II
10-10133X-378	36	1.180	1.055	1.750	2.062	2.0625-16N	.562	3.184	2.312	4.230	8.188	II
10-10133X-379	36	1.595	1.470	2.250	2.312	2.0625-16N	.562	3.308	2.312	4.354	11.688	III
10-10133X-401	40	1.310	1.200	1.750	2.312	2.3125-16N	.562	3.184	2.562	4.230	8.688	II
10-10133X-402	40	1.656	1.531	2.250	2.312	2.3125-16N	.562	3.308	2.562	4.354	12.688	I
10-10133X-403	40	1.101	.984	1.500	2.312	2.3125-16N	.438	3.121	2.562	4.167	7.688	II
10-10133X-404	40	1.562	1.437	2.250	2.312	2.3125-16N	.562	3.308	2.562	4.354	11.188	I
10-10133X-405	40	1.375	1.250	2.000	2.312	2.3125-16N	.562	3.246	2.562	4.292	9.688	II
10-10133X-406	40	1.180	1.099	1.750	2.312	2.3125-16N	.562	3.184	2.562	4.230	8.188	II
10-10133X-407	40	1.900	1.775	2.438	2.500	2.3125-16N	.672	3.469	2.562	4.625	13.688	III
10-10133X-408	40	1.730	1.605	2.438	2.500	2.3125-16N	.672	3.469	2.562	4.625	13.688	III
10-10133X-409	40	1.825	1.700	2.438	2.500	2.3125-16N	.672	3.469	2.562	4.625	13.688	III
10-10133X-410	40	1.984	1.859	2.438	2.500	2.3125-16N	.672	3.469	2.562	4.625	13.688	III
10-10133X-411	40	1.445	1.320	2.000	2.312	2.3125-16N	.562	3.246	2.562	4.292	9.688	II
10-10133X-412	40	2.062	1.937	2.750	2.500	2.3125-16N	.672	3.500	2.562	4.656	14.188	III
10-10133X-413	40	2.100	1.955	2.750	2.500	2.3125-16N	.672	3.500	2.562	4.656	14.188	III
10-10133X-414	40	2.145	2.000	2.750	2.500	2.3125-16N	.672	3.500	2.562	4.656	14.188	III
10-10133X-415	40	.957	.857	1.250	2.125	2.3125-16N	.562	3.063	2.562	4.109	7.188	II
10-10133X-416	40	1.230	1.103	1.750	2.312	2.3125-16N	.562	3.184	2.562	4.230	8.188	II
10-10133X-417	40	1.055	.958	1.500	2.312	2.3125-16N	.562	3.121	2.562	4.167	7.688	II
10-10133X-418	40	.630	.567	1.250	2.250	2.3125-16UN	.562	3.063	2.562	4.109	6.688	II
10-10133X-441	44	2.170	2.025	2.750	2.625	2.6250-16UN	.672	3.609	2.875	4.953	17.188	III
10-10133X-442	44	2.145	2.000	2.750	2.625	2.6250-16UN	.672	3.547	2.875	4.891	14.188	III
10-10133X-443	44	2.250	2.105	2.750	2.625	2.6250-16UN	.672	3.609	2.875	4.953	17.188	III
10-10133X-445	44	1.130	1.005	1.750	2.625	2.6250-16UN	.562	3.969	2.875	5.203	7.188	II
10-10133X-446	44	1.109	.984	1.500	2.500	2.6250-16UN	.562	3.905	2.875	5.140	7.688	II
10-10133X-449	44	1.445	1.320	2.000	2.562	2.6250-16UN	.562	4.031	2.875	5.265	9.688	II
10-10133X-481	48	1.900	1.775	2.438	2.812	2.8750-16N	.562	3.203	3.125	4.547	13.688	II
10-10133X-482	48	2.000	1.867	2.750	2.969	2.8750-16N	.672	4.281	3.125	5.625	14.188	II
10-10133X-483	48	2.250	2.105	2.750	2.750	2.8750-16N	.672	4.406	3.125	5.750	17.188	I
10-10133X-484	48	2.170	2.025	2.750	2.750	2.8750-16N	.672	4.406	3.125	5.750	17.188	I

\*For complete order number see pages 4 and 5.

# QWL – accessories

## 10-113637

### cable sealing adapter (with woven strain relief)

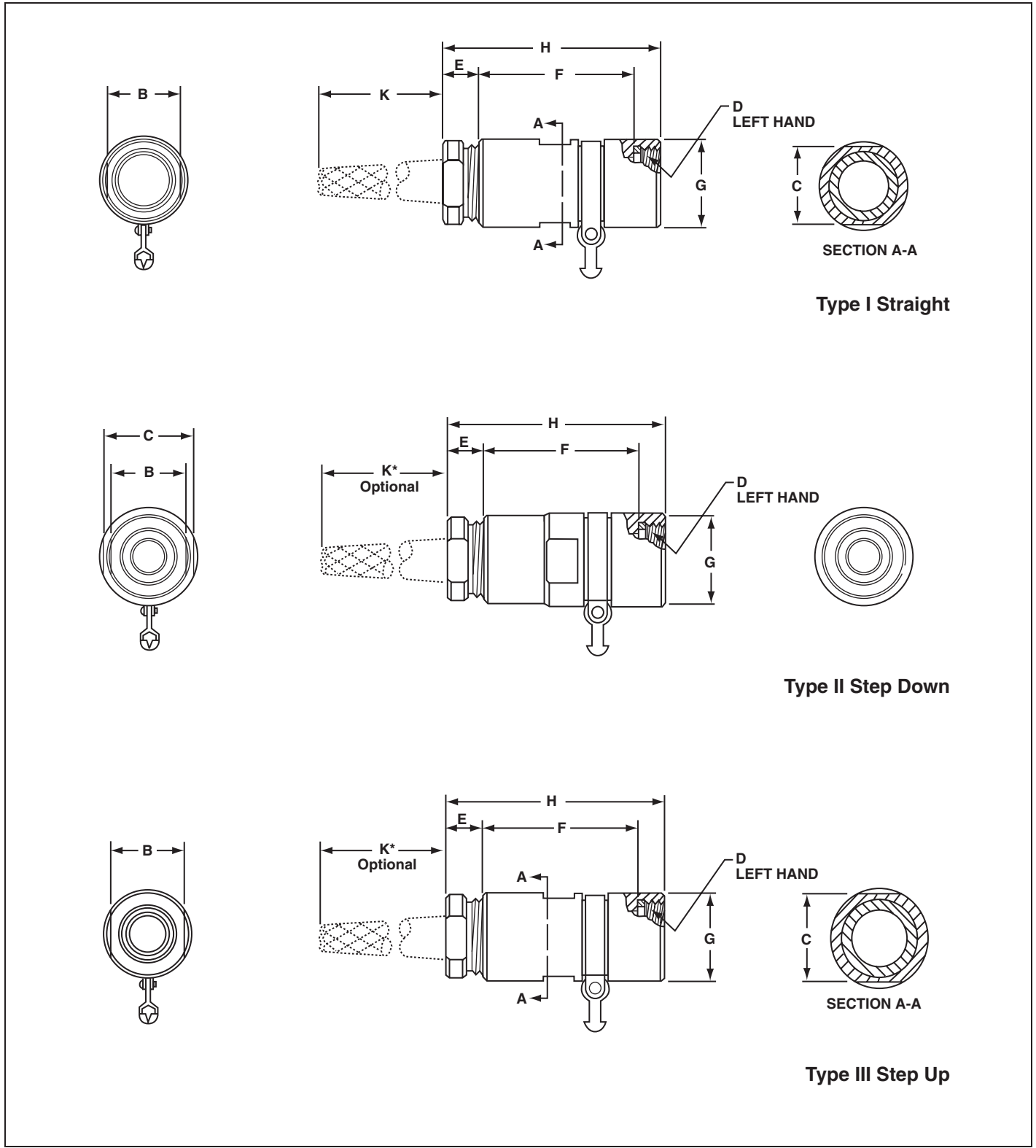

# QWL – accessories

## 10-113637

### cable sealing adapter (with woven strain relief)

All dimensions are for reference only.

Part Number*	Used With Shell Size	Cable Range		B +.000 -.010	C +.010 -.000	D Thread Class 2B-LH	E Free ±.035	F +.010 -.020	G Dia. +.010 -.020	H ±.045	K Free Approx.	Type
		Max. Dia.	Min. Dia.									
10-113637-141	14S	.337	.281	.750	.750	.7500-20UNEF	.500	5.282	.938	6.094	3.344	I
10-113637-142	14S	.405	.316	1.000	1.000	.7500-20UNEF	.562	5.500	.938	6.374	3.688	III
10-113637-143	14S	.530	.441	1.000	1.000	.7500-20UNEF	.562	5.500	.938	6.374	4.688	III
10-113637-144	14S	.463	.406	.875	.938	.7500-20UNEF	.500	5.344	.938	6.156	4.344	III
10-113637-171	16	.699	.605	1.062	1.125	.8750-20UNEF	.562	5.563	1.062	6.609	6.188	III
10-113637-172	16	.530	.441	1.000	1.000	.8750-20UNEF	.562	5.500	1.062	6.546	4.688	III
10-113637-181	18	.828	.715	1.125	1.250	1.0000-20UNEF	.562	6.657	1.188	7.703	6.688	III
10-113637-201	20	.750	.637	1.250	1.312	1.1250-18NEF	.562	6.000	1.312	7.046	6.688	III
10-113637-202	20	.984	.875	1.500	1.625	1.1250-18NEF	.562	6.750	1.312	7.796	7.188	III
10-113637-203	20	.900	.791	1.250	1.312	1.1250-18UNEF	.562	6.000	1.312	7.046	7.188	III
10-113637-221	22	.750	.637	1.250	1.312	1.2500-18NEF	.562	6.000	1.438	7.046	6.688	III
10-113637-222	22	.699	.605	1.062	1.312	1.2500-18NEF	.562	5.063	1.438	6.109	6.188	II
10-113637-223	22	1.055	.958	1.500	1.625	1.2500-18NEF	.562	6.750	1.438	7.796	7.688	III
10-113637-224	22	1.828	.715	1.125	1.250	1.2500-18NEF	.562	5.625	1.438	6.671	6.688	I
10-113637-225	22	.589	.511	1.000	1.250	1.2500-18NEF	.562	5.500	1.438	6.546	5.188	II
10-113637-241	24	.957	.857	1.250	1.375	1.3750-18NEF	.562	6.000	1.562	7.046	7.188	I
10-113637-242	24	.750	.637	1.250	1.375	1.3750-18NEF	.562	6.000	1.562	7.046	6.688	I
10-113637-243	24	1.101	.984	1.500	1.625	1.3750-18NEF	.562	6.750	1.562	7.796	7.688	III
10-113637-244	24	1.000	.875	1.500	1.625	1.3750-18NEF	.562	6.750	1.562	7.796	7.188	III
10-113637-245	24	1.180	1.055	1.750	1.812	1.3750-18NEF	.562	6.813	1.562	7.859	8.188	III
10-113637-246	24	.805	.692	1.250	1.375	1.3750-18NEF	.562	6.000	1.562	7.046	6.688	I
10-113637-281	28	1.000	.875	1.500	1.562	1.6250-18NEF	.562	6.750	1.812	7.796	7.188	I
10-113637-282	28	1.900	1.775	2.438	2.438	1.6250-18NEF	.672	8.125	1.812	9.281	13.688	III
10-113637-283	28	1.375	1.250	2.000	2.000	1.6250-18NEF	.562	6.875	1.812	7.921	9.688	III
10-113637-284	28	.750	.637	1.250	1.562	1.6250-18NEF	.562	5.750	1.812	6.796	6.688	II
10-113637-285	28	1.101	.984	1.500	1.562	1.6250-18NEF	.562	6.750	1.812	7.796	7.688	I
10-113637-286	28	1.130	1.005	1.750	1.875	1.6250-18NEF	.562	6.813	1.812	7.859	7.188	III
10-113637-287	28	.900	.791	1.250	1.562	1.6250-18NEF	.562	5.750	1.812	6.796	7.188	II
10-113637-288	28	1.427	1.320	2.000	2.000	1.6250-18NEF	.562	6.875	1.812	7.921	9.688	III
10-113637-289	28	1.180	1.099	1.750	1.875	1.6250-18NEF	.562	6.812	1.812	7.858	8.188	III
10-113637-290	28	1.055	.958	1.500	1.562	1.6250-18NEF	.562	6.750	1.812	7.796	7.688	I
10-113637-291	28	.957	.857	1.250	1.562	1.6250-18NEF	.562	5.750	1.812	6.796	7.188	II
10-113637-292	28	1.310	1.200	1.750	1.875	1.6250-18NEF	.562	6.813	1.812	7.859	8.688	III
10-113637-293	28	.530	.441	1.000	1.625	1.6250-18NEF	.562	6.500	1.812	7.546	4.688	II
10-113637-294	28	1.230	1.105	1.750	1.875	1.6250-18NEF	.562	6.813	1.812	7.859	8.188	III
10-113637-295	28	.630	.535	1.250	1.562	1.6250-18NEF	.562	5.750	1.812	6.796	5.688	II

\*For complete order number see pages 4 and 5.

# QWL – accessories

## 10-113637

### cable sealing adapter (with woven strain relief)

All dimensions are for reference only.

Part Number*	Used With Shell Size	Cable Range		B +.000 -.010	C +.010 -.000	D Thread Class 2B-LH	E Free ±.035	F +.010 -.020	G Dia. +.010 -.020	H ±.045	K Free Approx.	Type
		Max. Dia.	Min. Dia.									
10-113637-321	32	.828	.715	1.125	1.844	1.8750-16N	.594	7.625	2.062	8.703	6.688	II
10-113637-322	32	1.310	1.200	1.750	1.812	1.8750-16UN	.562	6.812	2.062	7.858	8.688	I
10-113637-323	32	1.130	1.005	1.750	1.812	1.8750-16UN	.562	6.812	2.062	7.858	7.188	I
10-113637-324	32	1.375	1.250	2.000	2.000	1.8750-16UN	.562	7.875	2.062	8.921	9.688	III
10-113637-325	32	1.445	1.320	2.000	2.000	1.8750-16UN	.562	7.875	2.062	8.921	9.688	III
10-113637-326	32	1.180	1.099	1.750	1.812	1.8750-16UN	.562	6.812	2.062	7.858	8.188	I
10-113637-327	32	1.656	1.531	2.250	2.250	1.8750-16UN	.562	7.141	2.062	8.187	12.688	III
10-113637-328	32	.970	.857	1.250	1.844	1.8750-16UN	.562	6.688	2.062	7.734	7.188	II
10-113637-361	36	1.375	1.250	2.000	2.000	2.0625-16N	.562	6.875	2.312	7.921	9.688	I
10-113637-362	36	1.000	.875	1.500	2.000	2.0625-16N	.562	6.750	2.312	7.796	7.188	II
10-113637-363	36	1.920 x 1.140 oval	1.920 x 1.140 oval	2.438	2.438	2.0625-16N	.672	8.125	2.312	9.281	13.688	III
10-113637-364	36	1.230	1.105	1.750	2.000	2.0625-16N	.562	6.813	2.312	7.859	8.188	II
10-113637-365	36	1.562	1.437	2.250	2.250	2.0625-16N	.562	6.938	2.312	7.984	11.188	III
10-113637-366	36	1.656	1.531	2.250	2.250	2.0625-16N	.562	6.938	2.312	7.984	11.188	III
10-113637-367	36	1.445	1.320	2.000	2.000	2.0625-16N	.562	6.875	2.312	7.921	9.688	I
10-113637-368	36	1.825	1.700	2.438	2.500	2.0625-16N	.672	9.125	2.312	9.281	13.688	III
10-113637-369	36	1.895	1.775	2.438	2.438	2.0625-16N	.672	8.125	2.312	9.281	13.688	III
10-113637-370	36	1.730	1.605	2.438	2.438	2.0625-16N	.672	8.125	2.312	9.281	13.688	III
10-113637-371	36	1.310	1.200	1.750	2.000	2.0625-16N	.562	6.813	2.312	7.859	8.688	II
10-113637-401	40	1.906	1.761	2.750	2.438	2.3125-16N	.672	8.125	2.562	9.281	14.188	III
10-113637-402	40	1.940	1.815	2.438	2.438	2.3125-16N	.672	8.125	2.562	9.281	13.688	III
10-113637-403	40	1.900	1.775	2.438	2.438	2.3125-16N	.672	8.125	2.562	9.281	13.688	III
10-113637-404	40	1.825	1.700	2.438	2.438	2.3125-16N	.672	8.125	2.562	9.281	13.688	III
10-113637-405	40	1.310	1.200	1.750	2.250	2.3125-16N	.562	7.813	2.562	8.859	8.688	II
10-113637-406	40	1.180	1.099	1.750	2.250	2.3125-16N	.562	7.813	2.562	8.859	8.188	II
10-113637-407	40	1.230	1.105	1.750	2.250	2.3125-16N	.562	7.813	2.562	8.859	8.188	II
10-113637-408	40	1.656	1.531	2.250	2.250	2.3125-16N	.562	7.938	2.562	8.984	11.188	I
10-113637-410	40	2.145	2.000	2.750	2.438	2.3125-16N	.672	8.125	2.562	9.281	14.188	III
10-113637-411	40	1.984	1.859	2.438	2.438	2.3125-16N	.672	8.125	2.562	9.281	13.688	III
10-113637-412	40	1.940	1.815	2.438	2.438	2.3125-16N	.672	11.125	2.562	12.281	13.688	III
10-113637-413	40	1.984	1.859	2.438	2.438	2.3125-16N	.672	11.125	2.562	12.281	13.688	III
10-113637-414	40	2.100	1.955	2.750	2.625	2.3125-16N	.672	12.000	2.562	13.156	14.188	III
10-113637-415	40	1.562	1.437	2.250	2.250	2.3125-16N	.562	7.938	2.562	8.984	11.188	I
10-113637-416	40	1.445	1.320	2.000	2.312	2.3125-16N	.562	6.875	2.562	7.921	9.688	II
10-113637-417	40	1.375	1.250	2.000	2.312	2.3125-16N	.562	6.875	2.562	7.921	9.688	II

\*For complete order number see pages 4 and 5.



# QWL – accessories

## 10-113637

### cable sealing adapter (with woven strain relief)

All dimensions are for reference only.

Part Number*	Used With Shell Size	Cable Range		B +.000 -.010	C +.010 -.000	D Thread Class 2B-LH	E Free ±.035	F +.010 -.020	G Dia +.010 -.020	H ±.045	K Free† Approx.	Type
		Max Dia	Min Dia									
10-113637-441	44	2.100	1.955	2.750	2.750	2.6250-16UN	.672	8.125	2.875	9.469	14.188	III
10-113637-442	44	2.250	2.105	2.750	2.875	2.6250-16UN	.672	8.188	2.875	9.531	17.188	III
10-113637-443	44	2.000	1.867	2.750	2.750	2.6250-16UN	.672	8.125	2.875	9.469	14.188	III
10-113637-444	44	1.500	1.375	2.250	2.500	2.6250-16UN	.562	7.938	2.875	9.171	11.188	II
10-113637-445	44	1.730	1.605	2.438	2.750	2.6250-16UN	.672	8.125	2.875	9.469	13.688	II
10-113637-446	44	.750	.637	1.250	2.625	2.6250-16UN	.562	6.688	2.875	7.921	6.688	II
10-113637-447	44	1.825	1.700	2.438	2.750	2.6250-16UN	.672	8.125	2.875	9.469	13.688	II
10-113637-448	44	2.145	2.000	2.750	2.750	2.6250-16UN	.672	8.125	2.875	9.469	14.188	III
10-113637-449	44	2.170	2.025	2.750	2.875	2.6250-16UN	.672	8.188	2.875	9.532	17.188	III
10-113637-450	44	1.375	1.250	2.000	2.625	2.6250-16UN	.562	7.875	2.875	9.109	9.688	II
10-113637-481	48	2.250	2.105	2.750	2.750	2.8750-16N	.672	8.188	3.125	9.532	14.688	I
10-113637-482	48	2.500	2.355	2.875	2.875	2.8750-16N	.672	8.188	3.125	9.532	18.188	III
10-113637-483	48	2.375	2.230	2.875	2.875	2.8750-16N	.672	8.188	3.125	9.532	18.188	III
10-113637-484	48	2.145	2.000	2.750	2.875	2.8750-16N	.672	8.125	3.125	9.469	14.188	II
10-113637-485	48	2.000	1.867	2.750	2.875	2.8750-16N	.672	8.125	3.125	9.469	14.188	II
10-113637-486	48	1.656	1.531	2.250	2.750	2.8750-16UN	.562	7.937	3.125	9.171	12.688	II

\*For complete order number see pages 4 and 5.

# QWL – accessories adapter, cable clamp

**10-113196-XX  
adapter**

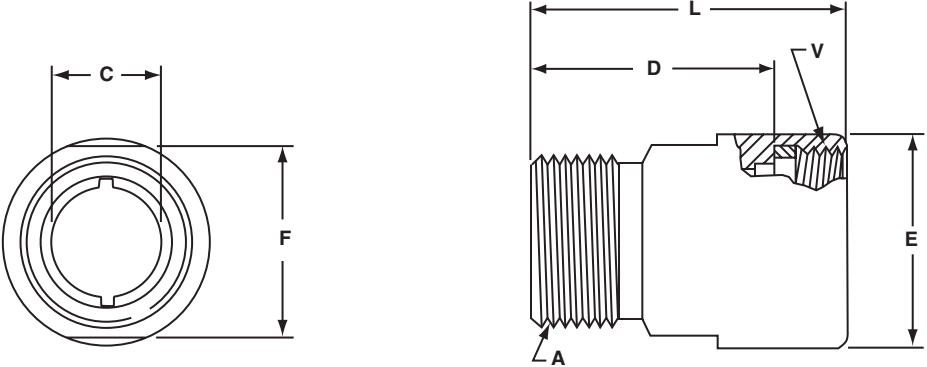

**10-749XX-( )  
cable clamp**

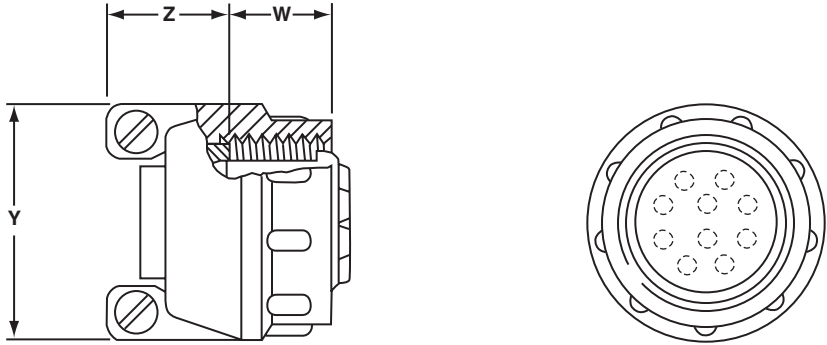

This cable clamp is designed to be used with specific QWL insert arrangements. The locations, quantity, and sizes of holes in the clamp grommet must correspond to those in the connector for an effective moisture seal without wire crossing. Contact Amphenol, Sidney, NY, for grommet availability. Example: 10-107618-4P must use 10-74918-4 clamp.

# QWL – accessories

## adapter, cable clamp, sealing plugs

All dimensions for reference only.

Shell Size	Adapter Part Number*	Clamp Part Number*	A Thread Class 2A	C +.010 -.000	D Dia. +.010 -.020	E Dia. +.010 -.020	F ±.010	L ±.010	V Thread Class 2B-LH	W Min. Thd. Engage	Y Max.	Z Max.
10S	10-113196-10	10-74910-( )	.500-28UNEF	.203	.922	.625	.562	1.234	.500-28UNEF	.519	.807	.529
12S	10-113196-12	10-74912-( )	.625-24NEF	.328	.969	.750	.688	1.281	.625-24NEF	.519	.901	.524
12	10-113196-13	10-74913-( )	.625-24NEF	.328	.954	.750	.688	1.438	.625-24NEF	.519	.901	.524
14S	10-113196-14	10-74914-( )	.750-20UNEF	.453	1.094	.875	.812	1.406	.750-20UNEF	.519	1.026	.524
14	10-113196-15	10-74915-( )	.750-20UNEF	.453	.954	.875	.812	1.438	.750-20UNEF	.519	1.026	.524
16S	10-113196-16	10-74916-( )	.875-20UNEF	.578	1.094	1.000	.938	1.406	.875-20UNEF	.519	1.119	.524
16	10-113196-17	10-74917-( )	.875-20UNEF	.578	1.016	1.000	.938	1.500	.875-20UNEF	.519	1.119	.524
18	10-113196-18	10-74918-( )	1.000-20UNEF	.676	1.141	1.188	1.062	1.625	1.000-20UNEF	.519	1.229	.556
20	10-113196-20	10-74920-( )	1.1875-18NEF	.801	1.094	1.312	1.250	1.578	1.125-18NEF	.505	1.479	.666
22	10-113196-22	10-74922-( )	1.1875-18NEF	.906	1.141	1.438	1.250	1.625	1.250-18NEF	.519	1.479	.666
24	10-113196-24	10-74924-( )	1.4375-18NEF	1.016	1.094	1.562	1.500	1.578	1.375-18NEF	.519	1.666	.666
28	10-113196-28	10-74928-( )	1.4375-18NEF	1.130	1.235	1.812	1.500	1.719	1.625-18NEF	.519	1.666	.666
32	10-113196-32	10-74932-( )	1.7500-18NS	1.438	1.204	2.062	1.875	1.688	1.875-16N	.519	2.135	.805
36	10-113196-36	10-74936-( )	2.000-18NS	1.678	1.266	2.250	2.125	1.750	2.0625-16N	.738	2.260	.805
40	10-113196-40	10-74940-( )	2.2500-16UN	1.914	1.266	2.500	2.375	1.750	2.3125-16N	.738	2.510	.805

\*For complete order number see page 5. Clamp 10-749XX-( ) has a bright cadmium finish. An olive drab cadmium plate finish is available by order number 71-749XX-( ). To complete clamp order number, add connector insert arrangement number.

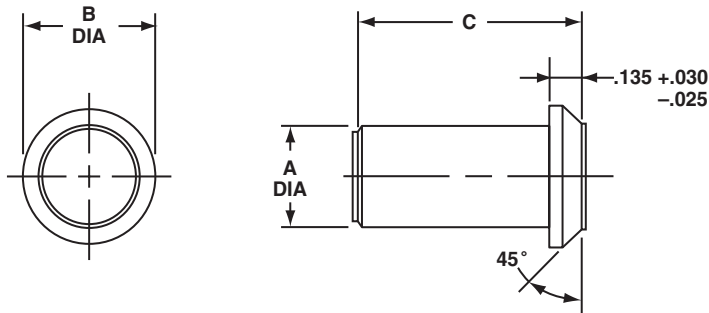

### SEALING PLUG MS27488-XX 10-405996-XX

Order No.	Contact Size	MS Number	Wire Size	Color Code	B ±.005	C ±.010	A Dia. ±.010
10-405996-16	16	27488-16	20-16	Blue	.133	.564*	.083
10-405996-12	12	27488-12	14-12	Yellow	.171	.564*	.121
10-405996-8	8	27488-8	10-8	White	.315	.470	.185
10-405996-4	4	27488-4	4-6	Blue	.415	.470	.310
10-405996-0	0	27488-0	0-2	Yellow	.605	1.000	.440

\*±.020

Sealing plugs are used to fill unused holes in multi-holed grommet configurations

# QWL – accessories adapter, cable clamp

10-113138-XX  
adapter

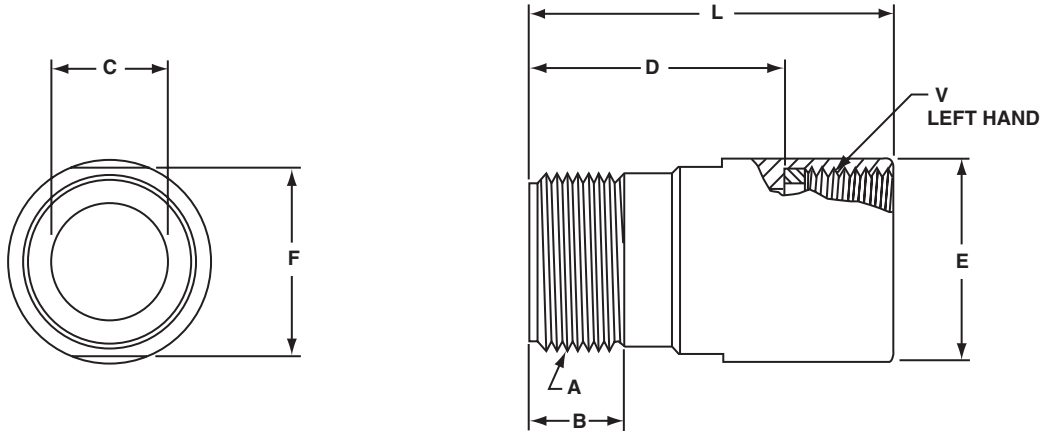

M85049/2-( )C  
cable clamp

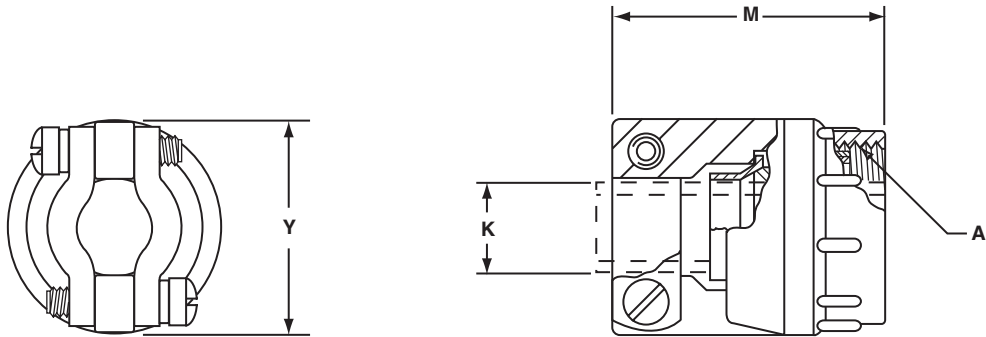

# QWL – accessories

## adapter, cable clamp, sleeve

Shell Size	Adapter Part Number*	Clamp MS Part Number*	A Thread Class 2A (Plated)	B Min Full Thd	C Dia +.000 - .010	D ±.020	E Dia +.010 - .020	F ±.010	K Dia Cable Range		L Max	M Max	V Thread Class 2B-LH	Y Max
									Free	Closed				
12	10-113138-12	M85049/2-4C	.625-24UNEF	.422	.386	1.078	.750	.688	.302	.094	1.390	1.375	.625-24NEF	.906
	10-113138-13	M85049/2-4C	.625-24NEF	.422	.386	1.125	.750	.688			1.609		.625-24NEF	
14	10-113138-14	M85049/2-6C	.750-20UNEF	.422	.500	1.078	.875	.812	.428	.230	1.390	1.375	.750-20UNEF	1.031
	10-113138-15	M85049/2-6C	.750-20UNEF	.422	.500	1.125	.875	.812			1.609		.750-20UNEF	
16	10-113138-16	M85049/2-8C	.875-20UNEF	.422	.625	1.078	1.000	.938	.515	.316	1.390	1.375	.875-20UNEF	1.125
	10-113138-17	M85049/2-8C	.875-20UNEF	.422	.625	1.125	1.000	.938			1.609		.875-20UNEF	
18	10-113138-18	M85049/2-10C	1.000-20UNEF	.422	.752	1.125	1.188	1.062	.614	.378	1.609	1.437	1.000-20UNEF	1.234
20	10-113138-20	M85049/2-12C	1.1875-18UNEF	.422	.891	1.125	1.312	1.250	.738	.445	1.609	1.437	1.125-18NEF	1.484
22	10-113138-22	M85049/2-12C	1.1875-18NEF	.422	.891	1.125	1.438	1.250	.738	.445	1.609	1.437	1.250-18NEF	1.484
24	10-113138-24	M85049/2-16C	1.4375-18UNEF	.422	1.111	1.125	1.562	1.500	.926	.611	1.609	1.562	1.375-18NEF	1.671
28	10-113138-28	M85049/2-16C	1.4375-18NEF	.422	1.111	1.297	1.812	1.500	.926	.611	1.781	1.562	1.625-18NEF	1.671
32	10-113138-32	M85049/2-20C	1.750-18UNS	.484	1.422	1.297	2.062	1.875	1.200	.922	1.781	1.812	1.875-16UN	2.188
36	10-113138-36	M85049/2-24C	2.000-18UNS	.562	1.672	1.297	2.250	2.125	1.363	.922	1.781	2.062	2.0625-16N	2.344
40	10-113138-40	M85049/2-28C	2.250-16UN	.562	1.914	1.297	2.500	2.375	1.611	1.180	1.781	2.062	2.3125-16N	2.594
44	10-113138-44	M85049/2-32C	2.500-16UN	.562	2.142	1.297	2.812	2.625	1.865	1.427	1.781	2.188	2.625-16UN	2.812

**MS3420-( )A sleeve**

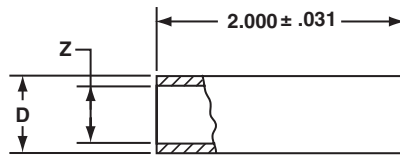

Shell Size	Sleeve MS Part Number	D Dia. ±.016	Z Dia	
			Free ±.016	Closed
12	MS3420-4A	.302	.219	.010
14	MS3420-4A	.302	.219	.020
	MS3420-6A	.427	.312	.114
16	MS3420-6A	.427	.312	.085
	MS3420-8A	.531	.438	.220
18	MS3420-6A	.427	.312	.085
	MS3420-10A	.615	.438	.200
20	MS3420-10A	.615	.438	.177
	MS3420-12A	.740	.541	.270
22	MS3420-10A	.615	.438	.177
	MS3420-12A	.740	.541	.270
24	MS3420-8A	.531	.438	.186
	MS3420-12A	.740	.541	.260
	MS3420-16A	.927	.750	.433
26	MS3420-8A	.531	.438	.186
	MS3420-12A	.740	.541	.260
	MS3420-16A	.927	.750	.433
32	MS3420-12A	.740	.541	.273
	MS3420-16A	.927	.750	.442
	MS3420-20A	1.240	.938	.620
36	MS3420-16A	.927	.750	.358
	MS3420-20A	1.240	.938	.504
	MS3420-24A	1.365	1.125	.682
40	MS3420-16A	.927	.750	.368
	MS3420-20A	1.240	.938	.514
	MS3420-28A	1.614	1.250	.816
44	MS3420-20A	1.240	.938	.638
	MS3420-28A	1.614	1.250	.897
	MS3420-32A	1.865	1.625	1.229

Sleeve not supplied as part of MS3057-( )C assembly. Order separately by part number shown.

# QWL – accessories

## protection caps

10-101046-( ), 10-101531-( )  
plug protective covers

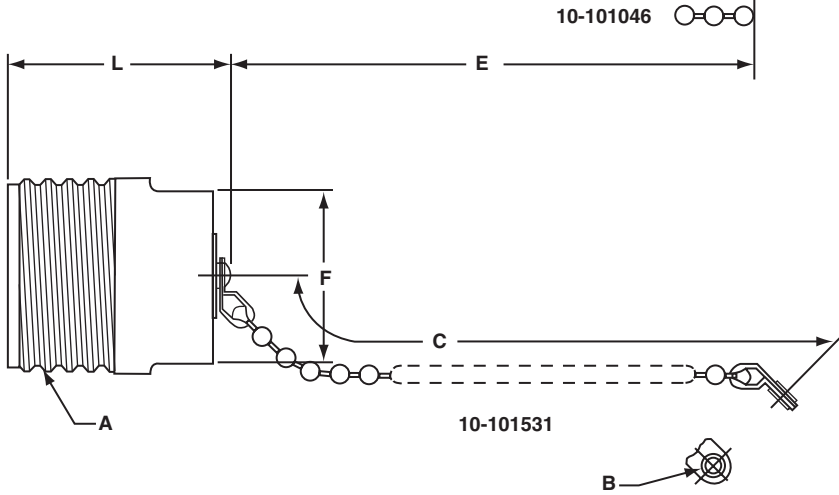

10-101063-( ), 10-101048-( )  
receptacle protective covers

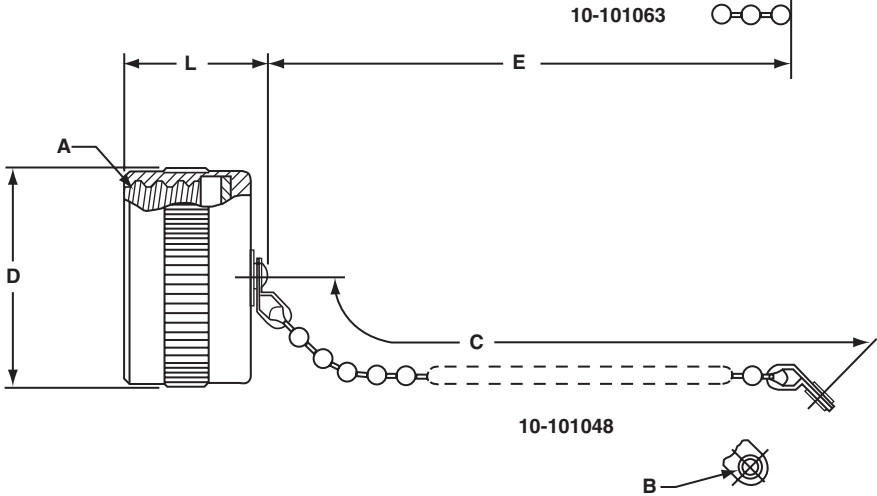

# QWL – accessories protection caps

All dimensions for reference only.

Shell Size	Without Eyelet End Part Number*	With Eyelet End Part Number*	A Thread Class 2A	B Dia +.010 -.000	C Approx.	E Approx.	F Flat ±.010	L Max.
10	10-101046-10	10-101531-10	.6250-0.05P-0.1L-DS	.125	3.000	3.375	.500	1.250
12	10-101046-12	10-101531-12	.7500-0.1P-0.2L-DS	.125	3.500	3.875	.625	1.438
14	10-101046-14	10-101531-14	.8750-0.1P-0.2L-DS	.125	3.500	3.875	.750	1.438
16	10-101046-16	10-101531-16	1.0000-0.1P-0.2L-DS	.140	3.500	3.875	.875	1.438
18	10-101046-18	10-101531-18	1.1250-0.1P-0.2L-DS	.140	3.500	4.000	1.000	1.438
20	10-101046-20	10-101531-20	1.2500-0.1P-0.2L-DS	.193	4.000	4.500	1.062	1.438
22	10-101046-22	10-101531-22	1.3750-0.1P-0.2L-DS	.193	4.000	4.500	1.125	1.438
24	10-101046-24	10-101531-24	1.5000-0.1P-0.2L-DS	.193	4.500	5.000	1.250	1.438
28	10-101046-28	10-101531-28	1.7500-0.1P-0.2L-DS	.193	4.500	5.000	1.500	1.438
32	10-101046-32	10-101531-32	2.0000-0.1P-0.2L-DS	.193	5.000	5.500	1.750	1.438
36	10-101046-36	10-101531-36	2.2500-0.1P-0.2L-DS	.193	5.000	5.500	2.000	1.438
40	10-101046-40	10-101531-40	2.5000-0.1P-0.2L-DS	.193	5.000	5.500	2.250	1.438
44	10-101046-44	10-101531-44	2.7500-0.1P-0.2L-DS	.193	6.000	6.000	2.500	1.438
48	10-101046-48	10-101531-48	3.0000-0.1P-0.2L-DS	.193	6.000	6.000	2.750	1.438

\*For complete order number see page 5.

All dimensions for reference only.

Shell Size	Without Eyelet End Part Number*	With Eyelet End Part Number*	A Thread Class 2B	B Dia +.010 -.000	C Approx.	D Dia. Max.	E Approx.	L Max.
10	10-101063-10	10-101048-10	.6250-0.05P-0.1L-DS	.140	3.000	.844	3.375	.750
12	10-101063-12	10-101048-12	.7500-0.1P-0.2L-DS	.140	3.500	.969	3.875	.750
14	10-101063-14	10-101048-14	.8750-0.1P-0.2L-DS	.140	3.500	1.094	3.875	.750
16	10-101063-16	10-101048-16	1.0000-0.1P-0.2L-DS	.140	3.500	1.219	3.875	.750
18	10-101063-18	10-101048-18	1.1250-0.1P-0.2L-DS	.193	3.500	1.344	4.000	.969
20	10-101063-20	10-101048-20	1.2500-0.1P-0.2L-DS	.193	4.000	1.469	4.500	.969
22	10-101063-22	10-101048-22	1.3750-0.1P-0.2L-DS	.193	4.000	1.562	4.500	.969
24	10-101063-24	10-101048-24	1.5000-0.1P-0.2L-DS	.193	4.500	1.688	5.000	.969
28	10-101063-28	10-101048-28	1.7500-0.1P-0.2L-DS	.193	4.500	1.938	5.000	.969
32	10-101063-32	10-101048-32	2.0000-0.1P-0.2L-DS	.193	5.000	2.219	5.500	.969
36	10-101063-36	10-101048-36	2.2500-0.1P-0.2L-DS	.193	5.000	2.469	5.500	.969
40	10-101063-40	10-101048-40	2.5000-0.1P-0.2L-DS	.193	5.000	2.719	5.500	.969
44	10-101063-44	10-101048-44	2.7500-0.1P-0.2L-DS	.193	6.000	2.969	6.000	.969
48	10-101063-48	10-101048-48	3.0000-0.1P-0.2L-DS	.193	6.000	3.219	6.000	.969

\*For complete order number see page 5.

# QWL – accessories

## flange gasket, grip banding clamp

10-36675-( )  
10-40450-( )  
flange gaskets

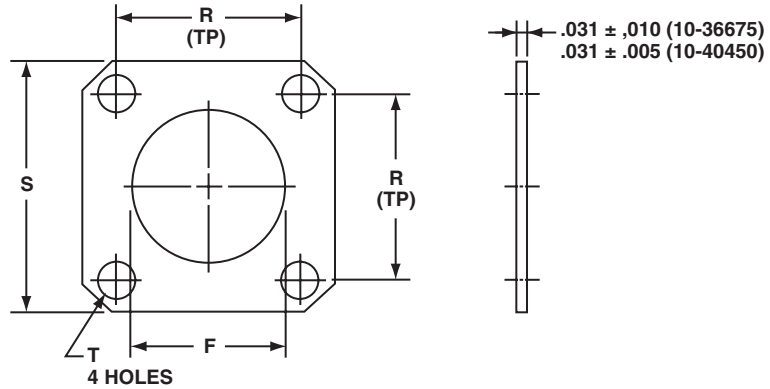

All dimensions for reference only.

Part Number*	Part Number*	Shell Size	F Dia. +.016 - .000	R ±.010	S +.016 - .000	T Dia. ±.010
10-36675-10	10-40450-10	10	.625	.719	1.000	.172
10-36675-12	10-40450-12	12	.750	.813	1.094	.172
10-36675-14	10-40450-14	14	.875	.906	1.188	.172
10-36675-16	10-40450-16	16	1.000	.969	1.281	.172
10-36675-18	10-40450-18	18	1.125	1.063	1.375	.203
10-36675-20	10-40450-20	20	1.250	1.156	1.500	.203
10-36675-22	10-40450-22	22	1.375	1.250	1.625	.203
10-36675-24	10-40450-24	24	1.500	1.375	1.750	.203
10-36675-28	10-40450-28	28	1.750	1.563	2.000	.203
10-36675-32	10-40450-32	32	2.000	1.750	2.250	.219
10-36675-36	10-40450-36	36	2.188	1.938	2.500	.219
10-36675-40	10-40450-40	40	2.438	2.188	2.750	.219
10-36675-44	10-40450-44	44	2.688	2.375	3.000	.219
10-36675-48	10-40450-48	48	2.938	2.625	3.250	.219

\*For complete order number see page 5.

10-183249-( )  
grip banding clamp

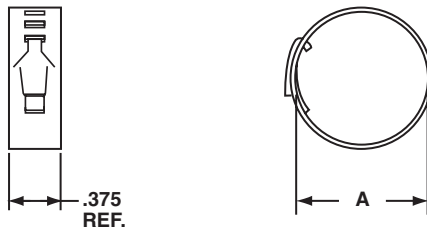

All dimensions for reference only.

Part Number*	A Dia.	
	Max.	Min.
10-183249-10	1.125	.812
10-183249-11	1.312	.938
10-183249-12	1.500	1.125
10-183249-13	1.688	1.312
10-183249-14	1.875	1.500
10-183249-15	2.062	1.688
10-183249-16	2.250	1.875
10-183249-17	2.438	2.062
10-183249-18	2.625	2.250
10-183249-19	2.812	2.438
10-183249-20	3.000	2.625

\*For complete order number see page 5.



# QWL

## crimp contacts

Machined from copper alloy and silver-plated for maximum corrosion resistance, with a minimum millivolt drop and a maximum current carrying capacity, the size 16 and 12 socket contacts are of the closed entry design. Crimp contacts are available for all MS insert arrangements and are identified with an Amphenol® proprietary number.

**MS/STANDARD CRIMP CONTACTS**

Part Number	Pin/Socket	Mating End Size	Wire Barrel Size	Allowable Wire Size	Required Wire Adapter Sleeve	Test Current** Amps
10-40553	Pin	16 Short†	16	16	10-74696-6	13
10-40552 or 10-597109-161	Socket			18		10
				20		7.5
				22*		5
10-40557	Pin	16 Long	16	16	10-74696-6	13
10-40556 or 10-597109-171	Socket			18		10
				20		7.5
				22*		5
10-40561	Pin	12	12	12		23
10-40560 or 10-597109-131	Socket			14		17
10-40792	Pin	8	8	8	10-74696-1	46
10-40793	Socket			10*		33
10-40564	Pin	4	4	4	10-74696-2	80
10-40565	Socket			6*		60
10-40562 or 10-581806	Pin	0	0	0		150
10-40563 or 10-581808	Socket			2*		100

\* When using wire adapter sleeve shown.

\*\* Contact ratings as stated are test ratings only. The connector could not withstand full rated current through all contacts continuously. Please note that the electrical data given is not an establishment of electrical safety factors. This is left entirely in the designer's hands as he can best determine which peak voltage, switching surges, transients, etc. can be expected in a particular circuit.

† The 12S, 14S and 16S connectors require short contacts.

**TABLE I**  
**CONTACT ARRANGEMENT SERVICE RATING**

MS Service Rating	Recommended Operating Voltage* at Sea Level		Effective Creepage Distance Nom.	Mechanical Spacing Nom.
	DC	AC (RMS)		
Inst.	250	200	1/16	
A	700	500	1/8	1/16
D	1250	900	3/16	1/8
E	1750	1250	1/4	3/16
B	2450	1750	5/16	1/4
C	4200	3000	1	5/16

\* The values listed in Table I represent operating values which include a generous safety factor. It may be necessary for some applications to exceed the operating voltages listed here. If this is necessary, designers will find Table II useful for determining the degree to which the recommended values of Table I can be exceeded.

**TABLE II**  
**ALTITUDE VOLTAGE DERATING\*\* CHART**

MS Service Rating	Nominal Distance		Standard Sea Level Conditions		Pressure Altitude† 50,000 Feet		Pressure Altitude† 70,000 Feet	
	Airspace	Creepage	Minimum Flashover Voltage AC (RMS)	Test Voltage AC (RMS)	Minimum Flashover Voltage AC (RMS)	Test Voltage AC (RMS)	Minimum Flashover Voltage AC (RMS)	Test Voltage AC (RMS)
Inst.	1/32	1/16	1400	1000	500	400	325	260
A	1/16	1/8	2800	2000	800	600	450	360
D	1/8	3/16	3600	2800	900	675	500	400
E	3/16	1/4	4500	3500	1000	750	550	440
B	1/4	5/16	5700	4500	1100	825	600	480
C	5/16	1	8500	7000	1300	975	700	560

† Not corrected for changes in density due to variations in temperature.

\*\* No attempt has been made to recommend operating voltages. The designer must determine his own operating voltage by the application of a safety factor to the above derating chart to compensate for circuit transients, surges, etc.

# QWL solder contacts

Machined copper alloy contacts in a full range of sizes, with closed entry socket design in the size 12 and 16 contacts. A heavy silver-plated finish is deposited on all MS style solder contacts for maximum corrosion resistance, maximum current carrying capacity and low millivolt drop.

**MS/STANDARD SOLDER CONTACTS\***

Part Number	Pin/Socket	Mating End Size	Wire Barrel Size	Allowable Wire Size	Test Current** Amps
10-40569	Pin	16 Short†	16	16	13
10-597107-161	Socket			18	10
				20	7.5
				22	5
10-40599	Pin	16 Long	16	16	13
10-597107-171	Socket			18	10
				20	7.5
				22	5
10-33646	Pin	12	12	12	23
10-597107-131	Socket			14	17
10-35531	Pin	8	8	8	46
10-35532	Socket			10	33
10-35529	Pin	4	4	4	80
10-35530	Socket			6	60
10-35527	Pin	0	0	0	150
10-35528	Socket			1	125
				2	100

\* Solder Wells Filled

\*\* Contact ratings as stated are test ratings only. The connector could not withstand full rated current through all contacts continuously. Please note that the electrical data given is not an establishment of electrical safety factors. This is left entirely in the designer's hands as he can best determine which peak voltage, switching surges, transients, etc. can be expected in a particular circuit.

† The 12S, 14S and 16S connectors require short contacts.

**TABLE I  
CONTACT ARRANGEMENT SERVICE RATING**

MS Service Rating	Recommended Operating Voltage* at Sea Level		Effective Creepage Distance Nom.	Mechanical Spacing Nom.
	DC	AC (RMS)		
Inst.	250	200	1/16	
A	700	500	1/8	1/16
D	1250	900	3/16	1/8
E	1750	1250	1/4	3/16
B	2450	1750	5/16	1/4
C	4200	3000	1	5/16

\* The values listed in Table I represent operating values which include a generous safety factor. It may be necessary for some applications to exceed the operating voltages listed here. If this is necessary, designers will find Table II useful for determining the degree to which the recommended values of Table I can be exceeded.

**TABLE II  
ALTITUDE VOLTAGE DERATING\*\* CHART**

MS Service Rating	Nominal Distance		Standard Sea Level Conditions		Pressure Altitude† 50,000 Feet		Pressure Altitude† 70,000 Feet	
	Airspace	Creepage	Minimum Flashover Voltage AC (RMS)	Test Voltage AC (RMS)	Minimum Flashover Voltage AC (RMS)	Test Voltage AC (RMS)	Minimum Flashover Voltage AC (RMS)	Test Voltage AC (RMS)
Inst.	1/32	1/16	1400	1000	500	400	325	260
A	1/16	1/8	2800	2000	800	600	450	360
D	1/8	3/16	3600	2800	900	675	500	400
E	3/16	1/4	4500	3500	1000	750	550	440
B	1/4	5/16	5700	4500	1100	825	600	480
C	5/16	1	8500	7000	1300	975	700	560

† Not corrected for changes in density due to variations in temperature.

\*\* No attempt has been made to recommend operating voltages. The designer must determine his own operating voltage by the application of a safety factor to the above derating chart to compensate for circuit transients, surges, etc.

# QWL

## application tools (crimp type)

Complete installation instructions (L-516) for Amphenol® QWL Series Connectors are available on request.

The following data includes information pertaining to the application tools which have been established for crimping, inserting and removing crimp contacts used in QWL Series Connectors.

### Contact Crimping, Insertion & Removal Tools

Crimping Tool	Positioner/ Turret	Contact Size	Contact Style	Insertion Tool	Removal Tool
M22520/1-01	*	16	Pin & Socket	11-7345	11-8250 Kit
M22520/1-01	*	12	Pin & Socket	11-7082	11-8250 Kit
*	*	8	Pin & Socket	11-8220	11-8250 Kit
*	*	4	Pin & Socket	11-7365-4†	Pin11-7370-4† Socket 11-7674-2†
*	*	0	Pin & Socket	11-7365-5†	Pin 11-7370-5† Socket 11-7674-3†

\*Refer to tool manufacturers for appropriate crimp tools or positioner/turret.  
†Tools used with Arbor press 11-7364.

# QWL

## thermocouple contacts

Available from Amphenol is a complete line of cylindrical connectors featuring thermocouple contact insert arrangements. The design of these contacts is such that standard shell components and resilient inserts are used in the assemblies. Thermocouple contacts are available in all arrangements which contain size 12 and 16 pins and sockets, and feature probe-proof, closed entry design for the socket contacts. MS-approved and other commercial arrangements may be ordered with thermocouple contacts substituted for the standard contacts. All thermocouple contact layouts may contain either iron, alumel, chromel, constantan, standard (copper) or brass (dummy) contacts. The resulting assembly will be identified with an Amphenol® part number.

### IDENTIFICATION

For the purpose of wiring identification, thermocouple contacts are marked in accordance with the following color code which agrees with the wire code.

**Chromel. . . . . White**  
**Alumel . . . . . Green**  
**Iron . . . . . Black**  
**Constantan . . . . . Yellow**

This identification is made by means of small dots of stain on solder well end of the contact and is in accordance with the listing shown above.

### WIRE WELL DATA

Contact Size		12	16
Well Inside Diameter	+ .004 - .002	.125	.094
Well Depth	+ .031 - .000	.250	.188
Solder Well Barrel Outside Diameter		.166±.003	.125 <sup>+ .002</sup> - .004

### RECOMMENDED WIRE:

- I Chromel – Alumel: Use wire in accordance with AN-W-29
- II Iron – Constantan: Use wire in accordance with AN-W-8b

# QWL

## thermocouple arrangements

Military connector specifications do not provide for thermocouple contact usage in established MS inserts. Amphe-nol® has established a series of insert arrangements containing thermocouple contacts. Some inserts have been rotated into positions outside those covered by MS

drawings to prevent cross plugging. Available thermocouple arrangements are tabulated on the following pages. Please contact your local sales office or Sidney, NY for additional information regarding thermocouple arrangements particular to your application.

The following abbreviations are used in the contact material column:

Abbreviation	Ir.	Con.	Cu.	Ch.	Al.	Dummy
Material	Iron	Constantan	Copper	Chromel	Alumel	Brass

Shell Size and Arrg.†	Similar To MS Arrg.	Total Con-tacts	Contact Size		Pin Insert Rotation C/W	Contact Material
			12	16		
12S-51	12S-3	2		2	315°	A = Ch.; B = Al.
12S-54	12S-3	2		2	315°	A = Ir.; B = Con.
12S-55	12S-3	2		2	45°	A = Cu.; B = Con.
12S-56	12S-3	2		2	None	A = Al.; B = Ch.
12S-57	12S-3	2		2	60°	A = Ch.; B = Al.
12S-58	12S-3	2		2	120°	A = Ir.; B = Con.
12S-59	12S-3	2		2	None	A = Ir.; B = Con.
12S-60	12S-3	2		2	None	A = Cu.; B = Con.
12S-61	12S-3	2		2	None	A = Ch.; B = Con.
12S-62	12S-3	2		2	None	A = Ch.; B = Al.
12S-64	12S-3	2		2	315°	A = Cu.; B = Con.
12S-65	12S-3	2		2	None	A = Con.; B = Ir.
14S-51	14S-9	2		2	90°	A = Al.; B = Ch.
14S-52	14S-2	4		4	45°	A, B = Cu.; C = Al.; D = Ch.
14S-53	14S-9	2		2	90°	A = Ir.; B = Con.
14S-54	14S-6	6		6	45°	A, C, E = Ir.; B, D, F = Con.
14S-55	14S-2	4		4	45°	A, C = Ir.; B, D = Con.
14S-56	14S-2	4		4	45°	A = Ir.; B = Con.; C, D = Cu.
14S-57	14S-2	4		4	45°	A, C = Al.; B, D = Ch.
14S-58	14S-7	3		3	45°	A = Al.; B = Ch.; C = Cu.
14S-59	14S-9	2		2	90°	A = Cu.; B = Con.
14S-60	14S-9	2		2	*	A = Al.; B = Ch.
14S-61	14S-6	6		6	45°	A = Al.; B = Ch.; C = Ir.; D = Con.; E, F = Cu.
14S-63	14S-6	6		6	*	A, C = Al.; B, D = Ch.; E = Ir.; F = Con.
14S-64	14S-2	4		4	*	A, C = Con.; B, D = Cu.
14S-65	14S-6	6		6	*	A, C, E = Cu.; B, D, F = Con.
14S-67	14S-6	6		6	*	A = Al.; B = Ch.; Bal = Cu.
14S-68	14S-2	4		4	45°	A = Ch.; B = Con.; C, D = Cu.
14S-69	14S-7	3		3	*	A = Con.; B = Ch.; C = Cu.
14S-70	14S-2	4		4	*	A, D = Ch.; B, C = Al.
14S-71	14S-2	4		4	*	A, B, D = Cu.; C = Con.
14S-72	14S-9	2		2	*	A = Con.; B = Cu.
14S-73	14S-2	4		4	*	A, B = Cu.; C = Al.; D = Ch.

†Insert arrangements including the letter "S" are available in QWL Series Connectors only.\*No rotation required.

# QWL

## thermocouple arrangements (Cont'd.)

Shell Size and Arrg.†	Similar To MS Arrg.	Total Con-tacts	Contact Size		Pin Insert Rotation C/W	Contact Material
			12	16		
14S-74	14S-2	4		4	*	A, B = Ch.; C, D = Al.
14S-75	14S-2	4		4	*	A, B = Cu.; C, D = Con.
14S-76	14S-2	4		4	*	A, C = Al.; B, D = Ch.
14S-77	14S-2	4		4	*	A, D = Al.; B, C = Ch.
14S-78	14S-9	2		2	*	A = Ch.; B = Al.
14S-79	14S-5	5		5	*	A, B, E = Cu.; C = Al.; D = Ch.
14S-80	14S-9	2		2	*	A = Cu.; B = Con.
14S-81	14S-9	2		2	*	A = Al.; B = Cu.
14S-82	14S-2	4		4	*	A = Ir.; B = Con.; C = Ch.; D = Al.
14S-83	14S-6	6		6	*	A, C = Ir.; B, D = Con.; E, F = Cu.
14S-84	14S-6	6		6	*	A, B = Al.; Bal = Cu.
14S-85	14S-7	3		3	*	A = Ch.; B = Al.; C = Cu.
14S-86	14S-6	6		6	*	A, F = Ir.; B, E = Con.; C, D = Cu.
14S-87	14S-6	6		6	*	A, B, C, D = Ir.; E, F = Con.
14S-88	14S-9	2		2	90°	A = Ch.; B = Con.
14S-89	14S-7	3		3	*	A = Ir.; B = Cu., C = Con.
14S-90	14S-6	6		6	*	A = Al.; C = Ch.; Bal. = Cu.
14S-91	14S-2	4		4	*	A = Al.; B = Ch.; Bal. = Cu.
14S-93	14S-6	6		6	*	A, B, F = Al.; D, C, E = Ch.
14-59	14-53	6		6	*	A = Al.; B = Ch.; C = Ir.; D = Con.; E, F = Cu.
16S-52	16S-4	2		2	*	A = Ch.; B = Al.
16S-54	16S-1	7		7	*	A = Al.; B = Ch.; Bal. = Cu.
16S-55	16S-1	7		7	*	A = Con.; Bal. = Cu.
16S-56	16S-1	7		7	*	A = Al.; D = Ch.; Bal. = Cu.
16S-57	16S-1	7		7	*	A, B = Al.; C, D = Ch.; Bal. = Cu.
16S-58	16S-1	7		7	*	A, G = Al.; Bal. = Ch.
16S-59	16S-1	7		7	*	A, C = Ir.; B, D = Con.; Bal. = Cu.
16S-60	16S-1	7		7	*	A = Ir.; B = Con.; Bal. = Cu.
16S-61	16S-1	7		7	*	G = Al.; Bal. = Ch.
16-52	16-11	2	2		90°	A = Al.; B = Ch.
16-53	16-9	4	2	2	70°	A = Al.; C = Ch.; B, D = Cu.
16-55	16-10	3	3		45°	A = Al.; B = Ch.; C = Cu.
16-56	16-13	2	2		90°	A = Con.; B = Cu.
16-57	16-10	3	3		*	A = Al.; B = Cu.; C = Ch.
16-58	16-10	3	3		*	A = Con.; B, C = Cu.
16-60	16-13	2	2		*	A = Al.; B = Ch.
16-62	16-11	2	2		*	A = Con.; B = Cu.
16-67	16-11	2	2		*	A = Al.; B = Ch.;
16-68	16-9	4	2	2	*	A, B, C = Ch.; D = Al.
18-51	18-12	6		6	*	A = Ir.; B, E = Con.; D = Cu.; C, F = Dummy
18-52	18-11	5	5		*	A = Ir.; B = Con.; C = Ch.; D = Al.; E = Dummy
18-53	18-12	6		6	*	A, D = Ir.; B, E = Con.; C, F = Dummy
18-54	18-15	4	4		*	A, C = Al.; B, D = Ch.
18-56	18-1	10		10	45°	A, C, E, G, I = Ir.; B, D, F, H, J = Con.
18-57	18-12	6		6	45°	A, C, E = Al.; B, D, F = Ch.
18-59	18-12	6		6	45°	A, C = Ir.; B, E, F = Con.; D = Cu.

†Insert arrangements including the letter "S" are available in QWL Series Connectors only.

\*No rotation required.

# QWL

## thermocouple arrangements (Cont'd.)

Shell Size and Arrg.†	Similar To MS Arrg.	Total Con-tacts	Contact Size		Pin Insert Rotation C/W	Contact Material
			12	16		
18-60	18-11	5	5		45°	A, D = Al.; B, C = Ch.; E = Al.
18-61	18-12	6		6	*	A, C = Ir.; B, D = Con.; E = Ch.; F = Al.
18-62	18-12	6		6	*	A, B, C = Ir.; D, E, F = Con.
18-63	18-15	4	4		*	A, C = Con.; B, D = Cu.
18-65	18-12	6		6	*	A = Ir.; B = Con.; Bal. = Cu.
18-66	18-1	10		10	*	A, C, E, G, I = Cu.; B, D, F, H, J = Con.
18-67	18-12	6		6	*	A, C, E = Cu.; B, D, F = Con.
18-68	18-11	5	5		*	A, D = Al.; B, C = Ch.; E = Cu.
18-69	18-1	10		10	*	A = Al.; B = Ch.; Bal. = Cu.
18-70	18-11	5	5		*	A = Ir.; B = Con.; C = Ch.; D = Al.; E = Cu.
18-71	18-15	4	4		*	A = Con.; Bal. = Cu.
18-72	18-15	4	4		*	D = Con.; Bal. = Cu.
18-73	18-9	7	2	5	*	A = Al.; D = Ch.; Bal. = Cu.
18-74	18-12	6		6	*	A = Ch.; B = Al., D = Ir.; E = Cu.; C, F = Con.
18-76	18-1	10		10	*	A, C, E, G, I = Al.; B, D, F, H, J = Ch.
18-77	18-1	10		10	*	A, C, E, G = Al.; B, D, F, H = Ch.; Bal. = Cu.
18-78	18-1	10		10	*	A = Al.; B = Ch.; D, F, H, J = Con.; Bal. = Cu.
18-79	18-12	6		6	*	A, F = Ir.; B, E = Con.; C, D = Cu.
18-80	18-15	4	4		*	A, C = Cu.; B, D = Con.
18-81	18-1	10		10	*	E, G = Con.; Bal. = Cu.
18-82	18-1	10		10	*	E, G = Con.; F, H = Ir.; Bal. = Cu.
20-52	20-4	4	4		315°	A = Ir.; B = Con.; C = Ch.; D = Al.
20-56	20-7	8		8	45°	A, B, G, H = Ir.; C, D, E, F = Con.
20-60	20-7	8		8	45°	D = Ch.; E = Al.; Bal. = Cu.
20-61	20-29	17		17	45°	A, B, M = Cu.; Bal. = Con.
20-62	20-15	7	7		80°	A, C, E = Al.; B, D, F = Ch.; G = Cu.
20-64	20-27	14		14	*	A = Al.; C = Ch.; Bal. = Cu.
20-65	20-27	14		14	*	A, B, C, D, E, F, G = Ir.; H, I, J, K, L, M, N = Con.
20-67	20-16	9	2	7	*	H = Al.; I = Ch.; Bal. = Cu.
20-68	20-7	8		8	*	A, B, G, H = Con.; C, D, E, F = Cu.
20-69	20-27	14		14	*	A, B, C, D, E, F, G = Cu.; H, I, J, K, L, M, N = Con.
20-70	20-29	17		17	*	A, C, E, G, J, L, N, R, T = Ir.; B, D, F, H, K, M, P, S = Con.
20-71	20-29	17		17	*	S = Al.; R = Ch.; Bal. = Cu.
20-74	20-29	17		17	*	A, C, E, G, J, L, N, R = Ir.; B, D, F, H, K, M, P, S = Con.; T = Cu.
20-75	20-15	7	7		*	G = Al.; Bal = Ch.
20-77	20-16	9	2	7	*	A = Con.; Bal. = Std.
20-80	20-27	14		14	*	A, C, E, G, I, K, M = Cu.; B, D, F, H, J, L, N = Con.
20-81	20-27	14		14	*	A, C, E, G, I, K, M = Ch.; B, D, F, H, J, L, N = Al.
20-82	20-29	17		17	*	A, C, E, G, J, L, N, R = Al.; B, D, F, H, K, M, P, S = Ch.; T = Cu.
20-85	20-33	11		11	*	K, L = Al.; Bal. = Ch.
20-87	20-29	17		17	*	A, C, E, G, J, L, N, R = Con.; Bal. = Cu.
20-88	20-27	14		14	*	A, C, E = Al.; B, D, F = Ch.; G, H, K, N = Con.; Bal. = Cu.
20-89	20-27	14		14	*	B, D, F, H, J, L = Al.; A, C, E, G, I, K = Ch.; M, N = Cu.
20-90	20-27	14		14	*	C, G, I = Ch.; K, L, M = Al.; Bal. = Cu.
20-91	20-27	14		14	*	I = Ch.; K = Al.; Bal. = Cu.

\*No rotation required.

# QWL

## thermocouple arrangements (Cont'd.)

Shell Size and Arrg.	Similar To MS Arrg.	Total Con-tacts	Contact Size		Pin Insert Rotation C/W	Contact Material
			12	16		
20-92	20-7	8		8	*	A = Al.; H = Cu.; Bal. = Ch.
20-93	20-27	14		14	*	A = Ch.; B = Al.; Bal. = Cu.
20-94	20-15	7	7		*	A, C, E = Al.; B, D, F = Ch.; G = Cu.
20-99	20-33	11		11	*	A = Al.; Bal. = Ch.
22-57	22-14	19		19	45°	A, C, E, G, J, L, N, R = Ir.; B, D, F, H, K, M, P, S = Con.; T, U, V = Cu.
22-60	22-14	19		19	45°	U = Al.; N = Ch.; Bal. = Cu.
22-62	22-23	8	8		60°	A, B, F, G = Al.; C, D, E, H = Ch.
22-68	22-19	14		14	45°	A, C, E, G, J, L, M = Ir.; B, D, F, H, K, P, N = Con.
22-69	22-19	14		14	45°	A, C, E, G, J, L, M = Cu.; B, D, F, H, K, P, N = Con.
22-71	22-14	19		19	*	V = Al., U = Ch.; Bal. = Cu.
22-72	22-5	6	2	4	*	B = Al.; E = Ch.; Bal. = Cu.
22-73	22-5	6	2	4	*	E = Al.; B = Ch.; Bal. = Cu.
22-74	22-23	8	8		*	A, C, E, G = Ir.; B, D, F, H = Con.
22-75	22-23	8	8		*	A = Al.; B, D, G, H = Cu.; C = Ch.; E = Ir.; F = Con.
22-76		21		21	*	W = Con.; Bal. = Cu.
22-77	22-19	14		14	*	B, D, F, H, J, K, M, P = Cu.; A, E, L = Ir.; C, G, N = Con.
22-78	22-14	19		19	*	A, C, E, G, H, K, M, P, R, T = Con.; Bal. = Cu.
22-79	22-10	4		4	*	A, C = Con.; B, D = Cu.
22-82	22-14	19		19	*	A, C, E, G, J, L, N, R, T = Ir.; B, D, F, H, K, M, P, S, U = Con.; V = Cu.
22-83	22-18	8		8	*	A, C, E, G = Al.; B, D, F, H = Ch.
22-84	22-14	19		19	*	A, C, S = Ch.; B, D, T = Al.; Bal. = Cu.
22-85	22-19	14		14	*	A, C, E, G, J, L, N = Al.; B, D, F, H, K, M, P = Ch.
22-89	22-28	7	7		*	A, C, E = Ir.; B, D, F = Con.; G = Cu.
24-56	24-20	11	2	9	45°	E = Al.; F = Ch.; Bal. = Cu.
24-57	24-28	24		24	45°	A, C, J, V, Y, W, K, E, H, U, S, M = Ch.; Bal. = Al.
24-62	24-28	24		24	*	A, C, E, G = Ir.; B, D, F, H = Con.; R, T = Ch.; S, U = Al.; Bal. = Cu.
24-63	24-28	24		24	*	A, C, E, G, J, L, K, N, S, U, W, Y = Cu.; B, D, F, H, Q, R, M, P, T, V, X, Z = Con.
24-64	24-5	16		16	*	A, B, C, D, E, F, G, H = Ir.; J, K, L, M, N, P, R, S = Con.
24-68	24-28	24		24	*	D = Con.; Bal. = Cu.
24-81	24-7	16	2	14	*	A, C, E, G, I, K, M, N, P = Cu.; B, D, F, H, J, L, O = Con.
24-88	24-28	24		24	*	A, B, C, D, E, F, G, H, J, K, L, M = Con.; Bal. = Ir.
24-91	24-5	16		16	*	A, B, C, D, E, F, G, H = Al.; J, K, L, M, N, P, R, S = Ch.
28-53	28-11	22	4	18	45°	J, L = Al.; K, M = Ch.; Bal. = Cu.
28-58	28-20	14	10	4	45°	A, C, E, G, K, M = Al.; B, D, F, H, L, N = Ch.; J, P = Cu.
28-61	28-21	37		37	45°	A, C, J, Z, m, r, n, a, K, F, H, X, k, h, T, M, N, d = Ir.; Bal. = Con.
28-63	28-20	14	10	4	45°	A, C, E, G, J = Al.; B, D, F, H, P = Ch.; Bal. = Cu.
28-64	28-15	35		35	*	A, d = Al.; B, j = Ch.; C, D, E, F, G, N, P, R, S, H, J, K, L, M, W, X, Y, Z = Con.; Bal. = Cu.
28-65	28-12	26		26	*	A, C, E, G, J, L, N, R, T, V = Ir.; X, Z = Al.; B, D, F, H, K, M, P, S, U, W = Con.; Y, a = Ch.; b, d = Cu.
28-67	28-16	20		20	*	U = Con.; Bal. = Cu.
28-68	28-15	35		35	45°	T = Al.; U = Ch.; Bal. = Cu.
28-69	28-11	22	4	18	*	G = Al.; R = Ch.; Bal. = Cu.
28-70	28-11	22	4	18	*	A = Al.; B = Ch.; Bal. = Cu.
28-77	28-11	22	4	18	*	J = Con.; Bal. = Cu.



# QWL

## thermocouple arrangements (Cont'd.)

Shell Size and Arrg.	Similar To MS Arrg.	Total Con-acts	Contact Size		Pin Insert Rotation C/W	Contact Material
			12	16		
28-81	28-21	37		37	*	A, D, S, Z, n, s = Ir.; B, J, K, f, g, r, = Con.; G, L, P, b, e, j = Al.; F, H, T, X, h, k = Ch.; Bal. = Cu.
28-85	28-11	22	4	18	45°	K, M = Al.; J, L = Ch.; Bal. = Cu.
28-91	28-9	12	6	6	*	M = Ir.; L = Con.; Bal. = Cu.
28-94	28-12	26		26	*	B, D, F, H, K, M, P, S, U, W, Y, a, d = Al.; Bal. = Ch.
28-98	28-21	37		37	*	M = Al.; F = Ch.; Bal. = Cu.
28-99	28-12	26		26	*	B, D, F, H, K, M, P, S, U, W, Y, a = Con.; Bal. = Cu.
28-AC	28-16	20		20	*	A, C, E, G, J, L = Ir.; B, D, F, N, K, M = Con.; Bal. = Cu.
28-AD	28-21	37		37	45°	A, C, F, H, J, K, M, N, T, X, Z, a, d, h, k, m, n, r = Cu.; Bal. = Con.
28-AE	28-21	37		37	*	A, C, E, G, J, L, N, R, T, V, X, a, c, e, g, j, m, p, s = Cu.; Bal. = Con.
28-AF	28-18	12		12	*	A, C, E, G, J, L = Ch.; Bal. = Al.
28-AG	28-12	26		26	*	A, C, E, G, J, L, N, R = Al.; B, D, F, H, K, M, P, S = Ch.; Bal. = Cu.
28-AK	28-21	37		37	*	A, B, C, D, J, K, L, M, N, P, X, a, b, c, d, e, m, p = Ch.; n = Cu.; Bal. = Al.
32-51	32-8	30	6	24	90°	M = Ch.; N = Al.; Bal. = Cu.
32-55	32-8	30	6	24	125°	M, N, = Ch.; O, P = Al.; Bal. = Cu.
32-91	32-64	54		54	*	A, C, E, G, J, L, N, P, S, U, W, Y, a, c, e, g, j, m = Ir.; B, D, F, H, K, M, O, R, T, V, X, Z, b, d, f, h, k, n = Con.; Bal. = Cu.
36-53	36-7	47	7	40	45°	u, v, w = Al.; x, y, z = Ch.; Bal. = Cu.
36-56	36-10	48		48	*	A, C, E, G, L, J, H, P, R, T, V, X, Z, b, d, f, h, k, q, n, m, u, w, y = Con.; Bal. = Cu.
36-57	36-8	47	1	46	*	W = Al.; f = Ch.; Bal. = Cu.
36-58	36-15	35		35	*	H = Al.; G = Ch.; Bal. = Cu.
36-61	36-15	35		35	*	A, C, E, J, K, L, M, N, P, R, T, V, f, X, Y, h, j, c = Con.; Bal. = Cu.
36-62	36-10	48		48	*	A, C, E = Al.; B, D, F = Ch.; Bal. = Cu.
36-82	36-52††	52		52	*	v, g = Ir.; p, y, c = Con.; x = Ch.; Bal. = Cu.
36-86	36-10	48		48	*	A, C, E, G, J, L, N, P, R, T, V, X = Al.; B, D, F, H, K, M, O, Q, S, U, W, Y = Ch.; z, b, d, f, h, k, n, q, s, u, w, y = Con.; a, c, e, g, j, m, p, r, t, v, x, z = Cu.
36-88	36-52	52		52	*	A, C, E, H, K, M, P, S, U, W, Y, a, c, f, h, j, m, p, r, t, v, x, z, AB, AD, AF = Cu.; Bal. = Con.
40-58	40-56††	85		85	*	A, C, E, H, K, M, P, S, U, W, Y, a, c, f, h, j, m, p, r, t, v, x, z, AB, AD, AF, AJ, AL, AN, AP, AS, AU, AW, AY, BA, BC, BE, BH, BK, BM, BP, BS, BU = Ir.; Bal. = Con.
40-59	40-56††	85		85	*	B = Ch.; C = Con.; Bal. = Cu.
40-77	40-53††	60		60	*	55, 60 = Ir.; 57, 58, 59 = Con.; 56 = Ch.; Bal. = Cu.
40-78	40-53††	60		60	*	50, 51 = Ir.; 27, 28, 29, 31, 32, 34, 36, 37, = Con.; 25, 39, 40, 41 = Al.; 43, 44, 45, 46, 47, 48, 49, 52, 53, 54 = Ch.; Bal. = Cu.
40-88	40-53	60		60	*	1, 3, 5, 7, 9, 11, 13, 15, 17, 19, 21, 23, 25, 27, 29, 31, 33, 35, 37, 39, 41, 43, 45, 47, 49, 51, 53, 55, 57, 59 = Con.; Bal. = Cu.
40-AA	40-56	85		85	*	A, C, E, H, K, M, P, S, U, W, Y, a, c, f, h, j, m, p, r, t, v, x, z, AB, AD, AF, AJ, AL, AN, AR, AT = Cu.; B, D, F, J, L, N, R, T, V, X, Z, b, d, g, i, k, n, q, s, u, w, y, AA, AC, AE, AH, AK, AM, AP, AS = Con.; AU, AW, AY, BA, BC, BE, BH, BK, BM, BP, BS, BU = Ch.; AV, AX, AZ, BB, BD, BF, BJ, BL, BN, BR, BT, BV = Al.
44-57	44-52	104		104	*	A, C, E, G, J, L, etc. = Cu.; B, D, F, H, K, M, etc. = Con.
44-59	44-52	104		104	*	34 = Con.; 70 = Cu.
44-60	44-52	104		104	*	A, C, E, etc. = Ch., (52); B, D, F, etc. = Al. (52)
44-62	44-52	104		104	*	BY, BZ, CA, CB, CC, CD, CE, CR = Al.; CH, CJ, CK, CL, CM, CN, CP CS = Ch.; Bal. = Cu.

††Amphenol® arrangement\*No rotation required.

# Other Heavy Duty Cylindrical Connectors Offered by Amphenol

## Class “L” MIL-C-22992, QWLD and Star-Line

Amphenol meets the demands for heavy duty connectors by providing three additional cylindrical connector series, each with unique design characteristics for reliable operation in specific industrial environments.

**Class “L”, MIL-C-22992** – for the heaviest electrical loads; for military and industrial applications.

- MIL-C-22992 qualification.
- Current range from 40 to 200 amperes.
- Direct current or single/three phase, 60/400 Hertz alternating current.
- Rugged shells are resistant to vibration, high impact, shock and corrosion
- Double stub threads per MIL-STD-1373 for fast coupling and easy cleaning.
- Five key polarization system assures that circuits with incompatible power characteristics (voltage, phase and frequency) are not mated.
- Crimp termination. Contacts can be soldered.
- Automatic grounding for safety.
- Unique arc quenching capability provides a positive safety feature if connectors are inadvertently disconnected under load.
- 4 shell styles with 7 insert patterns that facilitate large conductors.
- Grommets and seals provide waterproofing.



**Heavy Duty Class “L” Connectors**

**QWLD** – for most power and control circuits

- Military (MIL-C-22992) qualified connectors and industrial equivalents available.
- Increased shell size for greater durability than similar standard connectors.
- Crimp or solder termination.
- Double stub threaded per MIL-STD-1373.
- 7 shell styles with over 300 insert patterns (MIL-C-5015 inserts plus specials)
- Class C is pressurized; Class R is environmental.

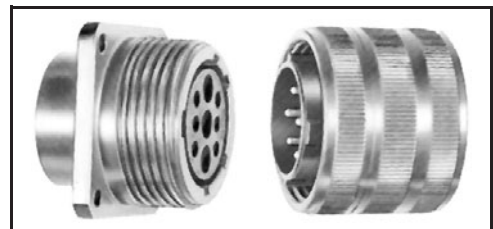

**QWLD Series**

**Star-line® Series** – heavy duty environmentally sealed plugs and receptacles that are used in all types of industrial and aerospace applications.

- Equals or exceeds MIL-C-5015 E and R specifications.
- UL listed and CSA listed circuit breaking capability.
- Up to high amperage of 1135 amps at 1000VAC or DC rating available.
- Solder, crimp and pressure terminals. Circuit breaking power and control types.
- Double lead Acme threads provide complete coupling in one turn of the coupling nut, and do not clog under adverse weather conditions.
- IP67 rating for environmental sealing.
- Hard anodic coating provides dielectric strength with heat and corrosion resistance.



**Star-Line Series**

**Star-line EX® Series** – Hybrid form of the Star-Line series with higher temperature ranges. Cenelec Certified for use in Zone 1-IIc hazardous environments. EX Certificate #03ATEX 1101X.

## X-ON Electronics

Largest Supplier of Electrical and Electronic Components

*Click to view similar products for [Circular MIL Spec Contacts](#) category:*

*Click to view products by [Amphenol](#) manufacturer:*

Other Similar products are found below :

[006-1189-20](#) [71-VEAM](#) [809-023](#) [809-111](#) [811393-000](#) [850-014](#) [97-45-1418P-5\(920\)](#) [97-45-1418S-4](#) [D-602-0106CS076](#) [AIC12-14P](#)  
[AIC16-16PG](#) [AIC8-12P](#) [AIC8-8SG](#) [AIC8-8SRAD](#) [1495044-1](#) [BACC47CP2T](#) [BACC47CP3S](#) [BACC47DP4](#) [BACC47GC1A](#) [BACC47GN1](#)  
[16968/2C](#) [173-900245-91](#) [241611N001](#) [2560-220-2031](#) [27915-38T9](#) [27964-38T112](#) [2M809-118](#) [97-67-36-20](#) [AIC12-16P](#) [AIC16-14SG](#)  
[AIC16-18PG](#) [AIC16-18S](#) [AIC16-20PG](#) [AIC4-4PG](#) [CE102S-18](#) [M39029/30-221](#) [M39029/77-430](#) [416-2020-088I](#) [MDM-21SH003B-F222](#) [48-](#)  
[100-5014P-02](#) [BA-4020-50LD](#) [BA-4120-50LD](#) [BACC47CN2](#) [BACC47GC3A](#) [BACC47GD3A](#) [BACC47GM1](#) [52G137 REV A](#) [CB2-18-21PS](#)  
[D-602-1116CS2727](#) [D-602-1117CS2727](#)