

HOUSING

FIRST CIRCUIT INDICATOR

FCI PART NUMBER AND DATE CODE

HOLD DOWN SEE NOTES 8

SIGNAL CONTACT POWER CONTACTS

25Sx10P CONFIGURATION SHOWN HOLD DOWN TYPE

SCREW MOUNT SEE NOTES 9



25Sx10P CONFIGURATION SHOWN SCREW MOUNT TYPE

NOTES:

- HOUSING MATERIAL: GF LCP, COLOR: BLACK, UL 94 V-0 RATED
SIGNAL CONTACT MATERIAL: PHOSPHOR BRONZE
SIGNAL PIN OVERMOLD MATERIAL: GF POLYESTER
POWER CONTACT MATERIAL: COPPER ALLOY
- PLATING ON SIGNAL CONTACTS: 1.27µm MIN Ni UNDERPLATING ALL OVER WITH 0.76µm MIN GXT IN CONTACT MATING AREA, AND 0.5µm MIN MATTE TIN ON TAIL AREA.

PLATING ON POWER CONTACTS: 1.27µm MIN Ni UNDERPLATING ALL OVER WITH 0.76µm MIN GXT IN CONTACT MATING AREA, AND 0.5µm MIN MATTE TIN ON TAIL AREA.

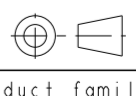
PLATING ON HOLD DOWN IF APPLICABLE: 1.27µm MIN Ni, UNDERPLATING ALL OVER WITH 0.76µm MIN MATTE TIN OVER.
- LUBRICATION: LUBRICATE ON CONTACT AREA.
- RECOMMENDED PCB THICKNESS IS:
FOR PRESS FIT APPLICATION: 1.4mm MIN
FOR SOLDER APPLICATION: 1.40mm THROUGH 2.62mm.
- FOR SCREW MOUNT APPLICATIONS, A #4-40 UNC PAN SCREW WITH HEX NUT IS RECOMMENDED (SUPPLIED BY CUSTOMER).
- FOR PRESS FIT $\varnothing 0.61 \pm 0.05\text{mm}$, FOR SOLDER $\varnothing 0.90 \pm 0.05\text{mm}$.
- UNPLATED HOLES.
- HOLD DOWN APPLICATION NEEDED.
- SCREW MOUNT APPLICATION NEEDED.
- PRODUCT SPECIFICATION: GS-12-1064
APPLICATION SPECIFICATION: GS-20-0362

spec ref	SEE NOTE 10	dr	Zhang Hong-Tu	2012/08/13	projection	MM	size	A2	scale	1:1
tolerance std	TOLERANCES UNLESS OTHERWISE SPECIFIED	eng	De-Ming Lu	2017/05/09			ecn no	ELX-DG-18076-1		
ISO 406		chr	Fancy Zhang	2017/05/23			rel level	Released		
ISO 1101		appr	Pei-Ming Zheng	2017/05/26			product family	PwrLoPro		
surface	linear		PWR LoPro HEADER ASSEMBLY			cat. no.	10122460			
ISO 1302	0.X		±0.30	RA, PASSIVE GUIDE,S+P			rev	H		
	0.XX		±0.20	Product - Customer Drw			sheet 1 of 10			
	0.XXX	±0.10								
	angular	0°	±2°							

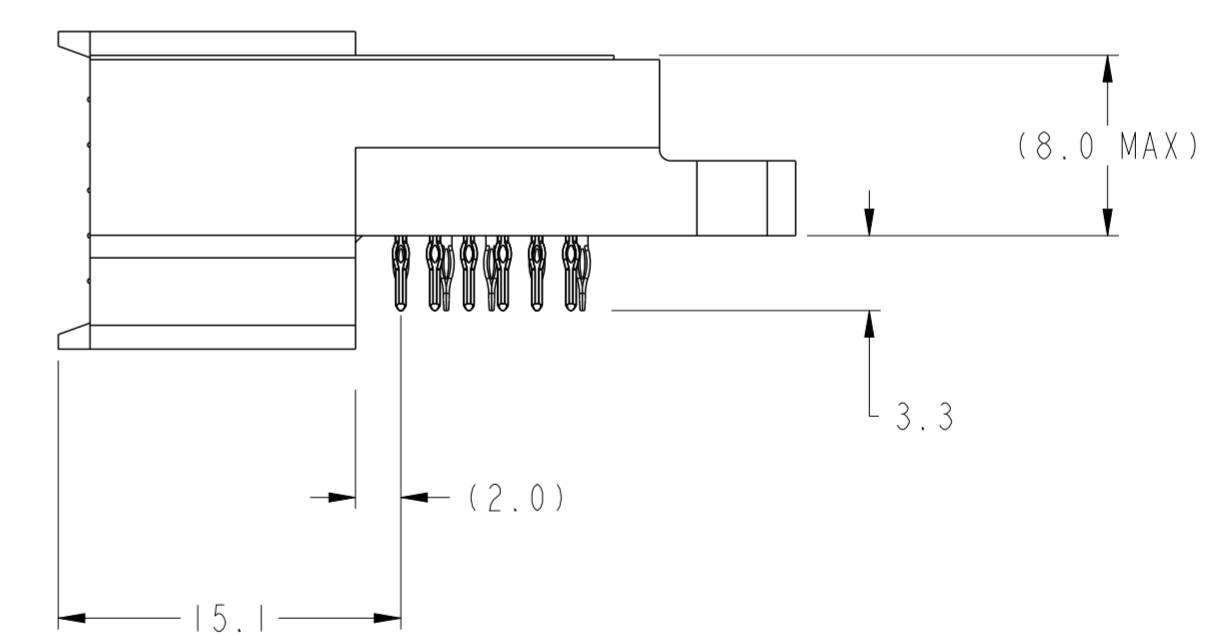
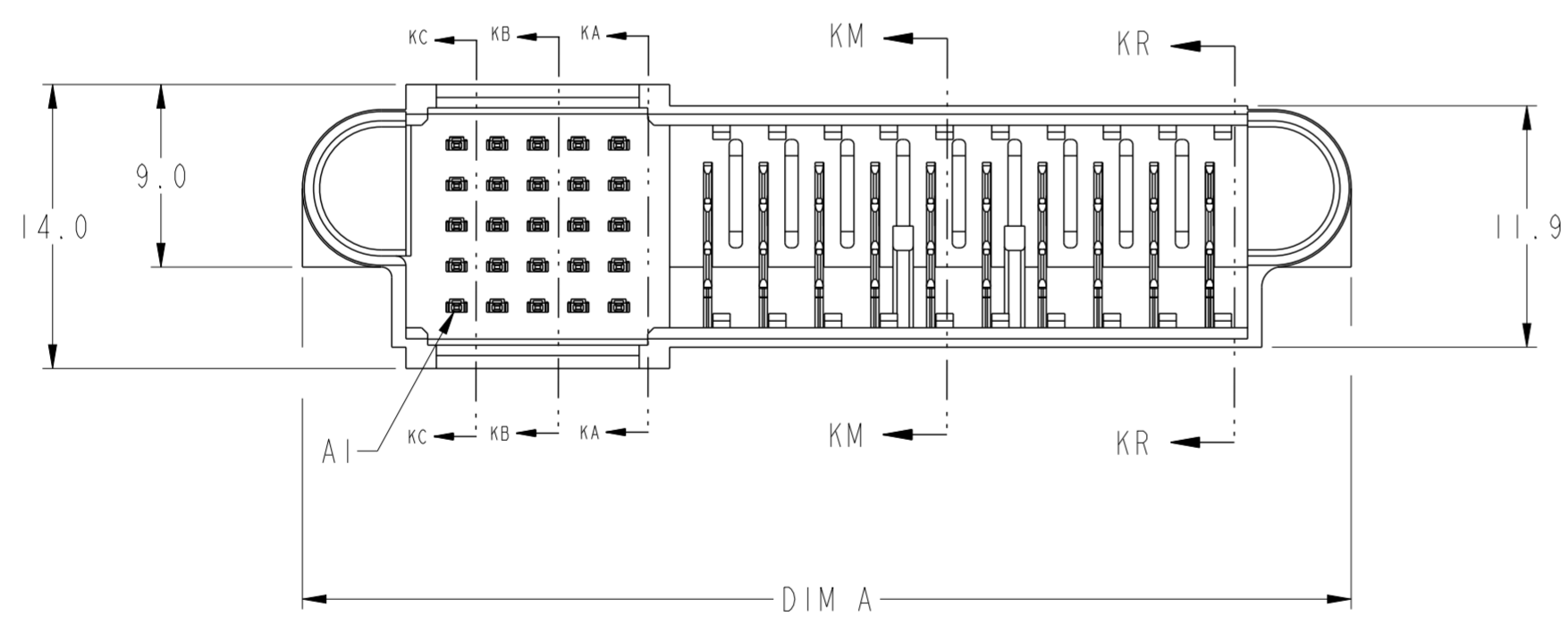
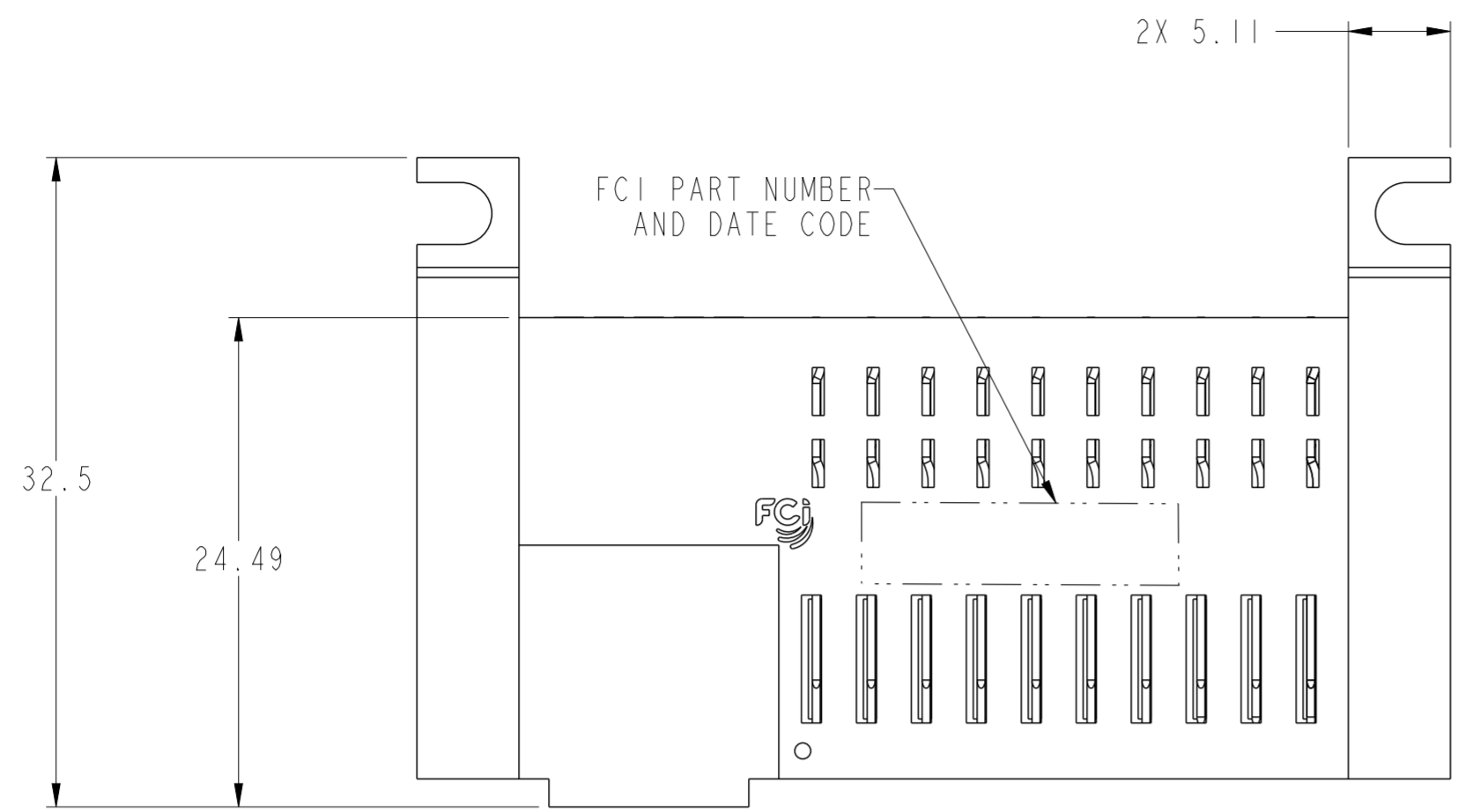

SCREW MOUNT TYPE AS SHOWN

spec ref	SEE NOTE 10	dr	Zhang Hong-Tu	2012/08/13	projection	MM	size	A2	scale	3:1
tolerance std	ISO 406 ISO 1101	eng	De-Ming Lu	2017/05/09			ecn no	ELX-DG-18076-1		
surface	TOLERANCES UNLESS OTHERWISE SPECIFIED linear 0.X ±0.30 0.XX ±0.20 0.XXX ±0.10 angular 0° ±2°	chr	Fancy Zhang	2017/05/23			rel level	Released		
ISO 1302		appr	Pai-Ming Zheng	2017/05/26			product family	PwrLoPro		
		Amphenol FCI			title PWR LoPro HEADER ASSEMBLY RA, PASSIVE GUIDE,S+P		dwg no 10122460	rev H	Product - Customer Drw sheet 2 of 10	

PDS: Rev :H

STATUS:Released

Printed: May 26, 2017

Amphenol FCI

© 2016 AFCI

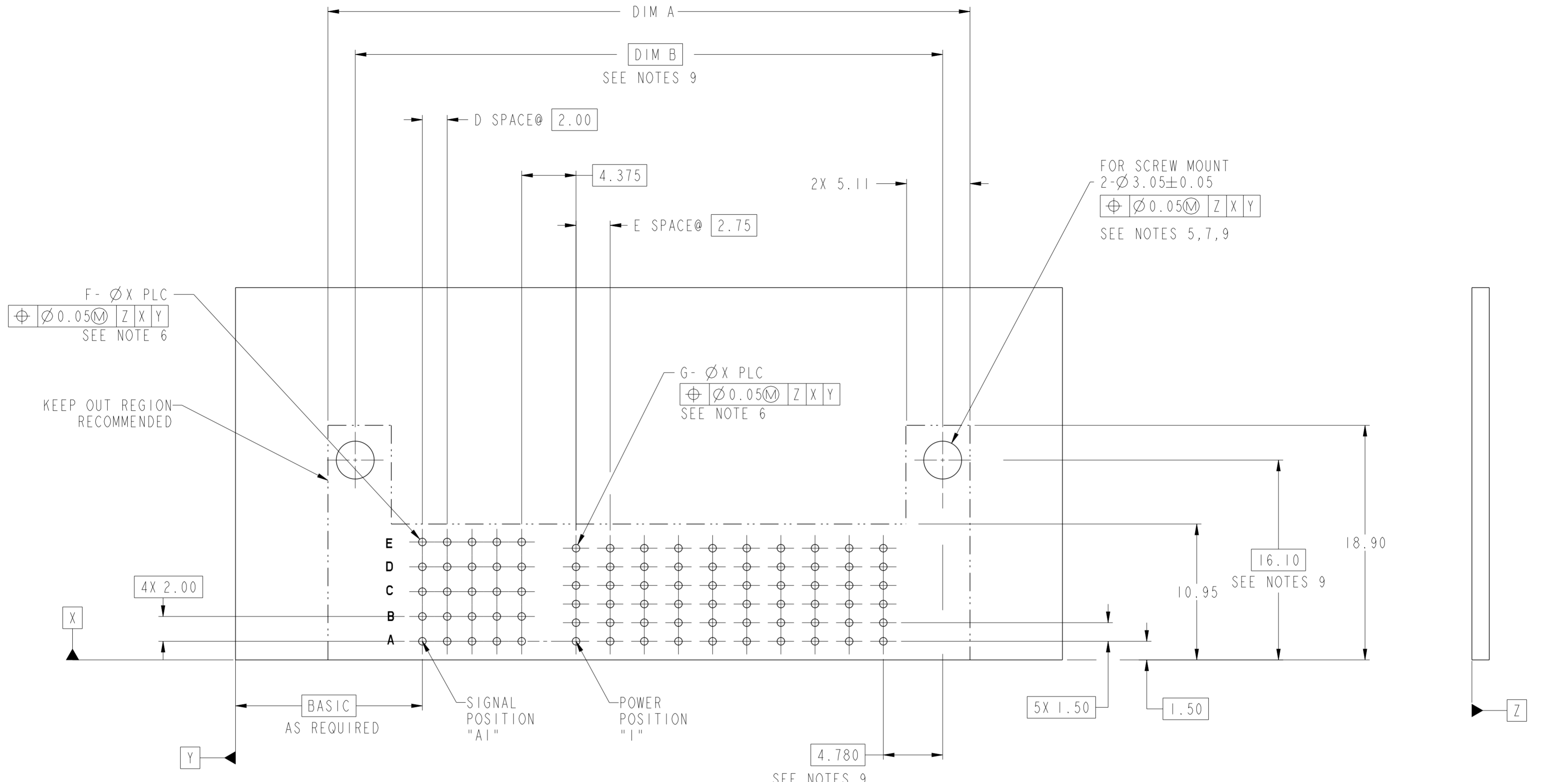

10122460-002LF AS SHOWN
 RECOMMENDED PRINTED CIRCUIT BOARD LAYOUT SEE NOTE 4
 FOR 10122460-XXXLF SCREW MOUNT TYPE
 (AS VIEWED FROM COMPONENT SIDE)

spec ref	SEE NOTE 10	dr	Zhang Hong-Tu	2012/08/13	projection	MM	size	A2	scale	3:1	
tolerance std	ISO 406 ISO 1101	eng	De-Ming Lu	2017/05/09			ecn no	ELX-DG-18076-1	rel level	Released	
surface	linear 0.X ±0.30 0.XX ±0.20 0.XXX ±0.10 angular 0° ±2°	chr	Fancy Zhang	2017/05/23			product family	PwrLoPro		rel level	Released
		appr	Pei-Ming Zheng	2017/05/26			title	PWR LoPro HEADER ASSEMBLY RA, PASSIVE GUIDE,S+P		cat. no.	-

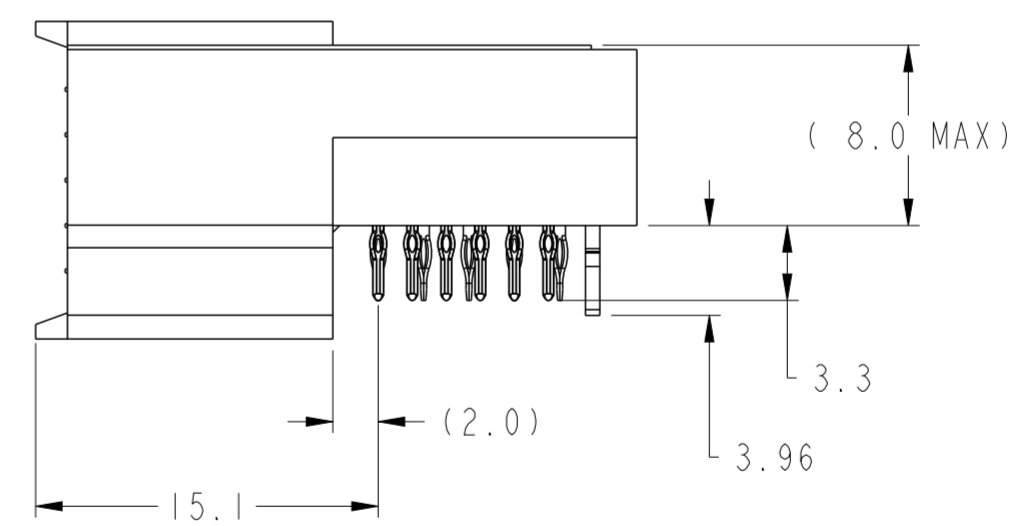
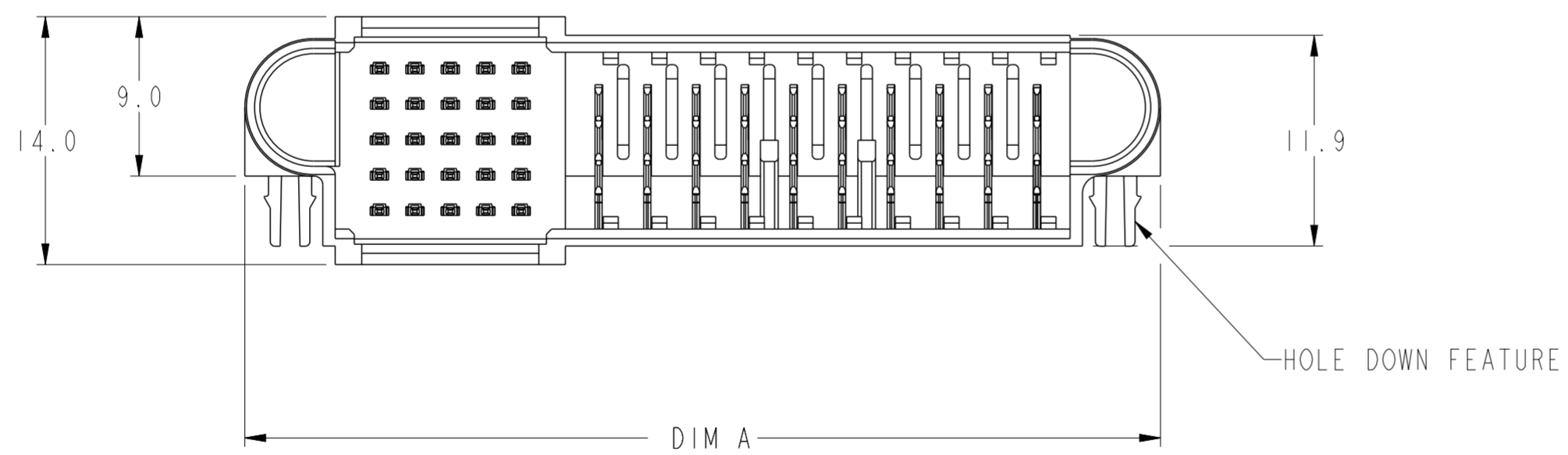
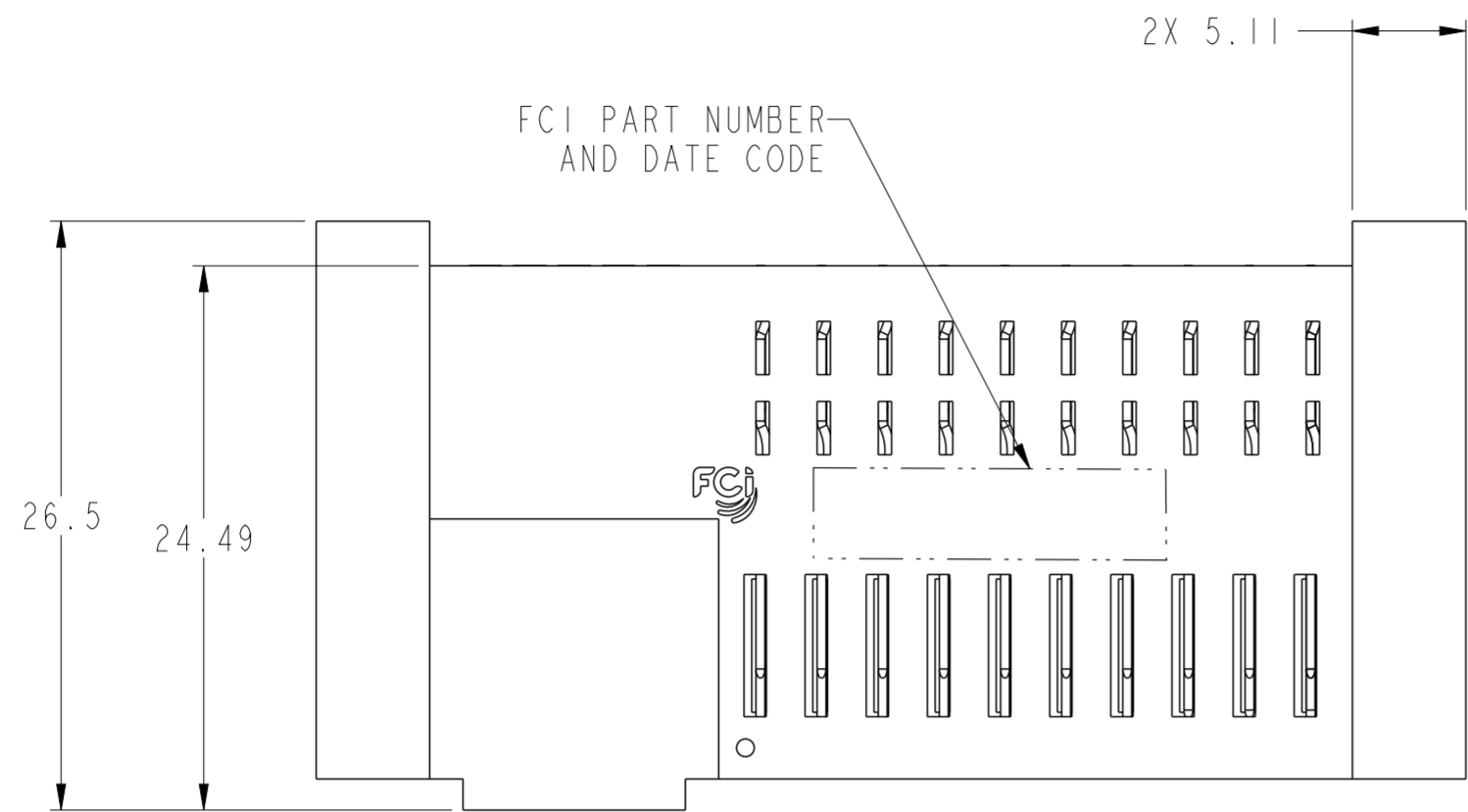

HOLE DOWN TYPE AS SHOWN

spec ref	SEE NOTE 10	dr	Zhang Hong-Tu	2012/08/13	projection	MM	size	A2	scale	3:1
tolerance std	TOLERANCES UNLESS OTHERWISE SPECIFIED	eng	De-Ming Lu	2017/05/09			ecn no	ELX-DG-18076-1		
ISO 406		chr	Fancy Zhang	2017/05/23			rel level	Released		
ISO 1101		appr	Pei-Ming Zheng	2017/05/26	product family	PwrLoPro		rel level	Released	
surface	linear				title	PWR LoPro HEADER ASSEMBLY		dwg no	10122460	
ISO 1302	angular				RA, PASSIVE GUIDE,S+P			rev	H	
					cat. no.			Product - Customer Drw	sheet 4 of 10	

PDS: Rev :H

STATUS:Released

Printed: May 26, 2017

Amphenol
FCi

© 2016 AFci

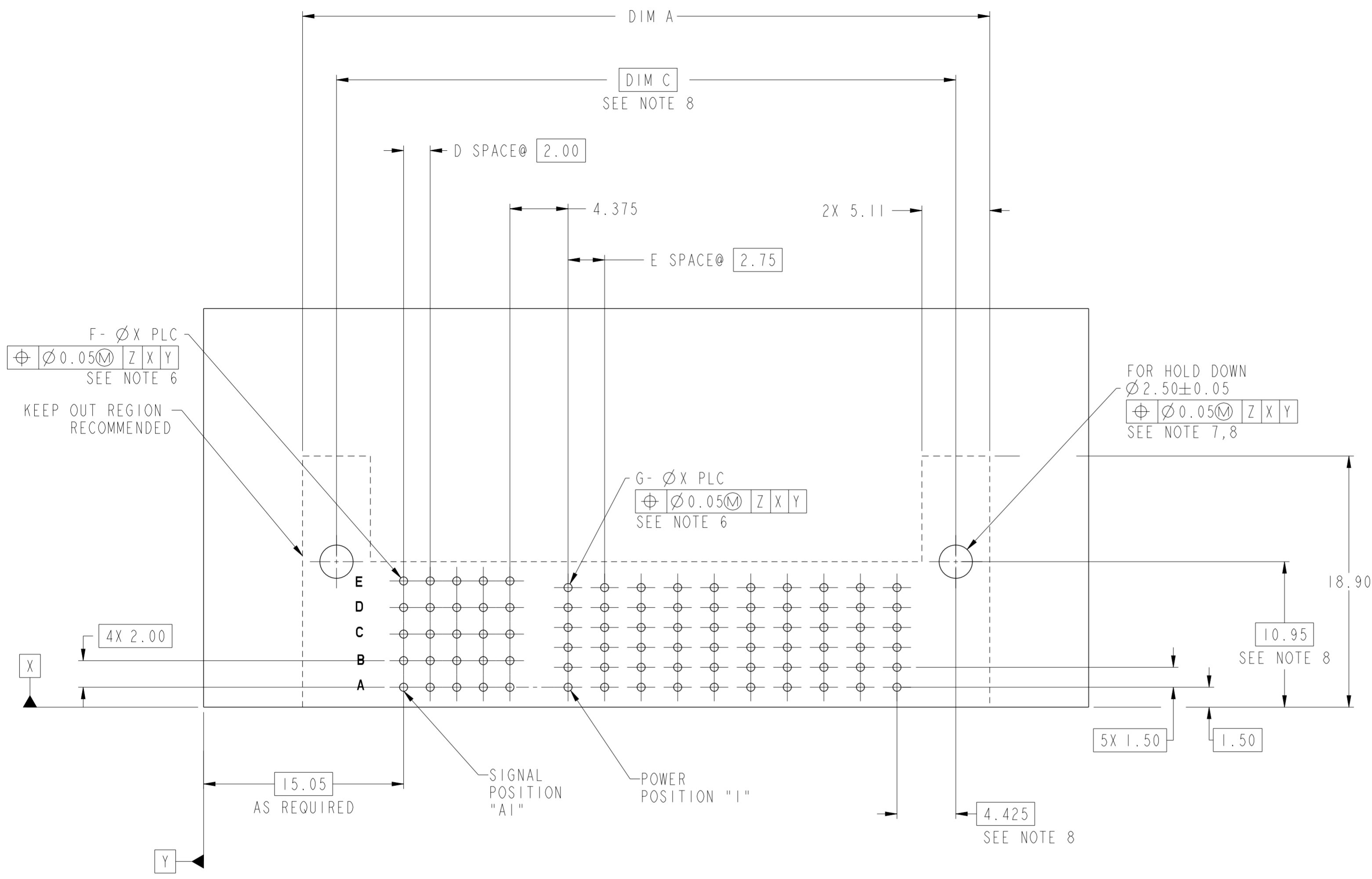

10122460-003LF AS SHOWN
 RECOMMENDED PRINTED CIRCUIT BOARD LAYOUT SEE NOTE 4
 FOR 10122460-XXXLF HOLD DOWN TYPE
 (AS VIEWED FROM COMPONENT SIDE)

spec ref	SEE NOTE 10	dr	Zhang Hong-Tu	2012/08/13	projection	MM	size	A2	scale	4:1
tolerance std	ISO 406 ISO 1101	eng	De-Ming Lu	2017/05/09		MM	ecn no	ELX-DG-18076-1	rel level	Released
TOLERANCES UNLESS OTHERWISE SPECIFIED		chr	Fancy Zhang	2017/05/23						
		appr	Pei-Ming Zheng	2017/05/26						
surface	ISO 1302	linear	0.X	±0.30	product family	PwrLoPro	rel level	Released	title	PWR LoPro HEADER ASSEMBLY
			0.XX	±0.20	RA, PASSIVE GUIDE,S+P	cat. no.			Product - Customer Drw	sheet 5 of 10
		angular	0°	±2°						

PDS: Rev :H

STATUS:Released

Printed: May 26, 2017

PART NUMBER	CONFIGURATION	DIM "A"	DIM "B" FOR SCREW MOUNT	DIM "C" FOR HOLD DOWN	"D" SPACES	"E" SPACES	"F" QTY.	"G" QTY.	MOUNTING FEATURE
10122460-001LF	35S+18P	77.71	-	72.60	6	17	35	108	HOLD DOWN
10122460-003LF	25S+10P	51.71	-	46.6	4	9	25	60	HOLD DOWN
10122460-004LF	25S+8P	46.21	-	41.1	4	7	25	48	HOLD DOWN
10122460-005LF	25S+10P	51.71	-	46.6	4	9	25	60	HOLD DOWN
10122460-006LF	25S+8P	46.21	-	41.1	4	7	25	48	HOLD DOWN
10122460-007LF	25S+10P	51.71	47.31	-	4	9	25	60	SCREW MOUNT
10122460-008LF	15S+2P	25.71	-	15.1	2	1	15	12	HOLD DOWN
10122460-009LF	25S+10P	51.71	-	46.6	4	9	25	60	HOLD DOWN
10122460-010LF	35S+20P	83.21	-	78.1	6	19	35	120	HOLD DOWN
10122460-011LF	25S+02P	29.71	-	24.6	4	1	25	12	HOLD DOWN
10122460-013LF	25S+10P	51.71	47.31	-	4	9	25	60	SCREW MOUNT

Amphenol FCI

© 2016 AFCI

spec ref	SEE NOTE 10	dr	Zhang Hong-Tu	2012/08/13	projection	MM	size	A2	scale	3:1	
tolerance std	TOLERANCES UNLESS OTHERWISE SPECIFIED	eng	De-Ming Lu	2017/05/09		MM	A2	3:1	ecn no	ELX-DG-18076-1	
ISO 406		chr	Fancy Zhang	2017/05/23					rel level	Released	
ISO 1101		appr	Pai-Ming Zheng	2017/05/26					product family	PwrLoPro	
surface	linear	0.X	±0.30	Amphenol FCI	PWR LoPro HEADER ASSEMBLY	RA, PASSIVE GUIDE,S+P	10122460	rev	H		
ISO 1302	0.XX	±0.20	angular							0°	±2°
	0.XXX	±0.10									
cat. no.		-		Product - Customer Drw		sheet 6 of 10					

PDS: Rev :H

STATUS:Released

Printed: May 26, 2017

CUSTOMER LOADING WORKSHEET FOR SIGNAL & POWER SEQUENCING LEVELS

PWR LO PRO - MATING FACE OF HEADER CONNECTOR(4)

E		COLUMNS																																
D																																		
C																																		
B																																		
A																																		
ROWS	MOUNTING FEATURE(3)	1	2	3	4	5	6	7	8	1	2	3	4	5	6	7	8	9	10	11	12	13	14	15	16	17	18	19	20	21	22	23	24	MOUNTING FEATURE(3)
		SIGNAL CONTACTS(2)								POWER CONTACTS(1)																								

- 1). LOAD WITH CHOICE OF 2 POWER CONTACT MATING LEVELS, SEE SECTIONS KM & KR FOR AVAILABLE LEVEL OPTIONS.
- 2). LOAD WITH CHOICE OF 3 SIGNAL CONTACT MATING LEVELS, SEE SECTIONS KA,KB,&KC FOR AVAILABLE LEVEL OPTIONS.
- 3). MOUNTING FEATURE OPTION "X"
 - H : HOLD DOWN TYPE
 - S : SCREW MOUNT TYPE
- 4). CUSTOMER LOADING WORKSHEET SHOWN AT MAXMUM SIZE CONFIGURATION (40Sx24P), SIGNALS AVAILABLE IN 2,3,4 THRU 8 POSITIONS, POWERS AVAILABLE IN 4,6,8 THRU 24 POSITIONS IN EVEN QUANTITIES ONLY.

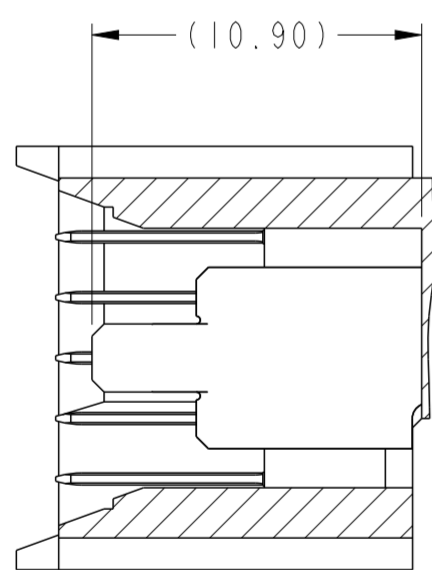

POWER SECTION KM-KM
LEVEL 1:
LONGEST MATING CONTACTS

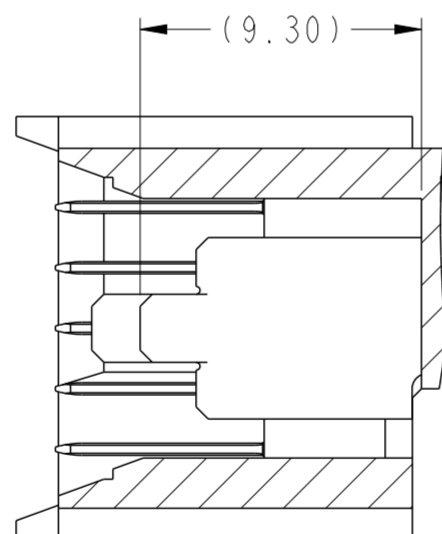

POWER SECTION KR-KR
LEVEL 2:
SHORTEST MATING CONTACTS

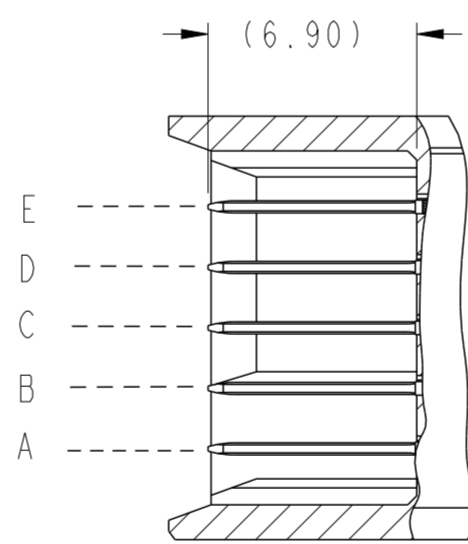

SIGNAL SECTION KA-KA
LEVEL 2:
ALL LONGEST CONTACTS

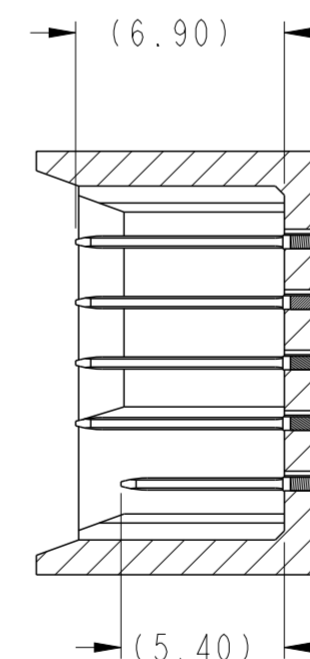

SIGNAL SECTION KB-KB
LEVEL 3222 (MIXED):
ROW "A", SHORTEST CONTACT
ROW "B" THRU "E", LONGEST CONTACTS

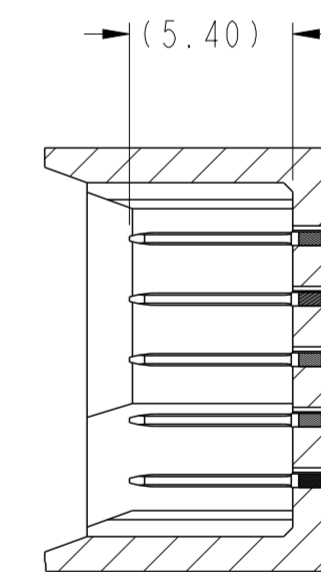

SIGNAL SECTION KC-KC
LEVEL 3:
ALL SHORTEST CONTACTS

Amphenol FCI

© 2016 AFCI

spec ref	SEE NOTE 10	dr	Zhang Hong-Tu	2012/08/13	projection	MM	size	A2	scale	1:1				
tolerance std	ISO 406 ISO 1101	eng	De-Ming Lu	2017/05/09			ecn no	ELX-DG-18076-1	rel level	Released				
surface	linear	0.X	±0.30	Amphenol FCI							PWR LoPro HEADER ASSEMBLY RA, PASSIVE GUIDE,S+P	cat. no.	Product - Customer Drw	sheet 7 of 10
		0.XX	±0.20											
	angular	0°	±2°		dwg no									

PART NUMBER	ROWS	SIGNALS							POWERS																	
		1	2	3	4	5	6	7	1	2	3	4	5	6	7	8	9	10	11	12	13	14	15	16	17	18
10122460-001LF 35S + 18P	E																									
	D																									
	C																									
	B																									
	A																									

PART NUMBER	ROWS	SIGNALS					POWERS										
		1	2	3	4	5	1	2	3	4	5	6	7	8	9	10	
10122460-003LF 25S + 10P	E																
	D																
	C																
	B																
	A																

PART NUMBER	ROWS	SIGNALS					POWERS								
		1	2	3	4	5	1	2	3	4	5	6	7	8	
10122460-004LF 25S + 8P	E														
	D														
	C														
	B														
	A														

PART NUMBER	ROWS	SIGNALS					POWERS										
		1	2	3	4	5	1	2	3	4	5	6	7	8	9	10	
10122460-005LF 25S + 10P	E																
	D																
	C																
	B																
	A																

VIEWED FROM MATING FACE:

Amphenol
FCi

© 2016 AFci

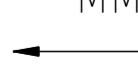
spec ref	SEE NOTE 10	dr	Zhang Hong-Tu	2012/08/13	projection	MM	size	A2	scale	1:1
tolerance std	ISO 406 ISO 1101	eng	De-Ming Lu	2017/05/09			ecn no	ELX-DG-18076-1	rel level	Released
surface	linear	0.X	±0.30							
		0.XX	±0.20							
		0.XXX	±0.10							
	angular	0°	±2°	Amphenol FCi	product family	PwrLoPro	rel level	Released	cat. no.	-
				title	PWR LoPro HEADER ASSEMBLY		dra	10122460	rev	H
					RA, PASSIVE GUIDE,S+P				Product - Customer Drw	sheet 8 of 10

PDS: Rev :H

STATUS:Released

Printed: May 26, 2017

PART NUMBER	ROWS	SIGNALS					POWERS									
		1	2	3	4	5	1	2	3	4	5	6	7	8		
10122460-006LF 25S + 8P	E	H	2	2	32222	2	2	-	-	2	2	2	2	2	-	H
	D															
	C															
	B															
	A															

PART NUMBER	ROWS	SIGNALS					POWERS											
		1	2	3	4	5	1	2	3	4	5	6	7	8	9	10		
10122460-007LF 25S + 10P	E	S	2	2	2	2	3	2	2	2	2	2	2	2	2	2	2	S
	D																	
	C																	
	B																	
	A																	

PART NUMBER	ROWS	SIGNALS			POWERS			
		1	2	3	1	2		
10122460-008LF 15S + 2P	E	H	32222	2	2	-	2	H
	D							
	C							
	B							
	A							

PART NUMBER	ROWS	SIGNALS					POWERS											
		1	2	3	4	5	1	2	3	4	5	6	7	8	9	10		
10122460-009LF 25S + 10P	E	H	2	2	3	2	2	2	2	2	2	2	2	2	2	2	2	H
	D																	
	C																	
	B																	
	A																	

spec ref	SEE NOTE 10	dr	Zhang Hong-Tu	2012/08/13	projection	MM	size	A2	scale	1:1	
tolerance std	TOLERANCES UNLESS OTHERWISE SPECIFIED	eng	De-Ming Lu	2017/05/09		Product family	PwrLoPro	rel level	Released	ecn no	ELX-DG-18076-1
ISO 406		chr	Fancy Zhang	2017/05/23							
ISO 1101		appr	Pei-Ming Zheng	2017/05/26							
surface	linear	0.X	±0.30		title	PWR LoPro HEADER ASSEMBLY	dwg no	10122460	rev	H	
ISO 1302	0.XX	±0.20									
	0.XXX	±0.10									
angular	0°	±2°	cat. no.	-	Product - Customer Drw	sheet 9 of 10					

Amphenol FCI

© 2016 AFCI

PART NUMBER	ROWS	SIGNALS							POWERS																			
		1	2	3	4	5	6	7	1	2	3	4	5	6	7	8	9	10	11	12	13	14	15	16	17	18	19	20
10122460-010LF 35S + 20P	E																											
	D																											
	C																											
	B																											
	A																											

PART NUMBER	ROWS	SIGNALS					POWERS	
		1	2	3	4	5	1	2
10122460-011LF 25S + 02P	E							
	D							
	C							
	B							
	A							

PART NUMBER	ROWS	SIGNALS					POWERS																				
		1	2	3	4	5	1	2	3	4	5	6	7	8	9	10											
10122460-013LF 25S + 10P	E																										
	D																										
	C																										
	B																										
	A																										

CODE	DESCRIPTION
1	FOR LEVEL 1
2	FOR LEVEL 2
32222	FOR LEVEL 32222 (MIXED)
3	FOR LEVEL 3

Amphenol
FCi

© 2016 AFCi

spec ref	SEE NOTE 10	dr	Zhang Hong-Tu	2012/08/13	projection	MM	size	A2	scale	1:1
tolerance std	TOLERANCES UNLESS OTHERWISE SPECIFIED	eng	De-Ming Lu	2017/05/09		←	ecn no	ELX-DG-18076-1	rel level	Released
ISO 406		chr	Fancy Zhang	2017/05/23						
ISO 1101		appr	Pei-Ming Zheng	2017/05/26						
		product family	PwrLoPro							
surface	linear	0.X	±0.30	Amphenol FCi	title	PWR LoPro HEADER ASSEMBLY	dwg no	10122460	rev	H
ISO 1302		0.XX	±0.20							
	angular	0°	±2°							
		0.XXX	±0.10	cat. no.		Product - Customer Drw	sheet 10 of 10			

PDS: Rev :H

STATUS:Released

Printed: May 26, 2017

X-ON Electronics

Largest Supplier of Electrical and Electronic Components

Click to view similar products for [Board to Board & Mezzanine Connectors](#) category:

Click to view products by [Amphenol](#) manufacturer:

Other Similar products are found below :

[10135583-642402LF](#) [89885-310LF](#) [589158040000018](#) [6-1393048-0](#) [68683-613](#) [MDF7-12DP-2.54DSA](#) [MDF7-18P-2.54DSA\(01\)](#) [MDF7-20DP-2.54DSA](#) [MDF7-26D-2.54DSA\(55\)](#) [MDF7-3P-2.54DSA\(01\)](#) [MDF7B-3P-2.54DSA\(55\)](#) [MDF7C-11P-2.54DSA\(55\)](#) [MDF7C-18P-2.54DSA\(55\)](#) [MDF7C-5P-2.54DSA\(01\)](#) [MDF7P-5P-2.54DSA\(55\)](#) [75234-0516](#) [FCN-230C068-11](#) [FCN-268F012-G/BD](#) [FCN-268F036-G/BD](#) [FCN-268M012-G/0D](#) [FCN-268M024-G/1D](#) [FCN-360C008-C](#) [FCN-360C040-C](#) [FCN-723J004/1](#) [MIS-048-01-F-D-DP-K](#) [832-10-034-10-001000](#) [93696-325LF](#) [11828-1FA](#) [AXK630345P](#) [18097-0013](#) [ICA-328STT](#) [2007042-2](#) [304400-2](#) [FCN-214Q030-G/0](#) [FCN-215Q040-G/0](#) [FCN-230C068-ESA](#) [FCN-234P048-G/0](#) [FCN-235D050-G/C](#) [FCN-360A3](#) [FCN-360C040-B](#) [210-93-314-41-105000](#) [2-22603-0](#) [379-064-521-202](#) [MDF7-12P-2.54DSA\(01\)](#) [MDF7-16P-2.54DS\(56\)](#) [MDF7-40DP-2.54DSA\(55\)](#) [MDF7-8P-2.54DSA\(55\)](#) [MDF7B-16P-2.54DSA\(55\)](#) [AXG720047](#) [5031084030](#)