

PRODUCT NUMBER  
SEE PART NO. TABLE

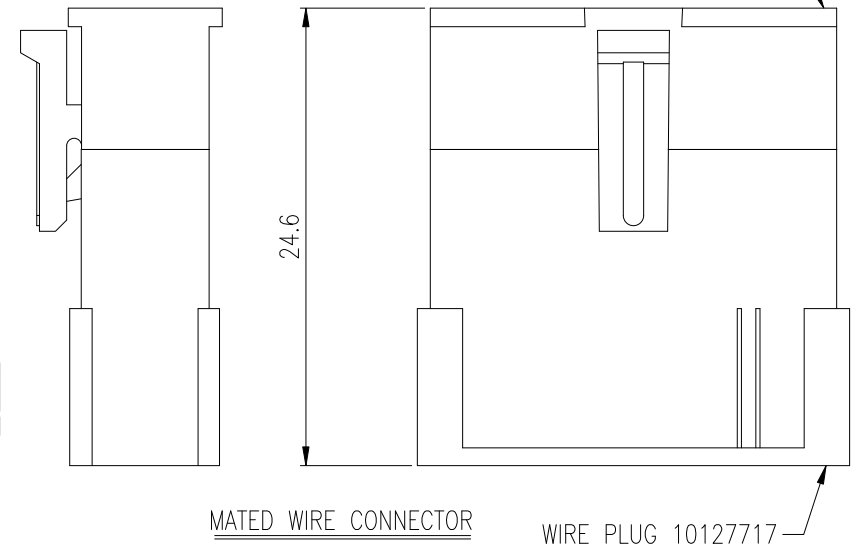
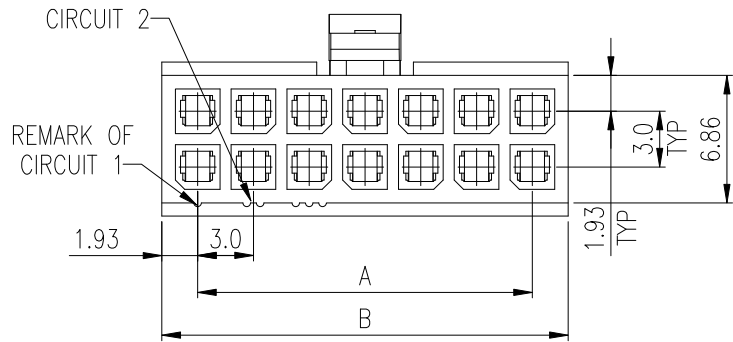
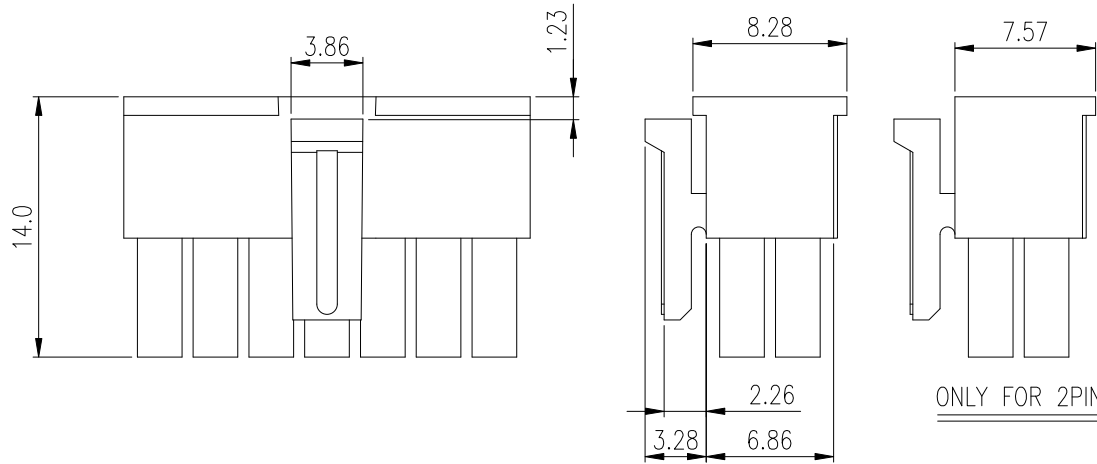
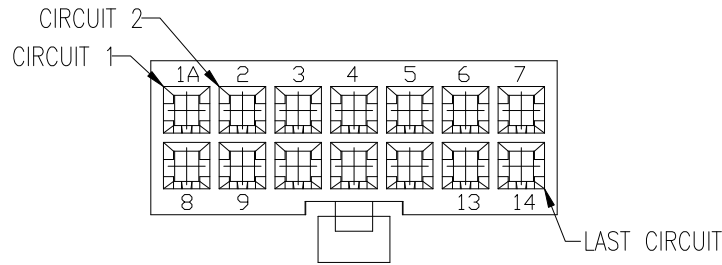

- NOTES:
1. MATERIAL: NYLON 66, UL 94V-0, BLACK.
  2. THIS HSG IS USED WITH FCI RECEPTACLE TERMINAL 10127718.
  3. THIS RECEPTACLE MATES WITH FCI PLUG 10127717, 10127720 & 10127721.
  4. PRODUCT SPECIFICATION: GS-12-1177.
  5. PACKAGE SPECIFICATION: GS-14-2359.
  6. PART NUMBER SCHEME:  
10127716- XX LF

POS. CODE:  
02: 2 POS.  
04: 4 POS.  
5  
24: 24 POS.

DIMENSIONAL & PART NO. TABLE:

PART NO.	POS	A	B
10127716-02LF	2	3.85	3.85
10127716-04LF	4	3.0	6.85
10127716-06LF	6	6.0	9.85
10127716-08LF	8	9.0	12.85
10127716-10LF	10	12.0	15.85
10127716-12LF	12	15.0	18.85
10127716-14LF	14	18.0	21.85
10127716-16LF	16	21.0	24.85
10127716-18LF	18	24.0	27.85
10127716-20LF	20	27.0	30.85
10127716-22LF	22	30.0	33.85
10127716-24LF	24	33.0	36.85

mat'l. code		surface		tolerance		projection		product family	
ltr		ecn no		dr		date		tolerances unless otherwise specified	
A		TAI		2013-10-21		angles		X.X ±0.3	
B		ELX-T-21897		TAI		2015-08-24		X.XX ±0.2	
						X°±2°		scale	
		dr		KENNY TAI		2013-10-21		dwg no	
		enr		KENNY TAI		2013-10-21		sheet 1 of 2	
		chr		KENNY TAI		2013-10-21		size	
		appd		PM ZHENG		2013-11-06		A4	
sheet index		revision sheet		B		B		type	
				1		2		CUSTOMER Drawing	



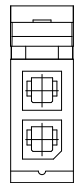

2 POS

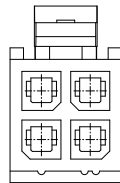

4 POS

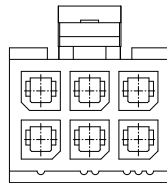

6 POS

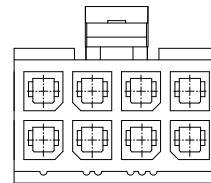

8 POS

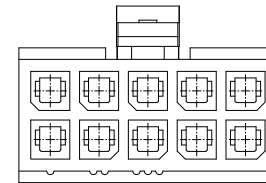

10 POS

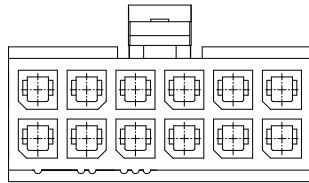

12 POS

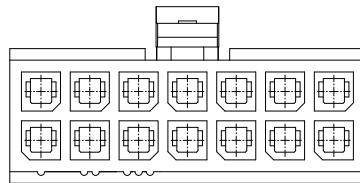

14 POS

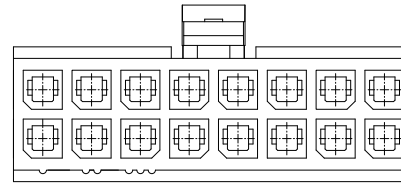

16 POS

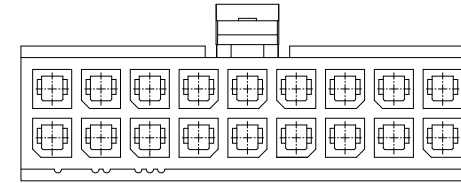

18 POS

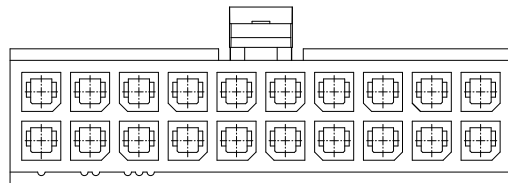

20 POS

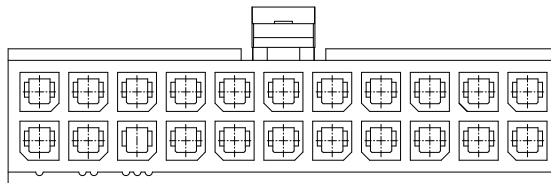

22 POS

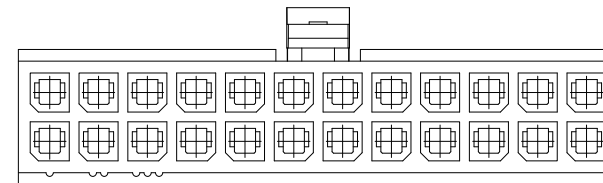

24 POS

mat'l. code		surface <input checked="" type="checkbox"/>		tolerance		projection		product family	
ltr		ecn no		dr		date		title	
								MINITEK PWR3.0 WIRE CONNECTOR, RECEPTACLE HSG, DUAL ROW	
								scale	
								dwg no	
								sheet 2 of 2	
								size	
								A4	
								type	
								CUSTOMER Drawing	
sheet index		revision sheet		B 1		B 2			



## X-ON Electronics

Largest Supplier of Electrical and Electronic Components

*Click to view similar products for [Power to the Board](#) category:*

*Click to view products by [Amphenol](#) manufacturer:*

Other Similar products are found below :

[6450171-4](#) [6450552-7](#) [6600323-8](#) [6643429-1](#) [6646040-2](#) [6651939-1](#) [6766604-1](#) [120959-1](#) [1393557-2](#) [1393532-2](#) [1393532-3](#) [1393532-4](#)  
[1393557-1](#) [1600812-5](#) [1-6450861-2](#) [1744132-7](#) [1761122-1](#) [1766250-1](#) [1892109-1](#) [2-6450860-5](#) [2-6450870-0](#) [1-6450161-4](#) [1-6450850-6](#) [1-6450869-6](#) [1645526-2](#) [1-6600130-0](#) [2005243-2](#) [TE34-12-16P-F0](#) [5-6450830-6](#) [5646956-4](#) [4-6450830-9](#) [4-6600333-3](#) [10125416-4050LF](#)  
[6600320-3](#) [3-6450860-5](#) [1888123-2](#) [6450166-1](#) [6643978-1](#) [6766605-1](#) [N11444](#) [6651938-1](#) [6450810-7](#) [46437-1112](#) [1-1589677-8](#) [5646956-5](#)  
[6450813-2](#) [6450129-4](#) [1645523-1](#) [PSS-06-01-T-S](#) [0465621864](#)