

PRODUCT NUMBER
SEE PART NO. TABLE

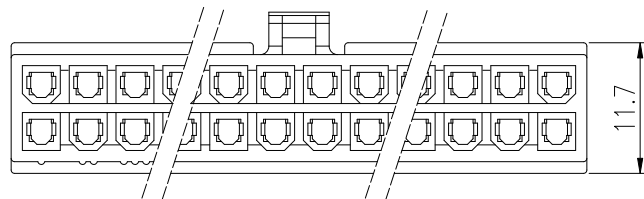
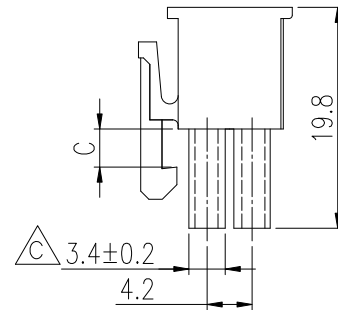
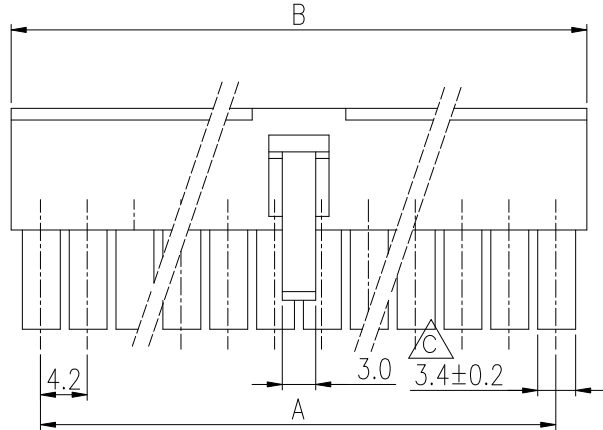
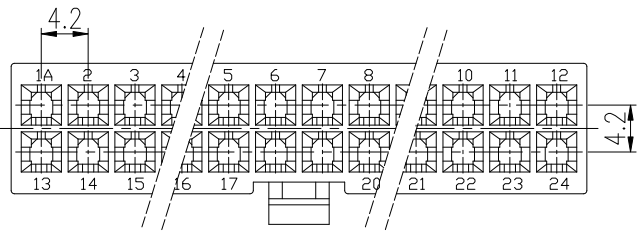
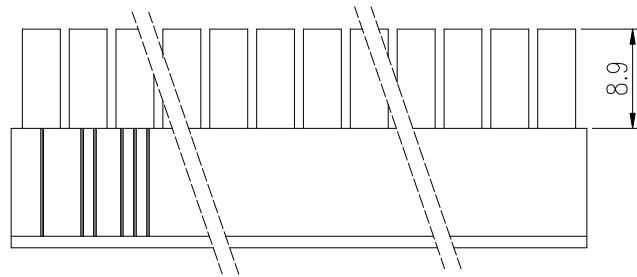

NOTES:

- MATERIAL: NYLON 66, UL94V-0. GLOW WIRE COMPATIBLE
COLOR: NATURAL.
- THIS HSG IS USED WITH FCI RECEPTACLE TERMINAL 10127817.
- THIS RECEPTACLE MATES WITH FCI PLUG 10127816, 10127819 & 10127820.
- PRODUCT SPECIFICATION: GS-12-1181.
- PACKAGE SPECIFICATION: GS-14-2362.
- PART NUMBER SCHEME:
10127815- XX LF

POS. CODE:

- 02: 2 POS.
- 04: 4 POS.
- 24: 24 POS.

7. DIMENSIONAL & PART NO. TABLE:

PART NUMBER	POS.	A	B	C
10127815-02LF	2		5.4	3.30
10127815-04LF	4	4.2	9.6	
10127815-06LF	6	8.4	13.8	
10127815-08LF	8	12.6	18.0	
10127815-10LF	10	16.8	22.2	3.60
10127815-12LF	12	21.0	26.4	
10127815-14LF	14	25.2	30.6	
10127815-16LF	16	29.4	34.8	
10127815-18LF	18	33.6	39.0	
10127815-20LF	20	37.8	43.2	
10127815-22LF	22	42.0	47.4	
10127815-24LF	24	46.2	51.6	

mat'l. code		surface		tolerance	projection	product family	
						MINITEK PWR4.2	
ltr	ecn no	dr	date	tolerances unless otherwise specified		title	
A		TAI	2013-11-11	X.X ±0.4		RECEPTACLE HSG, DUAL ROW	
B	ELX-T-19251	TAI	2014-10-31	X.XX ±0.3		MINITEK PWR4.2 WIRE CONNECTOR	
C	ELX-T-20468	TAI	2015-03-16	X*±1"		scale	
		dr	KENNY TAI	2013-11-11			
		enr	KENNY TAI	2013-11-11			
		chr	KENNY TAI	2013-11-11			
		appd	PM ZHENG	2013-11-22			
sheet	revision	C	C				
index	sheet	1	2				
				FCI		dwg no	
						sheet 1 of 2 size	
						10127815 A4	
						type	
						CUSTOMER Drawing	

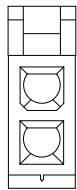

2 POS

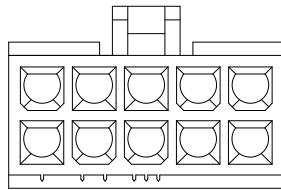

10 POS

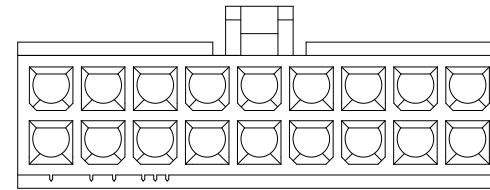

18 POS

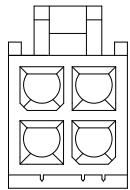

4 POS

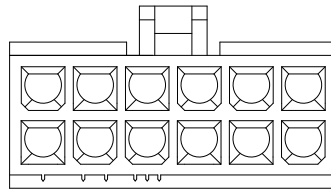

12 POS

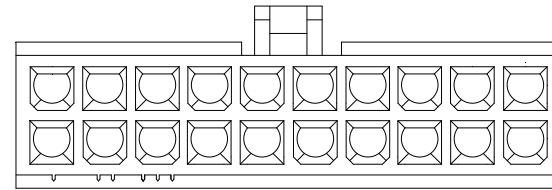

20 POS

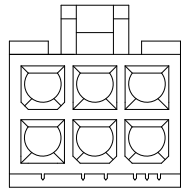

6 POS

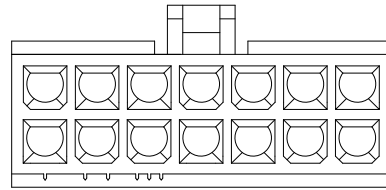

14 POS

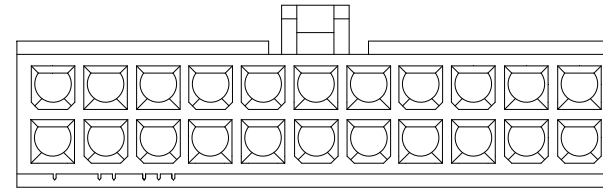

22 POS

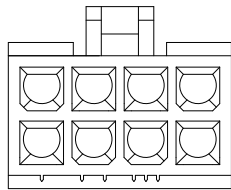

8 POS

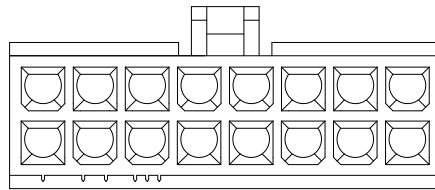

16 POS

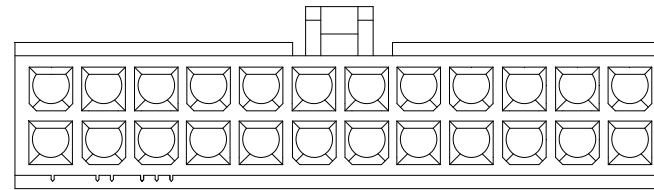

24 POS

mat'l. code		surface <input checked="" type="checkbox"/>		tolerance		projection		product family	
ltr		ecn no		date				MINITEK PWR4.2	
								title	
								RECEPTACLE HSG, DUAL ROW,	
								MINITEK PWR4.2 WIRE CONNECTOR	
								scale	
								dwg no	
								sheet 2 of 2	
								size	
								A4	
								type	
								CUSTOMER Drawing	
sheet index		revision sheet		C 1		C 2			

A

A

B

B

X-ON Electronics

Largest Supplier of Electrical and Electronic Components

Click to view similar products for [Power to the Board](#) category:

Click to view products by [Amphenol](#) manufacturer:

Other Similar products are found below :

[6450171-4](#) [6450552-7](#) [6600323-8](#) [6643429-1](#) [6646040-2](#) [6651939-1](#) [6766604-1](#) [120959-1](#) [1393557-2](#) [1393532-2](#) [1393532-3](#) [1393532-4](#)
[1393557-1](#) [1600812-5](#) [1-6450861-2](#) [1744132-7](#) [1761122-1](#) [1766250-1](#) [1892109-1](#) [2-6450860-5](#) [2-6450870-0](#) [1-6450161-4](#) [1-6450850-6](#) [1-](#)
[6450869-6](#) [1645526-2](#) [1-6600130-0](#) [2005243-2](#) [TE34-12-16P-F0](#) [5-6450830-6](#) [5646956-4](#) [4-6450830-9](#) [4-6600333-3](#) [10125416-4050LF](#)
[6600320-3](#) [3-6450860-5](#) [1888123-2](#) [6450166-1](#) [6643978-1](#) [6766605-1](#) [N11444](#) [6651938-1](#) [6450810-7](#) [46437-1112](#) [1-1589677-8](#) [5646956-5](#)
[6450813-2](#) [6450129-4](#) [1645523-1](#) [PSS-06-01-T-S](#) [0465621864](#)