

SCALE 3:1

TOTAL NUMBER OF POWER CONTACTS AND NUMBER OF SIGNAL CONTACTS	Dim "A"	DIM " B"
2P2S2P	13.0	3.30
2P4S2P	15.0	3.30
2P6S2P	17.0	3.30
2P8S2P	19.0	3.30
2P10S2P	21.0	3.30
2P12S2P	23.0	3.30
4P2S4P	21.4	3.30
4P4S4P	23.4	3.30
4P6S4P	25.4	3.30
4P8S4P	27.4	3.30
4P10S4P	29.4	3.30
4P12S4P	31.4	3.30
6P2S6P	29.8	3.30
6P4S6P	31.8	3.30
6P6S6P	33.8	3.30
6P8S6P	35.8	3.30
6P10S6P	37.8	3.30
6P12S6P	39.8	3.60
8P2S8P	38.2	3.60
8P4S8P	40.2	3.60
8P6S8P	42.2	3.60
8P8S8P	44.2	3.60
8P10S8P	46.2	3.60
8P12S8P	48.2	3.60
2POS0P (2P)	5.0	3.30
2POS2P (4P)	9.6	3.30
2POS4P (6P)	13.8	3.30
4POS4P (8P)	18.0	3.30
4POS6P (10P)	22.2	3.30
6POS6P (12P)	26.4	3.30
6POS8P (14P)	30.6	3.30
8POS8P (16P)	34.8	3.30



Copyright FCI.

PRELIMINARY

spec ref	dr	Jes Wu	2015/01/16	projection	MM	size	A2	scale	5:1
tolerance std	eng	Jes Wu	2015/03/25			ecn no	-	rel level	Preliminary
ISO 406	chr	-	-						
ISO 1101	appr	-	-						
surface	linear	0.X	±0.50	product family	-	rel level	Preliminary	rev	1
ISO 1302	angular	0°	±3°	www.fci.com	cat. no.	10129815	10129815	1	1
Product - Customer Drw						sheet 1 of 2			

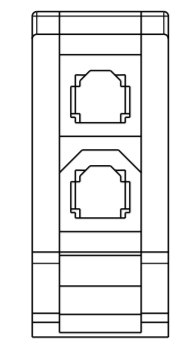

2POS0P (2P)

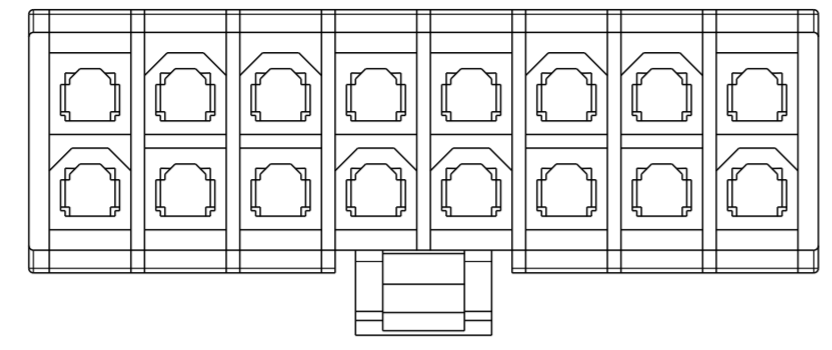

8POS8P (16P)

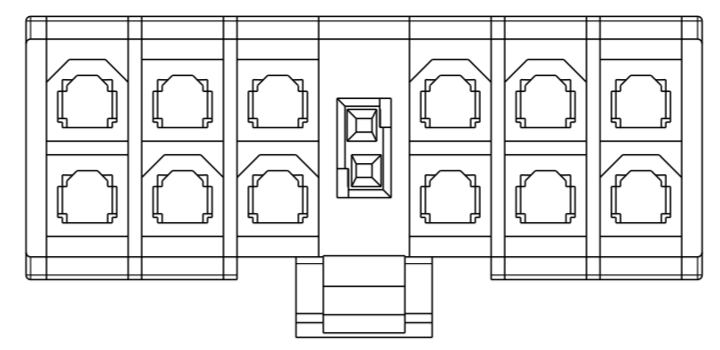

6P2S6P

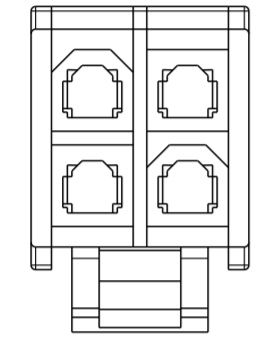

2POS2P (4P)

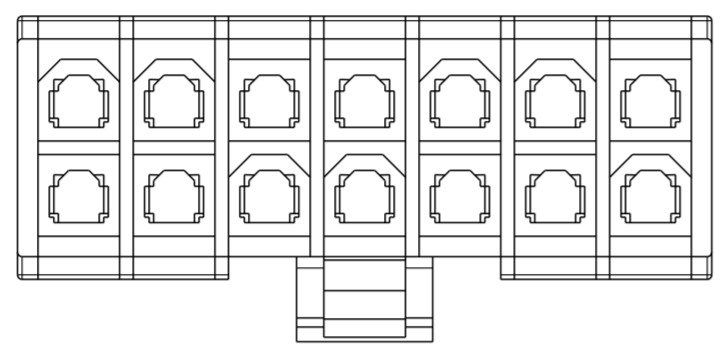

6POS8P (14P)

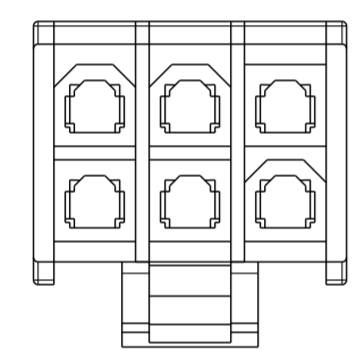

2POS4P (6P)

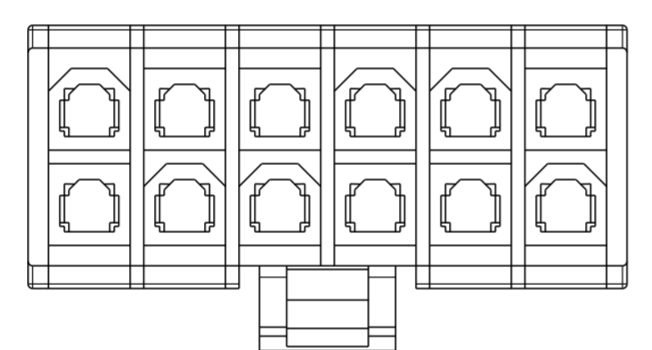

6POS6P (12P)

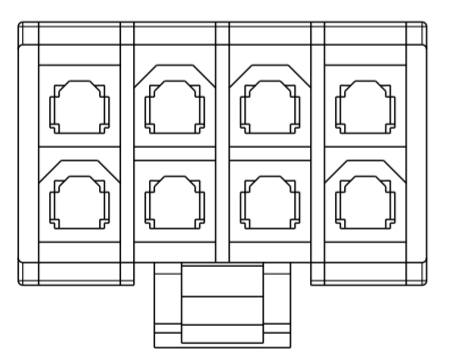

4POS4P (8P)

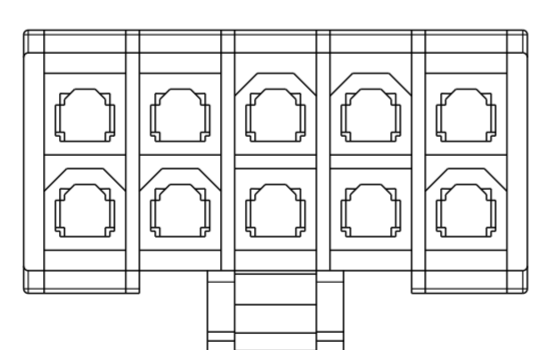

4POS6P (10P)

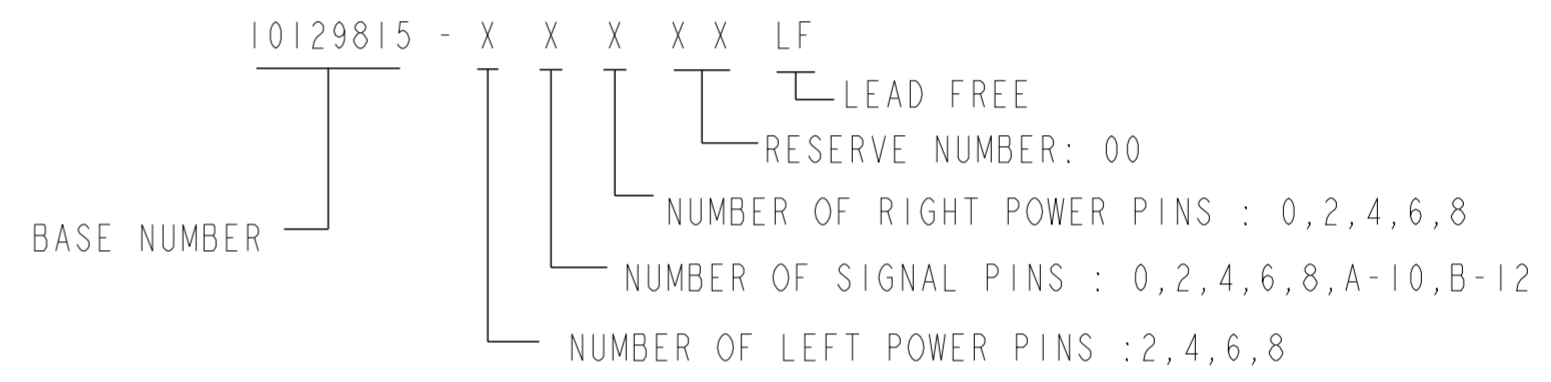

- 3 NOTES:
- MATERIALS:
NYLON 6/6 , UL94V-0, COLOR: NATURE
 - PRODUCT SPECIFICATION: GS-12-1288.
 - APPLICATION SPECIFICATION: GS-20-0438.
 - PACKAGING SPECIFICATION: GS-14-2450.

POWER PIN LAYOUT (WITH OR WITHOUT SIGNAL PINS)

Copyright FCI. FCI

spec ref	dr	Jes Wu	2015/01/16	projection	MM	size	A2	scale	5:1
tolerance std	eng	Jes Wu	2015/03/25			ecn no	-	rel level	Preliminary
ISO 406	chr	-	-						
ISO 1101	appr	-	-	product family	-	rel level	-	rev	1
surface	linear	0.X	±0.50			title Minitek Pwr Hybrid 4.2mm REC HSG ASSY		dwg no 10129815	sheet 2 of 2
ISO 1302	angular	0°	±3°	www.fci.com	cat. no.	Product - Customer Drw	rev	1	sheet 2 of 2

X-ON Electronics

Largest Supplier of Electrical and Electronic Components

Click to view similar products for [Power to the Board](#) category:

Click to view products by [Amphenol](#) manufacturer:

Other Similar products are found below :

[6450171-4](#) [6450552-7](#) [6600323-8](#) [6643429-1](#) [6646040-2](#) [6651939-1](#) [6766604-1](#) [120959-1](#) [1393557-2](#) [1393532-2](#) [1393532-3](#) [1393532-4](#)
[1393557-1](#) [1600812-5](#) [1-6450861-2](#) [1744132-7](#) [1761122-1](#) [1766250-1](#) [1892109-1](#) [2-6450860-5](#) [2-6450870-0](#) [1-6450161-4](#) [1-6450850-6](#) [1-](#)
[6450869-6](#) [1645526-2](#) [1-6600130-0](#) [2005243-2](#) [TE34-12-16P-F0](#) [5-6450830-6](#) [5646956-4](#) [4-6450830-9](#) [4-6600333-3](#) [10125416-4050LF](#)
[6600320-3](#) [3-6450860-5](#) [1888123-2](#) [6450166-1](#) [6643978-1](#) [6766605-1](#) [N11444](#) [6651938-1](#) [6450810-7](#) [46437-1112](#) [1-1589677-8](#) [5646956-5](#)
[6450813-2](#) [6450129-4](#) [1645523-1](#) [PSS-06-01-T-S](#) [0465621864](#)