

PRODUCT NUMBER
SEE PART NO. SCHEME

- NOTE:
 1. MATERIAL:
 HOUSING: NYLON 66, HALOGEN FREE
 UL94V-0, COLOR: BLACK
 2. REFER GS-20-0399 APPLICATION SPECIFICATION
 FOR MATING CONNECTOR.
 3. PRODUCT SPECIFICATION: GS-12-1177.
 4. PACKAGE SPECIFICATION: GS-14-2359 (BULK PACKED)
 5. APPLICATION SPECIFICATION: GS-20-0399.
 6. LEAD FREE PRODUCTS MEET EUROPEAN UNION
 DIRECTIVES AND OTHER COUNTRY REGULATIONS AS
 DESCRIBED IN GS-47-0004
 7. PART NUMBER SCHEME:
 10136653- XX X LF

NO OF POS
 02: 2 POS.
 }
 12: 12 POS.

LEAD FREE
 GLOW WIRE COMPATIBLE
 BLANK: NON COMPATIBLE
 G: COMPATIBLE

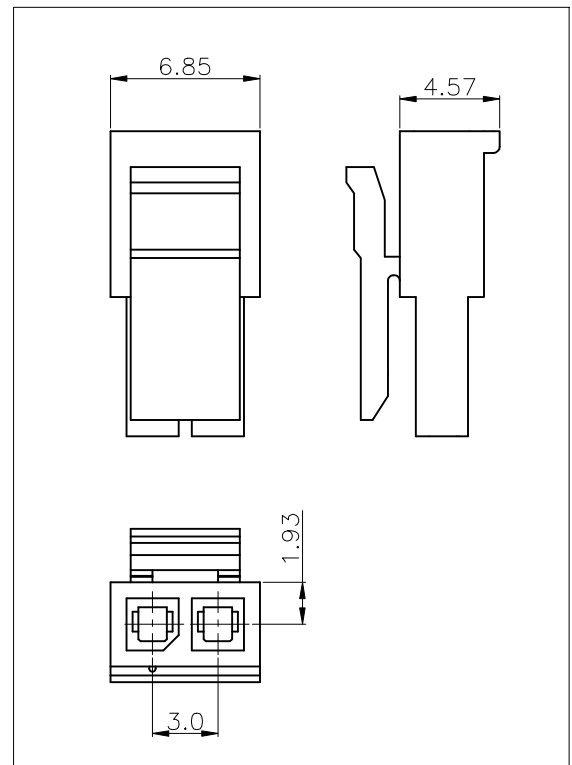
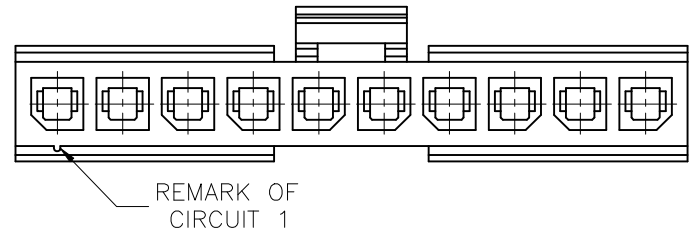
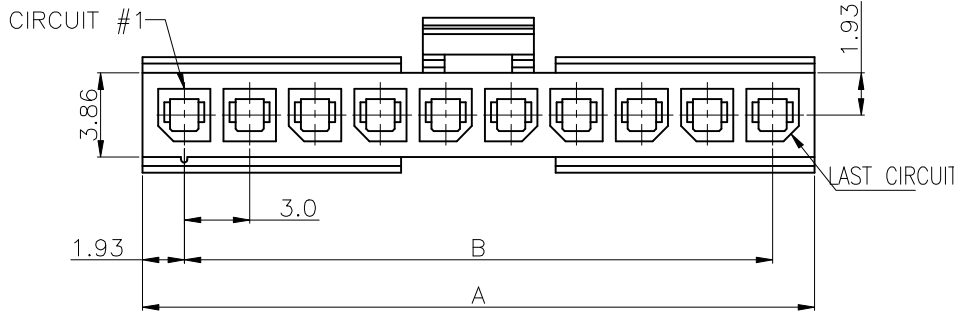
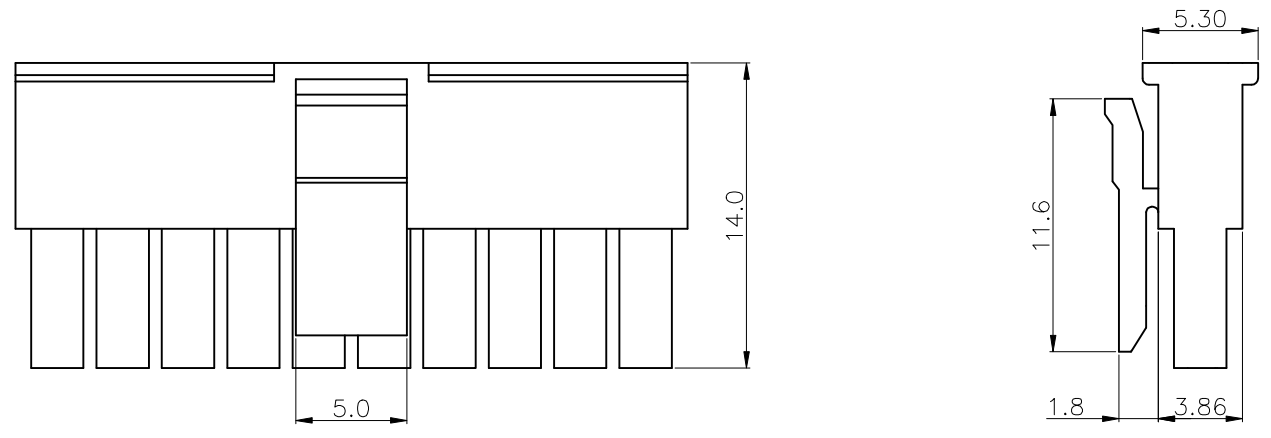

(2 CIRCUIT HOUSING)

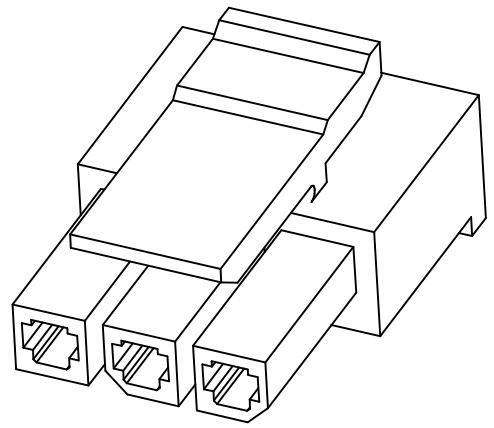

PART NO.	POS.	A	B
10136653-02XLF	02		3.00
10136653-03XLF	03	9.85	6.00
10136653-04XLF	04	12.85	9.00
10136653-05XLF	05	15.85	12.00
10136653-06XLF	06	18.85	15.00
10136653-07XLF	07	21.85	18.00
10136653-08XLF	08	24.85	21.00
10136653-09XLF	09	27.85	24.00
10136653-10XLF	10	30.85	27.00
10136653-11XLF	11	33.85	30.00
10136653-12XLF	12	36.85	33.00

mat'l. code				surface	tolerance	projection	product family
ltr				ISO 1302	ISO 406	ISO 1101	MINITEK PWR3.0
ecn no				tolerances unless otherwise specified		mm	title
dr				angles	linear		
date				0°±3'		scale	N.T.S
A -- TAI 2015-09-23						MINITEK PWR3.0 WIRE CONNECTOR, RECEPTACLE HSG, SINGLE ROW	
B ELX-T-24691 TAI 2016-08-10						dwg no	
C ELX-N-27430 TONY 2017-07-10						sheet 1 of 2	
D ELX-I-43460 ASLAM 2022-01-17						size	
						A3	
						type	
						Product Customer Drawing	
sheet index		revision sheet		D D			
		1 2					

Amphenol FCI

© 2016 AFCI



© 2016 AFCI

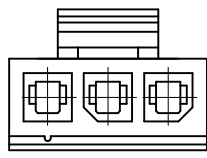

3 POS

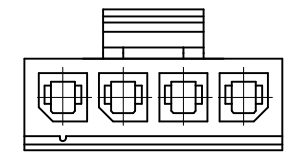

4 POS

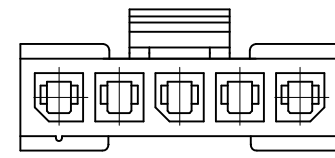

5 POS

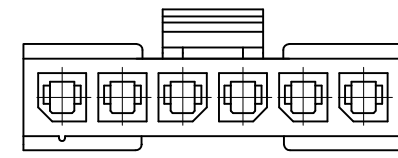

6 POS

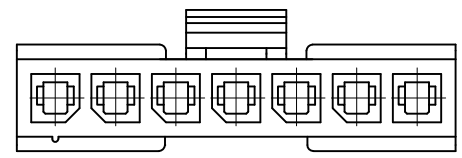

7 POS

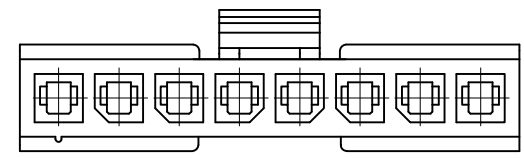

8 POS

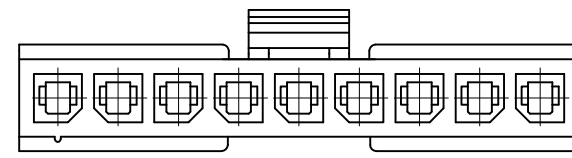

9 POS

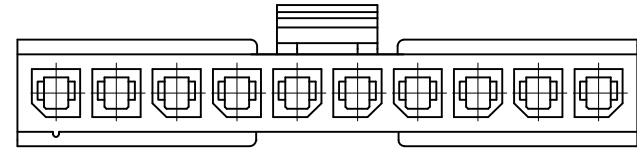

10 POS

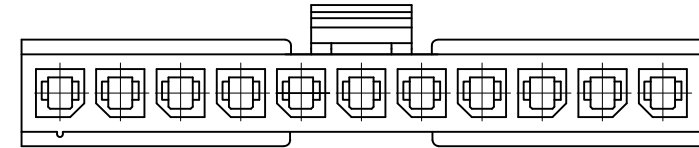

11 POS

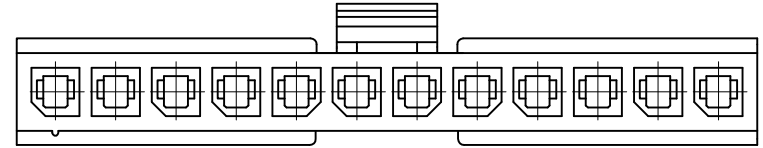

12 POS

mat'l. code				surface	tolerance	projection	product family				
				ISO 1302	ISO 406 ISO 1101	 mm	MINITEK PWR3.0				
ltr				tolerances unless otherwise specified			title				
ecn no				angles		 N.T.S	MINITEK PWR3.0 WIRE CONNECTOR,				
dr				linear			RECEPTACLE HSG, SINGLE ROW				
date				0°±3'		dwg no					
				dr		KENNY TAI		sheet 2 of 2		size	
				engr		AKHIL RAJAN		10136653		A3	
				chr		MITHUN PAUL		type		Product Customer Drawing	
				appd		SPK					
sheet index		revision sheet		D	D						
		1 2									

X-ON Electronics

Largest Supplier of Electrical and Electronic Components

Click to view similar products for [Headers & Wire Housings](#) category:

Click to view products by [Amphenol](#) manufacturer:

Other Similar products are found below :

[0015917161](#) [0022155065](#) [57102-F02-18ULF](#) [58102-G61-06LF](#) [582553-1](#) [01.001.5753.1](#) [0050291907](#) [02.125.8002.8](#) [609-3404](#) [61062-3](#)
[CSU011177004](#) [622-0430](#) [622-3653LF](#) [63453-116](#) [636-1030](#) [636-1427](#) [636-3427](#) [636-4007](#) [641938-9](#) [644827-2](#) [65495-038](#) [65692-001LF](#)
[65781-018](#) [65781-047](#) [65817-010LF](#) [65817-015LF](#) [67095-007LF](#) [67601157](#) [68631-112](#) [68645-018](#) [699319-000](#) [70.362.1628.0](#) [70-4210](#) [70-](#)
[4226B](#) [70-4853B](#) [71.350.2428.0](#) [733-134](#) [733-162](#) [760-3052](#) [MHR-64-VUAL](#) [80.063.4001.1](#) [800-90-001-10-001000](#) [801-43-002-10-013000](#)
[801-43-006-10-002000](#) [803-43-024-10-001000](#) [803-93-012-10-001000](#) [8-1437020-4](#) [819-22-004-30-001101](#) [820-22-006-30-001101](#)
[821-22-002-10-001101](#)